

61-18. Repealed by State Register Volume 39, Issue No. 6, Doc. No. 4468, eff June 26, 2015.

Editor's Note

Former R. 61-18 was titled **Drugs and Devices**.

61-19. Vital Statistics.

(Statutory Authority: 1976 S.C. Code Sections 44-63-10 et seq.)

TABLE OF CONTENTS

SECTION 100—DEFINITIONS

SECTION 200—SYSTEM OF VITAL STATISTICS

SECTION 300—SECURITY AND CONFIDENTIALITY OF SYSTEM OF VITAL STATISTICS

301. General

302. Preservation of Vital Records and Vital Reports

303. Confidentiality

304. Disclosure of Information from Vital Records or Vital Reports for Health Research

SECTION 400—RECORDS AND REPORTS

401. Forms, Records, Reports, and Electronic Data Files

402. Requirements for Preparation of Records and Reports

403. Persons Required to Retain Documentation

404. Duties to Furnish Information

405. Content of Vital Records and Vital Reports

SECTION 500—LIVE BIRTH REGISTRATION

501. General

502. Out-of-Institution Live Births

503. Abandoned Infants

SECTION 600—DELAYED REGISTRATION OF BIRTHS

601. General

602. Documentary Evidence Requirements

603. Documentary Evidence Acceptability

604. Abstraction of Documentary Evidence

605. Verification by the State Registrar

606. Dismissal after One Year

607. Delayed Birth Records Amended by Court Order

608. Establishment of Delayed Birth Certificate by Court Order

SECTION 700—DEATH REGISTRATION

701. General

702. Judicial Procedures to Register a Death

SECTION 800—FETAL DEATH REGISTRATION

SECTION 900—DISPOSITION AND TRANSPORTATION OF HUMAN REMAINS

901. Permits Governing Disposal or Transportation of Dead Human Bodies

902. Removal of Body

903. Authorization for Disinterment and Reinterment

904. Disposition of Body or Fetus by Hospital Officials Authorized by Next of Kin

SECTION 1000—REPORTS OF INDUCED TERMINATION OF PREGNANCY

SECTION 1100—CORRECTION AND AMENDMENT OF VITAL RECORDS

1101. General

1102. Correction of Birth and Death Records

1103. Administrative Amendment of Birth and Death Records

1104. Documentary Evidence Required to Amend Birth and Death Records

1105. Addition of Registrant's Names on Live Birth Records

1106. Date of Birth Amendments to Live Birth Records

1107. Amendments to Marital Status on Death Records

1108. Amendments to Also Known As ("a/k/a") Names on Death Certificates

1109. Sealed Amendments and Replacement Records of Live Birth

1110. Amendments by Court Order

1111. Administrative Amendments to Parental Titles

1112. Amendment of the Same Certification Item More than Once

SECTION 1200—CERTIFICATIONS FROM THE SYSTEM OF VITAL STATISTICS

SECTION 1300—FEES

100. DEFINITIONS

For the purpose of this regulation, the following definitions shall apply:

- A. Amendment. A change to a certification item.
 - (1) Administrative Amendment. An amendment to a certification item on a vital record without the need of a court order, using documentary evidence, an affidavit form created by the Bureau of Vital Statistics, and other administrative requirements of the Bureau of Vital Statistics.
 - (2) Sealed Amendment. A change to a birth record after an adoption, statutory maternity or paternity process, or other amendment required by law to be placed in a sealed file. A replacement record is created and the original record is sealed.
 - (3) Amendment by Court Order. A change to a certification item on a vital record based on a court order.
- B. Birth Mother. The woman who gives live birth to a child.
- C. Book Copy. A certified image of the original birth certificate.
- D. Certification. The document issued by the Department and containing all or a part of the exact information contained on the original vital record, and which, when issued by the Department, has the full force and effect of the original vital record.
- E. Certification Item. Any item of information that appears on a certification.
- F. Certifier. A person required to attest to the accuracy of the information submitted on a vital event report.
- G. Correction. A change to rectify a mistake on a birth or death record or a report of fetal death based on the original information used to register the record or report.
 - (1) Administrative Correction. A correction to a certification item on a vital record without the need of a court order, using documentary evidence and an application approved by the Bureau of Vital Statistics.
 - (2) Correction by Court Order. A change to a certification item on a vital record based on a court order.
- H. Court of Competent Jurisdiction. A court within the United States with jurisdiction over the subject matter and over the necessary parties.
- I. Date of Registration. The month, day, and year a vital event is incorporated into the official records of the Bureau of Vital Statistics.
- J. Dead Body. A human body or such parts of a human body from the condition of which it reasonably may be concluded that death has occurred.
- K. Department. The South Carolina Department of Health and Environmental Control (DHEC).
- L. Disclosure. Making available or making known personally identifiable information contained in a vital record or vital report, by any means of communication.
- M. Electronic Signature. An electronic sound, symbol, or process attached to or logically associated with a contract or other record and executed or adopted by a person with the intent to attest to the accuracy of the facts in the record.
- N. Facts of Live Birth. The child's name, date of birth, place of birth and sex, and the name(s) of parent(s) appearing on the record of live birth.
- O. Fetal Death. Death prior to the complete expulsion or extraction from its birth mother or gestational carrier of a product of human conception, irrespective of the duration of pregnancy and which is not an induced termination of pregnancy. The death is indicated by the fact that after such expulsion or extraction, the fetus does not breathe or show any other evidence of life, such as beating of the heart, pulsation of the umbilical cord, or definite movement of voluntary muscles. Heartbeats are to be distinguished from transient cardiac contractions; respirations are to be distinguished from fleeting respiratory efforts or gasps.
- P. Final Disposition. The burial, interment, cremation, removal from the state, or other authorized disposition of a dead body or fetus.

Q. Gestational Carrier. A woman carrying and delivering a child through a formal written agreement for assisted reproduction and when she is not the intended parent of the child.

R. Government Agency. A unit of local, state, federal, or tribal government.

S. Health Research. A systematic study to gain information and understanding about health with the goal of finding ways to improve human health, conducted in accordance with generally accepted scientific standards or principles and designed to develop or contribute to generalizable scientific knowledge.

T. Human Remains. A dead body, or any part of the body of a human being from the condition of which it reasonably can be concluded that death occurred but does not include human ashes recovered after cremation.

U. Individual. A natural person.

V. Induced Termination of Pregnancy. The purposeful interruption of an intrauterine pregnancy with the intention other than to produce a live-born infant, and which does not result in a live birth. This definition excludes management of prolonged retention of products of conception following fetal death.

W. Informant. The person who provides demographic and personal information as required for the report of death.

X. Institution. Any establishment, public or private, which provides:

- (1) in-patient or out-patient medical, surgical, or diagnostic care or treatment; or
- (2) nursing, custodial, or domiciliary care; or
- (3) to which persons are committed by law.

Y. Interment. The disposition of human remains by entombment or burial.

Z. Legal Representative. A licensed attorney representing the registrant or other entitled applicant.

AA. Live Birth. The complete expulsion or extraction from its birth mother or gestational carrier of a product of human conception, irrespective of the duration of pregnancy, which, after such expulsion or extraction, breathes, or shows any other evidence of life, such as beating of the heart, pulsation of the umbilical cord, or definite movement of voluntary muscles, whether or not the umbilical cord has been cut or the placenta is attached. Heartbeats are to be distinguished from transient cardiac contractions; respirations are to be distinguished from fleeting respiratory efforts or gasps.

BB. Medical Certifier. A licensed physician, physician assistant (PA), advanced registered nurse (APRN), coroner, medical examiner, or other officer authorized by S.C. law or regulation to certify the cause and manner of death on a death certificate who has treated the decedent through examination, medical advice, or medications within the twelve (12) months preceding the death for the illness or condition which resulted in death as defined in S.C. Code Section 44-63-74(3).

CC. Midwife. A person licensed by the State of South Carolina who provides midwifery services as defined in Regulation 61-24, Licensed Midwives.

DD. Natural Burial. The interment of the body of a dead person in the soil in a manner that does not inhibit decomposition but allows the body to be naturally recycled. The body is neither cremated nor prepared with chemicals such as embalming fluids. The body may be placed in a biodegradable coffin or shroud and interred without a concrete burial vault.

EE. Next of Kin/Immediate Family Member. The decedent's surviving spouse, adult children, parents, siblings, grandparents, or grandchildren.

FF. Original Birth Certificate for Adoptees. A copy of the sealed original birth certificate issued to adoptees according to S.C. Code Section 44-63-140. The non-certified copy is issued on plain white paper and may not be used for legal purposes.

GG. Person Serving as Funeral Director (Other Agent). An individual who chooses to handle final disposition and filing of the death record of a deceased family member or friend without compensation and without the services of a licensed funeral director. Transportation companies cannot serve as a funeral director or other agent unless specified by the State Registrar or Assistant State Registrar.

HH. Personally Identifiable Information. Information that can be used to distinguish or trace an individual's identity, such as, but not limited to, his or her name, Social Security number, biometric

records or address, alone, or when combined with other personal or identifying information which is linked or linkable to a specific individual, such as, but not limited to, date and place of live birth or mother's name prior to first marriage.

II. Person in Charge of an Institution. The officer or employee who is responsible for administration and includes, but is not limited to, a person holding the title of chief executive officer, administrator, superintendent, director or executive director.

JJ. Physician. A person authorized or licensed to practice medicine or osteopathy pursuant to the laws of this state.

KK. Record. A report of a vital event that has been registered by the Department.

LL. Registration. The process by which reports are accepted and incorporated into the official records of the Bureau of Vital Statistics.

MM. Report. A document, paper or electronic, containing information related to a vital event submitted by a person or entity required to submit the information in accordance with this regulation to the Bureau of Vital Statistics for the purpose of registering a vital event.

NN. Sealed File. The original record of a vital event that has been sealed after amendment and the evidence submitted to support the change. Sealed files shall not be subject to inspection, except upon order of the Family Court.

OO. State Registrar. The officer tasked by state law with carrying into effect the regulations and orders of the Department related to Vital Statistics. All duties and responsibilities relating to Vital Statistics may be delegated at his discretion to the Assistant State Registrar.

PP. System of Vital Statistics. The collection, registration, preservation, amendment, certification, verification, and the maintenance of the security and integrity of vital records; the collection of other reports required by this regulation; and activities related thereto including the tabulation, analysis, publication, and dissemination of vital statistics.

QQ. User. Any individual with access to or responsibility for data entry into the Vital Statistics system.

RR. Verification. A confirmation of the information contained in a vital record.

SS. Vital Event. A live birth, death, fetal death, marriage, divorce, annulment, or induced termination of pregnancy.

TT. Vital Records. Reports of live birth, death, marriage, divorce, or annulment and data related thereto which have been accepted for registration and incorporated into the official records of the Bureau of Vital Statistics.

UU. Vital Reports. Reports of fetal death and induced terminations of pregnancy which have been accepted for registration and incorporated into the Department's vital statistics.

VV. Vital Statistics. The aggregated data derived from the records and reports of live birth, death, fetal death, induced termination of pregnancy, marriage, divorce, or annulment and supporting documentation and related reports.

200. SYSTEM OF VITAL STATISTICS

A. The State Registrar may establish, designate, or eliminate offices in the state to aid in the efficient administration of the system of vital statistics. The Assistant State Registrar shall be the Director of the Bureau of Vital Statistics.

B. The State Registrar and Assistant State Registrar may delegate such functions and duties vested in them to employees of the Bureau of Vital Statistics and to employees of any office established or designated under Section 200.A.

C. The System of Vital Statistics shall:

- (1) be directed and supervised by the State Registrar who shall be custodian of its records.
- (2) be uniform in policy and procedure throughout the state.

D. Public health programs within the Department may be provided copies of or data derived from vital records and vital reports required under this regulation, as the State Registrar determines are necessary for public health planning and program activities. The copies or data shall remain the

property of the Bureau of Vital Statistics, and the uses shall be governed by the State Registrar as allowed by law.

300. SECURITY AND CONFIDENTIALITY OF SYSTEM OF VITAL STATISTICS

301. General.

All users of the system of vital statistics shall:

- A. complete authentication procedures as required by the Bureau of Vital Statistics and only access the components of the system necessary for their official roles and duties and as allowed by law;
- B. maintain specified levels of training related to security and acknowledge in writing security procedures and penalties;
- C. allow validation of data provided in reports submitted for registration through site visits by Department staff at a frequency specified by the State Registrar to maximize the integrity of the data reported;
- D. secure their workplace, storage and technology environments to protect all personally identifiable information; and
- E. acknowledge in writing the procedures to identify and report to the Department any breach of the system of vital statistics.

302. Preservation of Vital Records and Vital Reports.

Records or reports registered with the Department shall be reproduced and preserved as determined appropriate by the State Registrar. Such reproductions when verified and approved by the State Registrar shall be accepted as the original vital record documents. The original vital record documents from which permanent reproductions have been made may be disposed of as provided by retention schedules.

303. Confidentiality.

A. Vital records, vital reports, indices, related documents, and data or information contained therein shall be confidential.

(1) No person shall permit inspection of, or disclose data or information contained in vital records, vital records related documents, or in vital reports, except as specifically allowed by law.

(2) No person shall copy or issue a copy of all or part of any such record or report except as specifically allowed by law.

B. To protect the confidentiality and security of vital records and vital reports, access to or disclosure of information contained in vital records for sale or release to the public, for direct or indirect marketing of goods or services, for solicitation of registrants or families of registrants (unless explicitly allowed by law), or for other commercial or speculative purposes shall not be deemed a proper purpose.

304. Disclosure of Information from Vital Records or Vital Reports for Health Research.

A. Each request for vital records and reports data to be used for health research or other informational purposes shall be submitted in accordance with the Department's public health data release policies and procedures.

B. Any requestor will be required to sign a data release agreement that:

(1) prohibits the re-release of any information, unless specifically allowed in the data release agreement;

(2) restricts use of the data for the specified purpose;

(3) specifies that ownership of vital records and vital report data provided under the data release agreement remains with the Bureau of Vital Statistics;

(4) specifies applicable data suppression rules to protect confidentiality when the number of cases is small enough that reidentification is possible; and

(5) defines variables classified as confidential and non-releasable variables.

Variables will be classified as restricted, confidential, or non-releasable by the Director of the Bureau of Vital Statistics.

400. RECORDS AND REPORTS

401. Forms, Records, Reports, and Electronic Data Files.

All forms, records, electronic data files, reports, and supporting documentation used in the system of vital statistics are the property of the Department and shall be surrendered upon demand. The forms prescribed and distributed by the Department for reporting vital events shall be used only for official purposes. Only those forms, including worksheets used in the preparation of records or reports, furnished or approved by the State Registrar shall be used for the submission of records and reports or in certifications thereof. Electronic data records will be accepted only when standards set by the State Registrar are met. Only computer programs specified and provided or otherwise authorized by the State Registrar shall be used for the submission of records and reports.

402. Requirements for Preparation of Records and Reports.

A. All individuals preparing, submitting, or certifying a vital event shall be trained or approved by the Bureau of Vital Statistics.

B. All forms, records, and reports relating to vital events must either be computer printed, typewritten, or printed legibly in black, unfading ink, or generated using electronic media approved by the State Registrar.

C. All signatures required shall be either electronic or entered in black, unfading ink.

D. Unless otherwise directed by the State Registrar, a report shall only be acceptable for registration when it:

- (1) contains the certifier's name computer printed, typed, or printed legibly;
- (2) supplies all items of information or satisfactorily accounts for their omission;
- (3) does not contain alterations or erasures;
- (4) does not interfere with document imaging;
- (5) contains signatures as required;
- (6) has no marks or flags such as "copy" or "duplicate";
- (7) is an original;
- (8) is prepared on the proper form;
- (9) does not contain improper or inconsistent data;
- (10) does not contain an indefinite cause of death, which denotes only symptoms of disease or conditions resulting from disease;
- (11) is prepared in conformity with regulations or instructions issued by the Department; and
- (12) does not contain false information.

403. Persons Required to Retain Documentation.

A. Every person in charge of an institution shall retain documentation of personal data as required for the reports of live birth, death, fetal death, or induced termination of pregnancy required by this regulation. The documentation shall include information provided by the person being admitted or confined, but when it cannot be so obtained, the information shall be obtained from relatives or other persons acquainted with the facts. The name and address of the person providing the information shall be a part of the documentation.

B. Any licensed health care provider shall retain documentation of personal data concerning each person under the provider's care for a condition that results in a reportable vital event when such documentation is not maintained by an institution described in Section 403.A. The documentation shall include such information as required for the provider to submit a report of live birth, death, fetal death, or induced termination of pregnancy required by this regulation. The documentation shall include information provided by the person being treated. If the person being treated cannot provide the information, then the licensed health care provider shall obtain the information from relatives or other persons acquainted with the facts. The name and address of the person providing the information shall be a part of the documentation.

C. When a dead body or fetus is released or disposed of by an institution, the person in charge of the institution shall retain documentation showing the name of the decedent, date of death, name and address of the person to whom the body or fetus is released, and the date of removal from the

institution. If final disposition is made by the institution, the date, place, and manner of disposition shall also be documented.

D. A funeral director, embalmer, or other person who removes from the place of death, transports, or makes final disposition of a dead body or fetus, in addition to filing any record or other report required by law or regulations, shall retain documentation which shall identify the body, and the following information pertaining to his or her receipt, removal, delivery, burial, or cremation of such body:

- (1) The date, place, and time of receipt;
- (2) The date, place, and manner of disposition;
- (3) If the dead body or fetus is delivered to another funeral director, the date of such delivery and the name and address of the funeral director to whom delivered; and
- (4) The demographic and personal data collected from the informant as required by the report of death for those deaths for which the funeral director was required to register the report.

E. Documentation maintained under this section shall be retained for a period of not less than one (1) year and shall be made available for inspection by the State Registrar or his or her representative upon demand.

404. Duties to Furnish Information.

A. Upon demand of the Department, any person having knowledge of the facts shall furnish such information as he or she may possess regarding any live birth, death, fetal death, induced termination of pregnancy, marriage, divorce, or annulment. Any person required to report shall provide to the Department information that was required to be reported, but that was not so reported, within five (5) calendar days of that person receiving that information.

B. Within five (5) calendar days of receipt of any autopsy results or other information that would provide pending or missing information or correct errors in a reported cause of death, the physician, medical examiner, or coroner required to report the death shall register a supplemental report of the cause of death to amend the record.

C. The State Registrar or designee shall have the authority to require alternative documentation from the data provider of the occurrence of vital events for the purpose of quality assurance.

405. Content of Vital Records and Vital Reports.

A. In order to promote and maintain nationwide uniformity in the system of vital statistics, the forms of vital records and vital reports required by law, or by regulations, shall include as a minimum the items recommended by the National Center for Health Statistics or its successor agency.

B. Each vital record, vital report, and other document required by this regulation shall be prepared in the format approved by the State Registrar.

C. All vital records and vital reports shall contain the date of registration.

D. Information required in forms, vital records, or vital reports authorized by this regulation may be submitted, verified, registered, and stored by photographic, electronic, or other means as prescribed by the Department.

500. LIVE BIRTH REGISTRATION

501. General.

A. A report of live birth for each live birth which occurs in this state shall be submitted to the Bureau of Vital Statistics, or as otherwise directed by the State Registrar, within five (5) calendar days after such live birth and shall be registered if it has been completed and submitted in accordance with this section.

B. The physician, institution, or other person providing prenatal care shall provide the prenatal care information required for the report to the institution where the delivery is expected to occur not less than thirty (30) calendar days prior to the expected delivery date. Any subsequent prenatal care information shall be submitted to the institution prior to submission of report of live birth.

C. When a live birth occurs in an institution or en route thereto, the person in charge of the institution or his or her authorized designee shall obtain all data required by the Department, prepare the report, certify that the child was born alive at the place and time and on the date stated either by

signature or by an approved electronic process, and submit the report within the required five (5) calendar days.

D. In obtaining the information required for the report, all institutions shall use information gathering procedures, including worksheets, provided or approved by the State Registrar. Institutions may establish procedures to transfer, electronically or otherwise, information required for the report from other systems. Such procedures shall be reviewed and approved by the State Registrar prior to implementation to ensure that the information being transferred is the same as that being requested for the report.

E. When a live birth occurs outside an institution:

(1) the information for the report of live birth shall be submitted in the format specified by the Department and in the following order of priority within five (5) calendar days of the live birth by:

- (a) the medical institution at which the birth mother or gestational carrier and child are examined within five (5) calendar days of the live birth; or
- (b) a licensed midwife or physician in attendance at the live birth; or
- (c) the birth mother with documentary evidence as described in Section 502; or
- (d) the coroner in cases where investigation is required.

(2) an order from a South Carolina Family Court shall be required to register a live birth when the report submitted does not include the minimum acceptable documentation required in the regulations or the State Registrar has cause to question the validity or adequacy of the documentary evidence.

F. When a live birth occurs on a moving conveyance within the United States and the child is first removed from the conveyance in this state, the live birth shall be registered in this state and the place where it is first removed shall be considered the place of live birth. When a live birth occurs on a moving conveyance while in international waters or air space or in a foreign country or its air space and the child is first removed from the conveyance in this state, the live birth shall be registered in this State, but the report shall show the actual place of live birth insofar as can be determined.

G. For purposes of live birth registration and maternity determination:

(1) The woman who gives live birth to the child shall be recorded as the birth mother and the information required by the report of live birth shall be that of the birth mother, except as required by Section 501.G(4);

(2) A court of competent jurisdiction may determine that a woman other than the live birth mother is the biological or genetic mother and order that the original live birth record be so replaced in accordance with Section 1109. The original live birth record shall then be placed under seal.

(3) In the context of birth through gestational carrier, Sections 501.G(1) and G(2) above shall apply for recording the parentage information, unless the intended parent or parents have obtained a pre-birth order from a court of competent jurisdiction. The pre-birth order establishing parentage may be acceptable when the order is issued no more than six (6) months prior to the expected due date and contains all of the following information:

- (a) The full name and date of birth of the gestational carrier;
- (b) The expected due date and intended name of the child;
- (c) The intended hospital of birth;
- (d) A finding of no parental rights to the child of the gestational carrier and her spouse, if married; and
- (e) The full names (including names prior to first marriage), dates of birth, state of birth (or country, if foreign born), and any other necessary information of the intended parents to create the birth certificate.

(4) In the context of birth through a gestational carrier agreement in which a pre-birth order is obtained, the institution will record information from both the gestational carrier and the intended parent(s) when filing the birth certificate.

H. Up to two (2) individuals may be listed as the parents on a certificate of live birth. Paternity/second parent shall be determined as follows:

(1) If the birth mother was married at the time of either conception or live birth, or between conception and live birth, the name of the spouse shall be entered on the report as the second parent of the child.

(2) If the birth mother was not married at the time of either conception or live birth or between conception and live birth, the name of the father shall not be entered on the report without an Acknowledgment of Paternity on a form developed by the Department and as prescribed by state law and signed by the birth mother and the person to be named as the father. The Acknowledgment shall be filed with the Department.

(3) If the second parent is not named on the report of live birth, no information about that second parent will be entered on the report.

(4) Thereafter, paternity or second parentage of a child may be determined by a court of competent jurisdiction pursuant to South Carolina law. The name of the father or second parent and surname of the child shall be entered on the report of live birth in accordance with the finding of the court when a valid court order is submitted to the Bureau of Vital Statistics. The original live birth record shall then be placed under seal.

I. The birth mother of the child or, in the case of a gestational carrier, the intended parents and gestational carrier shall verify the accuracy of the personal data to be entered on the report to permit the submission of the report within the five (5) calendar days as prescribed in Section 501.A.

(1) If the birth mother or gestational carrier is incapacitated or deceased, the legal spouse, or other informant as determined appropriate by the State Registrar shall provide and verify the accuracy of the information.

(2) If the birth mother, the legal spouse, or other informant does not verify the accuracy of the personal data entered within the prescribed five (5) days, the report of live birth shall be filed without verification.

(3) A child's name may not include more characters than is allowed in the system for registration and may not include types of characters not allowed by the system for registration utilized by the Bureau of Vital Statistics for the purpose of registering birth records.

J. Reports of live birth submitted after five (5) calendar days, but within one (1) year from the date of live birth shall be registered in the standard format of live birth reports in the manner prescribed above. Such reports shall not be marked or flagged "Delayed."

K. The State Registrar may require additional evidence in support of the facts of live birth.

502. Out-of-Institution Live Birth.

A. When a live birth occurs in this state outside of an institution, and there is found to be no live birth registration and the report of live birth is to be registered before the first birthday, additional evidence in support of the facts of live birth may be required.

B. For an unattended birth when the birth mother is responsible for submitting the report of live birth, the following documentary evidence is required:

(1) Evidence of pregnancy from a licensed medical professional;

(2) Evidence created within (5) calendar days of the date of live birth from a licensed medical professional showing that the infant was born alive;

(3) Evidence of the birth mother's presence in this state on the date of the live birth; and

(4) Other evidence acceptable to the State Registrar.

C. When the State Registrar has cause to question the validity or adequacy of the documentary evidence submitted for an out-of-institution live birth, the report of live birth shall not be registered without an order from a South Carolina Family Court establishing the facts of birth.

503. Abandoned Infants.

A. When an abandoned infant, including a baby surrendered pursuant to S.C. Code Section 63-7-40, is brought to an emergency room or to an institution, the person in charge of the institution shall submit the report of live birth within five (5) calendar days of discovery to the Bureau of Vital Statistics with the following information:

- (1) The date and city and/or county of discovery;
 - (2) Sex and approximate live birth date of child as determined by a physician or licensed health care provider;
 - (3) Name and address of the person or institution submitting this report;
 - (4) Name given to the child by the custodian of the child, if applicable; and
 - (5) Other data required by the State Registrar.
- B. The place where the child was found or discovered shall be entered as the place of live birth.
- C. Information submitted under this section shall constitute the basis for the report of live birth for the child.
- D. The report for an abandoned infant shall be registered in the current format for live births and shall:
- (1) have foundling plainly marked or flagged on the report;
 - (2) show the required facts as determined by approximation and have parentage data left blank; and
 - (3) show the name and title of the person or institution submitting the report under section 503.A.
- E. If the child is identified and a live birth registration is found or obtained, the report submitted under this Section and any live birth registration resulting from that report shall be voided and placed in a sealed file and shall not be subject to inspection except upon order of a South Carolina Family Court or by the Department for purposes of administering the vital statistics program.
- F. For purposes of this section, when an abandoned child does not meet the definition of “infant” in S.C. Code Section 63–7–40, a court order shall be required to file a report of live birth. The court order shall establish the facts of birth in Section 503.A.
- G. Birth Records registered under this Section that contain the parents’ information shall not be issued except to the S.C. Department of Social Services for the purposes of adoption or care for the child.

600. DELAYED REGISTRATION OF BIRTHS

601. General.

- A. The following minimum facts must be established by documentary evidence:
- (1) the full name of the person at the time of live birth;
 - (2) the date of live birth;
 - (3) that the live birth occurred in South Carolina;
 - (4) the full name of the birth mother prior to first marriage; and
 - (5) the full name of the father/parent if parents were married at the time of birth. Otherwise, the name of the father/parent shall not be entered on the delayed certificate unless:
 - (a) the child has been adopted or legitimized, or
 - (b) the paternity has been determined by a court of competent jurisdiction or an Acknowledgment of Paternity accompanies the establishment of the delayed certificate.
- B. All delayed births are to be filed on a special “delayed certificate of birth” form adopted by the Department.
- C. Each delayed certificate of birth established administratively shall be signed by the person whose birth is to be filed if of legal age and is competent to swear to the accuracy of the facts stated therein; otherwise, the certificate shall be signed by a parent or legal guardian.

602. Documentary Evidence Requirements.

To be acceptable for registration, the name of the person at the time of the live birth and the date and place of live birth entered on a delayed registration of live birth shall be supported by at least:

- A. Three (3) pieces of acceptable documentary evidence that will establish to the satisfaction of the State Registrar the facts and date of live birth as alleged in the application; and
- B. Facts of parentage shall be supported by at least one (1) document.

603. Documentary Evidence Acceptability.

A. The acceptability of all documentary evidence submitted shall be determined by the State Registrar.

B. Documents must be from independent sources and shall be in the form of the original record or a duly certified copy thereof or a signed statement from the custodian of the record or document.

C. All documents submitted in evidence:

(1) For persons more than seventeen (17) years of age, must have been established at least ten (10) years prior to the date of application;

(2) For persons seventeen (17) years of age or younger, must be dated at least one (1) year prior to the date of application; and

(3) Shall not be contradictory.

D. Documents may include, but are not limited to:

(1) Census Records;

(2) Hospital or Medical Records;

(3) Military Records;

(4) Social Security Numident Reports;

(5) Voter registration application;

(6) School records; or

(7) Other documents as designated by the State Registrar.

E. When the State Registrar finds reason to question the validity or adequacy of any evidence submitted, he or she may reject the evidence and advise the applicant of the reasons for this action.

604. Abstraction of Documentary Evidence.

A. The Vital Statistics employee preparing the certificate shall abstract on the delayed registration of live birth a description of each document submitted to support the facts. This description shall include:

(1) the title or description of the document;

(2) the name and address of the custodial organization;

(3) the creation date of the original document; and

(4) all live birth facts required by Section 601 contained in each document accepted as evidence.

B. Original documents submitted in support of the delayed birth registration shall be returned to the applicant after review. After a delayed birth certificate has been registered with the state, convenience copies of all accepted documents on file with the Bureau of Vital Statistics shall be destroyed.

605. Verification by the State Registrar.

The State Registrar, or his or her designated representative, shall verify:

A. That no prior report of live birth is registered in this state for the person whose live birth is to be recorded;

B. That he or she has reviewed the evidence submitted to establish the facts of live birth; and

C. That the abstract of the evidence appearing on the delayed birth certificate accurately reflects the nature and content of the document.

606. Dismissal After One Year.

An application for a delayed registration birth certificate that has not been completed within one (1) year from the date of application may be dismissed at the discretion of the State Registrar. The Department shall so advise the applicant and documents submitted in support of such application shall be returned to the applicant.

607. Delayed Birth Records Amended by Court Order.

A live birth originally registered as a delayed live birth shall remain in the delayed birth certificate format, regardless of subsequent legal change of status or amendment. The amended certificate will clearly indicate the information changed by court order and be marked as amended by court order.

Any certification of such record shall notate the items changed by the court order and the date the change was made.

608. Establishment of Delayed Birth Certificate by Court Order.

When the evidence submitted does not satisfy the above requirements, the applicant may petition a court of competent jurisdiction to establish a delayed birth certificate pursuant to S.C. Code Section 44-63-100.

700. DEATH REGISTRATION

701. General.

A. A report of death for each death which occurs in this state shall be submitted to the Bureau of Vital Statistics, or as otherwise directed by the State Registrar, within five (5) calendar days after death or the finding of a dead body and shall be registered if it has been completed and submitted in accordance with this section.

(1) If the place of death is unknown but the dead body is found in this state, the report of death shall be completed and submitted in accordance with this section. The place where the body is found shall be noted as the place of death.

(2) When death occurs in a moving conveyance within the United States and the body is first removed from the conveyance in this State, the death shall be registered in this state and the place where it is first removed shall be deemed the place of death. When a death occurs on a moving conveyance while in international waters or air space or in a foreign country or its air space and the body is first removed from the conveyance in this State, the death shall be registered in this State, but the report shall show the actual place of death insofar as can be determined.

(3) If the date of death is unknown, the medical certifier shall determine the date by approximation. If the date cannot be determined by approximation, the date found shall be entered and identified as date found.

B. The funeral director or person acting as such who first assumes custody of the dead body shall submit the report of death to the Bureau of Vital Statistics. In cases where there is no funeral director or person acting as such, the coroner shall submit the report of death. In no event shall a transport company file a death record.

(1) The funeral director or person acting as such shall obtain the personal data from the next of kin or the best qualified person or source available and shall obtain the medical certification from the person responsible, therefore.

(2) The funeral director or person acting as such shall provide the report of death containing sufficient information to identify the decedent to the medical certifier within forty-eight (48) hours after death unless the medical certification has already been submitted.

(3) In cases where the family chooses not to engage the services of a licensed funeral director, they may dispose of the body by way of a natural burial as defined in Section 100 of this regulation. In such cases, the person listed on the Burial-Removal-Transit Permit (BRTP) as first assuming custody or handling the final disposition of the body shall also be responsible for submitting the report of death to the Bureau of Vital Statistics. If no report is filed within thirty (30) calendar days after the date of death and the Bureau has been unsuccessful in contacting the person listed as responsible for the disposition of the body via the means of contact listed on the BRTP form, they shall file the certificate with the available information.

(4) Medical certifiers or their staff should review cases of deceased individuals designated to them at least once each business day. The medical certification shall be completed within forty-eight (48) hours, excluding weekends and federal or state holidays, after receipt of notice of the death by the decedent's primary or attending physician, except when inquiry is required by S.C. Code Section 44-43-720. In the absence or inability of said medical certifier, or with his or her approval, the report may be completed by his or her associate physician, physician's assistant, or APRN, the chief medical officer of the institution in which death occurred, or the physician who performed an autopsy upon the decedent, provided such individual has access to the medical history of the case, and death is due to natural causes. The person completing the cause of death shall attest to its accuracy either by signature or by an approved electronic process.

(5) When inquiry is required by S.C. Code Section 44-43-720, the coroner or medical examiner in the jurisdiction where death or injury occurred or where the body was found shall determine the cause and manner of death and shall complete and sign the medical certification within forty-eight (48) hours after taking charge of the case. If the cause and/or manner of death cannot be determined within forty-eight (48) hours, the cause and/or manner of death shall be entered as pending and a supplemental medical amendment shall be submitted when the cause and/or manner of death is determined.

(6) Administrative penalties as defined in S.C. Code Section 44-63-74 shall be assessed whenever a death certificate is filed more than five (5) calendar days after the date of death. The Department shall review each record filed late to determine whether the funeral home or director, medical certifier (excluding coroners and medical examiners), or both are at fault for the delay of registration.

(a) When fault for the delay of registration is determined by the Department, the party or parties determined to be at fault shall be emailed a notice of violation by the Department and informed of the total amount of the administrative penalty. The funeral home, funeral director, or medical certifier may submit a statement or evidence showing good cause for the delay up to fifteen (15) calendar days after the notice is sent from the Department. If no statement or evidence of good cause is submitted within fifteen (15) calendar days, the party determined at fault will be sent an official notice of the fine assessed via certified mail.

(b) If a statement or evidence is submitted claiming good cause for the delay, the Department shall make a determination within fifteen (15) calendar days whether the good cause is justified. Good cause shall include, but not be limited to, the following: (1) a natural disaster, (2) an emergency declaration from the Governor, (3) a verified system malfunction or error reported within the specified timeframe, (4) when significant but unsuccessful efforts were made to file the record on time, or (5) when the funeral director is unable to obtain information pursuant to S.C. Code Section 44-63-74(A)(2)(a). In cases where there were significant but unsuccessful efforts to file the record on time, the person responsible for registration shall notify the Department via email within the specified timeframe with the cause of the delay. In cases where the decedent's information cannot be obtained pursuant to S.C. Code Section 44-63-74(A)(2)(a), a statement from the informant listed on the death certificate must be submitted stating the reason for the inability to collect the information for good cause to be considered. The Department shall notify the party whether or not good cause is determined within fifteen (15) calendar days after final review of the evidence. If the Department determines good cause is present, fines will be reduced or removed.

(c) If the Department determines that the evidence submitted does not establish good cause for the delay, the party or parties determined at fault will receive a final notice of violation via email and certified mail that the evidence for good cause has been denied and the fines will be due. Administrative penalties assessed should be paid within thirty (30) calendar days of the final notice being sent. If the fines are paid within the thirty (30) calendar days of the final notice, the party at fault will be eligible for a fifty percent (50%) reduction of fines. If the fees are not paid within thirty (30) calendar days of the final notice, the entire amount due must be paid.

C. When a court of competent jurisdiction determines a death has occurred within this state but the body cannot be located, a death certificate may be prepared by the Department upon receipt of an order of the court, which shall include the finding of facts required to complete the death record, including, but not limited to, the county of death. Such a death record shall be marked "presumptive" and shall show on its face the date of filing and shall identify the court and the date of the decree.

D. When a death occurring in this state has not been registered as prescribed by this section, a report of death may be submitted to the Department using the current format of the report of death provided the medical certifier at the time of death and the funeral director or person acting as such are available to complete the report of death. If the medical certifier at the time of death and the funeral director or person acting as such are unavailable or decline then the death shall not be registered except upon receipt of an order from a court with competent jurisdiction. If the report of death is submitted more than one (1) year after the date of death, the record shall be marked as "delayed" and any certified copy shall be marked as such. If the date of death cannot be determined, the record shall be filed with the date the body was found as the date of death.

E. In obtaining the information required for the report, funeral directors or persons acting as such shall use information gathering procedures, including worksheets, provided or approved by the Department. Medical Certifiers may establish procedures to transfer, electronically or otherwise, information required for the medical certification from other systems. Such procedures shall be reviewed and approved by the State Registrar prior to implementation to ensure that the information being transferred is the same as that being requested for the report.

F. In cases where the coroner or medical examiner is providing the non-medical information for report of death, any supplemental non-medical information shall be submitted by the coroner or medical examiner on the approved worksheet form with the Department within five (5) calendar days after such information is obtained. The supplemental information shall be incorporated into the existing death record in accordance with S.C. Code Section 44-63-74.

702. Judicial Procedures to Register a Death.

A death may be registered by the Department, upon receipt of an order of a court of competent jurisdiction within this state.

A. The court order to establish a death record shall include all of the following information:

- (1) decedent's legal name (first, middle, surname and suffix, if any);
- (2) date of death as determined from the evidence presented;
- (3) place of death, including county, as determined from the evidence presented;
- (4) decedent's date of live birth, state or country of live birth, sex and parent(s) name(s) prior to first marriage;
- (5) decedent's residence, including county and state, at time of death;
- (6) decedent's marital status at time of death;
- (7) name, prior to first marriage, of surviving spouse (if any); and
- (8) the information necessary to complete the medical certification including the cause and manner of death. If the death occurred from an injury, information on how and when the injury occurred. If such information is unknown, the order shall indicate such.

B. All certifications issued shall show the date of the court order and the name of the court issuing that order.

C. If the death was registered pursuant to Section 701.C, the record shall be marked or flagged "Presumptive."

800. FETAL DEATH REGISTRATION

A. A report of each fetal death of 350 grams or more, or if weight is unknown, of twenty (20) completed weeks gestation or more, based on clinical estimate of gestation at delivery, which occurs in this state shall be submitted within five (5) calendar days after delivery to the Bureau of Vital Statistics or as otherwise directed by the State Registrar and shall be registered if it has been completed and submitted in accordance with this Section. All induced terminations of pregnancy shall be reported in the manner prescribed in Section 1000 and shall not be reported as fetal deaths.

B. When a fetus is delivered in an institution or en route thereto, the person in charge of the institution, or his or her designated representative, shall obtain all data required by the Department to prepare and submit the report. In obtaining the information required by the fetal death report, all institutions shall use information-gathering procedures including worksheets provided or approved by the State Registrar. Institutions may establish procedures to transfer, electronically or otherwise, information required by the fetal death report from other systems. Such procedures shall be reviewed and approved by the State Registrar prior to implementation to ensure that the information being transferred is the same as that being requested on the fetal death report.

C. When a fetus is delivered outside an institution and then taken to an institution, the institution shall prepare and submit the report.

D. When a fetal death required to be reported by this Section occurs outside of an institution and the fetus is not taken to an institution immediately after the delivery or when inquiry is required by state law, the coroner shall investigate the cause of fetal death and shall prepare and submit the fetal death report within five (5) calendar days of notification.

E. If the cause of fetal death is unknown or pending investigation, the cause of fetal death shall be noted as such on the fetal death report.

F. When a fetal death occurs in a moving conveyance and the fetus is first removed from the conveyance in this state or when a fetus is found in this state and the place of fetal death is unknown, the fetal death shall be reported in this state. The place where the fetus was first removed from the conveyance or the fetus was found shall be considered the place of fetal death.

G. Reports of fetal death are statistical reports to be used only for public health purposes. Such reports shall be disposed of when all statistical processing of the reports has been accomplished. However, the Department may establish a data file of such reports so they will be available for future research and such file may be retained for as long as the State Registrar deems necessary.

900. DISPOSITION AND TRANSPORTATION OF HUMAN REMAINS

901. Permits Governing the Disposal or Transportation of Dead Human Bodies.

A. The subregistrar or the coroner in the county in which the death occurred shall issue a Burial-Removal-Transit Permit (BRTP) within forty-eight (48) hours after death or the next business day. If the body is found more than forty-eight (48) hours after death, the BRTP shall be filed within forty-eight (48) hours after the body is found.

B. The funeral director, or person acting as such, who first assumes custody of a dead body or fetus shall obtain a BRTP prior to final disposition or removal of the body or fetus from the State. BRTPs may be emailed, hand delivered, or faxed to a funeral home or company that first takes possession of the body. If a funeral home or transportation company is not participating in the electronic system to receive the BRTP via email, the permit must be printed and delivered to them via one of the aforementioned methods.

C. A BRTP issued under the law of another state which accompanies a dead body or fetus into this state shall be authority for final disposition of the body or fetus in this state.

902. Removal of Body.

Before taking charge of a dead human body or fetus, the funeral director or person acting as such shall:

A. Contact the medical certifier and receive assurance from him or her that death is from natural causes and that the medical certifier will assume responsibility for certifying to the cause of death; or

B. Contact the coroner if the case comes within his or her jurisdiction and receive authorization from him or her to remove the body.

903. Authorization for Disinterment and Reinterment.

A. Except as otherwise provided by statute, a permit for disinterment and reinterment of human remains shall be required prior to disinterment of a dead body or fetus. If the dead body or fetus is being reinterred in the same plot where it was originally interred, a permit shall not be required.

B. A disinterment permit shall be issued only upon receipt of the form prescribed by the State Registrar signed by the next of kin and the person who is to perform the disinterment or upon receipt of an order of a court of competent jurisdiction directing such disinterment. The permit shall be permission for disinterment, transportation, and reinterment. The disinterment must be performed within one (1) year of the date permission was granted by the State Registrar or designee, otherwise the applicant must apply for a new permit. The Department may destroy any copies of permits issued but not returned within one (1) year of the date permission was granted.

C. Human remains deposited in a receiving vault shall not be considered a disinterment when removed from the vault for final disposition.

D. The funeral director to whom the permit is issued shall retain a copy. A copy shall be used during transportation and filed with the sexton or person in charge of the cemetery of reinterment. The funeral director shall return a copy to the Bureau of Vital Statistics showing the date of reinterment.

E. The permit requirement of this section shall not apply to disinterment or reinterment of a dead body or fetus when death occurred before 1915.

F. Certified copies of completed disinterment permits may be issued to any next of kin of the deceased or the firm authorized to perform the disinterment upon receipt of an application and

payment for a record search as defined in Section 1300. No other parties shall be issued copies of the completed disinterment permit except upon order from a court of competent jurisdiction.

904. Disposition of Body or Fetus by Hospital Officials Authorized by Next of Kin.

Hospital officials who dispose of bodies of persons or fetuses dead of natural causes, with legal permission of the next of kin and not for hire or profit, are responsible for filing the record of fetal death or of death. In all cases, including a reportable fetal death, a Burial Removal Transit Permit must be obtained for the disposition of the remains.

1000. REPORTS OF INDUCED TERMINATION OF PREGNANCY

A. Each induced termination of pregnancy which occurs in this state, regardless of the length of gestation, shall be reported to the Bureau of Vital Statistics within seven (7) calendar days by the person in charge of the institution in which the induced termination of pregnancy was performed. If the induced termination of pregnancy was performed outside an institution, it shall be reported by the attending medical provider.

B. Reports of induced termination of pregnancy are statistical reports to be used only for public health purposes. Such reports shall be disposed of when all statistical processing of the reports has been accomplished. However, the Department may establish a data file of such reports so they will be available for future research and such file may be retained for as long as the State Registrar deems necessary.

C. When a late fee is assessed pursuant to S.C. Code Section 44-41-460(D), the institution shall be eligible for a fifty percent (50%) reduction of fees if the fee is paid in full within thirty (30) calendar days. If the fee is not paid in full within thirty (30) calendar days, the full amount due must be paid.

1100. CORRECTION AND AMENDMENT OF VITAL RECORDS

1101. General.

A. Live birth records are presumed to contain accurate information on the facts of live birth when they are registered. Live birth records will be amended or corrected only to rectify errors in the facts of live birth, except as provided for in this regulation.

B. A delayed record of live birth placed on file with supporting documentation or by judicial procedure shall not be amended except to reflect changes upon receipt of a certified court order.

C. Certificates of marriage and reports of divorce must be corrected by the custodian of the official record from which the report was prepared. The custodian shall submit the amended certificate to the Department with a statement listing the items changed and evidence presented to support each certification item changed. Any corrected records shall be marked amended when issued by the Department.

D. Except as specifically allowed by law, sealed records and their accompanying documents are not subject to reproduction by any means, including, but not limited to, photography or photocopying, and shall not be subject to inspection except upon order of the Family Court. The State Registrar or their designee may inspect such information for purposes of properly administering the vital statistics program.

E. Changes to birth or death records must be requested by a person entitled by law to obtain a certified copy of the record to be amended.

F. If paternity is rescinded pursuant to S.C. Code Section 63-17-50, the signatory's name will not be removed from the record of live birth except upon receipt of an order from a court of competent jurisdiction terminating the parental rights of the father and ordering the Department to remove the father's information.

1102. Correction of Birth and Death Records.

A. Any certification item on a live birth or death record may be corrected by the Bureau of Vital Statistics within one (1) year of the event if the Bureau of Vital Statistics becomes aware of incorrect information on a record. Any institution or individual responsible for the original submission of data shall assist in the collection of evidence of the error and correct information upon request of the Bureau of Vital Statistics. Evidence submitted in support of a correction is subject to approval by the State Registrar.

B. When the demographic portion of a death certificate is filed by a coroner due to the inability to contact the family to select a funeral home, the death certificate may be corrected to update any incorrect demographic information and to list the funeral home selected upon submission of a funeral home worksheet and the signed contract with the family.

C. Correction of items that do not appear on certifications may be made by the Bureau of Vital Statistics upon identification or query.

D. When such corrections are made by the Bureau of Vital Statistics, a notation as to the source of the information, the date the change was made, and the identity of the authorized vital statistics employee making the change shall be made on the record in such a way as not to become a part of any certification issued. Any certified copy shall not be marked as "Amended."

1103. Administrative Amendment of Birth and Death Records.

A. Unless otherwise provided in this regulation or in statute, all administrative amendments to live birth and death records shall be supported by documentary evidence and a notarized affidavit. The notarized affidavit shall be on a form created by the Bureau of Vital Statistics setting forth:

- (1) information to identify the record;
- (2) the items to be amended;
- (3) the incorrect information as it appears; and
- (4) the correct information as it should appear and supported by documentary evidence.

B. To amend a live birth record, an application shall be initiated and signed by the parents, the legal guardian, or the registrant if eighteen (18) years of age. Amendments to the registrant's information on a birth record, if eighteen (18) years of age or older, must be signed by the registrant unless the registrant is incapacitated or deceased. Affidavits to amend the information on a birth record for deceased individuals may be signed by the decedent's next of kin with adequate supporting documentation.

C. To amend demographic certification items on a death record, an affidavit of amendment shall be signed by the informant or, in the case of the death or incapacity of the informant, the adult next of kin of the deceased.

D. The medical certification items on a death record may only be amended upon receipt of a signed statement or approved electronic notification from the medical certifier who originally certified the cause of death. In the absence or inability of the medical certifier, the cause of death may be amended upon receipt of a signed statement or an approved electronic notification from his or her duly authorized medical associate, or the chief medical officer of the institution in which death occurred, or a medical examiner, or coroner who assumes jurisdiction of the case. The Department may require documentary evidence to substantiate the requested amendment.

E. Upon acceptance of the requested amendment by the Department, records of live birth and death shall be amended by the Department by adding the new information to the record in a manner that preserves the existing information for audit purposes.

F. Amended records shall be marked as "Amended" on certifications of the record. The date of the change and what item was changed shall also be shown on certifications of the record except on certifications of the record in cases of sealed amendments as described in Section 1109.

1104. Documentary Evidence Required to Amend Birth and Death Records.

A. With the exception of corrections as outlined in Section 1102, or an amendment to the medical certification, one or more items of documentary evidence must be presented that support the alleged facts. All documents presented must contain sufficient information to clearly indicate that they pertain to the registrant on the record for which the amendment or correction has been requested.

(1) Documents presented must be from independent sources. Family documents that are not independently filed by a government entity, such as records from bibles or genealogical records, are not acceptable.

(2) Documents must be in the form of the original record or must be a duly certified copy or excerpt thereof from the original custodian of the record and may not contain alterations of any kind, including strike out, whiteout, or other forms of alteration unless approved by the State Registrar.

(3) For live birth records, the earliest evidence available is preferable to show consistency of use. In general, documents submitted must have been established prior to the registrant's eighteenth (18th) birthday or at least ten (10) years prior to the date of application for the amendment unless otherwise specified by the State Registrar. For amendments to the registrant's information, the evidence submitted must contain the full name of the registrant and at least one (1) other identifier such as the date of birth or age.

(4) For death records, the evidence submitted to support an address change must have been established within one (1) year prior to death unless otherwise specified by the State Registrar. For amendments to other certification items on the death record:

(a) Signatures and signatories shall not be amended;

(b) Other personal and statistical items on the death record shall be amended with supporting documentary evidence that is acceptable to the State Registrar.

(c) The informant's name may only be amended to correct minor errors in spelling without an order from a court of competent jurisdiction.

B. Documents for other certification items will be accepted at the discretion of the State Registrar or their designee.

C. The State Registrar or their designee shall evaluate the evidence submitted in support of any amendment, and when he or she finds reason to doubt its validity or adequacy, the amendment may be rejected and the applicant advised of the reason(s).

1105. Addition of Registrant's Names on Live Birth Records.

A. Until the registrant's first birthday, names may be added for unnamed registrants upon receipt of an affidavit of amendment form created by the Bureau of Vital Statistics and signed by the parents named on the record or the legal guardian of the registrant.

B. For a person aged one (1) to ten (10) years of age, names may be added for unnamed registrants upon presentation of one (1) piece of documentary evidence in accordance with Section 1104.

C. For a person older than ten (10) years of age, names may be added for unnamed registrants upon presentation of two (2) pieces of documentary evidence in accordance with Section 1104. At least one (1) of the documents must have been created within the first eighteen (18) years of life.

D. Section 1105 applies to the addition of names only for unnamed registrants. Changes to names already included on a birth record, with the exception of corrections or amendments, or adding names to an already named child, shall be accomplished in accordance with Section 1110.

1106. Date of Birth Amendments to Live Birth Records.

A. The date of live birth cannot be changed to a date that is after the date the live birth record was registered.

B. The date of live birth may be amended with a certified copy of a record from the hospital of birth and an affidavit created by the Department and signed by a party listed in Section 1103(B).

C. Other administrative amendments to the date of live birth may be made provided that an affidavit created by the Department and signed by a party listed in Section 1103.B presents a minimum of two (2) documents that adequately support that the registrant has consistently used the date from childhood and the change does not make the live birth date after the date the live birth record was registered. At least one (1) of the documents must have been created within eighteen (18) years of the alleged date of live birth. The change cannot be made if that change would conflict with any live birth record registered in the Bureau of Vital Statistics for other children of the same birth mother.

1107. Amendments to Marital Status on Death Records.

A. When the marital status is shown as married and a surviving spouse is listed on the death record of the decedent then the marital status shall be changed to:

(1) widowed and the spouse removed if a death certification for the spouse is submitted documenting that the spouse died prior to the death of the decedent.

(2) divorced or never married and the spouse removed if a certification of divorce/annulment is submitted documenting that the event occurred prior to the death of the decedent.

B. If the marital status is shown as married and surviving spouse is listed as unknown or is blank on the death record, then a marriage certification must be provided to add the name of the surviving spouse.

C. If the marital status is shown as married and the surviving spouse is listed on the death record then an order from a court of competent jurisdiction will be needed to change that spouse to a different person.

D. When the marital status is shown as divorced, widowed, or never married and no surviving spouse is listed on the death record of the decedent then the marital status shall be amended to married and the surviving spouse added upon receipt of:

(1) a certified copy of a marriage record showing that the person to be listed as surviving spouse was married to the decedent and an affidavit of correction signed by the informant and the alleged surviving spouse; or

(2) an order from a court of competent jurisdiction finding that the person was married to the decedent at the time of the decedent's death.

E. Other changes to marital status and surviving spouse will be made only upon the finding of a court of competent jurisdiction in an order that determined the marital status of the decedent and identifies the surviving spouse, if appropriate.

1108. Amendments to Also Known As (“a/k/a”) Names on Death Certificates.

Addition of a/k/a name(s) to a death certificate that were not present at the time the record was filed may be made if a document is produced that contains both names and another identifier that clearly identifies the decedent as using both names. An a/k/a for the decedent's name prior to first marriage may be made if a marriage license is provided that shows the name prior to marriage and matches the surname listed on the death certificate.

1109. Sealed Amendments and Replacement Records of Live Birth.

A. The replacement record of live birth prepared pursuant to state law shall be on the form in use at the time of its preparation and shall include the following items and such other information necessary to complete the record of live birth:

(1) the name of the child;

(2) the date, city, and county of live birth as transcribed from the original report of live birth;

(3) the names and personal information of the parents after establishment of parentage;

(4) the state file number assigned to the original record of live birth unless it has been changed through the amendment process; and

(5) the original date of registration.

B. The information necessary to locate the existing report of live birth and to complete the replacement report of live birth shall be submitted to the Department on forms prescribed or approved by the State Registrar.

C. After preparation of the replacement record of live birth, the prior record of live birth and the evidence upon which the replacement record of live birth was based shall be placed in a sealed file.

D. With the exception of an adoption of an adult, certifications of birth records of adopted children shall not be marked amended.

E. Upon receipt of notice of annulment of adoption, the original certificate of birth shall be restored to its place in the files. The adoptive certificate and evidence shall be placed in a sealed file.

F. If no certificate of birth is on file for the person for whom a replacement record is to be established under this section, a delayed certificate of birth must be filed with the Department before a new record of live birth is established. Evidence for a delayed certificate of birth shall not be required when the date and place of birth and parentage have been established in an adoption proceeding.

G. When a child is born through a gestational carrier agreement, and a pre-birth order from a court of competent jurisdiction establishing parentage was not obtained in accordance with Section 501.G, a post-birth order is acceptable when the order contains all of the following information and it matches the information that was provided to register the birth certificate:

(1) The full name and date of birth of the gestational carrier;

- (2) The date of birth and name listed on the child's birth certificate;
- (3) The hospital or place of birth;
- (4) A finding of no parental rights to the child of the gestational carrier and her spouse, if married; and
- (5) The full names (including names prior to first marriage), dates of birth, state of birth (or country, if foreign born), and any other necessary information of the intended parents to create the replacement certificate.

1110. Amendments by Court Order.

A. Upon receipt of a certified copy of a court order changing a birth or death record on file in the Bureau of Vital Statistics and upon request of an entitled person, the Bureau of Vital Statistics shall record the changes by completion of a special form developed by the Department. Such form shall include the original information as it appears on the original certificate, the information as changed by the court order, identification of the court which issued the order and the date of the order, and sufficient information about the registrant or decedent to link the special form to the original record. Upon completion of the amendment, the certified order will be maintained in a sealed file as defined in Section 1101.D.

B. When an electronic certification is issued, the items amended by the court and the date of the amendment must be noted. When a certified copy of the original record is issued, a copy of the special form must be attached.

C. Birth and death records amended by court order shall be marked "Amended by Court Order," except in parentage amendments made pursuant to S.C. Code Section 44-63-163.

D. When a parent's rights are terminated pursuant to an order from a court of competent jurisdiction, a special form is prepared by the Bureau of Vital Statistics indicating that the rights have been terminated and the certificate will not be issued to that parent after the order is received. The name of the parent will not be removed from the certificate unless it is specifically stated in the order.

1111. Administrative Amendments to Parental Titles.

A. Parental titles on a birth certificate may be designated as mother, father, or parent. Upon request of the parent listed on the certificate of a minor child, the title may be changed one (1) time for each parent upon receipt of an affidavit created by the Department and signed by the parent whose title is to be changed, stating the title the parent would prefer to be listed for their name only on the certificate.

B. Subsequent changes to the parental titles will require an order from a court of competent jurisdiction.

C. If the affidavit is completed within the first year of life, no special filing fee will be charged for creation of the affidavit and no notation will be made on the face of the certificate.

D. For certificates of adults, the affidavit must also be signed by the registrant showing consent to the parental title change.

E. Parental titles on a death certificate may be designated as mother, father, or parent. Upon request of the informant or a parent listed on the certificate, the title may be changed one (1) time for each parent upon receipt of an affidavit created by the Department and signed by the informant and the parent.

1112. Amendment of the Same Certification Item More than Once.

A. Once there has been an administrative amendment to a certification item on a vital record, except for cause and manner of death to be amended by the medical certifier or clerical error on the part of the Department, that same certification item shall not be amended again except upon receipt of an order from a court of competent jurisdiction.

B. Once an amendment by court order or parentage amendment is made to a vital record, no other amendments may be made to the same record without a subsequent order from a court of competent jurisdiction.

1200. CERTIFICATIONS FROM THE SYSTEM OF VITAL STATISTICS

A. A certification of a live birth, death, marriage, or report of divorce, or any part thereof, issued in accordance with this section, shall be considered for all purposes the same as the original and shall be prima facie evidence of the facts stated therein.

B. The applicant for a certification shall be required to submit a signed application, proof of identity, and evidence of entitlement. Upon receipt of an application and before issuing a certification:

(1) Proof of identity must be acceptable to the Bureau of Vital Statistics;

(2) Evidence of entitlement must demonstrate that the applicant is qualified to receive a certification; and

(3) The Bureau of Vital Statistics may verify with originating agencies the proof of identity documents and evidence of entitlement submitted in support of an application.

C. All certifications of vital records registered in the state system shall be issued from the state's central database.

D. For the purpose of obtaining certified copies of death records on behalf of the deceased's family at the time of registration, a funeral director or person acting as such, or the informant, shall be deemed a legal representative for up to one (1) year from the date of death.

E. No certification shall be issued without a first name for the registrant except by subpoena or to a government agency for adoption or custody purposes.

F. Information listed on live birth, death, marriage, or divorce records as administrative, statistical, medical, or health use only shall not be included in a certification of the vital record. The minimum fields of information that will be included on a birth certification are:

(1) Registrant's full name, date of birth, place of birth, and sex;

(2) The parent's names and places of birth if listed on the original certificate; and

(3) The dates of registration and issuance.

G. Each certification issued shall be certified as a true representation of the facts on file, the date issued, the state file number, and the registrar's signature or an authorized facsimile thereof. Each copy issued shall show the date of filing and copies issued from records marked "Delayed," "Amended," or "Amended by Court Order" shall be similarly marked and show the effective date.

H. Verification of the facts contained in a vital record may be furnished by the Bureau of Vital Statistics to any government agency in the conduct of its official duties. The request for verification must:

(1) include an application listing the facts of the event including, at a minimum, names and dates and be in a format prescribed or approved by the Bureau of Vital Statistics; or

(2) be submitted electronically through an automated system approved by the Bureau of Vital Statistics if the requester attests to having the certification and can provide the state file number and date of registration.

(3) Verifications are subject to the record search fee schedule in Section 1300, except in cases where the verification is needed for an active criminal investigation by a verified law enforcement agency.

I. When the State Registrar receives information that a record may have been registered, corrected, or amended through fraud or misrepresentation, he or she may withhold issuance of any certification of that record pending inquiry by appropriate authorities to determine whether fraud or misrepresentation has occurred.

(1) If upon conclusion of the inquiry no fraud or misrepresentation is found, certifications shall be issued upon the request of a qualified applicant.

(2) If upon conclusion of the inquiry there is reasonable cause to suspect fraud or misrepresentation, the Bureau of Vital Statistics shall give the person named in the record notice in writing of his or her intention to void said record or cancel the amendment. The notice shall give such person an opportunity to appear and show cause why the record should not be voided or the amendment cancelled. The notice may be served on such person or, in the case of a minor, on his or her parent or legal guardian by registered mail to his or her last known address.

(3) Unless such person or his or her parent or legal guardian shall, within thirty (30) calendar days after the date of mailing, show cause why the certificate shall not be voided or the amendment cancelled, the record shall be so voided or the amendment cancelled.

(4) The voided record or amendment and evidence shall be retained but shall not be subject to inspection or copying except upon order of a court with competent jurisdiction over the Department or by the Bureau of Vital Statistics for purposes of administering the vital statistics program.

J. When the State Registrar receives information that an application for a certification may have been submitted for purposes of fraud or misrepresentation, he or she may withhold issuance of the certification requested pending inquiry by appropriate authorities to determine whether fraud or misrepresentation has occurred.

(1) If upon conclusion of the inquiry no fraud or misrepresentation is found, certification shall be issued.

(2) If upon conclusion of the inquiry there is reasonable cause to suspect fraud or misrepresentation, the requested certification shall not be issued and the Bureau of Vital Statistics shall provide copies of the application and evidence to appropriate authorities for further investigation.

(3) The application and evidence shall be retained but shall not be subject to inspection or copying except upon order of a court with competent jurisdiction over the Department or by the Bureau of Vital Statistics for purposes of administering the vital statistics program.

K. All applications and supporting documentation submitted for the purpose of issuing certifications of vital records shall be confidential and shall not be released without acceptable authorization provided to the Department by the person listed as the applicant, except upon receipt of an order from a court of competent jurisdiction.

L. Certifications of vital records will be issued in electronic format unless the electronic format does not accurately reflect information contained in the original record as determined by the State Registrar. If the electronic format of the certification cannot be produced, a book copy will be issued when the record is requested by an entitled party.

1300. FEES

Fees generated by the following fee schedule shall be retained and expended by the Department to offset the cost of operation of the Vital Records System.

FEE SCHEDULE		
a.	*Records Search (includes one certification, if located)	\$ 12.00
b.	Additional Similar Certifications of the Same Record ordered	\$ 3.00
c.	Expedited Service (additional to other required fees)	\$ 5.00
d.	*Index Verification for Government Agencies	\$ 2.00
e.	*Special Filing Fees (additional to search fee)	
	(1) Correction of certificate by affidavit	\$ 15.00
	(2) Amended certificate (adoption, legitimation court order, paternity acknowledgment)	\$ 15.00
	(3) Delayed Registration of Birth	\$ 15.00

* Indicates a non-refundable fee

HISTORY: Amended by State Register Volume 22, Issue No. 6, Part 2, eff June 26, 1998; State Register Volume 26, Issue No. 6, Part 2, eff June 28, 2002; State Register Volume 40, Issue No. 6, Doc. No. 4580, eff June 24, 2016; SCSR 47-5 Doc. No. 5118, eff May 26, 2023.

61-20. Communicable Diseases.

(Statutory Authority: 1976 Code Section 44-1-110, 44-1-140 and 44-29-10 et seq.)

TABLE OF CONTENTS

SECTION 1.	Definitions
SECTION 2.	Disease Reporting.
SECTION 3.	The Department Shall Investigate Reported Cases.

- SECTION 4. Mitigation Measures, Isolation and Quarantine to be Observed by All Health Providers.
- SECTION 5. The Department Is to Assume Control of Quarantine, Isolation and Other Control Measures.
- SECTION 6. Authorized Health Officers May Pass Through Quarantine Lines and Access Restricted Areas.
- SECTION 7. Buildings, Places and Premises Designated as Infectious.
- SECTION 8. Public Health Notices Shall Not Be Destroyed or Removed.
- SECTION 9. Persons Forbidden Entering or Leaving Contaminated Premises.
- SECTION 10. Premises at Risk for Transmission of Contagious Diseases to be Rendered Non infectious.
- SECTION 11. Persons Affected with or Exposed to Communicable Diseases Shall Comply with Department Directives.
- SECTION 12. Official School and Child Care Exclusion List of Contagious or Communicable Diseases.
- SECTION 13. Health Laws of Cities, Towns and Counties.
- SECTION 14. Public Health Orders, Law Enforcement and Appeal Process.

SECTION 1. Definitions.

A. When capitalized, and for the purposes of this regulation:

(1) "Authorized Health Officer" means an individual designated by the Director of the South Carolina Department of Health and Environmental Control or his or her designee as an individual who may act as a health officer pursuant to these regulations.

(2) "Case" means an instance of a particular disease, injury, or other Condition.

(3) "Carrier" means a person or animal that harbors a specific Infectious Agent without discernible clinical disease or manifests symptoms and serves as a potential source of spread of the infection to others.

(4) "CDC" means the United States Centers for Disease Control and Prevention.

(5) "Communicable Disease" means an Infectious Disease that can be transmitted from one source to another.

(6) "Condition" means a disease, illness or injury; an illness or abnormality in the body that interferes with a person's usual activities or feeling of wellbeing; any illness or health condition that may be caused by chemical terrorism, bioterrorism, radiological terrorism, epidemic or pandemic disease, or novel and highly infectious agents and might pose a substantial risk of a significant number of human fatalities or incidents of permanent or long-term disability.

(7) "Contact" means an individual known to have been exposed to an infected person or animal or a contaminated environment, if the exposure is sufficient to acquire that particular disease.

(8) "Contagious Disease" means a Communicable Disease capable of spreading easily from one person to another by contact or close proximity. A Contagious Disease can be transmitted from person to person or from animal to person through many means including, but not limited to, direct contact, inhalation of airborne droplets, exchange of bodily fluids, animal or insect bites, and needles.

(9) "Department" means the South Carolina Department of Health and Environmental Control.

(10) "Director" means the Director of the South Carolina Department of Health and Environmental Control.

(11) "Event" means an occurrence of public health importance due to the possibility of substantial risk of human morbidity or mortality.

(12) "Excludable Disease" means a Communicable Disease for which an individual infected with or exposed to the disease has to be removed from an environment to prevent further transmission.

(13) "Infectious Agent" means an organism, such as a virus or bacteria, capable of producing infection or Infectious Disease.

(14) "Infectious Disease" means a disease caused by an Infectious Agent potentially transferable to individuals. An Infectious Disease may or may not be communicable. An example of a non-

communicable, but Infectious Disease is a disease caused by toxins from food poisoning or infection caused by toxins in the environment, such as tetanus.

(15) "Isolation" means the physical separation of persons or animals infected with a Communicable or Infectious Disease from others in such places and under such conditions so as to prevent or limit the direct or indirect transmission of the Infectious Agent.

(16) "Outbreak" means the occurrence of more Cases than normally expected within a specific place or group of people over a given period of time.

(17) "Post-exposure Prophylaxis" means a preventive medical treatment provided to a Contact after the exposure to a disease-causing pathogen in order to prevent the development of the disease.

(18) "Public Health Notice" means a note, card, poster, placard or the like issued by an authorized public health authority conveying information or a warning regarding a known or potential risk to the public health.

(19) "Quarantine" means the restriction of activities and movements of well persons or animals who have been exposed to a Communicable Disease for the purpose of preventing disease transmission during the incubation period should infection occur. Quarantine differs from Isolation in that Isolation applies to persons who are known to be infected with a Communicable Disease. Quarantine applies to those who have been exposed to a Communicable Disease, but who are not yet infected.

(20) "Reportable Condition" means any of the diseases, Conditions or Events identified and published in the Department's Official List of Reportable Conditions of which known or suspected Cases are required to be reported to the Department.

SECTION 2. Disease Reporting.

A. The Department shall publish in January of each year, and may amend as often during each year as needed, an Official List of Reportable Conditions for which known or suspected Cases are to be reported to the Department. All physicians and healthcare practitioners, all healthcare institutions, facilities and providers, all coroners and medical examiners, all designated reporting coordinators, and all laboratories in or out of South Carolina, shall report to the Department all known or suspected Cases of Reportable Conditions occurring in South Carolina and shall do so in accordance with the timeframes, form and manner set forth in the Official List of Reportable Conditions.

B. Failure to report known or suspected Cases to the Department in accordance with Subsection (A) above may result in criminal or civil penalties as provided by South Carolina law and at the Department's discretion. Factors to be considered by the Department when assessing penalties will include, but not be limited to:

- (1) The reason for the failure to report;
- (2) Whether the failure to report was discovered by the Department or self-reported by the reporter;
- (3) Whether the failure to report was intentional or willful;
- (4) Prior measures taken by the reporter to ensure compliance with reporting requirements, including training and the implementation of policies and procedures.

C. To encourage reporting, any person or entity required to report under Subsection (A) above that fails to do so may notify the Department of the failure without risk of criminal or civil penalties, provided all of the following criteria are met:

- (1) There is no record with the Department of the reporter having previously failed to report a known or suspected Case or Cases as required or of having previously utilized this subsection to avoid criminal or civil penalties;
- (2) The reporter has not intentionally or willfully failed to report;
- (3) The reporter makes a full disclosure to the Department of all previously unreported Cases;
- (4) The reporter agrees to make its records open to the Department for review at the Department's discretion; and
- (5) The reporter agrees to remedial measures, including training and the implementation of policies and procedures, to ensure compliance with reporting requirements going forward.

SECTION 3. The Department Shall Investigate Reported Cases.

The Department shall investigate a known or suspected Case of a Reportable Condition within the state and within the designated time frame for the Condition in accordance with CDC or Department protocols. For purposes of report verification and epidemiological investigation, the Department may conduct appropriate follow-up of reports of positive tests, Conditions, clusters of diseases, or Events. Such verification and investigation may include, but may not be limited to: confirmation of test results or reports; collection and confirmation of other information required to be reported; review of healthcare records; and interviews of patients, Contacts, physicians and other appropriate healthcare staff. If the person infected with the Condition is incompetent, incapacitated or deceased, the Department may interview the guardian, next of kin, and/or spouse.

SECTION 4. Mitigation Measures, Isolation and Quarantine to be Observed by All Health Providers.

A. The Department has responsibility and authority for specifying and directing the methods of control of Communicable and Infectious Diseases and Conditions that could threaten the public health. The Department shall adopt the methods of control applicable to any such disease or Condition necessary to prevent spread of the disease or Condition including, but not limited to, Isolation and Quarantine of individuals or animals and restriction of ingress and egress to buildings, places and premises.

B. When necessary to protect the public health, the Department will make recommendations, issue directives and/or enforce or prescribe orders regarding the suppression or prevention of the spread of Communicable or Infectious Diseases and shall adopt accepted national public health recommendations or shall make such other policies as needed to meet any emergencies or conditions not provided for by general rules for the purpose of protecting public health. National public health resources may include, but may not be limited to, American Public Health Association's "Control of Communicable Diseases Manual," American Academy of Pediatrics' "Red Book," and CDC and Food and Drug Administration (FDA) Guidelines.

C. The Department may direct or order a person or entity to publish or disseminate such public health information as the Department deems necessary to protect the public health and/or prevent the spread of Communicable and Infectious Diseases. The Department has the authority to specify the content, manner and means of the publication, including, but not limited to, requiring the posting of a Public Health Notice.

D. All persons and entities shall comply with Department directives and orders to protect the public health from the spread of Communicable and Infectious Diseases. Any person or entity who, after notice, violates a directive or order of the Department issued pursuant to this section is subject to a civil penalty not to exceed one thousand dollars a day for each violation, with every day of noncompliance considered a separate violation.

SECTION 5. The Department Is to Assume Control of Quarantine, Isolation and Other Control Measures.

In all cities, towns and counties of this state, the Department shall assume control and management of all Outbreaks of Communicable Diseases and exposures to Infectious Agents and shall see that appropriate control measures, including, but not limited to, Isolation and Quarantine, are carried out in all jurisdictions. It shall be the duty of the Department to institute proper methods and control and to coordinate securing any buildings, places and premises in a manner following Communicable Disease control practices and standards as necessary to protect the public health.

SECTION 6. Authorized Health Officers May Pass Through Quarantine Lines and Access Restricted Areas.

All Authorized Health Officers shall have the privilege and shall be allowed to pass through all Quarantine lines and access restricted areas after first identifying themselves as properly Authorized Health Officers and after presenting proper identification. The Director shall specify a method of identification that such officers must carry to verify their authority.

SECTION 7. Buildings, Places and Premises Designated as Infectious.

Whenever the Department determines that a building, place or premises may pose a risk to the public health, the Department shall cause a Public Health Notice to be placed upon the outside entrance or entrances of the building, place or premises in order to warn the public of the risk. The Public Health Notice shall be in a manner comparable to the following:

“These premises may pose a risk to the public health and may not be again occupied until order of the S.C. Department of Health and Environmental Control. This notice must not be removed under penalty of law, except by an Authorized Health Officer.”

SECTION 8. Public Health Notices Shall Not Be Destroyed or Removed.

No person or persons shall alter, deface, remove, destroy or tear down any Public Health Notice, including posters, signs, or cards, posted by the Department or its designees. The occupant or person having possession or control of any building, place or premises upon which a Quarantine or other Public Health Notice has been placed shall, within twenty-four hours after destruction or removal of such by other than the proper authorities, notify the Department of such destruction or removal. All Public Health Notices shall remain as posted by the Department until such time as the Department determines there is no longer a risk to the public health.

SECTION 9. Persons Forbidden Entering or Leaving Contaminated Premises.

After the Department has declared a building, place, or premises as contaminated by a Communicable Disease or Infectious Agent and a risk to the public health, all persons, except those designated by the Department, are prohibited from entering or leaving the building, place or premises or from removing or causing to be removed any object or material whereby such Communicable Disease or Infectious Agent may be transmitted.

SECTION 10. Premises at Risk for Transmission of Contagious Diseases to be Rendered Non-infectious.

No person shall offer for rent, sale or lease, or cause or permit anyone to occupy any building, place or premises, including, but not limited to, houses, apartments, condominiums, office buildings and warehouses, that are confirmed or suspected to be a risk for transmission of any Communicable Disease or Infectious Agent until such building, place or premises has been rendered non-infectious under the supervision of the Department.

SECTION 11. Persons Affected with or Exposed to Communicable Diseases Shall Comply with Department Directives.

Any person affected with or exposed to any Communicable Disease or Infectious Agent and who the Department determines is a threat to the public health shall strictly observe such instructions, directives and orders as are given to him or her by the Department. It shall be lawful for the Department to require any person thus affected or exposed to remain within designated premises and/or to refrain from entering designated premises or workplaces for such length of time as the Department prescribes. Those persons excluded from the workplace shall not be permitted to return to work until the workplace has implemented mitigation measures or the Department has determined there is no public health risk.

SECTION 12. Official School and Child Care Exclusion List of Contagious or Communicable Diseases.

A. The Department shall publish an Official School and Child Care Exclusion List of Contagious or Communicable Diseases for which known or suspected Cases and those exposed to certain Communicable Diseases, whether symptomatic or not, shall not be permitted to attend any private, public, parochial or church school or any childcare center or facility. This Exclusion List shall include specific conditions for duration of school or childcare exclusion as well as criteria for return, and it applies to both students and staff.

B. No superintendent, principal or teacher of any school, no provider of childcare as defined in S.C. Code Ann. Section 63-13-20, and no parent or guardian of any child or minor shall permit any child or minor having or suspected of having any of the Communicable Diseases published in this Exclusion List to attend any private, public, parochial, or church school or childcare center or facility until such time as the published conditions for return have been met.

C. No administrator, faculty member, teacher, staff member, volunteer, custodian or any other person having or suspected of having any of the Communicable Diseases published in this Exclusion List shall attend any private, public, parochial, or church school or childcare center or facility until such time as the published conditions for return have been met.

D. Any person who has been exposed to certain Communicable Diseases referenced in this Exclusion List, but who is not symptomatic, shall be excluded from the school or childcare setting and shall not be permitted to attend school or child care until the attending physician or the Department

states in writing that the person may return to school or child care and he or she meets one or more of the following criteria:

- (1) determined not to have been exposed to the Excludable Disease during the period of communicability;
- (2) proven to be immune to the disease;
- (3) determined not to be a Carrier of the disease;
- (4) has been provided appropriate Post-exposure Prophylaxis;
- (5) has exceeded the maximum incubation period of the disease from the last exposure; or
- (6) the Department concludes disease transmission has ceased and no longer presents a risk to the public.

SECTION 13. Health Laws of Cities, Towns and Counties.

Nothing contained in these regulations shall be construed to prevent any city, town or county from making such health laws as they may think necessary for the preservation of public health; provided that said laws are not inconsistent with the laws approved by the Board of Health and Environmental Control. It shall be the duty of any city, town or county proposing a health law to at once furnish the Department of Health and Environmental Control with a copy of any proposed law for the approval of the Board of Health and Environmental Control before it shall become law.

SECTION 14. Public Health Orders, Law Enforcement and Appeal Process.

A. In addition to its authority provided for by statute or as otherwise provided for by regulation, the Department may issue separate orders to enforce the provisions of this regulation for the purpose of suppressing nuisances, Communicable, Contagious and Infectious Diseases, and other dangers to the public health.

B. The Director or his or her designee may request assistance from state and local law enforcement authorities in enforcing orders issued pursuant to this regulation, who must aid and assist the Director and the Department in carrying out such orders.

C. Except as otherwise provided by law, any person to whom an order is directed under this regulation may appeal the order of the Department to any court having jurisdiction. At any hearing on appeal, the person shall be provided the opportunity to present and to cross-examine witnesses. The person appealing from such order may be represented by an attorney of his or her choosing. The person or his or her attorney shall have access to any documents relied upon by the Department in issuing the order. Any order which is appealed shall remain in full force and effect throughout the pendency of the appeal.

HISTORY: Amended by State Register Volume 26, Issue No. 6, Part 1, eff June 28, 2002; State Register Volume 40, Issue No. 6, Doc. No. 4609, eff June 24, 2016.

61–21. Sexually Transmitted Diseases.

(Statutory Authority: 1976 Code Sections 44–1–110, 44–1–140 and 44–29–10 et seq.)

A. Definitions

(1) Sexually transmitted diseases or STDs –Any of a diverse group of infections caused by biologically dissimilar pathogens and transmitted by sexual contact. Sexual transmission is the only important mode of spread of some of the infections in the group while others can also be acquired by non-sexual means. These infections include but are not limited to: syphilis, gonorrhea, granuloma inguinale, lymphogranuloma venereum, chancroid, genital herpes, chlamydia infection, nongonococcal urethritis, hepatitis B, hepatitis C, pelvic inflammatory disease, and human immunodeficiency virus infection.

(2) AIDS –Acquired Immunodeficiency Syndrome; that medical condition that meets the most recent AIDS case definition of the Centers for Disease Control (CDC).

(3) Department –The South Carolina Department of Health and Environmental Control.

(4) CDC –The Centers for Disease Control of the United States Public Health Service.

(5) HIV –Human Immunodeficiency Virus, identified as the cause of HIV infection and AIDS.

(6) HIV Test –Any diagnostic test or series of tests generally accepted by medical, laboratory or public health authorities for determining infection of an individual with HIV.

(7) HIV Infection or HIV Infected –Infected with HIV, as evidenced by a positive HIV test validated by an approved confirmatory HIV test or other test or combination of tests considered valid by the Department.

(8) Contact (referring to a person) –A person who has been exposed or has been reported to have been exposed to semen, vaginal fluids, blood, or body fluids containing blood, or other body fluids designated as infectious for HIV by the CDC or the Department.

(9) Contact (referring to a behavior) –A behavior that may result in exposure to another person's semen, vaginal fluids, blood, or body fluids containing blood, or other body fluids designated as infectious for HIV by the CDC or the Department. These behaviors include but are not limited to sexual activity, needle/drug paraphernalia sharing activities, or perinatal transmission which may result in such exposure.

(10) Expose –To present or subject another person to direct contact with semen, vaginal fluids, blood, tissue, organs or body fluids containing blood, or other body fluids designated as infectious by the Department. For purposes of determining sexual exposure to HIV, the proper use of condoms and nonoxynol-9 or other chemical agents recommended by public authorities reduces but does not eliminate the risk of exposure of a sexual partner to HIV infection. The use of bleach to clean needles and/or IV drug equipment reduces but does not eliminate the risk of exposure to a needle-sharing partner to HIV infection.

(11) Suspected STD infection or person suspected of being infected with STD –Person who has had an exposure to STD infection or has been identified as a contact to an STD infected person and whose STD status is unknown.

(12) Lay healthcare giver –Person who is not a licensed health professional and who is or soon will be providing direct hands on healthcare, which poses a significant risk of exposure that may result in HIV or Hepatitis B transmission to the lay healthcare giver from the infected person.

B. Sexually transmitted diseases declared dangerous to the public health. Sexually transmitted diseases are declared to be contagious, infectious, communicable, and dangerous to the public health. Sexually transmitted diseases include all diseases or infections spread through person-to-person sexual contact which are included in the annual Department of Health and Environmental Control List of Reportable Diseases.

C. Reporting of sexually transmitted diseases.

(1) Any physician or other health professional who diagnoses or treats a case of sexually transmitted disease, and any administrator, superintendent, manager or Infection Control Practitioner of a hospital, dispensary, health care related facility, blood bank, plasma center, or charitable or penal institution in which there is a case of sexually transmitted disease shall report to the Department the case by name, date of birth, address, county of residence, sex, race, the probable date of onset of infection and the name of the physician of record. In addition, the Department may require reporting to the health authorities of the probable risk behavior leading to infection, the probable stage of infection if appropriate and other necessary information according to the form and manner as the Department directs.

(2) Each hospital, dispensary, health care related facility, blood bank, plasma center, penal or charitable institution required to report must designate to the Department at least one person, hereinafter referred to as Reporting Coordinator, who must coordinate reporting and will be responsible for ensuring that the reporting requirements of the Department are met. Written inquiries from the Department to physicians, health professionals, Reporting Coordinators, Infection Control Practitioners, and administrators regarding reporting must be answered in writing and must be mailed to the Department within fifteen days.

(3) In addition, for purposes of reporting of HIV, a completed confidential disease report form, including the positive HIV test result, is required. For purposes of reporting cases of AIDS, a completed AIDS case report form is required. For other sexually transmitted diseases, reporting is required in the form or manner specified by the Department. All information and reports in connection with persons infected with sexually transmitted diseases shall be kept strictly confidential in accordance with state law.

D. Laboratory reporting.

Any laboratory performing tests for a sexually transmitted disease shall submit a report of all positive laboratory test results for sexually transmitted diseases to the Department in the form and manner as the Department directs. For purposes of reporting sexually transmitted diseases, the positive test result, the patient's name, the name and address of physician of record, clinic, hospital, or other health care provider submitting the specimen for testing, the date the specimen was received, and the sex and race of the patient shall be reported to the Department in the form and manner that the Department directs. When accompanying the specimen, the age or date of birth of the patient, the patient's address and county of residence must also be reported. All information and reports in connection with test results indicating sexually transmitted disease shall be kept strictly confidential in accordance with state law.

E. Use of HIV test reports, AIDS case reports, and other STD reports.

The Department may utilize the reports of HIV, AIDS and other STD cases for the following purposes: partner notification services, counseling services, referral for medical management and social services, epidemiologic surveillance, protection of the public health, control of the spread of the disease, and offering laboratory services for monitoring disease progression. To the extent resources are available, the Department may develop cooperatively with the reporting physician or other health professional a plan for providing the above services.

F. Verification of HIV test reports, AIDS case reports, other STD reports and Epidemiological Surveillance.

For purposes of report verification and epidemiological surveillance, the Department may conduct appropriate follow-up of HIV test reports, AIDS case reports, and other STD reports. Such follow-up may include, but is not limited to, confirmation of HIV or other STD test results, collection and confirmation of other information required to be reported, review of hospital and physician medical records, interviews of physician and other appropriate staff, interviews of patient, interviews of contacts who may have been exposed to HIV. If the patient is incompetent or deceased, the Department may interview the patient's physician, guardian, next of kin, spouse, or contacts, and follow the CDC or the Department protocols for conducting "No Identified Risk" (NIR) investigations.

G. Confidentiality.

(1) Records kept confidential. All information and records held by the Department or its agents shall be strictly confidential. The information must not be released or made public, upon subpoena or otherwise, except in accordance with Section 44-29-135 and these regulations. Release may be made of medical or epidemiological information to the extent necessary to notify contacts (partner notification) as provided in Section 44-29-90 and 44-29-146.

(2) Disclosure to medical personnel to protect health or life of any person.

(a) If disclosure or release of STD information is allowed to medical personnel to protect the health or life of any person pursuant to Section 44-29-135(d), that relevant portion of the person's STD record may be released to the person's physician if the physician needs to know the information in order to plan and develop a course of treatment necessary for the treatment of the person's medical condition. Whenever the Department releases confidential, identifying STD information pursuant to this subsection (2)(a), the Department will first make an attempt to obtain the consent of the patient to release the information. If consent cannot be obtained, and the release is made, the Department will make an attempt to inform the patient of what information was released and to whom.

(b) When a person who has tested positive for an STD accepts a referral from the Department to a physician and/or health professional for medical care, the Department may provide the STD information to the physician and/or health professional directly involved in the medical care of the patient if the physician and/or health professional has a need to know the information in order to plan and develop a course of treatment necessary for the patient. In the case of a pregnant patient who is referred by the Department to a physician and/or health professional for medical care, the Department may provide the STD information to the physician and/or health professional directly involved in the medical care of the pregnant patient if the physician and/or health professional has a need to know the STD information in order to plan and develop a course of treatment necessary for the pregnant female and/or her newborn(s). Whenever the Department releases confidential,

identifying STD information pursuant to this subsection (2)(b), the Department will first make an attempt to obtain the consent of the patient to release the information. If consent cannot be obtained, and the release is made, the Department will make an attempt to inform the patient of what information was released and to whom.

(c) The Department may share with health departments located in other states and which are responsible for the control of STD's all information necessary for those health departments to carry out their public health mandates.

(d) If a person infected with HIV, Hepatitis B or syphilis informs the Department, or the Department learns, that he/she has, during a period of probable infection, donated or sold blood, semen, tissue, organs or other body fluids determined to be infectious by the Department, the Department may disclose or release the name of the donor only to the entity which collected the infected blood or body product. The information may be given to the collecting entity to protect the recipient and/or the blood or body product supply. The entity which collected the blood or body product must not release to any other person the information identifying the donor provided by the Department and such information must be kept strictly confidential. Whenever the Department releases confidential, identifying STD information pursuant to this subsection (2)(d), the Department will first make an attempt to obtain the consent of the patient to release the information. If consent cannot be obtained, and the release is made, the Department will make an attempt to inform the patient of what information was released and to whom.

(3) Notification of Public Schools of minors infected with HIV. When disclosure of a minor's HIV infection is reported to a public school superintendent, school nurse, or other health professional assigned to the public school pursuant to Section 44-29-135(e), the information released must be kept strictly confidential by the school superintendent, school nurse, or other health professional assigned to the public school and should only be revealed to public school personnel who have a bona fide need to know. All persons receiving the information must keep the information strictly confidential. Violation of this regulation may result in imposition of penalties as set forth in Sections 44-1-150 and 44-29-140 South Carolina Code of Laws and other applicable penalties. The method for notification of public schools is contained in Section H.(3)(a).

(4) Notification of biological parents, foster parents, persons in loco parentis, adoptive parents or guardians, functioning in a direct supervising role, of the HIV and/or Hepatitis B infected status of minors under age sixteen, persons with intellectual disability, or mentally incompetent persons. When in the judgement of the Department or the attending physician, it is necessary to protect the health or well-being of persons listed in (a), (b), or (c) below, or persons serving in a direct supervising role to persons listed in (a), (b), or (c) below or to protect the public health, the Department or the attending physician may inform, if they function in a direct supervising role, biological parents, foster parents, persons in loco parentis, adoptive parents, or guardians of the HIV and/or Hepatitis B infected status of the following persons:

(a) IV and/or Hepatitis B infected minor under age sixteen,

(b) HIV and/or Hepatitis B infected person with intellectual disability, or

(c) HIV and/or Hepatitis B infected mentally incompetent person. Any disclosure made by the Department shall only be made when in the judgment of the Department it is necessary to protect the health or well-being of the persons listed in (a), (b), or (c) above, or persons serving in a direct supervising role to persons listed in (a), (b) or (c) above, or to protect the public health.

If the Department or the attending physician discloses the HIV and/or Hepatitis B infected status of persons listed in (a) through (c) above to any of the persons serving in a direct supervising role, counseling must also be provided. Such counseling should include education regarding modes of transmission, health care needs of the particular person, recommended precautions in handling blood and body fluids and information on available community resources. Whenever the Department releases confidential, identifying STD information pursuant to this subsection 4(a)(b)(c), the Department will first make an attempt to obtain the consent of the patient to release the information. If consent cannot be obtained, and the release is made, the Department will make an attempt to inform the patient of what information was released and to whom.

(5) Notification of lay healthcare givers of the HIV and/or Hepatitis B infected status of persons to whom they are providing health care which may result in HIV and/or Hepatitis B exposure.

(a) The Department or the attending physician may inform a lay healthcare giver who is or soon will be providing health care to an HIV or Hepatitis B infected person of the HIV and/or Hepatitis B infective status of the person to whom the lay healthcare giver is providing health care, if in the opinion of the Department or the attending physician, the nature of the contact resulting from the care:

(1) poses a significant risk of exposure that may result in HIV and/or Hepatitis B transmission to the lay healthcare giver, and

(2) if the Department or the attending physician has reason to believe that the infected person, parasite the Department or physician's encouragement, has not told or will not tell the lay healthcare giver of his HIV and/or Hepatitis B infection.

(b) Before notifying the lay healthcare giver, the Department or the attending physician must notify the HIV and/or Hepatitis B infected person that the disclosure will be made and to whom it will be made. If the disclosure is made to the lay healthcare giver the Department or attending physician must notify the HIV and/or Hepatitis B infected person of the disclosure and to whom it was made. When the information is disclosed to the lay healthcare giver, counseling must also be provided. Such counseling must include education regarding health care needs of the infected person and recommended precautions in handling blood and body fluids and the necessity for confidentiality.

(6) No access to the Department STD/HIV/AIDS Records. No institution, facility, organization, agency, other entity or person shall have access to the Department STD/HIV/AIDS Records under any circumstances other than those outlined in Section 44-29-135 or Section G of these regulations.

H. School Attendance Considerations and Notification Requirements.

(1) Attendance considerations. In general, most children with HIV infection or disease should be allowed to attend school without restrictions and without fear of spread of the virus to their classmates, teachers, or other personnel in the school environment. Infected children should be permitted to participate in all regular school activities, provided their health status allows it. Medical evaluation by the child's primary health care provider should be ongoing to evaluate changes in the child's health. As appropriate, the child's health status may be monitored periodically by the child's parent/guardian, personal physician, appropriate public health professional and/or appropriate school personnel. Evaluation of the child's potential for transmitting the virus should be made by the health care professional(s) evaluating the child's health status. Information shared during this monitoring process shall be held strictly confidential, and release of this information shall be strictly limited to those persons who have a need to know.

(2) Requirement to notify public schools. In accordance with Section 44-29-135 S.C. Code of Laws, as amended, if a minor has AIDS or is infected with HIV and is attending a public school in kindergarten through fifth grade, the superintendent of the school district and the school nurse or other health professional assigned to the school the minor attends must be notified. The information given to the district superintendent and/or the school nurse or other health professional must be kept strictly confidential and should only be revealed to school personnel who have a bona fide need to know. All persons receiving this information must keep the information strictly confidential. Violation of this regulation may result in imposition of penalties as set forth in Sections 44-1-150 and 44-29-140 South Carolina Code of Laws and other applicable penalties.

(3) Method of notification of public schools:

(a) The Department shall notify the school superintendent and school nurse or other health professional assigned to the public school of the minor's HIV infection in a confidential meeting. During this meeting, the Department will provide either in writing or verbally to the superintendent and school nurse or other health professional the following information: name, date of birth of minor, and address, if known, name of public school which minor attends, if known, and the medical status of the minor, if known.

(b) The Department shall provide to the superintendent and school nurse or other health professional current Department recommendations concerning school attendance of HIV infected minor students.

(c) The Department may make available to the superintendent the services of Department personnel and/or appropriate educational materials to assist the superintendent in providing HIV/AIDS education for staff and students.

I. Day Care.

(1) Infants, children, adolescents and adults with HIV infection/disease should be admitted to day care if their health, behavior and immune status are appropriate. The decision to admit or retain an infected person should be made on a case-by-case basis. This decision should be made by the person's physician and/or appropriate public health professional, and appropriate day care personnel. The day care personnel will evaluate and monitor the person's health in the setting and the potential threat of infecting others.

(2) The day care personnel must keep all information regarding the person's HIV status strictly confidential and such day care personnel should reveal the information only to those day care workers who have a bona fide need to know.

J. Handling of Blood and Body Fluids in Schools and Day Care Centers. Blood and body fluids should be handled in accordance with the most current Department recommendations for the handling of blood and body fluids in schools and day care centers.

K. Recalcitrant HIV infected persons.

(1) For purposes of this section, a recalcitrant person is defined as one who is infected with HIV and who either:

(a) refuses curative treatment, or

(b) if while receiving treatment continues to be infectious and engages in behavior which exposes another person or the public to HIV, or

(c) if no cure is available, refuses to receive counseling or, paraite counseling, the person continues to engage in behavior, which exposes another person or the public to HIV.

(2) For purposes of this section, counseling is defined as providing information about HIV infection, the significant threat HIV infection poses to other members of the public and methods to minimize the risk to the public.

(3) The Department must when feasible attempt to work with the recalcitrant person to modify his or her behavior before seeking isolation of the recalcitrant person. This requirement will be satisfied by the Department's fulfilling the following:

(a) Attempting on at least three occasions at various times of day, to set up an appointment for counseling or to meet the person at a designated location and provide counseling. If the person cannot be located, a generic appointment letter, without identifying any infection by name, requiring the person to report to the local health department, may be sent to the person by certified mail, return receipt requested, or may be left at the person's residence. If counseling is obtained at a place other than the local health department, verification of that counseling in the form of a statement signed by the counselor must be provided to the Department.

(b) Offering counseling and/or referring to other appropriate professional and/or agencies for support services,

(c) If the Department has been unable to locate the recalcitrant person or the person has refused counseling, the Department must mail to the person's last known address a certified letter stating the behavior modifications listed below and the recalcitrant person's obligation to follow these modifications. The letter must also state that failure to comply with these control measures may result in the issuance of a public health order and/or petition for isolation. If the recalcitrant person refuses to avail himself of counseling or referral services, the Department will have been deemed to have met its obligation to attempt to work with the recalcitrant person to modify his or her behavior.

(4) In cases of recalcitrant persons who have HIV infection, modification of behavior must include cessation of behaviors that expose other persons to HIV. The Department may issue a public health order requiring the recalcitrant person to comply with appropriate directives to protect the public health. These directives may include, but are not limited to, any or all of the following:

(a) Immediately report for counseling, social work assessment, testing, or treatment;

(b) Refrain from anal, vaginal or oral intercourse, unless partner is informed of risk of infection and consents to sexual activity;

(c) Always use condoms as recommended by public authorities during anal, vaginal or oral intercourse and exercise caution when using condoms due to possible condom failure or improper use;

(d) Do not share needles or syringes unless the needle and syringes have been properly cleaned after each person uses them;

(e) Have a skin test for tuberculosis;

(f) Notify all sexual and/or needle-sharing partners of the infection;

(g) If the exact time or general time period of initial infection is known, notify or request the Department to notify sexual and/or needle-sharing partners since the date or time period of infection;

(h) If the time of initial infection is unknown, notify or request the Department to notify sexual and/or needle-sharing partners for at least the previous three years;

(i) Do not donate or sell body parts or body fluids.

(5) If the Department has reason to believe that a recalcitrant person has failed to comply with the specified behavior modifications, has forcibly or without forewarning exposed another person to HIV infection, and should be isolated pursuant to Section 44-29-115 South Carolina Code of Laws, the Department may seek isolation of that person. Isolation may be sought after reasonable means of correcting the problem have been exhausted. In order to protect the public health and encourage persons to seek HIV testing and counseling, it may be necessary for the Department and other necessary state agencies to work with persons over time to modify recalcitrant behavior.

L. Prisons and STD/HIV infected prisoners.

(1) To the extent resources are available, the Department may provide STD/HIV counseling and testing and educational resources to prisoners upon the reasonable request of any individual prisoner or prison or jail official. When the Department is asked to conduct testing in or for prisons or jails, the Department may require pre-test and post-test counseling to accompany HIV testing conducted by the Department.

(2) If a prisoner is suffering from HIV infection, AIDS or any sexually transmitted disease for which there is no cure, the prisoner's medical condition shall not be a reason for further confinement. It is the recommendation of the Department that no prisoner be confined beyond the expiration of his/her sentence simply because he/she is infected with HIV or any other sexually transmitted disease for which there is no cure. When it is known to the prison or jail that a prisoner to be released is infected with HIV, or any other STD upon the release of the infected prisoner, the facility from which the prisoner has been released shall provide the prisoner with the telephone number and address of the local health department of the prisoner's anticipated county of residence. Prior to the release of the prisoner, the prison or jail must also provide the Department of Health and Environmental Control with the name, release date, sex, date of birth, race, and, if available, address and other locating/identifying information concerning the prisoner. The Department may then require the infected prisoner to report for counseling and/or other related services.

(3) In order to protect the public health, all prisons and jails should allow during visits of prisoners and their sexual partners to possess and use condoms recommended by public health authorities. The prison or jail is not required by these regulations to expend public monies to purchase condoms, for either prisoners or visitors.

M. Counseling and Testing of Persons Charged with Crimes Involving Needle Use or Prostitution.

Any person charged with any crime involving needle use or prostitution may be required by the Department to undergo testing for sexually transmitted diseases, including HIV, and, if infected, shall submit to treatment and counseling. Such testing may be conducted within the discretion of the Department. Counseling should always be offered before and after testing.

N. Blinded Anonymous Epidemiological Studies Conducted by the Department.

Whenever the Department determines it appropriate, the Department may conduct blinded anonymous epidemiological studies. As these tests and studies cannot be performed unless blinded and

anonymous, results of the tests cannot be divulged to any person and cannot be reported, except in an epidemiological or statistical form that would not identify any individual. These studies are designed only for research purposes to ascertain the prevalence of infection in various settings and points of time.

O. Notifying patients and/or health care providers of persons co-infected with both HIV and another reportable, communicable disease.

Periodically the Department may match its registry of HIV infected persons with its registries of persons infected with other reportable, communicable diseases, such as, but not limited to, tuberculosis or syphilis. Upon finding such matches, the Department may notify those persons at increased risk of complications from HIV co-infection with another communicable disease. The Department may, in a strictly confidential manner, release necessary information to the person and/or his health care provider to protect the health of both the HIV infected individual and the public where there is an increased risk of the communicable disease.

P. Recommendation to instruct.

It is recommended that any physician or health care professional who examines, counsels or treats a person infected with a sexually transmitted disease should instruct, or note that the infected person has been instructed, in measures for preventing the spread of such infection and of the necessity for treatment.

Q. Prescribing, compounding or selling any drugs, medicines, or other substances for the cure of any STD.

Persons other than licensed physicians are forbidden to prescribe, and persons other than licensed physicians or pharmacists are forbidden to compound or sell any drugs, medicines, or other substances for the cure of any sexually transmitted disease.

R. Issuing certificates of freedom from sexually transmitted diseases prohibited.

Physicians, health officers, and all other persons are prohibited from issuing certificates of freedom from sexually transmitted disease or infection, provided this rule shall not prevent the issuance of necessary statements of freedom from infectious diseases written in such form as required for bona fide medical purposes.

S. Sexually Transmitted Diseases other than HIV.

Where these regulations specifically refer to only HIV, they shall be applicable only to HIV/AIDS and not to other sexually transmitted diseases. Where these regulations refer to sexually transmitted diseases generally or HIV and other sexually transmitted diseases, they shall be applicable to all sexually transmitted diseases.

T. Severability.

If any provision of these regulations or the application thereof to any facility, individual or circumstance shall be held invalid, such invalidity shall not affect the provisions or application of the regulations which can be given effect, and to this end the provisions of the regulations are declared to be severable.

HISTORY: Amended by State Register Volume 15, Issue 5, eff May 24, 1991; State Register Volume 16, Issue 1, dated January 24, 1992; State Register Volume 40, Issue No. 6, Doc. No. 4612, eff June 24, 2016.

Code Commissioner's Note

Pursuant to 2011 Act No. 47, § 14(B), the Code Commissioner substituted "intellectual disability" for "mental retardation" and "person with intellectual disability" or "persons with intellectual disability" for "mentally retarded".

61-22. The Evaluation of Staff of Schools and Child Care Centers for Tuberculosis.

(Statutory Authority: 1976 Code Sections 44-29-150, 44-29-160, 44-29-170)

TABLE OF CONTENTS

- I. PURPOSE AND SCOPE.
- II. DEFINITIONS.
- III. GUIDELINES FOR SCREENING AND EVALUATION.
- IV. ADDITIONAL INFORMATION AND FORMS.

I. PURPOSE AND SCOPE.

The General Assembly, in sections 44-29-150 through 44-29-170 of the 1976 South Carolina Code of Laws, charged the South Carolina Board of Health and Environmental Control with approving guidelines for the evaluation for tuberculosis of persons working in a public or private school, kindergarten, nursery or day care center for infants and children (Registered family child care homes are exempt from the requirements of these guidelines). As more fully set forth below, as a prerequisite to employment and as a condition of continued employment, all persons to whom these guidelines apply shall be evaluated for tuberculosis and shall provide certification on a form designated by the Department that the person does not have tuberculosis in an active stage. Re-evaluation will not be required for employment in subsequent consecutive years unless otherwise indicated.

These guidelines modernize the approach to screening for tuberculosis and take into account contemporary scientific and epidemiologic principles. Under these guidelines, most school employees will need to be evaluated for tuberculosis only one time and will not be required to be screened annually absent certain factors. Non-routine screening is based on epidemiologic and clinical information and is combined with an underlying policy concerning preventive treatment of tuberculosis disease and infection. These guidelines will afford children greater protection against exposure to tuberculosis in the school, kindergarten, nursery and day care center environments.

II. DEFINITIONS.

For the purpose of these guidelines, the following definitions and clarifications shall apply:

A. "Approved TB Screening Tests" means tests for the detection of TB disease and/or latent TB infection approved by the United States Food and Drug Administration and recommended by the Centers for Disease Control and Prevention.

B. "Department" means the South Carolina Department of Health and Environmental Control.

C. "DHEC 1420" means the form designated by the Department for documenting and certifying tuberculosis evaluation, including results of Approved TB Screening Tests, disposition and preventive measures.

D. "Disposition" means the plan for continuing healthcare of a person following evaluation for tuberculosis.

E. "Employee" means any person working in a public or private school, kindergarten, nursery or day care center for infants and children, whether a new hire or currently employed, whether a direct employee or an independent contractor, and whether full-time, part-time, temporary or in any other capacity. Examples of employees to whom these guidelines apply include, but are not limited to, teachers, substitute teachers, teacher aides, student teachers, administrators, school psychologists, custodians, bus drivers, coaches, trainers, guidance counselors, school nurses and cafeteria workers, among others.

F. "Latent TB infection" means a person has become infected with the bacterium that causes TB, but does not have TB in an active stage. A person with latent TB infection does not feel sick, does not have symptoms and cannot spread TB bacteria to others.

G. "Preventive treatment" means treatment to prevent latent TB infection in an individual from developing into TB disease.

H. "Tuberculosis" or "TB" means generally a bacterial infection caused by a bacterium called *Mycobacterium tuberculosis*. The bacteria usually attack the lungs, but TB bacteria can attack any part of the body such as the kidneys, spine, and brain. TB bacteria can live in the body without making you sick. This is called "latent TB infection." For most people who breathe in TB bacteria and become infected, the body is able to fight the bacteria to stop them from growing. For others, TB bacteria become active in the body and multiply. In those instances, people will go from having latent TB infection to being sick with "TB disease" or "TB in an active stage."

I. "TB disease" or "TB in an active stage" means a person has become infected with the bacterium that causes TB and the bacterium has become active and has multiplied. People with TB disease usually have symptoms and may spread TB bacteria to others.

III. GUIDELINES FOR SCREENING AND EVALUATION.

A. Evaluation for Tuberculosis:

1. As a prerequisite to employment, and as a condition for continued employment, all employees shall be evaluated for tuberculosis by a licensed healthcare provider and shall provide written certification from a licensed physician that the person does not have TB disease.

2. Tuberculosis evaluations must be completed no more than one year prior to employment.

3. Tuberculosis evaluations shall be conducted utilizing Approved TB Screening Tests.

4. Certification of tuberculosis evaluation, including disposition and preventive treatment, shall be documented on DHEC 1420 and retained in the files of the school, kindergarten, nursery or day care center for infants and children where the person works.

B. Disposition Following Evaluation:

1. Any employee with a negative Approved TB Screening Test shall require no further routine screening except as otherwise provided in section III(B)(3) below.

2. Any employee with a positive Approved TB Screening Test or with a history of latent TB infection or TB disease shall be further evaluated by a licensed healthcare provider.

a. If the evaluation reveals no TB disease, then no exclusion and no further routine screening shall be required except as otherwise provided in section III(B)(3) below.

b. If the evaluation reveals TB disease, then the individual shall be excluded from working in any school, kindergarten, nursery or day care center for infants and children until a licensed physician certifies that the individual no longer has TB in an active stage

3. An employee in a public or private school, kindergarten, nursery or day care center for infants and children that has been evaluated for tuberculosis as required above will require no further routine screening so long as the person's employment in one or more of these work settings is continuous during consecutive years. Continuous employment in consecutive years includes, but may not be limited to, a change in employment directly from one of these work settings to another such as moving from a public school directly to a private school, moving from one school district directly to another, or moving from a day care center directly to a school. Short-term breaks in employment, such as maternity or paternity leave or traditional school year breaks, e.g., summer or winter break, shall not necessitate a new TB evaluation.

4. Nothing in these guidelines shall prevent a public or private school, kindergarten, nursery or day care center for infants and children from requiring additional tuberculosis evaluations or screenings of its employees and volunteers.

C. Documentation:

1. Every school, kindergarten, nursery or day care center for infants and children shall maintain a completed DHEC 1420 for each employee and shall make such records available for review by representatives of the Department upon request. Records may be maintained in an individual facility or in a centralized office, such as in a school district office.

2. For persons who are not employed directly by a school, kindergarten, nursery or day care center, but who work in these settings, the person's employer shall maintain a completed DHEC 1420 and shall make such records available for review upon request by representatives of the Department as well as representatives of any school, kindergarten, nursery or day care center in which the person works.

3. If an employee moves or transfers directly to another public or private school, kindergarten, nursery or day care center for infants and children such that employment in any of these work settings remains uninterrupted, no additional routine screening or evaluation for tuberculosis shall be required beyond that which is described above, provided the employee has a completed DHEC 1420, which should be transferred to the new place of employment.

4. If an employee works in more than one school, kindergarten, nursery or day care center for infants and children, each facility shall maintain a separate copy of the individual's completed DHEC 1420 unless kept in a centralized office governing all places of employment.

5. Any employee who does not have proper documentation on file that he or she is free of TB disease shall be excluded from working in any school, kindergarten, nursery or day care center for infants and children until written certification by a licensed physician is received and documented on DHEC 1420 declaring that the individual does not have tuberculosis in an active stage.

D. Non-routine Screening and Recommended Education:

1. An employee who would otherwise be exempt from routine annual screening for tuberculosis may be required to undergo non-routine screening if there is epidemiologic or clinical evidence that such employee may have been exposed to TB bacteria or become infected with TB or may have moved from having latent TB infection to TB disease. Epidemiologic and clinical evidence includes, but may not be limited to:

- a. Identification of an employee as a close contact of a person with TB disease;
- b. Occurrence of tuberculosis in any public or private school, kindergarten, nursery or day care center for infants and children; or
- c. Observation of signs or symptoms in an employee suggestive of tuberculosis.

2. The Department recommends that regular employees and volunteers of public or private schools, kindergartens, nurseries or day care centers for infants and children participate in a Public Health Education element annually. Recommended Public Health Education materials will be made available by the Department and will include disease prevention, symptoms and screening information for communicable diseases common to public or private school, kindergarten, nursery or day care center environments.

IV. ADDITIONAL INFORMATION AND FORMS.

A. Questions regarding these guidelines may be addressed to personnel of the county health departments or the regional offices of the Department of Health and Environmental Control. Questions which cannot be resolved at the local level may be referred to the Tuberculosis Control Program, Department of Health and Environmental Control, 2600 Bull Street, Columbia, S.C. 29201.

B. Employees may obtain tuberculosis evaluations and certifications from private physicians. Certification forms (DHEC 1420) are available, upon request, from the Department.

HISTORY: Amended by State Register Volume 40, Issue No. 6, Doc. No. 4616, eff June 24, 2016. Amended by State Register Volume 41, Issue No. 5, Doc. No. 4704, eff May 26, 2017.

61-23. [Repealed].

HISTORY: Former Regulation, titled Control of Anthrax, repealed by SCSR 44-6 Doc. No. 4880, eff June 26, 2020.

61-24. Licensed Midwives.

(Statutory Authority: Sections 44-1-140, 40-33-30, 44-37-40, 44-37-50, and 44-89-10 et seq., S.C. Code of Laws, 1976, as amended.)

Table of Contents:

A. Purpose and Scope; Definitions.

1. Purpose and Scope.
2. Definitions.

B. Interpretations.

1. License.
2. Issuance of License.
3. Effective date and Term of License.
4. Fees.
5. Initial License.
6. Inspections.
7. Noncompliance.
8. Exceptions to Licensing Standards.
9. Change of License.
10. Revocation of License.
11. Hearings and Appeals.

- C. Requirements for Licensure.
 - 1. Midwife Apprentice License.
 - 2. Initial Midwife License.
 - 3. Examination.
 - 4. Limitations.
 - 5. Renewal of Midwife License.
 - 6. Tuberculin Skin Test Requirements.
 - 7. Delinquency Period.
- D. Scope of Practice.
- E. Educational Requirements.
- F. Prenatal Care.
 - 1. Required Visits.
 - 2. Scheduled Visits.
 - 3. Home Visit.
 - 4. Nature of Care.
 - 5. Informed Consent.
 - 6. Parent Education.
- G. Intrapartum Care.
 - 1. Intrapartum Midwife Duties.
 - 2. Examination in Labor.
 - 3. Sanitation.
 - 4. Operation Procedures.
 - 5. Medications.
- H. Postpartum Care.
 - 1. Immediate Care.
 - 2. Subsequent Checkups.
 - 3. RhoGam Requirements.
- I. Care of the Newborn.
 - 1. Immediate Care.
 - 2. Eye Care.
 - 3. Metabolic Screening.
 - 4. Subsequent Care.
 - 5. Infant Care.
 - 6. Provision of Information.
- J. Referral to Physician.
 - 1. Recognition of Problems.
 - 2. Continuity of Care.
- K. Maternal Conditions Requiring Physician Referral or Consultation.
- L. Neonatal Conditions Requiring Physician Referral.
- M. Emergency Measures.
 - 1. Examples of Emergency Situations.
 - 2. Examples of Emergency Measures.
- N. Prohibitions in the Practice of Midwifery.
 - 1. Medications.
 - 2. Surgical Procedures.

3. Artificial Means.
 4. Induced Abortion.
- O. Record Keeping and Report Requirements.
1. Record Keeping.
 2. Registration of Birth.
 3. Reporting Requirements.
- P. Department Responsibilities.
1. Midwifery Advisory Council.
 2. Monitoring Outcomes.
- Q. General.
- A. Purpose and Scope; Definitions.
1. Purpose and Scope. The purpose of this regulation is to provide requirements for licensure, education, minimum standards of care and practice to individuals who desire to practice midwifery in the State of South Carolina.
 2. Definitions. For the purposes of these regulations the following definitions apply:
 - a. Apprentice Midwife. A person authorized by the Department to engage in a course of study, to include clinical experience under the supervision of a physician, certified nurse-midwife, certified professional midwife, or midwife licensed in the State of South Carolina, who will prepare that person to become a licensed midwife.
 - b. Apprentice Midwife License. A license issued by the Department to authorize a person desiring to become a midwife to obtain clinical experience under supervision of a physician, certified nurse-midwife, certified professional midwife, or midwife licensed in the State of South Carolina. This license is not transferable.
 - c. Certified Nurse-Midwife. A registered nurse licensed to practice in this state that has been certified by the American College of Nurse-Midwives and officially recognized by the State Board of Nursing for South Carolina.
 - d. Community Health Center. A not-for-profit organization which receives federal funding to operate a local health center.
 - e. Contact Hour. A unit of measurement to describe 50–60 minutes of an approved, organized learning experience or two hours of planned and supervised clinical practice which is designed to meet professional educational objectives.
 - f. Continuing Education. Participation in an organized learning experience under responsible sponsorship or supervised clinical practice, capable direction and qualified instruction and approved by the Department for the purpose of meeting requirements for renewal of licensure under these regulations.
 - g. Certified Professional Midwife (CPM). A professional midwifery practitioner who has met the standards for certification set by the North American Registry of Midwives (NARM).
 - h. Department. The S.C. Department of Health and Environmental Control.
 - i. Health Care Provider. A physician or nurse practitioner.
 - j. License. A document issued by the Department which authorizes an individual to practice midwifery within the scope of these regulations. The license is not transferable.
 - k. Licensee. A licensed midwife or a licensed apprentice midwife.
 - l. Midwife. A person licensed by the State of South Carolina who provides midwifery services as defined below.
 - m. Midwifery Instructor. A physician, certified nurse-midwife or licensed midwife, licensed in the State of South Carolina, who has a supervisory relationship with an apprentice midwife.
 - n. Midwifery Services. Those services provided by a person who is not a medical or nursing professional licensed by an agency of the State of South Carolina, for the purpose of giving primary assistance in the birth process either free, for trade, or for money, provided, however, that this shall not preclude any medical or nursing professional from being licensed in accordance with this

regulation. This definition shall not be interpreted to include emergency services provided by lay persons or emergency care providers under emergency conditions.

o. North American Registry of Midwives (NARM). National organization which provides and maintains an evaluative process for multiple routes of midwifery education and training, and develops and administers a standardized examination system for CPM credentialing.

p. Nurse Practitioner. A registered nurse licensed to practice in this state and registered with the S.C. State Board of Nursing. A certified nurse-midwife is accepted by the Board of Nursing as meeting these requirements.

q. Physician. A person who is licensed to practice medicine in the State of South Carolina.

r. Supervision. Coordination of learning experiences, direction, and continued evaluation of the practice of an apprentice midwife.

B. Interpretations.

1. License. It shall be unlawful to conduct midwifery services within South Carolina without possessing a valid license issued by the Department.

2. Issuance of License.

a. A license is issued pursuant to the provisions of Section 44-7-260(A) of the South Carolina Code of Laws of 1976, as amended, and the standards promulgated thereunder. The issuance of a license does not guarantee adequacy of individual care, treatment, personal safety, or the well-being of any patient.

b. A license is not assignable or transferable and is subject to revocation by the Department for failure to comply with the laws and regulations of the State of South Carolina.

c. The license must be posted in a conspicuous place visible to patients.

3. Effective Date and Term of License. A license for a midwife shall be effective for a 24-month period following the date of issue. An apprentice midwife license shall be effective for a one year period following the date of issue.

4. Fees. The license fee for each midwife license is one hundred fifty dollars (\$150) per 24-month licensing period. The annual license fee for an apprentice midwife shall be fifty dollars (\$50). The license fees shall be payable to the Department and shall be used exclusively in support of activities pursuant to this regulation. Fees are not refundable.

5. Initial License. A person who has not been continuously licensed under these or prior standards shall not provide care to patients until issued an initial license.

6. Inspections. The Department is authorized to inspect records of mothers and newborns delivered by midwives at any time.

7. Noncompliance. When noncompliance with the licensing standards exists, the licensee shall be notified by the Department of the violations and required to provide information as to how and when such an item will be corrected.

8. Exceptions to Licensing Standards. The Department may make exceptions to these standards where it is determined that the health and welfare of the community require the services of the licensee and that the exception, as granted, will have no significant impact on the safety, security or welfare of the licensee's patients.

9. Change of License. A licensee shall request to the Department by letter issuance of an amended license prior to a change in the licensee's name or address.

10. Revocation of License. The Department may refuse to issue, suspend for a definite period, or revoke a license for any of the following causes:

- a. Dereliction of any duty imposed by law;
- b. Incompetence as determined by the Department;
- c. Conviction of a felony;
- d. Practicing under a false name or alias;
- e. Violation of any of the provisions of this regulation;
- f. Obtaining any fee by fraud or misrepresentation;

g. Knowingly employing, supervising, or permitting (directly or indirectly) any person or persons not licensed as apprentice or midwife to perform any work covered by these regulations;

h. Using, causing, or promoting the use of any advertising matter, promotional literature, testimonial, or any other representation however disseminated or published, which is misleading or untruthful;

i. Representing that the service or advice of a person licensed to practice medicine or nursing will be used or made available when that is not true, or using the words, "doctor" or "nurse," or similar words, abbreviations or symbols implying involvement by the medical or nursing professions when such is not the case;

j. Permitting another to use the license; and

k. Revocation of certification by NARM or other Department approved organization(s).

11. Hearings and Appeals.

a. A Department decision involving the issuance, denial, or revocation of a license may be appealed by an affected person with standing pursuant to applicable law, including S.C. Code Title 44, Chapter 1; and Title 1, Chapter 23.

b. Any person to whom an order is issued may appeal it pursuant to applicable law, including S.C. Code Title 44, Chapter 1; and Title 1, Chapter 23.

C. Requirements for Licensure. No person may provide midwifery services or represent that s/he is a midwife without first possessing a license issued by the Department in accordance with the provisions of these regulations. Licensure as a midwife shall be by certification by NARM or other Department approved organization(s). Midwives requesting initial licensure will receive a license, provided they have evidence of certification by NARM or other Department approved organization(s) and have also met other requirements as established by the Department.

EXCEPTION: Individuals licensed by the Department prior to the publication date of this regulation will not be required to obtain certification by NARM or other Department approved organization(s). However, if a midwife is delinquent in submitting her/his license renewal application and the delinquency period exceeds 30 days the midwife must obtain certification by NARM or other similar Department approved organization(s) and also meet the requirements outlined in this section.

1. Midwife Apprentice License. Upon application, an apprentice license may be issued. An apprentice license authorizes the person to obtain the required clinical experience under supervision of a physician, certified nurse-midwife, certified professional midwife, or licensed midwife. Applications for renewal of apprentice licenses must be submitted at least 90 days prior to the expiration of the initial license. A licensed apprentice midwife may apply for renewal of an apprentice license three times before obtaining certification by NARM or other Department approved organization(s). Under extenuating circumstances, one additional renewal may be granted at the discretion of the Department on a case-by-case basis. The applicant for an apprentice midwife license must:

a. Provide written verification of apprentice/supervisor relationship from the person(s) supervising the applicant and their verified relationship(s) when the apprentice license is renewed;

b. Be enrolled in an approved course of education, or have submitted evidence of a planned course of education, subject to the approval of the Department;

c. Show evidence that s/he has had negative testing for tuberculosis or is noninfectious for the same;

d. Be able to read and write English.

2. Initial Midwife License. A licensed midwife may provide care only as allowed by these regulations. In order to apply to become a licensed midwife, a person must submit:

a. Application for a midwife license;

b. Evidence of completion of certification by NARM or other Department approved organization(s);

c. Evidence of completion of an educational program to be evaluated by NARM or other Department approved organization;

d. Evidence of completed apprenticeship and a recommendation by the supervising person (clinical experience shall be supervised by a licensed midwife, a certified nurse-midwife, a certified professional midwife, or a physician active in perinatal care) to be submitted to the certifying agency;

e. Evidence of valid Healthcare Provider cardiopulmonary resuscitation (CPR) certificate by the American Red Cross or American Heart Association and Neonatal Resuscitation Program (NRP) certificate in accordance with current NARM or other Department approved organization standards;

f. Evidence that the person has had negative testing for tuberculosis or is noninfectious for the same.

3. Examination.

a. Upon approval of the above documentation by the Department the applicant may sit for the examination, and upon successfully passing the examination, may be licensed as a midwife.

b. Applicants for licensure as a midwife who lack apprenticeship in South Carolina but who have equivalent experience from another jurisdiction may apply for a midwife license and sit for the qualifying examination after submitting evidence of experience and of all other requirements to the Department. Action will be taken on each request on an individual basis.

4. Limitations. A licensed midwife may sponsor a maximum of three apprentice midwives simultaneously.

5. Renewal of Midwife License. Licenses must be renewed every 24 months. An applicant for renewal of a midwife license must submit at least 60 days prior to the expiration of his/her license:

a. A midwife license renewal application;

b. Evidence of completion of certification by NARM or other Department approved organization(s);

c. Evidence of completion of 30 contact hours of continuing education during the licensing period;

d. Evidence of certification from the American Red Cross or American Heart Association in cardiopulmonary resuscitation of adult and newborn within the previous year;

e. Evidence of participation in an annual peer review;

f. Evidence of an annual negative skin test for tuberculosis or is noninfectious for the same.

g. EXCEPTION: Individuals licensed by the Department prior to the publication date of this regulation and not certified by NARM or other Department approved organization(s) must submit the following to the Department:

(1) Evidence of completion of 30 contact hours of continuing education during the licensing period;

(2) Evidence of valid Healthcare Provider cardiopulmonary resuscitation (CPR) certificate by the American Red Cross or American Heart Association and Neonatal Resuscitation Program (NRP) certificate in accordance with current NARM or other Department approved organization standards;

(3) Evidence of participation in an annual peer review.

6. Tuberculin Skin Test Requirements. Within three months prior to initial application and annually thereafter, midwives and apprentices shall have a tuberculin skin test, unless a previously positive reaction can be documented. The intradermal (Mantoux) method, using five tuberculin units of stabilized purified protein derivative (PPD) is to be used. Persons with tuberculin test reactions of 10mm or more of induration should be referred to a physician for appropriate evaluation. The two-step procedure (one Mantoux test followed one week later by another) is required for initial testing in order to establish a reliable baseline.

a. Persons with reactions of 10mm and over to the initial application tuberculin test, those who have previously-documented positive reactions, those with new positive reactions to the skin tests, and those with symptoms suggestive of TB (e.g., cough, weight loss, night sweats, fever, etc.), shall be given a chest X-ray to determine whether TB is present. If TB is diagnosed, the person shall be referred to a physician for appropriate treatment and contacts examined.

b. There is no need to conduct an initial or routine chest X-ray on persons with negative tuberculin tests who are asymptomatic.

c. Persons with negative tuberculin skin tests shall have an annual tuberculin skin test.

d. No person who has a positive reaction to the skin test shall have patient contact until certified non-contagious by a physician.

e. New applicants who have a history of TB shall be required to have certification by a physician that they are non-contagious prior to patient contact.

f. Applicants who are known or suspected to have TB shall be required to be evaluated by a physician and will not be allowed to have patient contact until they have been certified non-contagious by the physician.

g. Preventive treatment of personnel with new positive reactions is essential, and shall be considered for all infected applicants who have patient contact, unless specifically contraindicated. Persons who complete treatment may be exempt from further routine chest X-rays unless they have symptoms of TB. Routine annual chest X-rays of persons with positive reactions do little to prevent TB and therefore are not a substitute for preventive treatment.

h. Post exposure skin tests should be provided for tuberculin negative persons within 12 weeks after termination of contact for any suspected exposure to a documented case of TB.

7. Delinquency Period. Delinquency in renewal of licensure of 30 days after the license expiration date shall result in a delinquency fee of \$25 in addition to the licensure fees noted in Section B.4. If after that period of time application has not been received, the applicant will be required to retake the midwife examination, to include payment of the examination fee.

D. Scope of Practice. The licensed midwife may provide care to low-risk women and neonates determined by medical evaluation to be prospectively normal for pregnancy and childbirth (see Sections J., K. and L.), and may deliver only women who have completed between 37 to 42 weeks of gestation, except under emergency circumstances. Care includes:

1. Prenatal supervision and counseling;

2. Preparation for childbirth;

3. Supervision and care during labor and delivery and care of the mother and newborn in the immediate postpartum, so long as progress meets criteria generally accepted as normal.

E. Educational Requirements. The Department shall set minimum educational standards and requirements. The Department may suggest or require specific topics for continuing education based on any problem areas indicated by midwives' quarterly reports, consumer feedback, or on advances in available knowledge. The Department shall keep all applicants for licensure or renewal fully informed of requirements for attaining, demonstrating and upgrading knowledge and skills.

F. Prenatal Care.

1. Required Visits. The midwife shall, upon acceptance of a woman for care, require her to have two visits with a physician, community health center or health department. One of these visits must be in the final six weeks of pregnancy. The midwife shall make entries in the patient's record of the physician, health center, or health department visits.

2. Scheduled Visits. During pregnancy, the patient shall be seen by the midwife or other appropriate health care provider according to the following schedule: at least once every four weeks until 32 weeks gestation, once every two weeks from 32 until 36 weeks, and weekly after 36 weeks.

3. Home Visit. At least one prenatal visit shall be made to each woman's home during the last six weeks of pregnancy.

4. Nature of Care. Each prenatal visit shall include the following care:

a. Assessment of general health and obstetric status;

b. Nutritional counseling;

c. Blood pressure;

d. Gross urinalysis: dip stick for sugar and protein;

e. Weight;

- f. Gestational age assessment;
- g. Fundal height;
- h. Palpation of abdomen, Leopold's maneuvers;
- i. Auscultation of FHT after 20 weeks;
- j. Assessment of psychological status;
- k. Education as to cause, treatment, and prognosis of any symptoms, problems, or concerns;
- l. Information regarding childbirth classes and other community resources; and
- m. Hematocrit and/or hemoglobin shall be assessed at approximately three and eight months gestation.

5. **Informed Consent.** The midwife shall assure that all women under his/her care understand that s/he is a midwife licensed by this Department to perform midwifery services by virtue of approved education, clinical experience, and examination, but is not a nurse or physician, and are advised of the risks, responsibilities and alternatives for care. In consultation with the expectant parents, s/he shall, prior to the expected date of confinement, plan a strategy for backup medical care for mother and infant, and for transportation to medical facilities in case of emergency, and shall coordinate such arrangements with the backup health care providers. The midwife shall obtain a signed informed consent form to keep in his/her permanent records.

6. **Parent Education.** The midwife shall assure that natural childbirth and breastfeeding education in some form is available to all of his/her patients, and that they are aware of their rights and responsibilities as consumers of maternity care.

G. Intrapartum Care.

1. **Intrapartum Midwife Duties.** During labor, the midwife's duties are to support the natural process and the mother's own efforts, in an attitude of appropriate observation and patience, as well as alertness to the parameters of normality. These duties include, but are not limited to:

- a. Ascertaining that labor is in progress;
- b. Assessing and monitoring maternal and fetal well-being;
- c. Monitoring the progress of labor;
- d. Assisting with labor coaching;
- e. Monitoring the emotional atmosphere;
- f. Delivering the baby and placenta; and
- g. Managing any problems in accordance with the guidelines cited elsewhere in these regulations and in accord with sound obstetric and neonatal practice.

2. **Examination in Labor.** The midwife will not perform any vaginal examinations on a woman with ruptured membranes and no labor, other than an initial sterile examination to be certain there is no prolapsed cord. Once active labor is assuredly in progress, exams may be made as necessary.

3. **Sanitation.** The midwife will conduct all applicable clinical procedures and maintain all equipment used in practice in an aseptic manner.

4. **Operative Procedures.** The midwife will not perform routinely any operative procedure other than artificial rupture of membranes at the introitus and/or clamping and cutting the umbilical cord.

5. **Medications.** Drugs or medications shall be administered only after consultation with and prescription by, a physician. The midwife shall not administer any drugs or medications except:

- a. For control of postpartum hemorrhage;
- b. When administering medication in accordance with regulations governing the prevention of infant blindness;
- c. When administering RhoGam in accordance with accepted standards of professional practice.

H. Postpartum Care.

1. **Immediate Care.** The midwife must remain with the mother and infant for a minimum of two hours after the birth or until s/he is certain that both are in stabilized condition, whichever is longer.

S/he shall leave clear instructions for self-care until his/her next visit. Immediate postpartum duties include:

- a. Monitoring the physical status of mother and infant, and offering any necessary routine comfort measures;
- b. Facilitation of maternal-infant bonding and family adjustment; and
- c. Inspection of the placenta and membranes.

2. Subsequent Checkups. Within 24 to 36 hours after delivery, the midwife shall visit the mother and neonate; however, if the midwife is present for the first 20 to 24 hours after delivery, the visit at 24 to 36 hours is not considered mandatory.

3. RhoGam Requirements. Women needing RhoGam should be evaluated and treated by the midwife or a health care provider within 72 hours of delivery.

I. Care of the Newborn.

1. Immediate Care. Immediate care includes assuring that the airways are clear, Apgar scoring, maintenance of warmth, clamping and cutting of umbilical cord, eye care, establishment of feeding and physical assessment.

2. Eye Care. The midwife shall instill into each of the eyes of the newborn, within one hour of birth, a prophylactic agent such as silver nitrate or a suitable substitute.

3. Metabolic Screening. All requirements for metabolic screening shall be made clear to parents. The midwife shall notify the county health department in the county where the infant resides within three days of delivery in order for a specimen to be obtained.

4. Subsequent Care. In the days and weeks following birth, care includes monitoring jaundice, counseling for feeding, continued facilitation of the attachment and parenting process, cord care, etc.

5. Infant Care. In consultation with parents, the midwife shall encourage that the infant be seen by a health care provider within two weeks of birth.

6. Provision of Information. The midwife shall assure that the parents are fully informed as to available community resources for emergency medical care for infants, well-baby care, or other needed services.

J. Referral to Physician.

1. Recognition of Problems. The midwife must be able at all times to recognize the warning signs of abnormal or potentially abnormal conditions necessitating referral to a physician. It shall be the midwife's duty to consult with a physician whenever there are significant deviations from the normal. The midwife's training and practice must reflect a particular emphasis on thorough risk assessment.

2. Continuity of Care. When referring a patient to a physician, the midwife shall remain in consultation with the physician until the resolution of the situation. It is appropriate for the midwife to maintain care of her patient to the greatest degree possible, in accordance with the patient's wishes, remaining present through delivery if possible.

K. Maternal Conditions Requiring Physician Referral or Consultation. At any time in the maternity cycle, the midwife shall obtain medical consultation, or refer for medical care, any woman who:

1. Has a history of serious problems not discovered at the initial visit with a health care provider;
2. Develops a blood pressure of 141/89 or more, or a persistent increase of 30 systolic or 15 diastolic over her usual blood pressure;
3. Develops marked edema of face and hands;
4. Develops severe persistent headaches, epigastric pain, or visual disturbances;
5. Develops proteinuria or glycosuria;
6. Has convulsions of any kind;
7. Does not gain at least 14 pounds by 30 weeks gestation or at least four pounds per month in the last trimester, or gains more than six pounds in any two-week period;
8. Has vaginal bleeding before the onset of labor;
9. Has symptoms of kidney or urinary tract infection;
10. Has symptoms of vaginitis;

11. Has symptoms of gonorrhoea, syphilis or genital herpes;
12. Smokes more than 10 cigarettes per day and does not decrease usage;
13. Appears to abuse alcohol or drugs;
14. Does not improve nutrition within satisfactory limits;
15. Is anemic (Hematocrit under 32; Hemoglobin under 11.5);
16. Develops symptoms of diabetes;
17. Has excessive vomiting;
18. Has "morning sickness" (nausea) continuing past 24 weeks gestation;
19. Develops symptoms of pulmonary disease;
20. Has polyhydramnios or oligohydramnios;
21. Is Rh negative for periodic blood testing;
22. Has severe varicosities of the vulva or extremities;
23. Has inappropriate gestational size;
24. Has suspected multiple gestation;
25. Has suspected malpresentation;
26. Has marked decrease in or cessation of fetal movements;
27. Has rupture of membranes or other signs of labor before completion of 37 weeks gestation;
28. Is past 42 weeks gestation by estimated date of confinement and/or examination;
29. Has a fever of 100.4 for 24 hours;
30. Demonstrates serious psychiatric illness or severe psychological problems;
31. Demonstrates unresolved fearfulness regarding home birth or midwife care, or otherwise desires consultation or transfer;
32. Develops respiratory distress in labor;
33. Has ruptured membranes without onset of labor within 12 hours;
34. Has meconium-stained amniotic fluid;
35. Has more than capillary bleeding in labor prior to delivery;
36. Has persistent or recurrent fetal heart tones significantly above or below the baseline, or late or irregular decelerations which do not disappear permanently with change in maternal position, or abnormally slow return to baseline after contractions;
37. Has excessive fetal movements during labor;
38. Develops ketonuria or other signs of exhaustion;
39. Develops pathological retraction ring;
40. Does not progress in dilation, effacement or station in any two-hour period in active labor;
41. Does not show continued progress to delivery after two hours in second stage (primigravida); one hour for multigravida;
42. Has a partially separated placenta or atonic uterus;
43. Has bleeding of over three cups before or after delivery of placenta;
44. Has firm uterus with no bleeding but retained placenta more than one hour;
45. Has significant change in blood pressure, pulse over 100, or is pale, cyanotic, weak or dizzy;
46. Retains placental or membrane fragments;
47. Has laceration requiring repair;
48. Has a greater than normal lochial flow;
49. Does not void urine within six hours of birth;
50. Develops a fever greater than 100.4 on any two of the first ten days postpartum excluding the first day;

51. Develops a foul-smelling or otherwise abnormal lochial flow;
52. Develops a breast infection;
53. Has signs of serious postpartum depression; and
54. Develops any other condition about which the midwife feels concern, at the midwife's discretion.

L. Neonatal Conditions Requiring Physician Referral. The midwife shall obtain medical consultation from a physician for, or shall refer for medical care, any infant who:

1. Has an Apgar score of less than seven at five minutes;
2. Has any obvious anomaly or suspected disorder, abnormal facies, etc.;
3. Develops grunting respirations, chest retractions, or cyanosis;
4. Has cardiac irregularities;
5. Has a pale, cyanotic or gray color;
6. Develops jaundice in the first 36 hours;
7. Develops an unusual degree of jaundice at any time;
8. Has an abnormal cry;
9. Has skin lesions suggesting pathology;
10. Has eye discharge suggesting pathology;
11. Has excessive moulding of head, large cephalhematoma, excessive bruising, apparent fractures, dislocations, or other injuries;
12. Weighs less than five and one-half pounds;
13. Weighs more than nine pounds, if maternal diabetes or infant birth trauma is suspected;
14. Shows signs of hypoglycemia, hypocalcemia, or other metabolic disorders;
15. Shows signs of postmaturity;
16. Has meconium staining;
17. Has edema;
18. Does not urinate or pass meconium in first 12 hours after birth;
19. Is lethargic, weak or flaccid or does not feed well;
20. Has rectal temperature below 97 degrees F. or above 100.6 degrees F.;
21. Has full, bulging or abnormally sunken fontanel; and
22. Appears abnormal in any other respect.

M. Emergency Measures. The midwife must be able to carry out emergency measures in the absence of medical help. S/he must be trained to deal effectively with those life-threatening complications most likely to arise in the course of childbirth.

1. Examples of Emergency Situations. These are:
 - a. Respiratory or circulatory failure in mother or infant;
 - b. Postpartum hemorrhage;
 - c. Cord prolapse;
 - d. Tight nuchal cord;
 - e. Multiple births and malpresentations;
 - f. Shoulder dystocia;
 - g. Gross prematurity or intra-uterine growth retardation; and
 - h. Serious congenital anomalies.
2. Examples of Emergency Measures. These are:
 - a. Episiotomy; and
 - b. Intramuscular administration of Pitocin for the control of postpartum hemorrhage.

N. Prohibitions in the Practice of Midwifery.

1. Medications. The midwife shall not administer any drugs or injections of any kind, except as indicated in Sections G.5 and M.2.b.

2. Surgical Procedures. The midwife shall not perform any operative procedures or surgical repairs other than artificial rupture of membranes at the introitus, and clamping and cutting of the umbilical cord or as noted above in an emergency.

3. Artificial Means. The midwife shall not use any artificial, forcible or mechanical means to assist the delivery.

4. Induced Abortion. The midwife shall not perform nor participate in induced abortions.

O. Record Keeping and Report Requirements.

1. Record Keeping. The midwife shall maintain records of each mother and neonate which shall contain information as described below. All notes shall be legibly written or typed, dated and signed.

a. The mother's record shall include as a minimum:

(1) Face Sheet: Name, address (including county), telephone number, age, race, date of birth, occupation, marital status, religion, social security number, name of baby's father, midwife in attendance, apprentice midwife (if present), address and telephone number of person(s) to be contacted in the event of emergency, and name and address of physician to be contacted in the event of emergency;

(2) History of hereditary conditions in mother's and/or father's family;

(3) First day of the last menstrual period and estimated day of confinement;

(4) Blood group and Rh type;

(5) Serological test for syphilis (including dates performed);

(6) Number, duration and outcome of previous pregnancies, with dates;

(7) Drugs taken during pregnancy, labor and delivery;

(8) Duration of ruptured membranes and labor, including length of second stage;

(9) Complications of labor, e.g., hemorrhage or evidence of fetal distress;

(10) Description of placenta at delivery, including number of umbilical vessels; and

(11) Estimated amount and description of amniotic fluid.

b. The neonate's record shall include at a minimum:

(1) Name, sex, race, date of birth, place of birth, parents' names, address and telephone number, midwife in attendance, and apprentice midwife (if present).

(2) Results of measurements of fetal maturity and well-being;

(3) Apgar scores at one and five minutes of age;

(4) Description of resuscitations, if required;

(5) Detailed description of abnormalities and problems occurring from birth until transfer to a referral facility;

(6) Care of the umbilical cord;

(7) Eye care; and

(8) Counseling to the mother regarding feeding, community resources for emergency medical care, well-baby care, or other needed services, and metabolic screening.

c. Records shall be maintained for no less than 25 years. All records are subject to review by the Department.

2. Registration of Birth. The midwife shall assure that the registration of the baby's birth with the County Health Department is made within five days of birth.

3. Reporting Requirements.

a. Quarterly Reports. Each midwife shall file quarterly reports with the Department on forms provided by the Department. This report includes an Individual Data Sheet which shall be completed for each mother delivered by the midwife. This form includes such information as

delivery date, parity, antepartum, labor, newborn, and postpartum statistics, as well as conditions which required consultation by a health care provider. A Summary Sheet is also submitted as a part of the quarterly report. This sheet contains a summary of the mothers cared for during the quarter, e.g., number of undelivered women registered for care with the midwife at the beginning and end of the quarter, women transferred out during antepartum, and women delivered during the quarter.

b. Special Reports. When any of the emergency measures listed in Section M. are utilized, a special report must be filed with the quarterly report to the Department, describing in detail the emergency situation, the measure(s) taken, and the outcome.

c. Consumer Reports. The midwife shall ask all mothers to complete a Consumer Feedback Form after the delivery experience and mail to the Department. These forms, which are provided to the midwives by the Department, request the mother to furnish information regarding certain statistics about the baby, e.g., name, sex, weight, date and place of delivery, and other information such as types of care the midwife provided and whether or not the mother was satisfied with that care.

d. Reporting Mortalities. The midwife shall report any maternal or infant death on a Report of Fetal Death Form (DHEC 665) to the Department, Attn: Vital Records and Public Health Statistics, within 48 hours. This report requires information concerning the death, to include sex, weight, date and place of delivery, pregnancy history, obstetric procedures, complications of labor and/or delivery, method of delivery, congenital anomalies of the fetus, and cause of death.

P. Department Responsibilities.

1. Midwifery Advisory Council.

a. The Commissioner of DHEC shall appoint a Midwifery Advisory Council which shall meet at least annually for the purpose of reviewing and advising the Department regarding matters pertaining to the training, practices, and regulation of midwives in South Carolina. The Council shall consist of three licensed midwives, one consumer of midwife care, two certified nurse-midwives, one physician active in perinatal care, and one member-at-large. Each member shall be appointed for a three-year term of office.

b. The Council shall establish a committee for peer review to consult with midwives in questions of ethics, competency and performance, and to serve as an appeal committee when disciplinary action has been taken. The committee may recommend denying, suspending, or revoking a license, or may recommend specific educational objectives, apprenticeship or other improvement measures as necessary.

2. Monitoring Outcomes.

a. As part of the monitoring process, the Department shall evaluate consumer feedback forms issued through midwives to all consumers of midwifery care. The Department shall also issue to, collect, and evaluate quarterly forms from midwives regarding their practices.

b. The Department shall ensure that high quality services are provided by midwives and apprentice midwives in this State through compliance with the standards in these regulations.

Q. General. Conditions arising which have not been addressed in these regulations shall be managed in accordance with the best practices as determined by the Department.

HISTORY: Amended by State Register Volume 17, Issue No. 7, eff July 23, 1993; State Register Volume 37, Issue No. 6, eff June 28, 2013.

61–25. Retail Food Establishments.

(Statutory Authority: 1976 Code Sections 44–1–140(2), 44–1–150, and 44–1–180)

CONTENTS

CHAPTER 1 Purpose and Definitions

CHAPTER 2 Management and Personnel

CHAPTER 3 Food

CHAPTER 4 Equipment, Utensils, and Linens

CHAPTER 5 Water, Plumbing, and Waste

- CHAPTER 6 Physical Facilities
- CHAPTER 7 Poisonous or Toxic Materials
- CHAPTER 8 Compliance and Enforcement
- CHAPTER 9 Standards for Additional Retail Food Establishment Operations

Chapter 1 Purpose and Definitions

1-1 Title, Intent, Scope

- 1-101 Title
- 1-102 Intent
- 1-103 Scope

1-2 Definitions

- 1-201 Applicability and Terms Defined

Chapter 2 Management and Personnel

2-1 Supervision

- 2-101 Responsibility
- 2-102 Knowledge
- 2-103 Duties

2-2 Employee Health

- 2-201 Responsibilities of Permit Holder, Person in Charge, and Food Employees

2-3 Personal Cleanliness

- 2-301 Hands and Arms
- 2-302 Fingernails
- 2-303 Jewelry
- 2-304 Outer Clothing

2-4 Hygienic Practices

- 2-401 Food Contamination Prevention
- 2-402 Hair Restraints
- 2-403 Animals

2-5 Responding to Contamination Events

- 2-501 Procedures for Responding

Chapter 3 Food

3-1 Characteristics

- 3-101 Condition

3-2 Sources, Specifications, and Original Containers and Records

- 3-201 Sources
- 3-202 Specifications for Receiving
- 3-203 Original Containers and Records

3-3 Protection from Contamination after Receiving

- 3-301 Preventing Contamination by Employees
- 3-302 Preventing Food and Ingredient Contamination
- 3-303 Preventing Contamination from Ice Used as a Coolant
- 3-304 Preventing Contamination from Equipment, Utensils, and Linens
- 3-305 Preventing Contamination from the Premises
- 3-306 Preventing Contamination by Consumers
- 3-307 Preventing Contamination from Other Sources

3-4 Destruction of Organisms of Public Health Concern

- 3-401 Cooking
- 3-402 Freezing
- 3-403 Reheating
- 3-404 Other Methods

3-5 Limitation of Growth of Organisms of Public Health Concern

- 3-501 Temperature and Time Control
- 3-502 Specialized Processing Methods

3-6 Food Identity, Presentation, and On-premises Labeling

- 3-601 Accurate Representation
- 3-602 Labeling
- 3-603 Consumer Advisory

3-7 Contaminated Food

- 3-701 Disposition

3-8 Special Requirements for Highly Susceptible Populations

- 3-801 Additional Safeguards

Chapter 4 Equipment, Utensils, and Linens

4-1 Materials for Construction and Repair

- 4-101 Multiuse
- 4-102 Single-Service and Single-Use

4-2 Design and Construction

- 4-201 Durability and Strength
- 4-202 Cleanability
- 4-203 Accuracy
- 4-204 Functionality
- 4-205 Acceptability

4-3 Numbers and Capacities

- 4-301 Equipment
- 4-302 Utensils, Temperature Measuring Devices, and Testing Devices
- 4-303 Cleaning Agents and Sanitizers

4-4 Location and Installation

- 4-401 Location
- 4-402 Installation

4-5 Maintenance and Operation

- 4-501 Equipment
- 4-502 Utensils and Temperature and Pressure Measuring Devices

4-6 Cleaning of Equipment and Utensils

- 4-601 Objective
- 4-602 Frequency
- 4-603 Methods

4-7 Sanitization of Equipment and Utensils

- 4-701 Objective
- 4-702 Frequency
- 4-703 Methods

4-8 Laundering

- 4-801 Objective

4-802 Frequency

4-803 Methods

4-9 Protection of Clean Items

4-901 Drying

4-902 Lubricating and Reassembling

4-903 Storing

4-904 Preventing Contamination

Chapter 5 Water, Plumbing, and Waste

5-1 Water

5-101 Source

5-102 Quality

5-103 Quantity and Availability

5-104 Distribution, Delivery, and Retention

5-2 Plumbing System

5-201 Materials

5-202 Design, Construction, and Installation

5-203 Numbers and Capacities

5-204 Location and Placement

5-205 Operation and Maintenance

5-3 Mobile Water Tank and Mobile Food Establishment Water Tank

5-301 Materials

5-302 Design and Construction

5-303 Numbers and Capacities

5-304 Operations and Maintenance

5-4 Sewage, Other Liquid Waste, and Rainwater

5-401 Mobile Holding Tank

5-402 Retention, Drainage, and Delivery

5-403 Disposal Facility

5-5 Refuse, Recyclables, and Returnables

5-501 Facilities on the Premises

5-502 Removal

5-503 Facilities for Disposal and Recycling

Chapter 6 Physical Facilities

6-1 Materials for Construction and Repair

6-101 Indoor Areas

6-102 Outdoor Areas

6-2 Design, Construction, and Installation

6-201 Cleanability

6-202 Functionality

6-3 Numbers and Capacities

6-301 Handwashing Sinks

6-302 Toilet and Urinals

6-303 Lighting

6-304 Ventilation

6-305 Dressing Areas and Lockers

6-306 Service Sinks

6-4 Location and Placement

6-401 Handwashing Sinks

6-402 Toilet Rooms

6-403 Employee Accommodations

6-404 Distressed Merchandise

6-405 Refuse, Recyclables, and Returnables

6-5 Maintenance and Operation

6-501 Premises, Structures, Attachments, and Fixtures - Methods

Chapter 7 Poisonous or Toxic Materials

7-1 Labeling and Identification

7-101 Original Containers

7-102 Working Containers

7-2 Operational Supplies and Applications

7-201 Storage

7-202 Presence and Use

7-203 Container Prohibitions

7-204 Chemicals

7-205 Lubricants

7-206 Pesticides

7-207 Medicines

7-208 First Aid Supplies

7-209 Other Personal Care Items

7-3 Stock and Retail Sale

7-301 Storage and Display

Chapter 8 Compliance and Enforcement

8-1 Regulation Applicability

8-101 Use for Intended Purpose

8-102 Additional Requirements

8-103 Variances

8-2 Plan Submission and Approval

8-201 Operating Plans

8-203 Construction Inspection and Approval

8-3 Permit to Operate

8-301 Requirement

8-302 Application Procedure

8-303 Issuance

8-304 Conditions of Retention

8-4 Inspection and Correction of Violations

8-402 Access

8-403 Report of Findings

8-404 Imminent Health Hazard

8-405 Correction of Violations

8-5 Prevention of Foodborne Disease Transmission by Employees

8-501 Investigation and Control

8-6 Constitutional Protection

8-602 Judicial Review

8-7 Authority

8-701 Legal Authority

8-9 Remedies

Administrative

8-903 Holding, Examination, and Destruction of Food

8-904 Summary Permit Suspension

8-905 Appeals

Judicial

8-913 Civil Penalties

Chapter 9 Standards for Additional Retail Food Establishment Operations

9-1 Mobile Food

9-2 Meat/Meat Product and Fish/Fish Product Sales

9-3 Outdoor Pet Dining

9-4 Wild Mushroom Foraging

9-5 Shared Use Operations

9-6 Immediate Outdoor Cooking

9-7 Barbecue Pit and Pit-Cooking Room Construction

9-8 Temporary Food Service Establishments

9-9 Community Festivals

9-10 Special Promotions

9-11 Retail Food Establishment - South Carolina Farmers Markets, Seasonal Series and Remote Service

Chapter 1 Purpose and Definitions

1-1 TITLE, INTENT, SCOPE

1-101 Title

1-101.10 Regulation 61-25.

These provisions shall be known as Regulation 61-25, hereinafter referred to as "this Regulation."

1-102 Intent

1-102.10 Food Safety, Illness Prevention, and Honest Presentation.

The purpose of this Regulation is to safeguard public health and provide to consumers food that is safe, unadulterated, and honestly presented.

1-103 Scope

1-103.10 Statement.

This Regulation establishes definitions; sets standards for management and personnel, food operations, equipment and facilities; and provides for retail food establishment permit issuance, inspection, employment restriction, permit suspension and revocation.

1-2 DEFINITIONS

1-201 Applicability and Terms Defined.

1-201.10 Statement of Application and Listing of Terms.

(A) The following definitions shall apply in the interpretation and application of this Regulation.

(B) Terms Defined. As used in this Regulation, each of the terms listed in 1-201.10(B) shall have the meanings stated below.

(1) **Accredited Program.**

(a) **“Accredited program”** means a food protection manager certification program that has been evaluated and listed by an accrediting agency as conforming to national standards for organizations that certify individuals.

(b) **“Accredited program”** refers to the certification process and is a designation based upon an independent evaluation of factors such as the sponsor’s mission, organizational structure, staff resources revenue sources, policies, public information regarding program scope, eligibility requirements, re-certification, discipline and grievance procedures, and test development and administration.

(c) **“Accredited program”** does not refer to training functions or educational programs.

(2) **Additives.**

(a) **“Food additive”** has the meaning stated in the *Federal Food, Drug, and Cosmetic Act*, Section 201(s) and 21 CFR 170.3(e)(1).

(b) **“Color additive”** has the meaning stated in the *Federal Food, Drug, and Cosmetic Act*, Section 201(t) and 21 CFR 70.3(f).

(3) **“Adulterated”** means to make food unsafe for human consumption by any means, including, but not limited to, the addition of a foreign or inferior substance or food that has violated a critical limit.

(4) **“Approved”** means acceptable to the Department based on a determination of conformity with principles, practices, and generally recognized standards that protect public health.

(5) **“A_w”** means a symbol for water activity, which measures the free moisture in a food. It is the quotient of water vapor pressure of the substance divided by the vapor pressure of pure water at the same temperature.

(6) **“Balut”** means an embryo inside a fertile egg that has been incubated for a period sufficient for the embryo to reach a specific stage of development after which it is removed from incubation before hatching.

(7) **“Beverage”** means a liquid for drinking, including water.

(8) **“Boarding house”** means a private residence in which lodgers rent one or more rooms for extended periods of time, usually weeks, months or years. The common parts of the house are maintained, and some services, such as laundry and cleaning, may be supplied. They normally provide “bed and board” which will include some meals as well as accommodation.

(9) **“Bottled drinking water”** means water that is sealed in bottles, packages, or other containers and offered for sale for human consumption, including bottled mineral water.

(10) **“Casing”** means a tubular container for sausage products made of either natural or artificial (synthetic) material.

(11) **“Certification number”** means a unique combination of letters and numbers assigned by a shellfish control authority to a molluscan shellfish dealer according to the provisions of the National Shellfish Sanitation Program.

(12) **“CFR”** means Code of Federal Regulations. Citations in this regulation to the CFR refer sequentially to the Title, Part, and Section numbers such as 40 CFR 180.194 refers to Title 40, Part 180, Section 194.

(13) **CIP.**

(a) **“CIP”** means cleaned in place by the circulation or flowing by mechanical means through a piping system of a detergent solution, water rinse, and sanitizing solution onto or over equipment surfaces that require cleaning, such as the method used, in part, to clean and sanitize a frozen dessert machine.

(b) **“CIP”** does not include the cleaning of equipment such as band saws, slicers, or mixers that are subjected to in-place manual cleaning without the use of a CIP system.

(14) **“Commingle”** means:

(a) To combine shellstock harvested on different days or from different growing areas as identified on the tag or label, or

(b) To combine shucked shellfish from containers with different container codes or different shucking dates.

(15) **Comminuted.**

(a) **“Comminuted”** means reduced in size by methods including chopping, flaking, grinding, or mincing.

(b) **“Comminuted”** includes fish or meat products that are reduced in size and restructured or reformulated such as gefilte fish, gyros, ground beef, and sausage, and a mixture of two (2) or more types of meat that have been reduced in size and combined.

(16) **“Commissary”** means a permitted retail food establishment that is authorized by the Department to provide a servicing area for mobile food unit or mobile food pushcarts for the purposes of storage of food, supplies, and single-service articles. The commissary supports the following operations:

(a) Food preparation.

(b) Equipment and utensil washing.

(c) Disposal of sewage and solid waste.

(d) Obtainment of potable water.

(e) Provides a mobile food unit or mobile food pushcart servicing and storage area.

(17) **“Community-based farmers market”** means a market sponsored by a community or governmental organization either having been certified by the SC Department of Agriculture as a SC Certified Farmer’s Market or a farmers market that meets the definition of the Farmers Market Coalition which states, “A farmers market operates multiple times per year and is organized for the purpose of facilitating personal connections that create mutual benefits for local farmers, shoppers, and communities and implements rule or guidelines of operation that ensure that the farmers market consists principally of farms selling directly to the public products that the farms have produced.”

(18) **“Community festivals”** means events sponsored by a community group, city/county/state organization, as a community celebration, that are generally theme related, and have multiple food vendors recruited to provide food to the public for a time period not to exceed three (3) consecutive days or no more than seventy-two (72) continuous hours. Each community festival is unique and will not be held more frequently than annually, although a sponsoring organization or group might have multiple but differently themed community festivals in a year.

(19) **“Consumer”** means a person who is a member of the public, takes possession of food, is not functioning in the capacity of an operator of a retail food establishment or food processing plant, and does not offer the food for resale.

(20) **“Core violation”** See (132) “Violations.”

(21) **“Corrosion-resistant materials”** means a material that maintains acceptable surface cleanliness characteristics under prolonged influence of the food to be contacted, the normal use of cleaning compounds and sanitizing solutions, and other conditions of the use environment.

(22) **“Counter-mounted equipment”** means equipment that is not portable and is designed to be mounted off the floor on a table, counter, or shelf.

(23) **“Critical control point”** means a point or procedure in a specific food system where loss of control may result in an unacceptable health risk.

(24) **“Critical limit”** means the maximum or minimum value to which a physical, biological, or chemical parameter must be controlled at a critical control point to minimize the risk that the identified food safety hazard may occur.

(25) **“Cut leafy greens”** means fresh leafy greens whose leaves have been further cut, shredded, sliced, chopped, or torn beyond any cut made to harvest intact leaves from a plant. The term “cut leafy greens” does not apply to leaves harvested intact from a plant. The term “leafy greens” includes iceberg lettuce, romaine lettuce, leaf lettuce, butter lettuce, baby leaf lettuce (i.e., immature lettuce or leafy greens), escarole, endive, spring mix, spinach, cabbage, kale, arugula, and chard. The term “leafy greens” does not include herbs such as cilantro or parsley.

(26) **“Dealer”** means a person who is authorized by a shellfish control authority for the activities of shellstock shipper, shucker-packer, repacker, reshipper, or depuration processor of molluscan shellfish according to the provisions of the National Shellfish Sanitation Program.

(27) **“Department”** means the South Carolina Department of Health and Environmental Control or agents thereof having responsibility for enforcing these regulations.

(28) **“Disclosure”** means a written statement that clearly identifies the animal-derived foods which are, or can be ordered, raw, undercooked, or without otherwise being processed to eliminate pathogens or items that contain an ingredient that is raw, undercooked, or without otherwise being processed to eliminate pathogens.

(29) **Drinking Water.**

(a) **“Drinking water”** means water that meets criteria as specified in 40 CFR 141, *National Primary Drinking Water Regulations* and R.61–58, *State Primary Drinking Water Regulation*.

(b) **“Drinking water”** is traditionally known as “potable water.”

(c) **“Drinking water”** includes the term “water” except where the term used connotes that the water is not potable, such as “boiler water,” “mop water,” “rainwater,” “wastewater,” and “nondrinking” water.

(30) **“Dry storage area”** means a room or area designated for the storage of packaged or containerized bulk food that is not time/temperature control for safety food and dry goods such as single-service items.

(31) **Easily cleanable.**

(a) **“Easily cleanable”** means a characteristic of a surface that:

(i) Allows effective removal of soil by normal cleaning methods;

(ii) Is dependent on the material, design, construction, and installation of the surface; and

(iii) Varies with the likelihood of the surface’s role in introducing pathogenic or toxigenic agents or other contaminants into food based on the surface’s approved placement, purpose, and use.

(b) **“Easily cleanable”** includes a tiered application of the criteria that qualify the surface as easily cleanable as specified in (a) of this definition to different situations in which varying degrees of cleanability are required such as:

(i) The appropriateness of stainless steel for a food preparation surface as opposed to the lack of need for stainless steel to be used for floors or for tables used for consumer dining; or

(ii) The need for a different degree of cleanability for a utilitarian attachment or accessory in the kitchen as opposed to a decorative attachment or accessory in the consumer dining area.

(32) **“Easily movable”** means:

(a) Portable; mounted on casters, gliders, or rollers; or provided with a mechanical means to safely tilt a unit of equipment for cleaning; and

(b) Having no utility connection, a utility connection that disconnects quickly, or a flexible utility connection line of sufficient length to allow the equipment to be moved for cleaning of the equipment and adjacent area.

(33) **Egg.**

(a) **“Egg”** means the shell egg of an avian species such as chicken, duck, goose, guinea, quail, ratites or turkey.

(b) **“Egg”** does not include:

(i) A balut;

(ii) The egg of reptile species such as alligator; or

(iii) An egg product.

(34) **Egg product.**

(a) **“Egg Product”** means all, or a portion of, the contents found inside eggs separated from the shell and pasteurized in a food processing plant, with or without added ingredients, intended for human consumption, such as dried, frozen, or liquid eggs.

(b) **“Egg Product”** does not include food which contains eggs only in a relatively small proportion such as cake mixes.

(35) **“Employee”** means the permit holder, person in charge, food employee, person having supervisory or managerial duties, person on the payroll, family member, volunteer, person performing work under a contractual agreement, or any other person working in a retail food establishment.

(36) **“EPA”** means the U.S. Environmental Protection Agency.

(37) **Equipment.**

(a) **“Equipment”** means an article that is used in the operation of a retail food establishment such as a freezer, grinders, hood, ice makers, meat block, mixer, oven, reach-in refrigerators, scale, sinks, slicer, stove, table temperature measuring device for ambient air, or warewashing machine.

(b) **“Equipment”** does not include apparatuses used for handling or storing large quantities of packaged foods that are received from a supplier in a cased or overwrapped lot, such as hand trucks, forklifts, dollies, pallets, racks, and skids.

(38) **“Exclude”** means to prevent a person from working as an employee in a retail food establishment or entering a retail food establishment as an employee.

(39) **“FDA”** means the U. S. Food and Drug Administration.

(40) **Fish.**

(a) **“Fish”** means fresh or saltwater finfish, crustaceans and other forms of aquatic life (including alligator, frog, aquatic turtle, jellyfish, sea cucumber, and sea urchin and the roe of such animals) other than birds or mammals, and all mollusks, if such animal life is intended for human consumption.

(b) **“Fish”** includes an edible human food product derived in whole or in part from fish, including fish that have been processed in any manner.

(41) **“Food”** means a raw, cooked, or processed edible substance, ice, beverage, or ingredient used or intended for use or for sale in whole or in part for human consumption.

(42) **“Foodborne disease outbreak”** means the occurrence of two or more cases of a similar illness resulting from the ingestion of a common food.

(43) **“Food-contact surface”** means:

(a) A surface of equipment or a utensil with which food normally comes into contact; or

(b) A surface of equipment or a utensil from which food may drain, drip, or splash:

(i) Into a food, or

(ii) Onto a surface normally in contact with food.

(44) **“Food employee”** means an individual working with unpackaged food, food equipment or utensils, or food-contact surfaces.

(45) **Food processing plant.**

(a) **“Food processing plant”** means a commercial operation that manufactures, packages, labels, or stores food for human consumption, and provides food for sale or distribution to other business entities such as food processing plants or retail food establishments.

(b) **“Food processing plant”** does not include a retail food establishment.

(46) **Game animal.**

(a) **“Game animal”** means an animal, the products of which are food, that is not classified as livestock, sheep, swine, goat, horse, mule, or other equine in 9 CFR 301.2, *Definitions*, or as poultry or fish.

(b) **“Game animal”** includes mammals such as reindeer, elk, deer, antelope, water buffalo, bison, rabbit, squirrel, opossum, raccoon, nutria, or muskrat, and nonaquatic reptiles such as land snakes.

(c) **“Game animal”** does not include ratites.

(47) **“General use pesticide”** means a pesticide that is not classified by EPA for restricted use as specified in 40 CFR 152.175, *Pesticides Classified for Restricted Use*.

(48) **“Grade A standards”** refers to milk that meets the requirements of the United States Public Health Service/FDA *Grade A Pasteurized Milk Ordinance* with which certain fluid and dry milk and milk products comply or the requirements of the Department’s R.61–34, *Raw Milk for Human Consumption*.

(49) **“Grade decal”** means an official decal issued by the Department that is posted by the Department in a retail food establishment, or on a mobile food unit or a mobile food pushcart that is representative of the most recent inspection.

(50) **“HACCP (Hazard Analysis and Critical Control Point) plan”** means a written document that delineates the formal procedures for following the Hazard Analysis and Critical Control Point principles developed by the National Advisory Committee on Microbiological Criteria for Foods.

(51) **Handwashing sink.**

(a) **“Handwashing sink”** means a lavatory, a basin for handwashing, or a plumbing fixture specifically placed for use in personal hygiene and designed for the washing of the hands.

(b) **“Handwashing sink”** includes an automatic handwashing facility.

(52) **“Hazard”** means a biological, chemical, or physical property that may cause an unacceptable consumer health risk.

(53) **“Health practitioner”** means a physician licensed to practice medicine, or if allowed by law, a nurse practitioner, physician assistant, or similar medical professional.

(54) **“Hermetically sealed container”** means a container that is designed and intended to be secure against the entry of microorganisms and, in the case of low acid canned food, is able to maintain the commercial sterility of its contents after processing.

(55) **“Highly susceptible population”** means persons who are more likely than other people in the general population to experience foodborne disease because they are:

(a) Immunocompromised; preschool age children or older adults; and

(b) Obtaining food at a facility that provides services such as: custodial care, health care, or assisted living, such as a child or adult day care center, kidney dialysis center, hospital or nursing home, or nutritional or socialization services such as a senior center.

(56) **“Imminent health hazard”** means a significant threat or danger to health that is considered to exist when there is evidence sufficient to show that a product, practice, circumstance, or event creates a situation that requires immediate correction or cessation of operation to prevent illness or injury based on:

(a) The number of potential illnesses or injuries, and

(b) The nature, severity, and duration of the anticipated illness or injury.

(57) **“Injected”** means manipulating meat to which a solution has been introduced into its interior by processes that are referred to as “injecting,” “pump marinating,” or “stitch pumping.”

(58) **“Intact Meat”** means a cut of whole muscle(s) meat that has not undergone comminution, injection, mechanical tenderization, or reconstruction.

(59) **Juice.**

(a) **“Juice”** means the aqueous liquid expressed or extracted from one or more fruits, or vegetables, purées of the edible portions of one or more fruits or vegetables, or any concentrates of such liquid or purée.

(b) **“Juice”** does not include, for purposes of HACCP, liquids, purées, or concentrates that are not used as beverages or ingredients of beverages.

(60) **“Kitchenware”** means food preparation and storage utensils.

- (61) “**Law**” means applicable local, state, and federal statutes, regulations, and ordinances.
- (62) “**Linens**” means fabric items such as cloth hampers, cloth napkins, tablecloths, wiping cloths, and work garments including cloth gloves.
- (63) “**Low-risk food processes**” means food processes that have been determined and approved by the Department to be low risk. The Department will evaluate low-risk food processes based on food items, food handling and preparation, and foodborne illness.
- (64) **Major Food Allergen.**
- (a) “**Major food allergen**” means:
- (i) Milk, egg, fish (such as bass, flounder, cod, and including crustacean shellfish such as crab, lobster, or shrimp), tree nuts (such as almonds, pecans, or walnuts), wheat, peanuts, and soybeans; or
- (ii) A food ingredient that contains protein derived from a food, as specified in (a)(i) of this definition.
- (b) “**Major food allergen**” does not include:
- (i) Any highly refined oil derived from a food specified in (a)(i) of this definition and any ingredient derived from such highly refined oil; or
- (ii) Any ingredient that is exempt under the petition or notification process specified in the *Food Allergen Labeling and Consumer Protection Act of 2004* (Public Law 108–282).
- (65) “**Meat**” means the flesh of animals used as food including the dressed flesh of cattle, swine, sheep, goats, or other edible animals, except fish, poultry, and game animals as specified under 3–201.17(A)(3) and (4).
- (66) **Mechanically tenderized.**
- (a) “**Mechanically tenderized**” means manipulating meat with deep penetration by processes which may be referred to as “blade tenderizing,” “jaccarding,” “pinning,” “needling,” or using blades, pins, needles or any mechanical device.
- (b) “**Mechanically tenderized**” does not include processes by which solutions are injected into meat.
- (67) “**mg/L**” means milligrams per liter, which is the metric equivalent of parts per million (ppm).
- (68) “**Mobile food establishment**” means a retail food establishment that consists of a commissary and mobile food units or mobile food pushcarts.
- (69) “**Mobile food unit**” means fully enclosed mobile kitchens that prepare, cook, or serve time/temperature control for safety food as an extension of a commissary.
- (70) “**Mobile food pushcart**” means limited food service units that operate as an extension of a commissary.
- (71) “**Molluscan shellfish**” means any edible species of fresh or frozen oysters, clams, mussels, and scallops or edible portions thereof, except when the scallop product consists only of the shucked adductor muscle.
- (72) **Non-continuous cooking.**
- (a) “**Non-continuous cooking**” means the cooking of food in a retail food establishment using a process in which the initial heating of the food is intentionally halted so that it may be cooled and held for complete cooking at a later time prior to sale or service.
- (b) “**Non-continuous cooking**” does not include cooking procedures that only involve temporarily interrupting or slowing an otherwise continuous cooking process.
- (73) “**Nuisance**” for the purpose of this Regulation is a public health nuisance and means whatever is dangerous to human life or detrimental to health, including but not limited to whatever structure or premises is not sufficiently ventilated, sewerred, drained, cleaned, or lighted with respect to its intended occupancy.
- (74) **Packaged.**

- (a) **“Packaged”** means bottled, canned, cartoned, bagged, or wrapped, whether packaged in a retail food establishment or a food processing plant.
- (b) **“Packaged”** does not include wrapped or placed in a carry-out container to protect the food during service or delivery to the consumer by a food employee upon consumer request.
- (75) **“Permit”** means the document issued by the Department that authorizes a person or entity to operate a retail food establishment.
- (76) **“Permit holder”** means the entity that:
- (a) Is legally responsible for the operation of the retail food establishment such as the owner, the owner’s agent, or other person; and
- (b) Possesses a valid permit to operate a retail food establishment.
- (77) **“Person”** means an association, a corporation, individual, partnership, other legal entity, government, or governmental subdivision or agency.
- (78) **“Person in charge”** means the individual present at a retail food establishment who is responsible for the operation at the time of inspection.
- (79) **Personal care items.**
- (a) **“Personal care items”** means items or substances that may be poisonous, toxic, or a source of contamination and are used to maintain or enhance a person’s health, hygiene, or appearance.
- (b) **“Personal care items”** include items such as medicines, first aid supplies, cosmetics, and toiletries such as toothpaste and mouthwash.
- (80) **“pH”** means the symbol for the negative logarithm of the hydrogen ion concentration, which it is a measure of the degree of the acidity or alkalinity of a solution. Values between zero (0) and seven (7.0) indicate acidity and values between seven (7.0) and fourteen (14.0) indicate alkalinity. The value for pure distilled water is seven (7.0), which is considered neutral.
- (81) **“Physical facilities”** means the structure and interior surfaces of a retail food establishment including accessories such as soap and towel dispensers and attachments such as light fixtures and heating or air conditioning system vents.
- (82) **“Plumbing fixture”** means a receptacle or device that:
- (a) Is permanently or temporarily connected to the water distribution system of the premises and demands a supply of water from the system; or
- (b) Discharges used water, waste materials, or sewage directly or indirectly to the drainage system of the premises.
- (83) **“Plumbing system”** means the water supply and distribution pipes; plumbing fixtures and traps; soil, waste, and vent pipes; sanitary and storm sewers and building drains, including their respective connections, devices, and appurtenances within the premises; and water-treating equipment.
- (84) **“Poisonous or toxic materials”** means substances that are not intended for ingestion and are included in 4 categories:
- (a) Cleaners and sanitizers, which include cleaning and sanitizing agents and agents such as caustics, acids, drying agents, polishes, and other chemicals;
- (b) Pesticides, except sanitizers, which include substances such as insecticides and rodenticides;
- (c) Substances necessary for the operation and maintenance of the retail food establishment such as nonfood grade lubricants and personal care items that may be deleterious to health; and
- (d) Substances that are not necessary for the operation and maintenance of the retail food establishment and are on the premises for retail sale such as petroleum products and paints.
- (85) **“Poultry”** means:
- (a) Any domesticated bird (chickens, turkeys, ducks, geese, guineas, ratites, or squabs), whether live or dead, as defined in 9 CFR 381.1, *Poultry Products Inspection Regulations Definitions, Poultry*; and

(b) Any migratory waterfowl or game bird, pheasant, partridge, quail, grouse, or pigeon, whether live or dead, as defined in 9 CFR 362.1, *Voluntary Poultry Inspection Regulations, Definitions*.

(86) “**Premises**” means:

(a) The physical facility, its contents, its land, and any adjacent or bordering contiguous land or property under the control of the permit holder; or

(b) The physical facility, its contents, and land or property not described in (a) of this definition if its facilities, contents, or land that are under the control of the permit holder and may impact the retail food establishment personnel, facilities, or operations, and the retail food establishment is only one component of a larger operation such as a healthcare facility, hotel, motel, school, recreational camp, or prison.

(87) “**Pre-operational inspection**” means an inspection conducted by the Department to determine compliance with the regulation for the purpose of obtaining a permit.

(88) “**Primal cut**” means a basic major cut into which carcasses and sides of meat are separated such as a beef round, pork loin, lamb flank, or veal breast.

(89) **Priority violation** See (132) “Violations.”

(90) **Priority foundation violation** See (132) “Violations.”

(91) “**Private residence**” means a domestic home or dwelling in which food is prepared or served for individual and family consumption. A private residence is exempt from compliance with this regulation.

(92) “**Process authority**” means a qualified person(s) approved by the Department who have expert knowledge and adequate facilities to assess and determine safe food handling and processing requirements, including but not limited to thermal processing requirements in hermetically sealed containers, reduced oxygen packaging, shelf stable non-time/temperature control for safety foods, and cooking processes.

(93) “**Product assessment**” means a process by which a retail food establishment submits food to be tested at a lab approved by Department to determine if the food is time/temperature control for safety or non-time/temperature control for safety. A product assessment shall test intrinsic and extrinsic factors necessary to determine if the food is capable of supporting the growth or toxic formation of pathogenic microorganisms.

(94) “**Public water system**” has the meaning stated in 40 CFR 141, *National Primary Drinking Water Regulations* and R.61–58, *State Primary Drinking Water Regulation*.

(95) “**Ratite**” means a flightless bird such as an emu, ostrich, or rhea.

(96) “**Raw milk**” refers to milk that has not been pasteurized and that is approved for sale and human consumption in South Carolina under the Department’s R.61–34, *Raw Milk for Human Consumption*.

(97) **Ready-to-Eat Food.**

(a) “**Ready-to-eat food**” means food that:

(i) Is in a form that is edible without additional preparation to achieve food safety, as specified under one of the following: 3–401.11(A) or (B), 3–401.12, or 3–402.11, or as specified in 3–401.11(C); or

(ii) Is a raw or partially cooked animal food and the consumer is advised as specified in 3–401.11(D)(1) and (3); or

(iii) Is prepared in accordance with a variance that is granted as specified in 3–401.11(D)(4); and

(iv) May receive additional preparation for palatability or aesthetic, epicurean, gastronomic, or culinary purposes.

(b) “**Ready-to-eat food**” includes:

(i) Raw animal food that is cooked as specified under 3–401.11 or 3–401.12, or frozen as specified under 3–402.11;

- (ii) Raw fruits and vegetables that are washed as specified under 3–302.15;
- (iii) Fruits and vegetables that are cooked for hot holding, as specified under 3–401.13;
- (iv) All time/temperature control for safety food that is cooked to the temperature and time required for the specific food under 3–401 and cooled as specified under 3–501.14;
- (v) Plant food for which further washing, cooking, or other processing is not required for food safety and from which rinds, peels, husks, or shells, if naturally present, are removed;
- (vi) Substances derived from plants such as spices, seasonings, and sugar;
- (vii) A bakery item such as bread, cakes, pies, fillings, or icing for which further cooking is not required for food safety;
- (viii) The following products that are produced in accordance with USDA guidelines and that have received a lethality treatment for pathogens: dry, fermented sausages such as dry salami or pepperoni; salt-cured meat and poultry products such as prosciutto ham, country cured ham, and Parma ham; and dried meat and poultry products such as jerky or beef sticks; and
- (ix) Foods manufactured as specified in 21 CFR Part 113, *Thermally Processed Low-Acid Foods Packaged in Hermetically Sealed Containers*.

(98) **Reduced Oxygen Packaging.**

(a) **“Reduced oxygen packaging”** means:

(i) The reduction of the amount of oxygen in a package by removing oxygen; displacing oxygen and replacing it with another gas or combination of gases; or otherwise controlling the oxygen content to a level below that normally found in the atmosphere (approximately twenty-one (21) percent at sea level); and

(ii) A process as specified in (a)(i) of this definition that involves a food for which the hazards *Clostridium botulinum* or *Listeria monocytogenes* require control in the final packaged form.

(b) **“Reduced oxygen packaging”** includes:

(i) Vacuum packaging in which air is removed from a package of food and the package is hermetically sealed so that a vacuum remains inside the package;

(ii) Modified atmosphere packaging in which the atmosphere of a package of food is modified so that its composition is different from air but the atmosphere may change over time due to the permeability of the packaging material or the respiration of the food. Modified atmosphere packaging includes reduction in the proportion of oxygen, total replacement of oxygen, or an increase in the proportion of other gases such as carbon dioxide or nitrogen;

(iii) Controlled atmosphere packaging in which the atmosphere of a package of food is modified so that until the package is opened, its composition is different from air, and continuous control of that atmosphere is maintained, such as by using oxygen scavengers or a combination of total replacement of oxygen, nonrespiring food, and impermeable packaging material;

(iv) Cook chill packaging in which cooked food is hot filled into impermeable bags which have the air expelled and are then sealed or crimped closed. The bagged food is rapidly chilled and refrigerated at temperatures that inhibit the growth of psychrotrophic pathogens; or

(v) Sous vide packaging in which raw or partially cooked food is vacuum packaged in an impermeable bag, cooked in the bag, rapidly chilled, and refrigerated at temperatures that inhibit the growth of psychrotrophic pathogens.

(99) **“Refuse”** means solid waste not carried by water through the sewage system.

(100) **“Regulation”** refers to Regulation 61–25.

(101) **“Reminder”** means a written statement concerning the health risk of consuming animal foods raw, undercooked, or without otherwise being processed to eliminate pathogens.

(102) **“Re-service”** means the transfer of food that is unused and returned by a consumer after being served or sold and in the possession of the consumer to another person.

(103) **“Restrict”** means to limit the activities of a food employee so that there is no risk of transmitting a disease that is transmissible through food, and the food employee does not work with exposed food, clean equipment, utensils, linens, or unwrapped single-service or single-use articles.

(104) **“Restricted egg”** means any check, dirty egg, incubator reject, inedible, leaker, or loss as defined in 9 CFR 590.

(105) **“Restricted use pesticide”** means a pesticide product that contains the active ingredients specified in 40 CFR 152.175, *Pesticides Classified For Restricted Use*, and that is limited to use by or under the direct supervision of a certified applicator.

(106) **“Retail food establishment”** means an operation that prepares, processes, packages, serves, or otherwise provides food for human consumption, either on or off the premises, regardless of whether there is a charge for the food. These establishments include, but are not limited to, restaurants, delicatessens, snack bars, catering operations, ice cream parlors, school cafeterias, independent living food service operations, licensed healthcare facilities, grocery stores, retail meat markets, fish/seafood markets, retail ice merchants, shared use operations, and mobile food establishments (to include the associated commissary and mobile units).

(107) **“Risk”** means the likelihood that an adverse health effect will occur within a population as a result of a hazard in a food.

(108) **“Safe material”** means:

(a) An article manufactured from or composed of materials that may not reasonably be expected to result, directly or indirectly, in their becoming a component or otherwise affecting the characteristics of any food.

(b) An additive that is used as specified in 409 of the *Federal Food, Drug, and Cosmetic Act*; or

(c) Other materials that are not additives and that are used in conformity with applicable regulations of the Food and Drug Administration.

(109) **“Sanitization”** means the application of cumulative heat or chemicals on cleaned food-contact surfaces that, when evaluated for efficacy, is sufficient to yield a reduction of 5 logs, which is equal to a 99.999 percent reduction, of representative disease microorganisms of public health importance.

(110) **“Sealed”** means free of cracks or other openings that allow the entry or passage of moisture.

(111) **“Seasonal series”** means a regularly occurring event sponsored by a community or governmental organization for promoting local business, culture, or other local specialties.

(112) **“Service animal”** means an animal such as a guide dog, signal dog, or other animal individually trained to provide assistance to an individual with a disability as per the *Americans for Disabilities Act*. Service animal does not include emotional, comfort, or similar support animals not recognized under the Americans with Disabilities Act (ADA) regulations as service animals.

(113) **“Servicing area”** means an operating base location to which a mobile food establishment or transportation vehicle returns regularly for such things as vehicle and equipment cleaning, discharging liquid or solid wastes, refilling water tanks and ice bins, and boarding food.

(114) **“Sewage”** means liquid waste containing animal or vegetable matter in suspension or solution and may include liquids containing chemicals in solution.

(115) **“Shellfish control authority”** means a state, federal, foreign, tribal, or other government entity legally responsible for administering a program that includes certification of molluscan shellfish harvesters and dealers for interstate commerce.

(116) **“Shellstock”** means raw in-shell molluscan shellfish.

(117) **“Shiga toxin-producing *Escherichia coli*”** (STEC) means any *E. coli* capable of producing Shiga toxins (also called verocytotoxins). STEC infections can be asymptomatic or may result in a spectrum of illness ranging from mild non-bloody diarrhea, to hemorrhagic colitis (i.e., bloody diarrhea), to hemolytic uremic syndrome (HUS - a type of kidney failure). Examples of serotypes

of STEC include: *E.coli* O157:H7; NM *E.coli* O26:H11; *E.coli* O145:NM; *E.coli* O103:H2 and *E. coli* O111:NM. STEC are sometimes referred to as VTEC (*verocytotoxigenic E.coli*) or as EHEC (*Enterohemorrhagic E. coli*). EHEC are a subset of STEC which can cause hemorrhagic colitis or HUS.

(118) “**Shucked shellfish**” means molluscan shellfish that have one of both shells removed.

(119) “**Single-service articles**” means tableware, carry-out utensils, and other items such as bags, containers, placemats, stirrers, straws, toothpicks, and wrappers that are designed and constructed for one time, one person use after which they are intended for discard.

(120) **Single-use articles.**

(a) “**Single-use articles**” means utensils and bulk food containers designed and constructed to be used once and discarded.

(b) “**Single-use articles**” means food packaging and other items such as wax paper, butcher paper, plastic wrap, formed aluminum food containers, jars, plastic tubs or buckets, bread wrappers, pickle barrels, ketchup bottles, and number 10 (ten) cans which do not meet the materials, durability, strength, and cleanability specifications under 4–101.11, 4–201.11, and 4–202.11 for multiuse utensils.

(121) “**Slacking**” means the process of moderating the temperature of a food such as allowing a food to gradually increase from a temperature of -10 degrees F (-23 degrees C) to 25 degrees F (-4 degrees C) in preparation for deep-fat frying or to facilitate even heat penetration during the cooking process of previously block-frozen food such as shrimp.

(122) “**Smooth**” means:

(a) A food-contact surface having a surface free of pits and inclusions with a cleanability equal to or exceeding that of one hundred (100) grit number 3 (three) stainless steel;

(b) A non-food-contact surface of equipment having a surface equal to that of commercial grade hot-rolled steel free of visible scale; and

(c) A floor, wall, or ceiling having an even or level surface with no roughness or projections that renders it difficult to clean.

(123) “**Standard Operating Procedures (SOPs)**” means established or prescribed methods to be followed for the performance of designated operations or in designated situations as determined by the Department.

(124) “**Tableware**” means eating, drinking, and serving utensils for table use such as flatware including forks, knives, spoons; hollowware including bowls, cups, serving dishes, tumblers, and plates.

(125) “**Temperature measuring device**” means a thermometer, thermocouple, thermistor, or other device that indicates the temperature of food, air, or water.

(126) “**Temporary food establishment**” means an establishment that may be authorized by the Department to operate at a fixed location for a period of time not to exceed fourteen (14) consecutive days in connection with a fair, carnival, circus, trade show, golf, or other national sporting event and other transitory gatherings organized by the community.

(127) **Time/temperature control for safety food** (formerly “potentially hazardous food” (PHF)).

(a) “**Time/temperature control for safety food**” means a food that requires time/temperature control for safety (TCS) to limit pathogenic microorganism growth or toxin formation.

(b) “**Time/temperature control for safety food**” includes:

(i) An animal food that is raw or heat-treated; a plant food that is heat-treated or consists of raw seed sprouts, cut melons, cut leafy greens, cut tomatoes, or mixtures of cut tomatoes that are not modified in a way so that they are unable to support pathogenic microorganism growth or toxin formation, or garlic-in-oil mixtures that are not modified in a way so that they are unable to support pathogenic microorganism growth or toxin formation; and

(ii) Except as specified in (c)(iv) of this definition, a food that because of the interaction of its Aw and pH values is designated as Product Assessment Required (PA) in Table (A) or (B) of this definition:

Table A. Interaction of pH and Aw for control of spores in food heat-treated to destroy vegetative cells and subsequently packaged.

Aw values	pH: Greater than 4.6 - 5.6		
	pH: 4.6 or less	pH: Greater than 4.6 - 5.6	pH: Greater than 5.6
Less than or equal to 0.92	non-TCS Food *	non-TCS Food	non-TCS Food
Greater than 0.92 - 0.95	non-TCS Food	non-TCS Food	PA **
Greater than 0.95	non-TCS Food	PA	PA

* TCS Food means Time/Temperature Control For Safety Food

** PA means Product Assessment required

Table B. Interaction of pH and Aw for control of vegetative cells and spores in food not heat-treated or heat treated but not packaged.

Aw values	pH: Greater than 4.6 - 5.0			
	pH: Less than 4.2	pH: 4.2 - 4.6	pH: Greater than 4.6 - 5.0	pH: Greater than 5.0
Less than 0.88	non-TCS Food *	non-TCS Food	non-TCS Food	non-TCS
0.88 - 0.90	non-TCS	non-TCS	non-TCS Food	PA **
Greater than 0.90 - 0.92	non-TCS	non-TCS	PA	PA
Greater than 0.92	non-TCS	PA	PA	PA

* TCS Food means Time/Temperature Control For Safety Food

** PA means Product Assessment required

(c) **“Time/temperature control for safety food”** does not include:

(i) An air-cooled hard-boiled egg with shell intact, or an egg with shell that is not hard-boiled but has been pasteurized to destroy all viable *Salmonellae*;

(ii) A food in an unopened hermetically sealed container that is commercially processed to achieve and maintain commercial sterility under conditions of non-refrigerated storage and distribution;

(iii) A food that because of its pH or Aw value, or interaction of Aw and pH values, is designated as a non-TCS food in Table A or B of this definition;

(iv) A food that is designated TCS* and a product assessment (PA) required in Table A or B of this definition and has undergone a product assessment showing that the growth or toxin formation of pathogenic microorganisms that are reasonably likely to occur in that food is precluded due to:

(aa) Intrinsic factors including added or natural characteristics of the food such as preservatives, antimicrobials, humectants, acidulants, or nutrients;

(bb) Extrinsic factors including environmental or operational factors that affect the food such as packaging, modified atmospheric such as reduced oxygen packaging, shelf life and use, or temperature range of storage and use; or

(cc) A combination of intrinsic and extrinsic factors; or

(v) A food that does not support the growth or toxin formation of pathogenic microorganisms in accordance with one of the (c)(i) through (c)(iv) of this definition even though the food may contain a pathogenic microorganism or chemical or physical contaminant at a level sufficient to cause illness or injury.

(128) **“USDA”** means the U.S. Department of Agriculture.

(129) **“Utensil”** means a food-contact implement or container used in the storage, preparation, transportation, dispensing, sale, or service of food, such as kitchenware or tableware that is multiuse, single-service, or single-use; gloves used in contact with food; temperature-sensing probes of food temperature measuring devices; and probe-type price or identification tags used in contact with food.

(130) **“Variance”** means a written document issued by the Department that authorizes a modification or waiver of one or more requirements of this regulation if, in the opinion of the Department, a health hazard or nuisance will not result from the modification or waiver.

(131) **“Vending machine”** means a self-service device that, upon insertion of a coin, paper currency, token, card, or key, or by optional manual operation, dispenses unit servings of food in bulk or in packages without the necessity of replenishing the device between each vending operation.

(132) **Violations.**

(a) **Priority violation.**

(i) **“Priority violation”** means the violation of a provision in this Regulation whose application contributes directly to the elimination, prevention or reduction to an acceptable level, hazards associated with foodborne illness or injury and there is no other provision that more directly controls the hazard. Priority violations are denoted in this regulation by the superscript **“P”**.

(ii) **“Priority violation”** includes violations with a quantifiable measure to show control of hazards such as cooking, reheating, cooling, handwashing.

(b) **Priority Foundation violation.**

(i) **“Priority foundation violation”** means the violation of a provision in this Regulation whose application supports, facilitates or enables one or more priority violations. Priority foundation violations are denoted in this regulation by the superscript **“PF”**.

(ii) **“Priority foundation violation”** includes a violation that requires the purposeful incorporation of specific actions, equipment or procedures by industry management to attain control of risk factors that contribute to foodborne illness or injury such as personnel training, infrastructure or necessary equipment, HACCP plans, documentation or record keeping, and labeling.

(c) **Core violation.**

(i) **“Core violation”** means the violation of a provision in this Regulation that is not designated as a priority item or a priority foundation violation.

(ii) **“Core violation”** includes a violation that usually relates to general sanitation, operational controls, sanitation standard operating procedures (SSOPs), facilities or structures, equipment design, or general maintenance.

(d) **“Consecutive violation”** means a priority or priority foundation or core violation that was recorded on routine or complaint inspection(s), and is recorded on consecutive routine or complaint inspection(s). Consecutive violations are the same violation citation and similar in nature.

(133) **“Warewashing”** means the cleaning and sanitizing of food-contact surfaces of equipment and utensils.

(134) **“Whole-muscle, intact beef”** means whole muscle beef that is not injected, mechanically tenderized, reconstructed, or scored and marinated, from which beef steaks may be cut.

Chapter 2 Management and Personnel

2-1 SUPERVISION

2-101 Responsibility

2-101.11 Assignment.

(A) Except as specified in (B) of this section, the permit holder shall be the person in charge or shall designate a person in charge and shall ensure that a person in charge is present at the retail food establishment during all hours of operation. **Pf**

(B) In a retail food establishment with two or more separately permitted departments that are the legal responsibility of the same permit holder and that are located on the same premises, the permit holder may designate a single person in charge who is present on the premises during all hours of food preparation, production, and service, and who is responsible for each separately permitted retail food establishment on the premises. **Pf**

2-102 Knowledge

2-102.11 Demonstration.

Based on the risks inherent to the food operation, during inspections and upon request the person in charge shall demonstrate to the Department knowledge of foodborne disease prevention, application of the Hazard Analysis and Critical Control Point principles, and the requirements of this regulation. The person in charge shall demonstrate this knowledge by:

(A) Complying with this regulation by having no priority violations during the current inspection; **Pf**

(B) Being a certified food protection manager who has shown proficiency of required information through passing a test that is part of an accredited program; **Pf** or

(C) Responding correctly to the inspector's questions as they relate to the specific food operation. The areas of knowledge include:

(1) Describing the relationship between the prevention of foodborne disease and the personal hygiene of a food employee; **Pf**

(2) Explaining the responsibility of the person in charge for preventing the transmission of foodborne disease by a food employee who has a disease or medical condition that may cause foodborne disease; **Pf**

(3) Describing the symptoms associated with the diseases that are transmissible through food; **Pf**

(4) Explaining the significance of the relationship between maintaining the time and temperature of time/temperature control for safety food and the prevention of foodborne illness; **Pf**

(5) Explaining the hazards involved in the consumption of raw or undercooked meat, poultry, eggs, and fish; **Pf**

(6) Stating the required food temperatures and times for safe cooking of time/temperature control for safety food including meat, poultry, eggs, and fish; **Pf**

(7) Stating the required temperatures and times for the safe refrigerated storage, hot holding, cooling, and reheating of time/temperature control for safety food; **Pf**

(8) Describing the relationship between the prevention of foodborne illness and the management and control of the following:

(a) Cross contamination, **Pf**

(b) Hand contact with ready-to-eat foods, **Pf**

(c) Handwashing, **Pf** and

(d) Maintaining the retail food establishment in a clean condition and in good repair; **Pf**

(9) Describing foods identified as major food allergens and the symptoms that a major food allergen could cause in a sensitive individual who has an allergic reaction; **Pf**

(10) Explaining correct procedures for cleaning and sanitizing utensils and food-contact surfaces of equipment; **Pf**

(11) Explaining the details of how the person in charge and food employees comply with the HACCP plan if a plan is required by the law, this regulation, or an agreement between the Department and the retail food establishment. **Pf**

2-102.12 Certified Food Protection Manager Certification and Food Handler Certificate.

(A) At least one employee that has supervisory and management responsibility, the authority to direct and control food preparation and service, the ability to enforce employee health policies, and a frequent presence at the facility shall be a certified food protection manager who has shown proficiency of required information through passing a test that is part of an accredited program.

(B) At all times during operation, the person in charge shall be a certified food handler or a certified food protection manager who has shown proficiency of required information through passing a test that is part of an accredited program.

(C) This section does not apply to certain types of retail food establishments deemed by the Department to pose minimal risk of causing, or contributing to, foodborne illness based on the nature of the operation and the extent of food preparation.

2-102.20 Food Protection Manager Certification.

(A) A person in charge who demonstrates knowledge by being a food protection manager that is certified by a food protection manager certification program that is evaluated and listed by a Conference for Food Protection recognized accrediting agency as conforming to the Conference for Food Protection Standards for Accreditation of Food Protection Manager Certification Programs is deemed to comply with 2-102.11(B).

(B) A retail food establishment that has an employee that is certified by a food protection manager certification program that is evaluated and listed by a Conference for Food Protection recognized accrediting agency as conforming to the Conference for Food Protection Standards for Accreditation of Food Protection Manager Certification Programs is deemed to comply with 2-102.12.

2-103 Duties

2-103.11 Person in Charge.

The person in charge shall ensure that:

(A) Retail food establishment operations are not conducted in a private residence or in a room used as living or sleeping quarters; **Pf**

(B) Persons unnecessary to the retail food establishment operation are not allowed in the food preparation, food storage, or warewashing areas, except brief visits and tours may be authorized by the person in charge if steps are taken to ensure that food, clean equipment, utensils, linens, and unwrapped single-service and single-use articles are protected from contamination; **Pf**

(C) Employees and other persons such as delivery and maintenance persons and pesticide applicators entering the food preparation, food storage, and warewashing areas comply with this regulation; **Pf**

(D) Employees are effectively cleaning their hands by routinely monitoring the employees' handwashing; **Pf**

(E) Employees are visibly observing foods as they are received to determine that they are from approved sources, delivered at the required temperatures, protected from contamination, unadulterated, by routinely monitoring the employees' observations and periodically evaluating foods upon their receipt; **Pf**

(F) Employees are verifying that foods delivered to the retail food establishment during non-operating hours are from approved sources and are placed into appropriate storage locations such that they are maintained at the required temperatures, protected from contamination, unadulterated, and accurately presented; **Pf**

(G) Employees are properly cooking time/temperature control for safety foods, being particularly careful in cooking those foods known to cause severe foodborne illness and death, such as eggs and comminuted meats, through daily oversight of the employees' routine monitoring of the cooking temperatures using appropriate temperature measuring devices properly scaled and calibrated; **Pf**

(H) Employees are using proper methods to rapidly cool time/temperature control for safety foods through daily oversight of the employees' routine monitoring of food temperatures during cooling; **Pf**

(I) Employees are properly maintaining the temperatures of time/temperature control for safety foods during hot and cold holding through daily oversight of the employees' routine monitoring of food temperatures; **Pf**

(J) Consumers who order raw or partially cooked ready-to-eat foods of animal origin are informed by a consumer advisory that the food is not cooked sufficiently to ensure its safety; **Pf**

(K) Employees are properly sanitizing cleaned multiuse equipment and utensils before they are reused through routine monitoring of solution temperature and exposure time for hot water sanitizing and chemical concentration, pH, temperature, and exposure time for chemical sanitizing; **Pf**

(L) Consumers are notified that clean tableware is to be used when they return to self-service areas such as salad bars and buffets; **Pf**

(M) Employees are preventing cross-contamination of ready-to-eat food with bare hands by properly using suitable utensils such as deli tissue, spatulas, tongs, single-use gloves, or dispensing equipment; **Pf**

(N) Employees are properly trained in food safety as it relates to their assigned duties; **Pf**

(O) Food employees are informed of their responsibility to report to the person in charge information about their health and activities as they relate to diseases that are transmissible through food; **Pf**

(P) The retail food establishment has a written plan for the restriction, exclusion and reinstatement of food employees when they are restricted or excluded for conditions as specified in 2-201.12 **Pf**; and

(Q) Written procedures and plans, where specified by this regulation and as developed by the retail food establishment, are maintained and implemented as required. **Pf**

2-2 EMPLOYEE HEALTH

2-201 Responsibilities of Permit Holder, Person in Charge, and Food Employees

2-201.11 Responsibility and Reporting Symptoms and Diagnosis.

(A) The permit holder shall require food employees to report to the person in charge information about their health and activities as they relate to diseases that are transmissible through food. A food employee shall report the information in a manner that allows the person in charge to reduce the risk of foodborne disease transmission including providing necessary additional information such as the date of onset of symptoms and an illness or of a diagnosis without symptoms if the food employee:

(1) Has any of the following symptoms:

(a) Vomiting, **P**

(b) Diarrhea, **P**

(c) Jaundice, **P**

(d) Sore throat with fever, **P** or

(e) A lesion containing pus such as a boil or infected wound that is open or draining and is:

(i) On the hands or wrists, unless an impermeable cover such as a finger cot or stall protects the lesion and a single-use glove is worn over the impermeable cover, **P**

(ii) On exposed portions of the arms, unless the lesion is protected by an impermeable cover, **P** or

(iii) On other parts of the body, unless the lesion is covered by a dry, durable, tight-fitting bandage; **P**

(2) Has an illness diagnosed by a health practitioner due to:

(a) Norovirus, **P**

(b) Hepatitis A virus, **P**

(c) *Shigella* spp., **P**

(d) Shiga toxin-producing *Escherichia coli*, **P**

(e) Typhoid fever (caused by *Salmonella* Typhi) **P** or

(f) *Salmonella* (nontyphoidal); **P**

(3) Had Typhoid fever diagnosed by a health practitioner within the past three (3) months without having received antibiotic therapy as determined by a health practitioner; **P**

(4) Has been exposed to or is the suspected source of a confirmed disease outbreak, because the food employee consumed or prepared food implicated in the outbreak or consumed food at an event prepared by a person who is infected or ill with:

(a) Norovirus within the past forty-eight (48) hours of the last exposure, **P**

(b) Shiga toxin-producing *Escherichiacoli* or *Shigella* spp. within the past three (3) days of the last exposure, **P**

(c) Typhoid fever within the past fourteen (14) days of the last exposure, **P** or

(d) Hepatitis A virus within the past thirty (30) days of the last exposure; **P** or

(5) Has been exposed by attending or working in a setting where there is a confirmed disease outbreak, or living in the same household as, and having knowledge about, an individual who works or attends a setting where there is a confirmed disease outbreak, or living in the same household as, and having knowledge about, an individual diagnosed with an illness caused by:

(a) Norovirus within the past forty-eight (48) hours of the last exposure, **P**

(b) Shiga toxin-producing *Escherichia coli* or *Shigella* spp. within the past three (3) days of the last exposure, **P**

(c) Typhoid fever (caused by *Salmonella* Typhi) within the past fourteen (14) days of the last exposure, **P** or

(d) Hepatitis A virus within the past thirty (30) days of the last exposure. **P**

(B) The person in charge shall notify the Department when a food employee is:

(1) Jaundiced, **Pf** or

(2) Diagnosed with an illness due to a pathogen as specified under (A)(2)(a) through (f) of this section. **Pf**

(C) The person in charge shall ensure that a food employee who exhibits or reports a symptom, or who reports a diagnosed illness or a history of exposure as specified under (A)(1) through (5) of this section, is:

(1) Excluded as specified under section 2–201.12 (A) -(C), and (D)(1), (E)(1), (F)(1), (G) or (H)(1) and in compliance with the provisions specified under section 2–201.13(A)through (H); **P** or

(2) Restricted as specified under 2–201.12 (D)(2), (E)(2), (F)(2), (H)(2), or section 2–201.12(I) or (J) and in compliance with the provisions specified under section 2–201.13(D)through (J). **P**

(D) A food employee shall report to the person in charge the information as specified under (A) of this section. **Pf**

(E) A food employee shall:

(1) Comply with an exclusion as specified under section 2–201.12(A) through(C) and 2–201.12(D)(1), (E)(1), (F)(1), (G), or (H)(1) and with the provisions specified under section 2–201.13(A)through (H); **P** or

(2) Comply with a restriction as specified under 2–201.12(D)(2), (E)(2), (F)(2), (G), (H)(2), or section 2–201.12 (H), (I), or (J) and comply with the provisions specified under section 2–201.13(D) through (J). **P**

2–201.12 Exclusions and Restrictions.

The person in charge shall exclude or restrict a food employee from a retail food establishment in accordance with the following:

(A) Except when the symptom is from a noninfectious condition, exclude a food employee if the food employee is:

(1) Symptomatic with vomiting or diarrhea; **P** or

(2) Symptomatic with vomiting or diarrhea and diagnosed with an infection from Norovirus, *Shigella* spp., *Salmonella* (nontyphoidal), or Shiga toxin-producing *E.coli*. **P**

(B) Exclude a food employee who is:

(1) Jaundiced and the onset of jaundice occurred within the last seven (7) calendar days, unless the food employee provides to the person in charge written medical documentation from a health practitioner specifying that the jaundice is not caused by Hepatitis A virus or other fecal-orally transmitted infection; **P**

(2) Diagnosed with an infection from Hepatitis A virus within fourteen (14) calendar days from the onset of any illness symptoms, or within 7 calendar days of the onset of jaundice; **P** or

(3) Diagnosed with an infection from Hepatitis A virus without developing symptoms. **P**

(C) Exclude a food employee who is diagnosed with Typhoid fever, or reports having had Typhoid fever within the past three (3) months as specified under 2–201.11(A)(3). **P**

(D) If a food employee is diagnosed with an infection from Norovirus and is asymptomatic:

(1) Exclude the food employee who works in a retail food establishment serving a highly susceptible population; **P**or

(2) Restrict the food employee who works in a retail food establishment not serving a highly susceptible population. **P**

(E) If a food employee is diagnosed with an infection from *Shigella* spp. and is asymptomatic:

(1) Exclude the food employee who works in a retail food establishment serving a highly susceptible population; **P** or

(2) Restrict the food employee who works in a retail food establishment not serving a highly susceptible population. **P**

(F) If a food employee is diagnosed with an infection from Shiga toxin-producing *E. coli* and is asymptomatic:

(1) Exclude the food employee who works in a retail food establishment serving a highly susceptible population; **P**or

(2) Restrict the food employee who works in a retail food establishment not serving a highly susceptible population. **P**

(G) If a food employee is diagnosed with an infection from *Salmonella* (nontyphoidal) and is asymptomatic, restrict the food employee who works in a retail food establishment serving a highly susceptible population or in a retail food establishment not serving a highly susceptible population. **P**

(H) If a food employee is ill with symptoms of acute onset of sore throat with fever:

(1) Exclude the food employee who works in a retail food establishment serving a highly susceptible population; **P**or

(2) Restrict the food employee who works in a retail food establishment not serving a highly susceptible population. **P**

(I) If a food employee is infected with a skin lesion containing pus such as a boil or infected wound that is open or draining and not properly covered as specified under 2–201.11(A)(1)(e), restrict the food employee. **P**

(J) If a food employee is exposed to a foodborne pathogen as specified under 2–201.11(A)(4)(a) through (d) or 2–201.11(A)(5)(a) through (d), restrict the food employee who works in a retail food establishment serving a highly susceptible population. **P**

2–201.13 Removal, Adjustment, or Retention of Exclusions and Restrictions.

The person in charge shall adhere to the following conditions when removing, adjusting, or retaining the exclusion or restriction of a food employee:

(A) Except when a food employee is diagnosed with Typhoid fever or an infection from hepatitis A virus:

(1) Reinstate a food employee who was excluded as specified under 2–201.12(A)(1) if the food employee:

(a) Is asymptomatic for at least twenty-four (24) hours; **P** or

(b) Provides to the person in charge written medical documentation from a health practitioner that states the symptom is from a noninfectious condition. **P**

(2) If a food employee was diagnosed with an infection from Norovirus and excluded as specified under 2–201.12(A)(2):

(a) Restrict the food employee, who is asymptomatic for at least twenty-four (24) hours and works in a retail food establishment not serving a highly susceptible population, until the conditions for reinstatement as specified under (D)(1) or (2) of this section are met; **P** or

(b) Retain the exclusion for the food employee, who is asymptomatic for at least twenty-four (24) hours and works in a retail food establishment that serves a highly susceptible population, until the conditions for reinstatement as specified under (D)(1) or (2) of this section are met. **P**

(3) If a food employee was diagnosed with an infection from *Shigella* spp. and excluded as specified under 2–201.12(A)(2):

(a) Restrict the food employee, who is asymptomatic for at least twenty-four (24) hours and works in a retail food establishment not serving a highly susceptible population, until the conditions for reinstatement as specified under (E)(1) or (2) of this section are met; **P** or

(b) Retain the exclusion for the food employee, who is asymptomatic for at least twenty-four (24) hours and works in a retail food establishment that serves a highly susceptible population, until the conditions for reinstatement as specified under (E)(1) or (2) or (E)(1) and (3)(a) of this section are met. **P**

(4) If a food employee was diagnosed with an infection from Shiga toxin-producing *Escherichia coli* and excluded as specified under 2-201.12(A)(2):

(a) Restrict the food employee, who is asymptomatic for at least twenty-four (24) hours and works in a retail food establishment not serving a highly susceptible population, until the conditions for reinstatement as specified under (F)(1) or (2) of this section are met; **P** or

(b) Retain the exclusion for the food employee, who is asymptomatic for at least twenty-four (24) hours and works in a retail food establishment that serves a highly susceptible population, until the conditions for reinstatement as specified under (F)(1) or (2) are met. **P**

(5) If a food employee was diagnosed with an infection from *Salmonella* (nontyphoidal) and excluded as specified under 2-201.12(A)(2):

(a) Restrict the food employee, who is asymptomatic for at least thirty (30) days, until conditions for reinstatement as specified under (G)(1) or (2) of this section are met; **P** or

(b) Retain the exclusion for the food employee who is symptomatic, until conditions for reinstatement as specified under Paragraphs (G)(1) or (G)(2) of this section are met. **P**

(B) Reinstatement a food employee who was excluded as specified under 2-201.12(B) if the person in charge obtains approval from the Department and one of the following conditions is met;

(1) The food employee has been jaundiced for more than seven (7) calendar days; **P**

(2) The anicteric food employee has been symptomatic with symptoms other than jaundice for more than fourteen (14) calendar days; **P** or

(3) The food employee provides to the person in charge written medical documentation from a health practitioner stating that the food employee is free of a Hepatitis A virus infection. **P**

(C) Reinstatement a food employee who was excluded as specified under 2-201.12(C) if the food employee provides to the person in charge written medical documentation from a health practitioner that states the food employee is free from Typhoid fever. **P**

(D) Reinstatement a food employee who was excluded as specified under 2-201.12(A)(2) or (D)(1) who was restricted under 2-201.12(D)(2) if:

(1) The excluded or restricted food employee provides to the person in charge written medical documentation from a health practitioner stating that the food employee is free of a Norovirus infection; **P**

(2) The food employee was excluded or restricted after symptoms of vomiting or diarrhea resolved and more than forty-eight (48) hours have passed since the food employee became asymptomatic; **P** or

(3) The food employee was excluded or restricted and did not develop symptoms and more than forty-eight (48) hours have passed since the food employee was diagnosed. **P**

(E) Reinstatement a food employee who was excluded as specified under 2-201.12(A)(2) or (E)(1) or who was restricted under 2-201.12(E)(2) if one of the following conditions is met:

(1) The excluded or restricted food employee provides to the person in charge written medical documentation from a health practitioner stating that the food employee is free of a *Shigella* spp. infection based on test results showing two (2) consecutive negative stool specimen cultures that are taken:

(a) Not earlier than forty-eight (48) hours after discontinuance of antibiotics, **P** and

(b) At least twenty-four (24) hours apart; **P**

(2) The food employee was excluded or restricted after symptoms of vomiting or diarrhea resolved, and more than seven (7) calendar days have passed since the food employee became asymptomatic; **P** or

(3) The food employee was excluded or restricted and did not develop symptoms and more than seven (7) calendar days have passed since the food employee was diagnosed. **P**

(F) Reinstatement of a food employee who was excluded or restricted as specified under 2-201.12(A)(2) or (F)(1) or who was restricted under 2-201.12(F)(2) if one of the following conditions is met:

(1) The excluded or restricted food employee provides to the person in charge written medical documentation from a health practitioner stating that the food employee is free of an infection from Shiga toxin-producing *Escherichia coli* based on test results that show two (2) consecutive negative stool specimen cultures that are taken:

(a) Not earlier than forty-eight (48) hours after discontinuance of antibiotics; **P** and

(b) At least twenty-four (24) hours apart; **P**

(2) The food employee was excluded or restricted after symptoms of vomiting or diarrhea resolved and more than seven (7) calendar days have passed since the food employee became asymptomatic; **P** or

(3) The food employee was excluded or restricted and did not develop symptoms and more than seven (7) days have passed since the food employee was diagnosed. **P**

(G) Reinstatement of a food employee who was excluded as specified under 2-201.12(A)(2) or who was restricted as specified under 2-201.12(G) if one of the following conditions is met:

(1) The excluded or restricted food employee provides to the person in charge written medical documentation from a health practitioner stating that the food employee is free of a *Salmonella* (nontyphoidal) infection based on test results showing two (2) consecutive negative stool specimen cultures that are taken;

(a) Not earlier than forty-eight (48) hours after discontinuance of antibiotics; **P** and

(b) At least twenty-four (24) hours apart; **P**

(2) The food employee was restricted after symptoms of vomiting or diarrhea resolved and more than thirty (30) days have passed since the food employee became asymptomatic; **P** or

(3) The food employee was excluded or restricted and did not develop symptoms and more than thirty (30) days have passed since the food employee was diagnosed. **P**

(H) Reinstatement of a food employee who was excluded or restricted as specified under 2-201.12(H)(1) or (2) if the food employee provides to the person in charge written medical documentation from a health practitioner stating that the food employee meets one of the following conditions:

(1) Has received antibiotic therapy for *Streptococcus pyogenes* infection for more than twenty-four (24) hours; **P**

(2) Has at least one negative throat specimen culture for *Streptococcus pyogenes* infection; **P** or

(3) Is otherwise determined by a health practitioner to be free of a *Streptococcus pyogenes* infection. **P**

(I) Reinstatement of a food employee who was restricted as specified under 2-201.12(I) if the skin, infected wound, cut, or pustular boil is properly covered with one of the following:

(1) An impermeable cover such as a finger cot or stall and a single-use glove over the impermeable cover if the infected wound or pustular boil is on the hand, finger, or wrist; **P**

(2) An impermeable cover on the arm if the infected wound or pustular boil is on the arm; **P** or

(3) A dry, durable, tight-fitting bandage if the infected wound or pustular boil is on another part of the body. **P**

(J) Reinstatement of a food employee who was restricted as specified under 2-201.12(J) and was exposed to one of the following pathogens as specified under 2-201.11(A)(4)(a) through (d) or 2-201.11(A)(5)(a) through (d):

(1) Norovirus and one of the following conditions is met:

(a) More than forty-eight (48) hours have passed since the last day the food employee was potentially exposed; **P** or

(b) More than forty-eight (48) hours have passed since the food employee's household contact became asymptomatic. **P**

(2) *Shigella* spp. or Shiga toxin-producing *Escherichia coli* and one of the following conditions is met:

(a) More than three (3) calendar days have passed since the last day the food employee was potentially exposed; **P** or

(b) More than three (3) calendar days have passed since the food employee's household contact became asymptomatic. **P**

(3) Typhoid fever (caused by *Salmonella* Typhi) and one of the following conditions is met:

(a) More than fourteen (14) calendar days have passed since the last day the food employee was potentially exposed; **P** or

(b) More than fourteen (14) calendar days have passed since the food employee's household contact became asymptomatic. **P**

(4) Hepatitis A virus and one of the following conditions is met:

(a) The food employee is immune to Hepatitis A virus infection because of a prior illness from Hepatitis A; **P**

(b) The food employee is immune to Hepatitis A virus infection because of vaccination against Hepatitis A; **P**

(c) The food employee is immune to Hepatitis A virus infection because of IgG administration; **P**

(d) More than thirty (30) calendar days have passed since the last day the food employee was potentially exposed; **P**

(e) More than thirty (30) calendar days have passed since the food employee's household contact became jaundiced; **P** or

(f) The food employee does not use an alternative procedure that allows bare hand contact with ready-to-eat food until at least thirty (30) days after the potential exposure as specified in (I)(4)(d) and (e) of this section, and the food employee receives additional training about:

(i) Hepatitis A symptoms and preventing the transmission of infection, **P**

(ii) Proper handwashing procedures, **P** and

(iii) Protecting ready-to-eat food from contamination introduced by bare hand contact. **P**

2-201.120 Departmental Action - Disease Transmission Known or Suspected.

(A) When the Department knows or has reasonable cause to suspect transmission of an enteric foodborne disease by a food employee of a facility, the Department may secure a medical history of the suspected food employee or make any other investigation necessary.

(B) The Department may require any or all of the following measures:

(1) The immediate exclusion of the food employee from employment in retail food establishments;

(2) The Department can declare an imminent health hazard requiring the immediate closure of the retail food establishment or any section thereof until no further danger of disease transmission exists;

(3) Restriction of the food employee's services to some other activity in the retail food establishment where there would be no danger of transmitting disease;

(4) Medical and laboratory examination of the food employee;

(5) Laboratory examination of food samples and environmental swabs from the retail food establishment.

2-3 PERSONAL CLEANLINESS

2-301 Hands and Arms

2-301.11 Clean Condition.

Food employees shall keep their hands and exposed portions of their arms clean. **P**

2-301.12 Cleaning Procedure.

(A) Except as specified in (D) of this section, food employees shall clean their hands and exposed portions of their arms, including surrogate prosthetic devices for hands or arms, for at least twenty (20) seconds, using a cleaning compound in a handwashing sink that is equipped as specified under 5-202.12 and 6-301.**P**

(B) Food employees shall use the following cleaning procedure in the order stated to clean their hands and exposed portions of their arms, including surrogate prosthetic devices for hands and arms:

- (1) Rinse under clean, running warm water; **P**
- (2) Apply an amount of cleaning compound recommended by the cleaning compound manufacturer; **P**
- (3) Rub together vigorously for at least ten (10) to fifteen (15) seconds while:
 - (a) Paying particular attention to removing soil from underneath the fingernails during the cleaning procedure, **P** and
 - (b) Creating friction on the surfaces of the hands and arms or surrogate prosthetic devices for hands and arms, finger-tips, and areas between the fingers; **P**
- (4) Thoroughly rinse under clean, running warm water; **P** and
- (5) Immediately follow the cleaning procedure with thorough drying using a method as specified under 6-301.12.**P**

(C) To avoid recontaminating their hands or surrogate prosthetic devices, food employees may use disposable paper towels or similar clean barriers when touching surfaces such as manually operated faucet handles on a handwashing sink or the handle of a restroom door.

(D) If approved and capable of removing the types of soils encountered in the food operations involved, an automatic handwashing facility may be used by food employees to clean their hands or surrogate prosthetic devices.

2-301.14 When to Wash.

Food employees shall clean their hands and exposed portions of their arms as specified under 2-301.12 immediately before engaging in food preparation including working with exposed food, clean equipment and utensils, and unwrapped single-service and single-use articles^P and:

- (A) After touching bare human body parts other than clean hands and clean, exposed portions of arms;^P
- (B) After using the toilet room; **P**
- (C) After caring for or handling service animals, pets, or aquatic animals as specified in 2-403.11(B);^P
- (D) Except as specified in 2-401.11(B) after coughing, sneezing, using a handkerchief or disposable tissue, using tobacco, eating, or drinking; **P**
- (E) After handling soiled equipment or utensils; **P**
- (F) During food preparation as often as necessary to remove soil and contamination and to prevent cross contamination when changing tasks; **P**
- (G) When switching between working with raw food and working with ready-to-eat food; **P**
- (H) Before donning gloves to initiate a task that involves working with food; **P** and
- (I) After engaging in other activities that contaminate the hands. **P**

2-301.15 Where to Wash.

Food employees shall clean their hands in a handwashing sink or approved automatic handwashing facility and may not clean their hands in a sink used for food preparation or warewashing or in a service sink or a curbed cleaning facility used for the disposal of mop water and similar liquid waste. **Pf**

2-301.16 Hand Antiseptics.

(A) A hand antiseptic used as a topical application, a hand antiseptic solution used as a hand dip, or a hand antiseptic soap shall:

(1) Comply with one of the following:

(a) Be an approved drug that is listed in the FDA publication *Approved Drug Products with Therapeutic Equivalence Evaluations* as an approved drug based on safety and effectiveness; **Pf** or

(b) Have active antimicrobial ingredients that are listed in the FDA monograph for *OTC Health-Care Antiseptic Drug Products* as an antiseptic handwash, **Pf** and

(2) Consist only of components which the intended use of each complies with one of the following:

(a) A threshold of regulation exemption under 21 CFR 170.39, *Threshold of Regulation for Substances Used in Food-Contact Articles*; **Pf** or

(b) 21 CFR 178, *Indirect Food Additives: Adjuvants, Production Aids, and Sanitizers* as regulated for use as a food additive with conditions of safe use; **Pf** or

(c) A determination of generally recognized as safe (GRAS). Partial listings of substances with food uses that are GRAS may be found in 21 CFR 182, *Substances Generally Recognized as Safe*, 21 CFR 184, *Direct Food Substances Affirmed as Generally Recognized as Safe*, or 21 CFR 186, *Indirect Food Substances Affirmed as Generally Recognized as Safe for Use in Contact with Food*, and in FDA's *Inventory of GRAS Notices*; **Pf** or

(d) A prior sanction listed under 21 CFR 181, *Prior Sanctioned Food Ingredients*; **Pf** or

(e) a *Food Contact Notification* that is effective, **Pf** and

(3) Be applied only to hands that are cleaned as specified under 2-301.12. **Pf**

(B) If a hand antiseptic does not meet the criteria specified under (A)(2) of this section, use shall be:

(1) Followed by thorough hand rinsing in clean water before hand contact with food or by the use of gloves; **Pf** or

(2) Limited to situations that involve no direct contact with food by the bare hands. **Pf**

(C) A hand antiseptic solution used as a hand dip shall be maintained clean and at a strength equivalent to at least 100 MG/L chlorine. **Pf**

2-302 Fingernails

2-302.11 Maintenance.

(A) Food employees shall keep their fingernails trimmed, filed, and maintained so the edges and surfaces are cleanable and not rough. Nail length shall not extend beyond the fingertips. **Pf**

(B) Unless wearing intact gloves in good repair, a food employee may not wear fingernail polish or artificial fingernails when working with exposed food. **Pf**

2-303 Jewelry

2-303.11 Prohibition.

(A) Except for a plain ring such as a wedding band, while preparing food, food employees shall not wear jewelry, including medical information jewelry, on their arms or hands.

(B) If jewelry cannot be removed for medical or religious reasons, it must be covered with a clean intact single-use glove when working with food.

2-304 Outer Clothing

2-304.11 Clean Condition.

Food employees shall wear clean outer clothing to prevent contamination of food, equipment, utensils, linens, and single-service and single-use articles.

2-4 HYGIENIC PRACTICES

2-401 Food Contamination Prevention

2-401.11 Eating, Drinking, or Using Tobacco.

(A) Except as specified in (B) of this section, an employee shall eat, drink, or use any form of tobacco only in designated areas where the contamination of exposed food, clean equipment, utensils, linens, unwrapped single-service and single-use articles or other items needing protection cannot result.

(B) A food employee may drink from a closed beverage container if the container is handled to prevent contamination of:

- (1) The food employee's hands;
- (2) The container; and
- (3) Exposed food, clean equipment, utensils, and linens; and unwrapped single-service and single-use articles.

2-401.12 Discharges from the Eyes, Nose, and Mouth.

Food employees experiencing persistent sneezing, coughing, or a runny nose that causes discharges from the eyes, nose, or mouth shall not work with exposed food, clean equipment, utensils, linens, or unwrapped single-service or single-use articles.

2-401.13 Use of Bandages, Finger Cots, or Finger Stalls.

If used, an impermeable cover such as a bandage, finger cot, or finger stall located on the wrist, hand, or finger of a food employee working with exposed food shall be covered with a single-use glove.

2-402 Hair Restraints

2-402.11 Effectiveness.

(A) Except as provided in (B) of this section, food employees shall wear hair restraints such as hats, hair covering and nets, beard restraints, and clothing that covers body hair that are designed and worn to effectively keep their hair from contacting exposed food, clean equipment, utensils, linens, and unwrapped single-service or single-use articles.

(B) This section does not apply to food employees such as counter staff who only serve beverages and wrapped or packaged food, hostesses, and wait staff, if they present a minimal risk of contaminating exposed food, clean equipment, utensils, linens and unwrapped single-service or single-use articles.

2-403 Animals

2-403.11 Handling Prohibition.

(A) Except as specified in (B) of this section, food employees may not care for or handle animals that may be present such as patrol dogs, service animals, or pets that are allowed as specified in 6-501.115 (B)(2) through (5) or section 9-3 "Outdoor Pet Dining". **Pf**

(B) Food employees with service animals may handle or care for their service animals, and food employees may handle or care for fish in aquariums or molluscan shellfish or crustacean in display tanks, if they wash their hands as specified in 2-301.12 and 2-301.14(C).

2-5 RESPONDING TO CONTAMINATION EVENTS

2-501 Procedures for Responding

2-501.11 Clean-up of Vomiting and Diarrheal Events.

A retail food establishment shall have written procedures for employees to follow when responding to vomiting or diarrheal events that involve the discharge of vomitus or fecal matter onto surfaces in the retail food establishment. The procedures shall address the specific actions employees must take to minimize the spread of contamination and the exposure of employees, consumers, food, and surfaces to vomitus or fecal matter. **Pf**

Chapter 3 Food

3-1 CHARACTERISTICS

3-101 Condition

3-101.11 Safe, Unadulterated, and Honestly Presented.

Food shall be safe, unadulterated, and, as specified under 3-601.12, honestly presented. **P**

3-2 SOURCES, SPECIFICATIONS, AND ORIGINAL CONTAINERS AND RECORDS

3-201 Sources

3-201.11 Compliance with Food Law.

(A) Food shall be obtained from sources that comply with law. **P**

(B) Food prepared in a private home shall not be used or offered for human consumption in a retail food establishment. **P**

(C) Packaged food shall be labeled as specified in law, including 21 CFR 101, *Food Labeling*, 9 CFR 317, *Labeling, Marking Devices, and Containers*, and 9 CFR 381 Subpart N, *Labeling and Containers*, and as specified under 3-202.17 and 3-202.18. **Pf**

(D) Fish, other than those specified in 3-402.11(B), that are intended for consumption in raw or undercooked form and allowed as specified in 3-401.11(D), may be offered for sale or service if they are obtained from a supplier that freezes the fish as specified under 3-402.11 or if they are frozen on the premises as specified under 3-402.11 and records are retained as specified under 3-402.12.

(E) Whole-muscle, intact beef steaks that are intended for consumption in an undercooked form without a consumer advisory as specified in 3-401.11(C) shall be:

(1) Obtained from a food processing plant that, upon request by the purchaser, packages the steaks and labels them to indicate that the steaks meet the definition of whole-muscle, intact beef, **Pf** or

(2) Deemed acceptable by the Department based on other evidence, **Pf**

(3) If individually cut in a retail food establishment:

(a) Cut from whole-muscle intact beef that is labeled by a food processing plant as specified in (E)(1) of this section or identified as specified in (E)(2) of this section, **P**

(b) Prepared so they remain intact, **Pf** and

(c) If packaged for undercooking in a retail food establishment, labeled as specified in (E)(1) of this section or identified as specified in (E)(2) of this section. **Pf**

(F) Meat and poultry that is not a ready-to-eat food and is in a packaged form when it is offered for sale or otherwise offered for consumption shall be labeled to include safe handling instructions as specified in law, including 9 CFR 317.2(l) and 9 CFR 381.125(b).

(G) Eggs that have not been specifically treated to destroy all viable *Salmonellae* shall be labeled to include safe handling instructions as specified in law, including 21 CFR 101.17(h).

3-201.12 Food in a Hermetically Sealed Container.

Food in a hermetically sealed container shall be obtained from a food processing plant that is regulated by the food regulatory agency that has jurisdiction over the plant. **P**

3-201.13 Fluid Milk, Dry Milk, and Milk Products.

Fluid milk, dry milk, and milk products shall be obtained from sources that comply with Grade A standards as specified in law. **P**

3-201.14 Fish.

(A) Fish that are received for sale or service shall be:

(1) Commercially and legally caught or harvested, **P** or

(2) Approved for sale or service. **P**

(B) Molluscan shellfish that are recreationally caught may not be received for sale or service. **P**

3-201.15 Molluscan Shellfish.

(A) Molluscan shellfish shall be obtained from sources according to law and the requirements specified in the U.S. Department of Health and Human Services, Public Health Service, Food and Drug Administration, *National Shellfish Sanitation Program Guide for the Control of Molluscan Shellfish*. **P**

(B) Molluscan shellfish received in interstate commerce shall be from sources that are listed in the *Interstate Certified Shellfish Shippers List*. **P**

3-201.16 Wild Mushrooms.

(A) Except as specified in (B) of this section, mushroom species picked in the wild shall be obtained from sources where each mushroom is individually inspected and found to be safe by an approved mushroom identification expert as specified in 9–4, *Wild Mushroom Foraging*. **P**

(B) This section does not apply to:

(1) Cultivated wild mushroom species that are grown, harvested, and processed in an operation that is regulated by the food regulatory agency that has jurisdiction over the operation; or

(2) Wild mushroom species, if they are in packaged form and are the product of a food processing plant that is regulated by the food regulatory agency that has jurisdiction over the plant.

3–201.17 Game Animals.

(A) If game animals are received for sale or service they shall be:

(1) Commercially raised for food **P** and:

(a) Raised, slaughtered, and processed under a voluntary inspection program that is conducted by the agency that has animal health jurisdiction, **P** or

(b) Under a routine inspection program conducted by a regulatory agency other than the agency that has animal health jurisdiction, **P** and

(c) Raised, slaughtered, and processed according to:

(i) Laws governing meat and poultry as determined by the agency that has animal health jurisdiction and the agency that conducts the inspection program, **P** and

(ii) Requirements which are developed by the agency that has animal health jurisdiction and the agency that conducts the inspection program with consideration of factors such as the need for antemortem and postmortem examination by an approved veterinarian or veterinarian's designee; **P**

(2) Under a voluntary inspection program administered by the USDA for game animals such as exotic animals (reindeer, elk, deer, antelope, water buffalo, or bison) that are "inspected and approved" in accordance with 9 CFR 352, *Exotic Animals*; voluntary inspection of rabbits that are "inspected and certified" in accordance with 9 CFR 354, *Voluntary Inspection Of Rabbits And Edible Products Thereof*; **P**

(3) As allowed by law for wild game animals that are live-caught:

(a) Under a routine inspection program conducted by a regulatory agency such as the agency that has animal health jurisdiction, **P** and

(b) Slaughtered and processed according to:

(i) Laws governing meat and poultry as determined by the agency that has animal health jurisdiction and the agency that conducts the inspection program, **P** and

(ii) Requirements which are developed by the agency that has animal health jurisdiction and the agency that conducts the inspection program with consideration of factors such as the need for antemortem and postmortem examination by an approved veterinarian or veterinarian's designee; **P** or

(4) As allowed by law, for field-dressed wild game animals under a routine inspection program that ensures the animals:

(a) Receive a postmortem examination by an approved veterinarian or veterinarian's designee, **P** or

(b) Are field-dressed and transported according to requirements specified by the agency that has animal health jurisdiction and the agency that conducts the inspection program, **P** and

(c) Are processed according to laws governing meat and poultry as determined by the agency that has animal health jurisdiction and the agency that conducts the inspection program. **P**

(B) A game animal may not be received for sale or service if it is a species of wildlife that is listed in 50 CFR 17, *Endangered and Threatened Wildlife and Plants*.

3–202 Specifications for Receiving

3–202.11 Temperature.

(A) Except as specified in (B) of this section, refrigerated, time/temperature control for safety food shall be at a temperature of 41 degree F (5 degree C) or below when received. **P**

(B) If a temperature other than 41 degree F (5 degree C) for a time/temperature control for safety food is specified in law governing its distribution, such as laws governing milk and molluscan shellfish, the food may be received at the specified temperature.

(C) Raw eggs shall be received in refrigerated equipment that maintains an ambient air temperature of 45 degrees F (7 degrees C) or less. **P**

(D) Time/temperature control for safety food that is cooked to a temperature and for a time specified under 3–401.11 through 3–401.13 and received hot shall be at a temperature of 135 degrees F (57 degrees C) or above. **P**

(E) A food that is labeled frozen and shipped frozen by a food processing plant shall be received frozen. **Pf**

(F) Upon receipt, time/temperature control for safety food shall be free of evidence of previous temperature abuse. **Pf**

3–202.12 Additives.

Food may not contain unapproved food additives or additives that exceed amounts specified in 21 CFR 170–180 relating to *Food Additives, Generally Recognized as Safe* or prior sanctioned substances that exceed amounts specified in 21 CFR 181 through 186, substances that exceed amounts specified in 9 CFR Subpart C Section 424.21(b), *Food Ingredients and Sources of Radiation*, that exceed provisions specified in 40 CFR 180, *Tolerances for Pesticides Chemicals in Food, and Exceptions*. **P**

3–202.13 Eggs.

Eggs shall be received clean and sound and shall not exceed the restricted egg tolerances for U.S. Consumer Grade B as specified in *United States Standards, Grades, and Weight Classes for Shell Eggs*, AMS 56.200 et seq., administered by the Agricultural Marketing Service of USDA. **P**

3–202.14 Egg and Milk Products, Pasteurized.

(A) Egg products shall be obtained pasteurized. **P**

(B) Fluid and dry milk and milk products used and served shall, except as specified in (E) of this section:

(1) Be obtained pasteurized; **P** and

(2) Comply with Grade A standards as specified in law. **P**

(C) Frozen milk products, such as ice cream, shall be obtained pasteurized as specified in 21 CFR 135, *Frozen desserts*. **P**

(D) Cheese shall be obtained pasteurized unless alternative procedures to pasteurization are specified in the CFR, such as 21 CFR 133, *Cheeses and Related Cheese Products*, for curing certain cheese varieties. **P**

(E) Packaged raw milk may be obtained for re-sale provided it meets the requirements of R.61–34, *Raw Milk for Human Consumption*.

3–202.15 Package Integrity.

Food packages shall be in good condition and protect the integrity of the contents so that the food is not exposed to adulteration or potential contaminants. **Pf**

3–202.16 Ice.

Ice for use as a food or cooling medium shall be made from drinking water. **P**

3–202.17 Shucked Shellfish, Packing and Identification.

(A) Raw shucked shellfish shall be obtained in nonreturnable packages which bear a legible label that identifies the **Pf**:

(1) Name, address, and certification number of the shucker, packer, or repacker of the molluscan shellfish and

(2) The “sell by” or “best if used by” date for packages with a capacity of less than 1.89 L (one-half gallon) or the date shucked for packages with a capacity of 1.89 L (one-half gallon) or more. **Pf**

(B) A package of raw shucked shellfish that does not bear a label or which bears a label which does not contain all the information as specified under (A) of this section shall be subject to a hold order, as allowed by law, or seizure and destruction in accordance with 21 CFR Subpart D, *Specific Administrative Decisions Regarding Interstate Shipments*, Section 1240.60(d), *Molluscan Shellfish*.

3-202.18 Shellstock Identification.

(A) Shellstock shall be obtained in containers bearing legible source identification tags or labels that are affixed by the harvester or dealer that depurates, ships, or reships the shellstock, as specified in the *National Shellfish Sanitation Program Guide for the Control of Molluscan Shellfish*, and that list: **Pf**

(1) Except as specified under (C) of this section, on the harvester's tag or label, the following information in the following order:

(a) The harvester's identification number that is assigned by the shellfish control authority, **Pf**

(b) The date of harvesting, **Pf**

(c) The most precise identification of the harvest location or aquaculture site that is practicable based on the system of harvest area designations that is in use by the shellfish control authority and including the abbreviation of the name of the state or country in which the shellfish are harvested, **Pf**

(d) The type and quantity of shellfish, **Pf** and

(e) The following statement in bold, capitalized type: "This tag is required to be attached until container is empty or retagged and thereafter kept on file for ninety (90) days"; **Pf** and

(2) Except as specified in (D) of this section, on each dealer's tag or label, the following information in the following order: **Pf**

(a) The dealer's name, address, and the certification number assigned by the shellfish control authority, **Pf**

(b) The original shipper's certification number including the abbreviation of the name of the state or country in which the shellfish are harvested, **Pf**

(c) The same information as specified for a harvester's tag under (A)(1)(b) through (d) of this section, **Pf** and

(d) The following statement in bold, capitalized type: "This tag is required to be attached until container is empty and thereafter kept on file for ninety (90) days." **Pf**

(B) A container of shellstock that does not bear a tag or label or that bears a tag or label that does not contain all the information as specified under (A) of this section shall be subject to a hold order, as allowed by law, or seizure and destruction in accordance with 21 CFR Subpart D, *Specific Administrative Decisions Regarding Interstate Shipments*, Section 1240.60(d), *Molluscan Shellfish*.

(C) If a place is provided on the harvester's tag or label for a dealer's name, address, and certification number, the dealer's information shall be listed first.

(D) If the harvester's tag or label is designed to accommodate each dealer's identification as specified under (A)(2)(a) and (b) of this section, individual dealer tags or labels need not be provided.

(E) The statement "Keep Refrigerated" or an equivalent statement must be included on the tag.

3-202.19 Shellstock Condition.

When received by a retail food establishment, shellstock shall be reasonably free of mud, dead shellfish, and shellfish with broken shells. Dead shellfish or shellstock with badly broken shells shall be discarded.

3-202.110 Juice Treated.

Pre-packaged juice shall:

(A) Be obtained from a processor with a HACCP system as specified in 21 CFR Part 120, *Hazard Analysis and Critical Control (HACCP) Systems*; **Pf** and

(B) Be obtained pasteurized or otherwise treated to attain a 5-log reduction of the most resistant microorganism of public health significance as specified in 21 CFR Part 120.24, *Process Controls*.**P**

3-203 Original Containers and Records

3-203.11 Molluscan Shellfish, Original Container.

(A) Except as specified in (B) through (D) of this section, molluscan shellfish may not be removed from the container in which they are received other than immediately before sale or preparation for service.

(B) For display purposes, shellstock may be removed from the container in which they are received, displayed on drained ice, or held in a display container, and a quantity specified by a consumer may be removed from the display or display container and provided to the consumer if:

(1) The source of the shellstock on display is identified as specified under 3-202.18 and recorded as specified under 3-203.12 and

(2) The shellstock are protected from contamination.

(C) Shucked shellfish may be removed from the container in which they were received and held in a display container from which individual servings are dispensed upon a consumer's request if:

(1) The labeling information for the shellfish on display as specified under 3-202.17 is retained and correlated to the date when or dates during which the shellfish are sold or served, and

(2) The shellfish are protected from contamination.

(D) Shucked shellfish may be removed from the container in which they were received and repacked in consumer self-service containers where allowed by law if:

(1) The labeling information for the shellfish is on each consumer self-service container as specified under 3-202.17 and 3-602.11;

(2) The labeling information as specified under 3-202.17 is retained and correlated with the date when or dates during which the shellfish are sold or served;

(3) The labeling information and dates specified under (D)(2) of this section are maintained for ninety (90) days; and

(4) The shellfish are protected from contamination.

3-203.12 Shellstock, Maintaining Identification.

(A) Except as specified under (C)(2) of this section, shellstock tags or labels shall remain attached to the container in which the shellstock are received until the container is empty. **Pf**

(B) The date when the last shellstock from the container is sold or served shall be recorded on the tag or label. **Pf**

(C) The identity of the source of shellstock that are sold or served shall be maintained by retaining shellstock tags or labels for ninety (90) calendar days from the date that is recorded on the tag or label, as specified under (B) of this section, by: **Pf**

(1) Using an approved record keeping system that keeps the tags or labels in chronological order correlated to the date that is recorded on the tag or label, as specified under (B) of this section; **Pf** and

(2) If shellstock are removed from its tagged or labeled container:

(a) Preserving source identification by using a record keeping system as specified under (C)(1) of this section, **Pf** and

(b) Ensuring that shellstock from one tagged or labeled container are not commingled with shellstock from another container with different certification numbers, different harvest dates, or different growing areas as identified on the tag or label before being ordered by the consumer. **Pf**

3-3 PROTECTION FROM CONTAMINATION AFTER RECEIVING

3-301 Preventing Contamination by Employees

3-301.11 Preventing Contamination from Hands.

(A) Food employees shall wash their hands as specified under 2-301.12.

(B) Except when washing fruits and vegetables as specified under 3-302.15 or as specified in (D) of this section, food employees may not contact exposed, ready-to-eat food with their bare hands and shall use suitable utensils such as deli tissue, spatulas, tongs, single-use gloves, or dispensing equipment. **P**

(C) Food employees shall minimize bare hand and arm contact with exposed food that is not in a ready-to-eat form. **Pf**

(D) Paragraph (B) of this section does not apply to a food employee who contacts exposed, ready-to-eat food with bare hands at the time the ready-to-eat food is being added as an ingredient to a food that:

(1) Contains a raw animal food and is to be cooked in the retail food establishment to heat all parts of the food to the minimum temperatures specified in 3-401.11(A) and (B) or 3-401.12, or

(2) Does not contain a raw animal food but is to be cooked in the retail food establishment to heat all parts of the food to a temperature of at least 145 degree F (63 degree C).

3-301.12 Preventing Contamination When Tasting.

A food employee may not use a utensil more than once to taste food that is to be sold or served. **P**

3-302 Preventing Food and Ingredient Contamination

3-302.11 Packaged and Unpackaged Food - Separation, Packaging, and Segregation.

(A) Food shall be protected from cross contamination by:

(1) Except as specified in (1)(d) below, separating raw animal foods during storage, preparation, holding, and display from:

(a) Raw ready-to-eat food including other raw animal food such as fish for sushi or molluscan shellfish, or other raw ready-to-eat food such as fruits and vegetables, **P** and

(b) Cooked ready-to-eat food; **P** and

(c) Fruits and vegetables before they are washed; **P** and

(d) Frozen, commercially processed and packaged raw animal food may be stored or displayed with or above frozen, commercially processed and packaged, ready-to-eat food.

(2) Except when combined as ingredients, separating types of raw animal foods from each other such as beef, fish, lamb, pork, and poultry during storage, preparation, holding, and display by:

(a) Using separate equipment for each type, **P** or

(b) Arranging each type of food in equipment so that cross contamination of one type with another is prevented, **P** and

(c) Preparing each type of food at different times or in separate areas; **P**

(3) Cleaning equipment and utensils as specified under 4-602.11(A) and sanitizing as specified under 4-703.11;

(4) Except as specified under 3-501.15(B)(2) and in (B) of this section, storing the food in packages, covered containers, or wrappings;

(5) Cleaning hermetically sealed containers of food of visible soil before opening;

(6) Protecting food containers that are received packaged together in a case or overwrap from cuts when the case or overwrap is opened;

(7) Storing damaged, spoiled, or recalled food being held in the retail food establishment as specified under 6-404.11; and

(8) Separating fruits and vegetables before they are washed, as specified under 3-302.15, from ready-to-eat food.

(B) Subparagraph (A)(4) of this section does not apply to:

(1) Whole, uncut, raw fruits and vegetables and nuts in the shell that require peeling or hulling before consumption;

(2) Primal cuts, quarters, or sides of raw meat or slab bacon that are hung on clean, sanitized hooks or placed on clean, sanitized racks;

(3) Whole, uncut, processed meats such as country hams and smoked or cured sausages that are placed on clean, sanitized racks;

(4) Food being cooled as specified under 3-501.15(B)(2); or

(5) Shellstock.

3-302.12 Food Storage Containers, Identified with Common Name of Food.

Except for containers holding food that can be readily and unmistakably recognized, such as dry pasta, working containers holding food or food ingredients that are removed from their original packages for use in the retail food establishment, such as cooking oils, flour, herbs, potato flakes, salt, spices, and sugar, shall be identified with the common name of the food.

3-302.13 Pasteurized Eggs, Substitute for Raw Eggs for Certain Recipes.

Pasteurized eggs or egg products shall be substituted for raw eggs in the preparation of foods such as Caesar salad, hollandaise or Béarnaise sauce, mayonnaise, meringue, eggnog, ice cream, and egg-fortified beverages that are not: **P**

(A) Cooked as specified under 3-401.11(A)(1) or (2); **P** or

(B) Included in 3-401.11(D). **P**

3-302.14 Protection from Unapproved Additives.

(A) Food shall be protected from contamination that may result from the addition of, as specified in 3-202.12:

(1) Unsafe or unapproved food or color additives; **P** and

(2) Unsafe or unapproved levels of approved food and color additives. **P**

(B) A food employee may not:

(1) Apply sulfiting agents to fresh fruits and vegetables intended for raw consumption or to a food considered to be a good source of vitamin B₁; **P** or

(2) Except for grapes, serve or sell food specified under (B)(1) of this section that is treated with sulfiting agents before receipt by the retail food establishment. **P**

3-302.15 Washing Fruits and Vegetables.

(A) Except as specified in (B) of this section and except for whole, raw fruits and vegetables that are intended for washing by the consumer before consumption, raw fruits and vegetables shall be thoroughly washed in water to remove soil and other contaminants before being cut, combined with other ingredients, cooked, served, or offered for human consumption in ready-to-eat form.

(B) Fruits and vegetables may be washed by using chemicals as specified under 7-204.12.

(C) Devices used for on-site generation of chemicals meeting the requirements specified in 21 CFR 173.315, *Chemicals Used in the Washing or to Assist in the Peeling of Fruits and Vegetables*, for the washing of raw, whole fruits and vegetables shall be used in accordance with the manufacturer's instructions. **PF**

3-303 Preventing Contamination from Ice Used as a Coolant

3-303.11 Ice Used as Exterior Coolant, Prohibited as Ingredient.

After use as a medium for cooling the exterior surfaces of food such as melons or fish, packaged foods such as canned beverages, or cooling coils and tubes of equipment, ice may not be used as food. **P**

3-303.12 Storage or Display of Food in Contact with Water or Ice.

(A) Packaged food may not be stored in direct contact with ice or water if the food is subject to the entry of water because of the nature of its packaging, wrapping, or container or its positioning in the ice or water.

(B) Except as specified in (C) and (D) of this section, unpackaged food may not be stored in direct contact with undrained ice.

(C) Whole, raw fruits or vegetables; cut, raw vegetables such as celery or carrot sticks or cut potatoes; and tofu may be immersed in ice or water.

(D) Raw poultry and raw fish that are received immersed in ice in shipping containers may remain in that condition while in storage awaiting preparation, display, service, or sale.

3-304 Preventing Contamination from Equipment, Utensils, and Linens

3-304.11 Food Contact with Equipment and Utensils.

Food shall only contact surfaces of:

(A) Equipment and utensils that are cleaned as specified under Section 4–6 of this regulation and sanitized as specified under Section 4–7 of this regulation; **P**

(B) Single-service and single-use articles; **P** or

(C) Linens, such as cloth napkins, as specified in 3–304.13 that are laundered as specified under Section 4–8 of this regulation. **P**

3–304.12 In-Use, Between-Use Storage.

During pauses in food preparation or dispensing, food preparation and dispensing utensils shall be stored:

(A) Except as specified under (B) of this section, in the food with their handles above the top of the food and the container;

(B) In food that is not a time/temperature control for safety food with their handles above the top of the food within containers or equipment that can be closed, such as bins of sugar, flour, or cinnamon;

(C) On a clean portion of the food preparation table or cooking equipment only if the in-use utensil and the food-contact surface of the food preparation table or cooking equipment are cleaned and sanitized at a frequency specified under 4–602.11 and 4–702.11;

(D) In running water of sufficient velocity to flush particulates to the drain, if used with moist food such as ice cream or mashed potatoes;

(E) In a clean, protected location if the utensils, such as ice scoops, are used only with a food that is not time/temperature control for safety food; or

(F) In a container of water if the water is maintained at a temperature of at least 135 degrees F (57 degrees C) and the container is cleaned at a frequency specified under 4–602.11(D)(7).

3–304.13 Linens and Napkins, Use Limitation.

Linens, such as cloth napkins, shall not be used in contact with food unless they are used to line a container for the service of foods and the linens and napkins are replaced each time the container is refilled for a new consumer.

3–304.14 Wiping Cloths, Use Limitation.

(A) Cloths in-use for wiping food spills from tableware and carry-out containers that occur as food is being served shall be:

(1) Maintained dry; and

(2) Used for no other purpose.

(B) Cloths in-use for wiping counters and other equipment surfaces shall be:

(1) Held between uses in a chemical sanitizer solution at a concentration specified under 4–501.114, and

(2) Laundered daily as specified under 4–802.11(D).

(C) Cloths in-use for wiping surfaces in contact with raw animal foods shall be kept separate from cloths used for other purposes.

(D) Dry wiping cloths and the chemical sanitizing solutions specified in (B)(1) of this section in which wet wiping cloths are held between uses shall be free of food debris and visible soil.

(E) Containers of chemical sanitizing solutions specified in (B)(1) of this section in which wet wiping cloths are held between uses shall be stored off the floor and used in a manner that prevents contamination of food, equipment, utensils, linens, single-service, or single-use articles.

(F) Single-use disposable sanitizer wipes shall be used in accordance with EPA-approved manufacturer's label use instructions.

3–304.15 Gloves, Use Limitation.

(A) If used, single-use gloves shall be used for only one task such as working with ready-to-eat food or with raw animal food, used for no other purpose, and discarded when damaged or soiled, or when interruptions occur in the operation. **P**

(B) Except as specified in (C) of this section, slash-resistant gloves that are used to protect the hands during operations requiring cutting shall be used in direct contact only with food that is subsequently cooked as specified under Section 3–4 such as frozen food or a primal cut of meat.

(C) Slash-resistant gloves may be used with ready-to-eat food that will not be subsequently cooked if the slash-resistant gloves have a smooth, durable, and nonabsorbent outer surface; or if the slash-resistant gloves are covered with a smooth, durable, nonabsorbent glove, or a single-use glove.

(D) Cloth gloves may not be used in direct contact with food unless the food is subsequently cooked as required under Section 3–4 such as frozen food or a primal cut of meat.

3–304.16 Using Clean Tableware for Second Portions and Refills.

(A) Except for refilling a consumer’s drinking cup or container without contact between the pouring utensil and the lip-contact area of the drinking cup or container, food employees may not use tableware, including single-service articles, soiled by the consumer to provide second portions or refills.

(B) Except as specified in (C) of this section, self-service consumers may not be allowed to use soiled tableware, including single-service articles, to obtain additional food from the display and serving equipment.

(C) Drinking cups and containers may be reused by self-service consumers if refilling is a contamination-free process as specified under 4–204.13(A), (B), and (D).

3–304.17 Refilling Returnables.

(A) Except as specified in (B) through (E) of this section, empty containers returned to a retail food establishment for cleaning and refilling with food shall be cleaned and refilled in a regulated food processing plant.^P

(B) A take-home food container returned to a retail food establishment may be refilled at a retail food establishment with food if the food container is:

- (1) Designed and constructed for reuse and in accordance with the requirements specified under Sections 4–1 and 4–2; ^P
- (2) One that was initially provided by the retail food establishment to the consumer, either empty or filled with food by the retail food establishment, for the purpose of being returned for reuse;
- (3) Returned to the retail food establishment by the consumer after use;
- (4) Subject to the following steps before being refilled with food:
 - (a) Cleaned as specified under Section 4–6 of this regulation;
 - (b) Sanitized as specified under Section 4–7 of this regulation;
 - (c) Visually inspected by a food employee to verify that the container, as returned, meets the requirements specified under Sections 4–1 and 4–2.^P

(C) A take-home food container returned to a retail food establishment may be refilled at a retail food establishment with beverage if:

- (1) The beverage is not a time/temperature control for safety food;
- (2) The design of the container, the rinsing equipment and the nature of the beverage, when considered together, allow effective cleaning at home or in the retail food establishment;
- (3) Facilities for rinsing before refilling returned containers with fresh, hot water that is under pressure and not recirculated are provided as part of the dispensing system;
- (4) The consumer-owned container returned to the retail food establishment for refilling is refilled for sale or service only to the same consumer; and
- (5) The container is refilled by:
 - (a) An employee of the retail food establishment, or
 - (b) The owner of the container, if the beverage system includes a contamination-free transfer process as specified under 4–204.13(A), (B), and (D) that cannot be bypassed by the container owner.

(D) Consumer-owned personal take-out beverage containers, such as thermally insulated bottles, nonspill coffee cups, and promotional beverage glasses, may be refilled by employees or the consumer if refilling is a contamination-free process as specified under 4-204.13(A), (B), and (D).

(E) Consumer-owned containers that are not food-specific may be filled at a water vending machine or system.

3-305 Preventing Contamination from the Premises

3-305.11 Food Storage.

(A) Except as specified in (B) and (C) of this section, food shall be protected from contamination by storing the food:

- (1) In a clean, dry location;
- (2) Where it is not exposed to splash, dust, or other contamination; and
- (3) At least 15 cm (6 inches) above the floor.

(B) Food in packages and working containers may be stored less than (6) inches (15 cm) above the floor on case lot handling equipment as specified under 4-204.122.

(C) Pressurized beverage containers, cased food in waterproof containers such as bottles or cans, and milk containers in plastic crates may be stored on a floor that is clean and not exposed to floor moisture.

3-305.12 Food Storage, Prohibited Areas.

Food shall not be stored:

- (A) In locker rooms;
- (B) In toilet rooms;
- (C) In dressing rooms;
- (D) In garbage rooms;
- (E) In mechanical rooms;
- (F) Under drain or sewer lines that are not shielded to intercept potential drips;
- (G) Under leaking water lines, including leaking automatic fire sprinkler heads, or under lines on which water has condensed;
- (H) Under open stairwells; or
- (I) Under other sources of contamination.

3-305.14 Food Preparation.

During preparation, unpackaged food shall be protected from environmental sources of contamination.

3-306 Preventing Contamination by Consumers

3-306.11 Food Display.

Except for nuts in the shell and whole, raw fruits and vegetables that are intended for hulling, peeling, or washing by the consumer before consumption, food on display shall be protected from contamination by the use of packaging; counter, service line, or salad bar food guards; display cases; or other effective means. ^P

3-306.12 Condiments, Protection.

Condiments shall be protected from contamination by being kept in dispensers that are designed to provide protection, protected food displays provided with the proper utensils, original containers designed for dispensing, or individual packages or portions.

3-306.13 Consumer Self-Service Operations.

(A) Raw, unpackaged animal food, such as beef, lamb, pork, poultry, and fish may not be offered for consumer self-service. ^P This paragraph does not apply to:

- (1) Consumer self-service of ready-to-eat foods at buffets or salad bars that serve foods such as sushi or raw shellfish;

(2) Ready-to-cook individual portions for immediate cooking and consumption on the premises such as consumer-cooked meats or consumer-selected ingredients for Mongolian barbecue; or

(3) Raw, frozen, shell-on shrimp, or lobster.

(B) Consumer self-service operations for ready-to-eat foods shall be provided with suitable utensils or effective dispensing methods that protect the food from contamination. **Pf**

(C) Consumer self-service operations such as buffets and salad bars shall be monitored by food employees trained in safe operating procedures. **Pf**

3-306.14 Returned Food and Re-Service of Food.

(A) Except as specified in (B) of this section, after being served or sold and in the possession of a consumer, food that is unused or returned by the consumer may not be offered as food for human consumption. **P**

(B) Except as specified under 3-801.11(G), a container of food that is not a time/temperature control for safety food may be re-served from one consumer to another if:

(1) The food is dispensed so that it is protected from contamination and the container is closed between uses, such as a narrow-neck bottle containing catsup, steak sauce, or wine; or

(2) The food, such as crackers, salt, or pepper, is in an unopened original package and is maintained in sound condition.

3-307 Preventing Contamination from Other Sources

3-307.11 Miscellaneous Sources of Contamination.

Food shall be protected from contamination that may result from a factor or source not specified under 3-301 through 3-306.

3-4 DESTRUCTION OF ORGANISMS OF PUBLIC HEALTH CONCERN

3-401 Cooking

3-401.11 Raw Animal Foods.

(A) Except as specified under (B), (C), and (D) of this section, raw animal foods such as eggs, fish, meat, poultry, and foods containing these raw animal foods shall be cooked to heat all parts of the food to a temperature and for a time that complies with one of the following methods based on the food that is being cooked:

(1) 145 degrees F (63 degrees C) or above for fifteen (15) seconds for: **P**

(a) Raw eggs that are broken and prepared in response to a consumer's order and for immediate service, **P** and

(b) Except as specified under (A)(2) and (A)(3) and (B), and in (C) of this section, fish and intact meat including game animals commercially raised for food as specified under 3-201.17(A)(1) and game animals under a voluntary inspection program as specified under 3-201.17(A)(2);**P**

(2) 155 degrees F (68 degrees C) for seventeen (17) seconds or the temperature specified in the following chart that corresponds to the holding time for ratites, mechanically tenderized, and injected meats; the following if they are comminuted: fish, meat, game animals commercially raised for food as specified under 3-201.17(A)(1), and game animals under a voluntary inspection program as specified under 3-201.17(A)(2); and raw eggs that are not prepared as specified under (A)(1)(a) of this section, that corresponds to that temperature in Table 3.1: **P**

Table 3.1 Minimum	
Temperature Degrees F (degrees C)	Time
145 (63)	3 minutes
150 (66)	1 minute
158 (70)	Less than 1 second (instantaneous)

; or

(3) 165 degrees F (74 degrees C) or above for less than one (1) second(instantaneous) for poultry, baluts, wild game animals as specified under 3-201.17(A)(3) and (4), stuffed fish, stuffed

meat, stuffed pasta, stuffed poultry, stuffed ratites, or stuffing containing fish, meat, poultry, or ratites. **P**

(B) Whole meat roasts including beef, corned beef, lamb, pork, and cured pork roasts such as ham shall be cooked:

(1) As specified in the following Table 3.2 to heat all parts of the food to a temperature and for the holding time that corresponds to that temperature: **P**

Temperature Degree F (C)	Time ¹ in Minutes	Temperature Degree F (C)	Time ¹ in Seconds
130 (54.4)	112	147 (63.9)	134
131 (55.0)	89	149 (65.0)	85
133 (56.1)	56	151 (66.1)	54
135 (57.2)	36	153 (67.2)	34
136 (57.8)	28	155 (68.3)	22
138 (58.9)	18	157 (69.4)	14
140 (60.0)	12	158 (70.0)	0
142 (61.1)	8		
144 (62.2)	5		
145 (62.8)	4		

¹ Holding time may include post-oven heat rise.

; and

(2) If cooked in an oven, use an oven that is preheated to the temperature specified for the roast's weight in the following Table 3.3 and that is held at that temperature. **Pf**

(C) A raw or undercooked whole-muscle, intact beef steak may be served or offered for sale in a ready-to-eat form if:

(1) The food establishment serves a population that is not a highly susceptible population,

(2) The steak is labeled to indicate that it meets the definition of "whole-muscle, intact beef" as specified under 3-201.11(E), and

Oven Type	Oven Temperature Based on Roast Weight	
	Less than 10 lbs (4.5 kg)	10 lbs (4.5 kg) or more
Still Dry	350 degrees F (177 degrees C) or more	250 degrees F (121 degrees C) or more
Convection	325 degrees F (163 degrees C) or more	250 degrees F (121 degrees C) or more
High Humidity ¹	250 degrees F (121 degrees C) or less	250 degrees F (121 degrees C) or less

¹ Relative humidity greater than 90 percent for at least 1 hour as measured in the cooking chamber, exit of the oven, or in a moisture-impermeable bag that provides 100 percent humidity.

(3) The steak is cooked on both the top and bottom to a surface temperature of 145 degrees F (63 degrees C) or above and a cooked color change is achieved on all external surfaces.

(D) A raw animal food, such as raw egg, raw fish, raw-marinated fish, raw molluscan shellfish, or steak tartare, or a partially cooked food, such as lightly cooked fish, soft cooked eggs, or rare meat other than whole-muscle, intact beef steaks, as specified in (C) of this section, may be served or offered for sale upon consumer request or selection in a ready-to-eat form if:

(1) As specified under 3-801.11(C)(1) and (2), the retail food establishment serves a population that is not a highly susceptible population;

(2) The food, if served or offered for service by consumer selection from a children's menu, does not contain comminuted meat; **Pf** and

(3) The consumer is informed as specified under 3-603.11 that to ensure its safety, the food should be cooked as specified under (A) or (B) of this section; or

(4) The Department grants a variance from (A) or (B) of this section as specified in 8-103.10 based on a HACCP plan that:

(a) Is submitted by the permit holder and approved as specified under 8-103.11,

(b) Documents scientific data or other information showing that a lesser time and temperature regimen results in a safe food, and

(c) Verifies that equipment and procedures for food preparation and training of food employees at the retail food establishment meet the conditions of the variance.

3-401.12 Microwave Cooking.

Raw animal foods cooked in a microwave oven shall be:

(A) Rotated or stirred throughout or midway during cooking to compensate for uneven distribution of heat;

(B) Covered to retain surface moisture;

(C) Heated to a temperature of at least 165 degrees F (74 degrees C) in all parts of the food; **P** and

(D) Allowed to stand covered for two (2) minutes after cooking to obtain temperature equilibrium.

3-401.13 Plant Food for Cooking for Hot Holding.

Plant foods that are cooked for hot holding shall be cooked to a temperature of 135 degrees F (57 degrees C). **Pf**

3-401.14 Non-Continuous Cooking of Raw Animal Foods.

Raw animal foods that are cooked using a non-continuous cooking process shall be:

(A) Subject to an initial heating process that is no longer than sixty (60) minutes in duration; **P**

(B) Immediately after initial heating, cooled according to the time and temperature parameters specified for cooked time /temperature control for safety food under 3-501.14(A); **P**

(C) After cooling, held frozen or cold, as specified for time/temperature control for safety food under 3-501.16(A)(2); **P**

(D) Prior to sale or service, cooked using a process that heats all parts of the food to a temperature and for a time as specified under section 3-401.11 (A) through (C) of the regulation; **P**

(E) Cooled according to the time and temperature parameters specified for cooked time/temperature control for safety food under 3-501.14(A) if not either hot held as specified under 3-501.16(A), served immediately, or held using time as a public health control as specified under 3-501.19 after complete cooking; **P** and

(F) Prepared and stored according to written procedures that:

(1) Have obtained prior approval from the Department; **Pf**

(2) Are maintained in the retail food establishment and are available to the Department upon request; **Pf**

(3) Describe how the requirements specified under (A) through (E) of this section are to be monitored and documented by the permit holder and the corrective actions to be taken if the requirements are not met; **Pf**

(4) Describe how the foods, after initial heating, but prior to complete cooking, are to be marked or otherwise identified as foods that must be cooked as specified under (D) of this section prior to being offered for sale or service; **Pf** and

(5) Describe how the foods, after initial heating but prior to cooking as specified under (D) of this section, are to be separated from ready-to-eat foods as specified under 3-302.11 (A). **Pf**

3-402 Freezing

3-402.11 Parasite Destruction.

(A) Except as specified in (B) of this section, before service or sale in ready-to-eat form, raw, raw-marinated, partially cooked, or marinated-partially cooked fish shall be:

(1) Frozen and stored at a temperature of -4 degrees F (-20 degrees C) or below for a minimum of one hundred sixty-eight (168) hours (seven (7) days) in a freezer; **P**

(2) Frozen at -31 degrees F (-35 degrees C) or below until solid and stored at -31 degrees F (-35 degrees C) or below for a minimum of fifteen (15) hours; **P** or

(3) Frozen -31 degrees F (-35 degrees C) or below until solid and stored at -4 degrees F (-20 degrees C) or below for a minimum of twenty-four (24) hours. **P**

(B) Paragraph (A) of this section does not apply to:

(1) Molluscan shellfish;

(2) A scallop product consisting only of the shucked adductor muscle;

(3) Tuna of the species *Thunnus alalunga*, *Thunnus albacares* (Yellowfin tuna), *Thunnus atlanticus*, *Thunnus maccoyii* (Bluefin tuna, Southern), *Thunnus obesus* (Bigeye tuna), or *Thunnus thynnus* (Bluefin tuna, Northern); or

(4) Aquacultured fish, such as salmon, that:

(a) If raised in open water, are raised in net-pens, or

(b) Are raised in land-based operations such as ponds or tanks, and

(c) Are fed formulated feed, such as pellets, that contains no live parasites infective to the aquacultured fish.

(5) Fish eggs that have been removed from the skein and rinsed.

3-402.12 Records, Creation and Retention.

(A) Except as specified in 3-402.11(B) and (B) of this section, if raw, raw-marinated, partially cooked, or marinated-partially cooked fish are served or sold in ready-to-eat form, the person in charge shall record the freezing temperature and time to which the fish are subjected and shall retain the records of the food establishment for ninety (90) calendar days beyond the time of service or sale of the fish. **Pf**

(B) If the fish are frozen by a supplier, a written agreement or statement from the supplier stipulating that the fish supplied are frozen to a temperature and for a time specified under 3-402.11 may substitute for the records specified under (A) of this section.

(C) If raw, raw-marinated, partially cooked, or marinated-partially cooked fish are served or sold in ready-to-eat form, and the fish are raised and fed as specified in 3-402.11(B)(4), a written agreement or statement from the supplier or aquaculturist stipulating that the fish were raised and fed as specified in 3-402.11(B)(4) shall be obtained by the person in charge and retained in the records of the food establishment for ninety (90) calendar days beyond the time of service or sale of the fish. **Pf**

3-403 Reheating

3-403.10 Preparation for Immediate Service.

Cooked and refrigerated food that is fully prepared for immediate service in response to an individual consumer order, such as a roast beef sandwich au jus, may be served at any temperature.

3-403.11 Reheating for Hot Holding.

(A) Except as specified under (B), (C) and (E) of this section, time/temperature control for safety food that is cooked, cooled, and reheated for hot holding shall be reheated so that all parts of the food reach a temperature of at least 165 degrees F (74 degrees C) for fifteen (15) seconds. **P**

(B) Except as specified under (C) of this section, time/temperature control for safety food reheated in a microwave oven for hot holding shall be reheated so that all parts of the food reach a temperature of at least 165 degrees F (74 degrees C) and the food is rotated or stirred, covered, and allowed to stand covered for two (2) minutes after reheating. **P**

(C) Ready-to-eat time/temperature control for safety food that has been commercially processed and packaged in a food processing plant that is inspected by the food regulatory authority that has jurisdiction over the plant shall be heated to a temperature of at least 135 degrees F (57 degrees C) for hot holding. **P**

(D) Reheating for hot holding as specified under (A) through (C) of this section shall be done rapidly and the time the food is between 41 degrees F (5 degrees C) and the temperatures specified under (A) through (C) of this section may not exceed two (2) hours. **P**

(E) Remaining unsliced portions of meat roasts that are cooked as specified under 3-401.11(B) may be reheated for hot holding using the oven parameters and minimum time and temperature conditions specified under 3-401.11(B).

3-404 Other Methods

3-404.11 Treating Juice.

Juice packaged in a retail food establishment shall be:

(A) Treated under a HACCP plan as specified in 8-201.14 to attain a 5-log reduction, which is equal to a 99.999 percent reduction, of the most resistant microorganism of public health significance; **P** or

(B) Labeled, if not treated to yield a 5-log reduction of the most resistant microorganism of public health significance, as specified in 21 CFR 101.17(g), *Food Labeling, Warning, Notice, and Safe Handling Statements*, juices that have not been specifically processed to prevent, reduce, or eliminate the presence of pathogens with the following, "WARNING: This product has not been pasteurized and, therefore, may contain harmful bacteria that can cause serious illness in children, the elderly, and persons with weakened immune systems." **PF**

3-5 LIMITATION OF GROWTH OF ORGANISMS OF PUBLIC HEALTH CONCERN

3-501 Temperature and Time Control

3-501.11 Frozen Food.

Stored frozen foods shall be maintained frozen.

3-501.12 Time/Temperature Control for Safety, Slacking.

Frozen time/temperature control for safety food that is slacked to moderate the temperature shall be held:

(A) Under refrigeration that maintains the food temperature at 41 degrees F (5 degrees C) or less; or

(B) At any temperature if the food remains frozen.

3-501.13 Thawing.

Except as specified in (D) of this section, time/temperature control for safety food shall be thawed:

(A) Under refrigeration that maintains the food temperature at 41 degrees F (5 degrees C) or less; or

(B) Completely submerged under cold running water:

(1) At a water temperature of 70 degrees F (21 degrees C) or below,

(2) With sufficient water velocity to agitate and float off loose particles in an overflow, and

(3) For a period of time that does not allow thawed portions of ready-to-eat food to rise above 41 degrees F (5 degrees C), or

(4) For a period of time that does not allow thawed portions of a raw animal food requiring cooking as specified under 3-401.11(A) or (B) to be above 41 degrees F (5 degrees C) for more than four (4) hours including:

(a) The time the food is exposed to the running water and the time needed for preparation for cooking, or

(b) The time it takes under refrigeration to lower the food temperature to 41 degrees F (5 degrees C);

(C) As part of a cooking process if the food that is frozen is:

(1) Cooked as specified under 3-401.11(A) or (B) or 3-401.12 or

(2) Thawed in a microwave oven and immediately transferred to conventional cooking equipment with no interruption in the process; or

(D) Using any procedure if a portion of frozen ready-to-eat food is thawed and prepared for immediate service in response to an individual consumer's order.

(E) Reduced oxygen packaged fish that bears a label indicating that it is to be kept frozen until time of use shall be removed from the reduced oxygen environment:

- (1) Prior to its thawing under refrigeration as specified in (A) of this section; or
- (2) Prior to or immediately upon completion of its thawing using procedures specified in (B) of this section.

3-501.14 Cooling.

(A) Cooked time/temperature control for safety food shall be cooled:

- (1) Within two (2) hours from 135 degrees F (57 degrees C) to 70 degrees F (21 degrees C); **P** and
- (2) Within a total of six (6) hours from 135 degrees F (57 degrees C) to 41 degrees F (5 degrees C) or less. **P**

(B) Time/temperature control for safety food shall be cooled within four (4) hours to 41 degrees F (5 degrees C) or less if prepared from ingredients at ambient temperature, such as reconstituted foods and canned tuna. **P**

(C) Except as specified under (D) of this section, a time/temperature control for safety food received in compliance with laws allowing a temperature above 41 degrees F (5 degrees C) during shipment from the supplier as specified in 3-202.11(B) shall be cooled within 4 hours to 41 degrees F (5 degrees C) or less; **P**

(D) Raw eggs shall be received as specified under 3-202.11(C) and immediately placed in refrigerated equipment that maintains an ambient air temperature of 45 degrees F (7 degrees C) or less. **P**

3-501.15 Cooling Methods.

(A) Cooling shall be accomplished in accordance with the time and temperature criteria specified under 3-501.14 by using one or more of the following methods based on the type of food being cooled:

- (1) Placing the food in shallow pans; **Pf**
- (2) Separating the food into smaller or thinner portions; **Pf**
- (3) Using rapid cooling equipment; **Pf**
- (4) Stirring the food in a container placed in an ice water bath; **Pf**
- (5) Using containers that facilitate heat transfer; **Pf**
- (6) Adding ice as an ingredient; or **Pf**
- (7) Other effective methods. **Pf**

(B) When placed in cooling or cold holding equipment, food containers in which food is being cooled shall be:

- (1) Arranged in the equipment to provide maximum heat transfer through the container walls; and
- (2) Loosely covered or uncovered if protected from overhead contamination as specified in 3-305.11(A)(2) during the cooling period to facilitate heat transfer from the surface of the food.

3-501.16 Time/Temperature Control for Safety Food, Hot and Cold Holding.

(A) Except during preparation, cooking, or cooling, or when time is used as the public health control as specified under 3-501.19, and except as specified under (B) and in (C) of this section, time/temperature control for safety food shall be maintained:

- (1) At 135 degrees F (57 degrees C) or above, except that roasts cooked to a temperature and for a time specified in 3-401.11(B) or reheated as specified in 3-403.11(E) may be held at a temperature of 130 degrees F (54 degrees C) or above; **P** or
- (2) At 41 degrees F (5 degrees C) or less. **P**

(B) Eggs that have not been treated to destroy all viable *Salmonellae* shall be stored in refrigerated equipment that maintains an ambient air temperature of 45 degrees F (7 degrees C) or less. **P**

(C) Time/temperature control for safety food in a homogenous liquid form may be maintained outside of the temperature control requirements, as specified under (A) of this section, while contained within specially designed equipment that complies with the design and construction requirements as specified under 4-204.13(E).

3-501.17 Ready to Eat, Time/Temperature Control for Safety Food, Date Marking.

(A) Except when packaging food using a reduced oxygen packaging method as specified under 3-502.12 and except as specified in (E) and (F) of this section, refrigerated, ready-to-eat, time/temperature control for safety food prepared and held in a retail food establishment for more than twenty-four (24) hours shall be clearly marked to indicate the date or day by which the food shall be consumed on the premises, sold, or discarded when held at a temperature of 41 degrees F (5 degrees C) or less for a maximum of seven (7) days. The day of preparation shall be counted as Day One (1).**Pf**

(B) Except as specified in (E) through (G) of this section, refrigerated, ready-to-eat, time/temperature control for safety food prepared and packaged by a food processing plant shall be clearly marked, at the time the original container is opened in a retail food establishment and if the food is held for more than twenty-four (24) hours, to indicate the date or day by which the food shall be consumed on the premises, sold, or discarded, based on the temperature and time combinations specified in (A) of this section and: **Pf**

(1) The day the original container is opened in the retail food establishment shall be counted as Day One (1);**Pf** and

(2) The day or date marked by the retail food establishment may not exceed a manufacturer's use-by date if the manufacturer determined the use-by date based on food safety. **Pf**

(C) A refrigerated, ready-to-eat, time/temperature control for safety food ingredient or a portion of a refrigerated, ready-to-eat, time/temperature control for safety food that is subsequently combined with additional ingredients or portions of food shall retain the date marking of the earliest-prepared or first-prepared ingredient. **Pf**

(D) A date marking system that meets the criteria stated in (A) and (B) of this section may include:

(1) Using a method approved by the Department for refrigerated, ready-to-eat time/temperature control for safety food that is frequently rewrapped, such as lunchmeat or a roast, or for which date marking is impractical, such as soft serve mix or milk in a dispensing machine;

(2) Marking the date or day of preparation with a procedure to discard the food on or before the last date or day by which the food must be consumed on the premises, sold, or discarded as specified under (A) of this section;

(3) Marking the date or day the original container is opened in a retail food establishment with a procedure to discard the food on or before the last date or day by which the food must be consumed on the premises, sold, or discarded as specified under (B) of this section; or

(4) Using calendar dates, days of the week, color-coded marks, or other effective marking methods, provided that the marking system is disclosed to the Department upon request.

(E) Paragraphs (A) and (B) of this section do not apply to individual meal portions served or repackaged for sale from a bulk container upon a consumer's request.

(F) Paragraphs (A) and (B) of this section do not apply to shellstock.

(G) Paragraph (B) of this section does not apply to the following foods prepared and packaged by a food processing plant inspected by the appropriate regulatory authority:

(1) Deli salads, such as ham salad, seafood salad, chicken salad, egg salad, pasta salad, potato salad, and macaroni salad, manufactured in accordance with 21 CFR 110, *Current Good Manufacturing Practice in Manufacturing, Packing, or Holding Human Food*;

(2) Hard cheeses containing not more than thirty- nine (39) percent moisture as defined in 21 CFR 133, *Cheeses and Related Cheese Products*, such as cheddar, gruyere, parmesan and reggiano, and romano;

(3) Semi-soft cheeses containing more than thirty-nine (39) percent moisture, but not more than fifty (50) percent moisture, as defined in 21 CFR 133, *Cheeses and Related Cheese Products*, such as blue, edam, gorgonzola, gouda, and monterey jack;

(4) Cultured dairy products as defined in 21 CFR 131, *Milk and Cream*, such as yogurt, sour cream, and buttermilk;

(5) Preserved fish products, such as pickled herring and dried or salted cod, and other acidified fish products defined in 21 CFR 114, *Acidified Foods*;

(6) Shelf stable, dry fermented sausages, such as pepperoni and Genoa; and

(7) Shelf stable salt-cured products such as prosciutto and Parma (ham).

3-501.18 Ready-to-Eat, Time/Temperature Control for Safety Food, Disposition.

A food specified in 3-501.17(A) or (B) shall be discarded if it:

(A) Exceeds the temperature and time combination specified in 3-501.17(A), except time that the product is frozen; **P**

(B) Is in a container or package that does not bear a date or day; **P** or

(C) Is appropriately marked with a date or day that exceeds a temperature and time combination as specified in 3-501.17(A).**P**

3-501.19 Time as a Public Health Control Measure.

(A) Except as specified under (D) of this section, if time without temperature control is used as the public health control for a working supply of time/temperature control for safety food before cooking, or for ready-to-eat time/temperature control for safety food that is displayed or held for sale or service:

(1) Written procedures shall be prepared in advance, maintained in the retail food establishment and made available to the Department upon request that specify: **Pf**

(a) Methods of compliance with (B)(1) through (4) or (C)(1) through (5) of this section; **Pf** and

(b) Methods of compliance with 3-501.14 for food that is prepared, cooked, and refrigerated before time is used as a public health control. **Pf**

(B) If time without temperature control is used as the public health control up to a maximum of four (4) hours:

(1) The food shall have an initial temperature of 41 degrees F (5 degrees C) or less when removed from cold holding temperature control, or 135 degrees F (57 degrees C) or greater when removed from hot holding temperature control; **P**

(2) The food shall be marked or otherwise identified to indicate the time that is four (4) hours past the point in time when the food is removed from temperature control; **Pf**

(3) The food shall be cooked and served, served at any temperature if ready-to-eat, or discarded, within four (4) hours from the point in time when the food is removed from temperature control; **P** and

(4) The food in unmarked containers or packages, or marked to exceed a four (4) hour limit shall be discarded. **P**

(C) If time without temperature control is used as the public health control up to a maximum of six (6) hours:

(1) The food shall have an initial temperature of 41 degrees F (5 degrees C) or less when removed from temperature control and the food temperature may not exceed 70 degrees F (21 degrees C) within a maximum time period of six (6) hours; **P**

(2) The food shall be monitored to ensure the warmest portion of the food does not exceed 70 degrees F (21 degrees C) during the six (6) hour period, unless an ambient air temperature is maintained that ensures the food does not exceed 70 degrees F (21 degrees C) during the six (6) hour holding period;**Pf**

(3) The food shall be marked or otherwise identified to indicate: **Pf**

(a) The time when the food is removed from 41 degrees F (5 degrees C) or less cold holding temperature control, **Pf** and

(b) The time that is six (6) hours past the point in time when the food is removed from cold holding temperature control; **Pf**

(4) The food shall be:

(a) Discarded if the temperature of the food exceeds 70 degrees F (21 degrees C),**P** or

(b) Cooked and served, served at any temperature if ready-to-eat, or discarded within a maximum of six (6) hours from the point in time when the food is removed from 41 degrees F (5 degrees C) or less cold holding temperature control; **P** and

(5) The food in unmarked containers or packages, or marked with a time that exceeds the six (6) hour limit shall be discarded. **P**

(D) A retail food establishment that serves a highly susceptible population may not use time as specified under (A), (B), or (C) of this section as the public health control for raw eggs.

3-502 Specialized Processing Methods

3-502.11 Special Processes Requiring a Variance.

A retail food establishment shall obtain a variance from the Department as specified in 8-103.10 and under 8-103.11 before: **Pf**

(A) Smoking food as a method of food preservation rather than as a method of flavor enhancement;**Pf**

(B) Curing food; **Pf**

(C) Using food additives or adding components such as vinegar: **Pf**

(1) As a method of food preservation rather than as a method of flavor enhancement, **Pf** or

(2) To render a food so that it is not a time/temperature control of safety food; **Pf**

(D) Packaging time/temperature control for safety food using a reduced oxygen packaging method except where the growth of and toxin formation by *Clostridium botulinum* and the growth of *Listeria monocytogenes* are controlled as specified under 3-502.12; **Pf**

(E) Custom processing animals that are for personal use as food and not for sale or service in a food establishment; **Pf**

(F) Preparing food by another method that is determined by the Department to require a variance; **Pf**

(G) Sprouting seeds or beans; **Pf** or

(H) Using additives or acidification when the process is for flavor enhancement only. Retail food establishments using additives or acidification for flavor enhancement only shall provide a written statement, in lieu of a HACCP plan, which shall describe foods prepared and essential safety measures implemented.

3-502.12 Reduced Oxygen Packaging Without a Variance, Criteria.

(A) Except for a retail food establishment that obtains a variance as specified under 3-502.11, a retail food establishment that packages time/temperature control for safety food using a reduced oxygen packaging method shall control the growth and toxin formation of *Clostridium botulinum* and the growth of *Listeria monocytogenes*. **P**

(B) Except as specified under (F) of this section, a retail food establishment that packages time/temperature control for safety food using a reduced oxygen packaging method shall implement a HACCP plan that contains the information specified under 8-201.14(C) and (D) and that: **Pf**

(1) Identifies the food to be packaged; **Pf**

(2) Except as specified under (C) through (E) of this section, requires that the packaged food shall be maintained at 41 degrees F (5 degrees C) or less and meet at least one of the following criteria: **Pf**

(a) Has an A_w of 0.91 or less, **Pf**

(b) Has a pH of 4.6 or less, **Pf**

- (c) Is a meat or poultry product cured at a food processing plant regulated by the USDA using substances specified in 9 CFR 424.21, *Use of Food Ingredients and Sources of Radiation*, and is received in an intact package, **Pf** or
 - (d) Is a food with a high level of competing organisms such as raw meat, raw poultry, or raw vegetables; **Pf**
 - (3) Describes how the package shall be prominently and conspicuously labeled on the principal display panel in bold type on a contrasting background, with instructions to: **Pf**
 - (a) Maintain the food at 41 degrees F (5 degrees C) or below, **Pf** and
 - (b) Discard the food if within thirty (30) calendar days of its packaging it is not served for on-premises consumption, or consumed if served or sold for off-premises consumption; **Pf**
 - (4) Limits the refrigerated shelf life to no more than thirty (30) calendar days from packaging to consumption, except the time the product is maintained frozen, or the original manufacturer's "sell by" or "use by" date, whichever occurs first; **P**
 - (5) Includes operational procedures that:
 - (a) Prohibit contacting ready-to-eat food with bare hands as specified under 3-301.11(B),**Pf**
 - (b) Identify a designated work area and the method by which: **Pf**
 - (i) Physical barriers or methods of separation of raw foods and ready-to-eat foods minimize cross contamination, **Pf** and
 - (ii) Access to the processing equipment is limited to responsible trained personnel familiar with the potential hazards of the operation, **Pf** and
 - (c) Delineate cleaning and sanitization procedures for food-contact surfaces; **Pf** and
 - (6) Describes the training program that ensures that the individual responsible for the reduced oxygen packaging operation understands the: **Pf**
 - (a) Concepts required for a safe operation, **Pf**
 - (b) Equipment and facilities, **Pf** and
 - (c) Procedures specified under (B)(5) of this section and 8-201.14 (C) and (D).**Pf**
 - (7) Is provided to the Department prior to implementation as specified under 8-201.13 (B).
- (C) Except for fish that is frozen before, during, and after packaging and bears a label indicating that it is to be kept frozen until time of use, a retail food establishment may not package fish using a reduced oxygen packaging method. **P**
- (D) Except as specified under (C) and (F) of this section, a retail food establishment that packages time/temperature control for safety food using a cook-chill or sous vide process shall:
- (1) Provide to the Department prior to implementation a HACCP plan that contains the information as specified under 8-201.14 (C) and (D); **Pf**
 - (2) Ensure the food is:
 - (a) Prepared and consumed on the premises, or prepared and consumed off the premises but within the same business entity with no distribution or sale of the packaged product to another business entity or the consumer, **Pf**
 - (b) Cooked to heat all parts of the food to a temperature and for a time as specified under 3-401.11 (A),(B), and (C),**P**
 - (c) Protected from contamination before and after cooking as specified under 3-3 and 3-4,**P**
 - (d) Placed in a package with an oxygen barrier and sealed before cooking or placed in a package and sealed immediately after cooking and before reaching a temperature below 135 degrees F (57 degrees C),**P**
 - (e) Cooled to 41 degrees F (5 degrees C) in the sealed package or bag as specified under 3-501.14 and: **P**
 - (i) Cooled to 34 degrees F (1 degrees C) within forty-eight (48) hours of reaching 41 degrees F (5 degrees C) and held at that temperature until consumed or discarded within thirty (30) days after the date of packaging; **P**

- (ii) Held at 41 degrees F (5 degrees C) or less for no more than seven (7) days, at which time the food must be consumed or discarded; **P** or
- (iii) Held frozen with no shelf life restriction while frozen until consumed or used. **P**
- (f) Held in a refrigeration unit that is equipped with an electronic system that continuously monitors time and temperature and is visually examined for proper operation twice daily, **Pf**
- (g) If transported off-site to a satellite location of the same business entity, equipped with verifiable electronic monitoring devices to ensure that times and temperatures are monitored during transportation, **Pf** and
- (h) Labeled with the product name and the date packaged; **Pf** and
- (3) Maintain the records required to confirm that cooling and cold holding refrigeration time/temperature parameters are required as part of the HACCP plan and:
 - (a) Make such records available to the Department upon request **Pf** and
 - (b) Hold such records for at least six (6) months; **Pf** and
- (4) Implement written operational procedures as specified under (B)(5) of this section and a training program as specified under (B)(6) of this section. **Pf**
- (E) Except as specified under (F) of this section, a retail food establishment that packages cheese using a reduced oxygen packaging method shall:
 - (1) Limit the cheeses packaged to those that are commercially manufactured in a food processing plant with no ingredients added in the retail food establishment and that meet the Standards of Identity as specified in 21 CFR 133.150, *Hard Cheeses*, 21 CFR 133.169, *Pasteurized Process Cheese* or 21 CFR 133.187, *Semisoft Cheeses*; **P**
 - (2) Have a HACCP plan that contains the information specified under 8–201.14 (C) and (D) and as specified under (B)(1), (B)(3)(a), (B)(5), and (B)(6) of this section; **Pf**
 - (3) Labels the package on the principal display panel with a “use by” date that does not exceed thirty (30) days from its packaging or the original manufacturer’s “sell by” or “use by” date, whichever occurs first; **Pf** and
 - (4) Discards the reduced oxygen packaged cheese if it is not sold for off-premises consumption or consumed within 30 calendar days of its packaging. **Pf**
- (F) A HACCP plan is not required when a retail food establishment uses a reduced oxygen packaging method to package time/temperature control for safety food that is always:
 - (1) Labeled with the production time and date,
 - (2) Held at 41 degrees F (5 degrees C) or less during refrigerated storage, and
 - (3) Removed from its package in the retail food establishment within forty-eight (48) hours after packaging.

3–6 FOOD IDENTITY, PRESENTATION, AND CONSUMER ADVISORY

3–601 Accurate Representation

3–601.11 Standards of Identity.

Packaged food shall comply with standard of identity requirements in 21 CFR 131–169 and 9 CFR 319, *Definitions and Standards of Identity or Composition*, and the general requirements in 21 CFR 130, *Food Standards: General* and 9 CFR 319 Subpart A, *General*.

3–601.12 Honestly Presented.

(A) Food shall be offered for human consumption in a way that does not mislead or misinform the consumer.

(B) Food or color additives, colored overwraps, or lights shall not be used to misrepresent the true appearance, color, or quality of a food.

3–602 Labeling

3–602.11 Food Labels.

(A) Food packaged in a retail food establishment shall be labeled as specified in law.

(B) Label information shall include:

(1) The common name of the food or, absent a common name, an adequately descriptive identity statement;

(2) The name and place of business of the manufacturer, packer, or distributor; and

(3) The name of the food source for each major food allergen contained in the food or a disclaimer that any major food allergen may be contained in the food.

(C) Bulk food that is available for consumer self-dispensing shall be prominently labeled with the following information in plain view of the consumer:

(1) The manufacturer's or processor's label that was provided with the food or

(2) A card, sign, or other method of notification that includes the information specified under Subparagraphs (B)(1) - (3) of this section.

(D) Bulk, unpackaged foods such as bakery products and unpackaged foods that are portioned to consumer specification need not be labeled if:

(1) A health, nutrient content, or other claim is not made;

(2) There are no state or local laws requiring labeling; and

(3) The food is manufactured or prepared on the premises of the retail food establishment or at another retail food establishment or a food processing plant that is owned by the same person and is regulated by the food regulatory agency that has jurisdiction.

3-603 Consumer Advisory

3-603.11 Consumption of Animal Foods that are Raw, Undercooked, or Not Otherwise Processed to Eliminate Pathogens.

(A) Except as specified in 3-401.11(C), 3-401.11(D)(4), and 3-801.11(C), if an animal food, such as beef, eggs, fish, lamb, pork, poultry, or shellfish, is served or sold raw, undercooked, or without otherwise being processed to eliminate pathogens, either in ready-to-eat form or as an ingredient in another ready-to-eat food, the permit holder shall inform consumers of the significantly increased risk of consuming such foods by way of a disclosure and reminder as specified in (B) and (C) of this section using brochures, deli case or menu advisories, label statements, table tents, placards, or other effective written means. **Pf**

(B) Disclosure shall include:

(1) A description of the animal-derived foods, such as "oysters on the half shell (raw oysters)," "raw-egg Caesar salad," and "hamburgers (can be cooked to order)"; **Pf** or

(2) Identification of the animal-derived foods by asterisking them to a footnote that states that the items are served raw, or undercooked, or contain (or may contain) raw or undercooked ingredients. **Pf**

(C) Reminder shall include asterisking the animal-derived foods requiring disclosure to a footnote that states:

(1) Regarding the safety of these items, written information is available upon request; **Pf**

(2) Consuming raw or undercooked meats, poultry, seafood, shellfish, or eggs may increase your risk of foodborne illness; **Pf** or

(3) Consuming raw or undercooked meats, poultry, seafood, shellfish, or eggs may increase your risk of foodborne illness, especially if you have certain medical conditions. **Pf**

(D) Packaged raw milk may be sold in packaged form provided it is bottled pursuant to the requirements of R.61-34, *Raw Milk for Human Consumption*, and provided a disclosure and reminder placard that is located at the point of sale. **Pf**

3-7 CONTAMINATED FOOD

3-701 Disposition

3-701.11 Discarding or Reconditioning Unsafe, Adulterated, or Contaminated Food.

(A) A food that is unsafe, adulterated, or not honestly presented as specified under 3-101.11 shall be discarded or reconditioned according to an approved procedure. **P**

(B) Food that is not from an approved source as specified under 3-201.11 through 3-201.17 shall be discarded. **P**

(C) Ready-to-eat food that may have been contaminated by an employee who has been restricted or excluded as specified under 2–201.12 shall be discarded. **P**

(D) Food that is contaminated by food employees, consumers, or other persons through contact with their hands, bodily discharges, such as nasal or oral discharges, or other means shall be discarded. **P**

3–8 SPECIAL REQUIREMENTS FOR HIGHLY SUSCEPTIBLE POPULATIONS

3–801 Additional Safeguards

3–801.11 Pasteurized Foods, Prohibited Re-Service, and Prohibited Food.

In a retail food establishment that serves a highly susceptible population:

(A) The following criteria shall apply to juice:

(1) For the purposes of this paragraph only, children who are age nine (9) or less and receive food in a school, day care setting, or similar facility that provides custodial care are included as highly susceptible populations;

(2) Prepackaged juice or a prepackaged beverage containing juice, that bears a warning label as specified in 21 CFR, 101.17(g) *Food Labeling, Warning, Notice, and Safe Handling Statements*, juices that have not been specifically processed to prevent, reduce, or eliminate the presence of pathogens, or a packaged juice or beverage containing juice, that bears a warning label as specified under 3–404.11(B) may not be served or offered for sale; **P** and

(3) Unpackaged juice that is prepared on the premises for service or sale in a ready-to-eat form shall be processed under a HACCP plan that contains the information specified under 8–201.14(B) through (E) and as specified in 21 CFR Part 120, *Hazard Analysis and Critical Control Point (HACCP) Systems*, Subpart B, *Pathogen Reduction*, 120.24, *Process Controls*. **P**

(B) Pasteurized eggs or egg products shall be substituted for raw eggs in the preparation of: **P**

(1) Foods such as Caesar salad, hollandaise or Béarnaise sauce, mayonnaise, meringue, eggnog, ice cream, and egg-fortified beverages^P and

(2) Except as specified in (F) of this section, recipes in which more than one egg is broken and the eggs are combined; **P**

(C) The following foods may not be served or offered for sale in a ready-to-eat form: **P**

(1) Raw animal foods such as raw fish, raw-marinated fish, raw molluscan shellfish, and steak tartare, **P**

(2) A partially cooked animal food such as lightly cooked fish, rare meat, soft-cooked eggs that are made from raw eggs, and meringue; **P** and

(3) Raw seed sprouts. **P**

(D) Food employees may not contact ready-to-eat food as specified under 3–301.11(B). **P**

(E) Time only, as the public health control as specified under 3–501.19(D), may not be used for raw eggs. **P**

(F) Subparagraph (B)(2) of this section does not apply if:

(1) The raw eggs are combined immediately before cooking for one consumer's serving at a single meal, cooked as specified under 3–401.11(A)(1), and served immediately, such as an omelet, souffl, or scrambled eggs;

(2) The raw eggs are combined as an ingredient immediately before baking and the eggs are thoroughly cooked to a ready-to-eat form, such as a cake, muffin, or bread; or

(3) The preparation of the food is conducted under a HACCP plan that:

(a) Identifies the food to be prepared,

(b) Prohibits contacting ready-to-eat food with bare hands,

(c) Includes specifications and practices that ensure:

(i) *Salmonella* Enteritidis growth is controlled before and after cooking, and

(ii) *Salmonella* Enteritidis is destroyed by cooking the eggs according to the temperature and time specified in 3–401.11(A)(2),

- (d) Contains the information specified under 8-201.14(D) including procedures that:
 - (i) Control cross contamination of ready-to-eat food with raw eggs and
 - (ii) Delineate cleaning and sanitization procedures for food-contact surfaces, and
- (e) Describes the training program that ensures that the food employee responsible for the preparation of the food understands the procedures to be used.
- (G) Except as specified in (H) of this section, food may be re-served as specified under 3-306.14(B)(1) and (2).
- (H) Food may not be re-served under the following conditions:
 - (1) Any food served to patients or clients who are under contact precautions in medical isolation or quarantine or protective environment isolation may not be re-served to others outside.
 - (2) Packages of food from any patients, clients, or other consumers should not be re-served to persons in protective environment isolation.

Chapter 4 Equipment, Utensils, and Linens

4-1 MATERIALS FOR CONSTRUCTION AND REPAIR

4-101 Multiuse

4-101.11 Characteristics.

Materials that are used in the construction of utensils and food-contact surfaces of equipment may not allow the migration of deleterious substances or impart colors, odors, or tastes to food and, under normal use conditions, utensils and food-contact surfaces shall be: **P**

- (A) Safe; **P**
- (B) Durable, corrosion-resistant, and nonabsorbent;
- (C) Sufficient in weight and thickness to withstand repeated warewashing;
- (D) Finished to have a smooth, easily cleanable surface; and
- (E) Resistant to pitting, chipping, crazing, scratching, scoring, distortion, and decomposition.

4-101.12 Cast Iron, Use Limitation.

(A) Except as specified in (B) and (C) of this section, cast iron may not be used for utensils or food-contact surfaces of equipment.

(B) Cast iron may be used as a surface for cooking.

(C) Cast iron may be used in utensils for serving food if the utensils are used only as part of an uninterrupted process from cooking through service.

4-101.13 Lead, Use Limitation.

(A) Ceramic, china, crystal utensils, and decorative utensils, such as hand-painted ceramic or china, that are used in contact with food shall be lead-free or contain levels of lead not exceeding acceptable limits of the following utensil categories: **P**

Utensil Category	Ceramic Article Description	Maximum Lead mg/L
Beverage Mugs, Cups, Pitchers	Coffee Mugs	0.5
Large Hollowware (excluding pitchers)	Bowls greater than or equal to 1.1 Liter (1.16 Quart)	1.0
Small Hollowware (excluding cups & mugs)	Bowls less than 1.1 Liter (1.16 Quart)	2.0
Flat Tableware	Plates, Saucers	3.0

(B) Pewter alloys containing lead in excess of 0.05 percent shall not be used as a food-contact surface.**P**

(C) Solder and flux containing lead in excess of 0.2 percent shall not be used as a food-contact surface.

4-101.14 Copper, Use Limitation.

(A) Except as specified in (B) of this section, copper and copper alloys such as brass may not be used in contact with a food that has a pH below six (6.0) such as vinegar, fruit juice, or wine or for a fitting or tubing installed between a backflow prevention device and a carbonator. ^P

(B) Copper and copper alloys may be used in contact with beer brewing ingredients that have a pH below six (6.0) in the pre-fermentation and fermentation steps of a beer brewing operation such as a brewpub or microbrewery.

4-101.15 Galvanized Metal, Use Limitation.

Galvanized metal shall not be used for utensils or food-contact surfaces of equipment that are used in contact with acidic food. ^P

4-101.16 Sponges, Use Limitation.

Sponges may not be used in contact with cleaned and sanitized or in-use food-contact surfaces.

4-101.17 Wood, Use Limitations.

(A) Except as specified in (B), (C), (D), (E), and (F) of this section, wood and wood wicker may not be used as a food-contact surface.

(B) Hard maple or an equivalently hard, close-grained wood may be used for:

- (1) Cutting boards; cutting blocks; bakers' tables; and utensils such as rolling pins, doughnut dowels, salad bowls, and chopsticks; and
- (2) Wooden paddles used in confectionery operations for pressure scraping kettles when manually preparing confections at a temperature of 110 degrees C (230 degrees F) or above.
- (3) Bagel boards including a laminated hardwood may be acceptable if the food-contact surface is smooth and in good repair.

(C) Cedar planks intended for grilling fish, provided only for this purpose, and discarded after a single use.

(D) Whole, uncut, raw fruits and vegetables and nuts in the shell may be kept in the wood shipping containers in which they were received until the fruits, vegetables, or nuts are used.

(E) If the nature of the food requires removal of rinds, peels, husks, or shells before consumption, the whole, uncut, raw food may be kept in:

- (1) Untreated wood containers; or
- (2) Treated wood containers if the containers are treated with a preservative that meets the requirements specified in 21 CFR 178.3800, *Preservatives for Wood*.

(F) Wicker may be used only when suitably lined.

4-101.18 Nonstick Coating, Use Limitation

Multiuse kitchenware such as frying pans, griddles, sauce pans, cookie sheets, and waffle bakers that have a perfluorocarbon resin coating shall be used with nonscoring or nonscratching utensils and cleaning aids.

4-101.19 Nonfood-contact Surfaces.

Nonfood-contact surfaces of equipment that are exposed to splash, spillage, or other food soiling or that require frequent cleaning shall be constructed of a corrosion-resistant, nonabsorbent, smooth material.

4-102 Single-Service and Single-Use

4-102.11 Characteristics.

Materials that are used to make single-service and single-use articles:

(A) Shall not:

- (1) Allow the migration of deleterious substances^P or
- (2) Impart colors, odors, or tastes to food; and

(B) Shall be:

- (1) Safe^P and
- (2) Clean.

4-2 DESIGN AND CONSTRUCTION

4-201 Durability and Strength

4-201.11 Equipment and Utensils.

Equipment and utensils shall be designed and constructed to be durable and to retain their characteristic qualities under normal use conditions.

4-201.12 Food Temperature Measuring Devices.

Food temperature measuring devices may not have sensors or stems constructed of glass, except that thermometers with glass sensors or stems that are encased in a shatterproof coating such as candy thermometers may be used. ^P

4-202 Cleanability

4-202.11 Food-Contact Surfaces.

(A) Multiuse food-contact surfaces shall be:

- (1) Smooth; ^{Pf}
- (2) Free of breaks, open seams, cracks, chips, inclusions, pits, and similar imperfections ^{Pf}
- (3) Free of sharp internal angles, corners, and crevices; ^{Pf}
- (4) Finished to have smooth welds and joints; ^{Pf} and
- (5) Except as specified in (B) of this section, accessible for cleaning and inspection by one of the following methods:
 - (a) Without being disassembled, ^{Pf} or
 - (b) By disassembling without the use of tools, ^{Pf} or
 - (c) By easy disassembling with the use of handheld tools commonly available to maintenance and cleaning personnel such as screwdrivers, pliers, open-end wrenches, and Allen wrenches. ^{Pf}

(B) Subparagraph (A)(5) of this section does not apply to cooking oil storage tanks, distribution lines for cooking oils, or beverage syrup lines or tubes.

4-202.12 CIP Equipment.

(A) CIP equipment shall meet the characteristics specified under 4-202.11 and shall be designed and constructed so that:

- (1) Cleaning and sanitizing solutions circulate throughout a fixed system and contact all interior food-contact surfaces, ^{Pf} and
- (2) The system is self-draining or capable of being completely drained of cleaning and sanitizing solutions; and

(B) CIP equipment that is not designed to be disassembled for cleaning shall be designed with inspection access points to ensure that all interior food-contact surfaces throughout the fixed system are being effectively cleaned.

4-202.13 “V” Threads, Use Limitation.

Except for hot oil cooking or filtering equipment, “V” type threads may not be used on food-contact surfaces.

4-202.14 Hot Oil Filtering Equipment.

Hot oil filtering equipment shall meet the characteristics specified under 4-202.11 or 4-202.12 and shall be readily accessible for filter replacement and cleaning of the filter.

4-202.15 Can Openers.

Cutting or piercing parts of can openers shall be readily removable for cleaning and for replacement.

4-202.16 Nonfood-Contact Surfaces.

Nonfood-contact surfaces shall be free of unnecessary ledges, projections, and crevices, and designed and constructed to allow easy cleaning and to facilitate maintenance.

4-202.17 Kick Plates, Removable.

Kick plates shall be designed so that the areas behind them are accessible for inspection and cleaning by being:

(A) Removable by one of the methods specified under 4-202.11(A)(5) or capable of being rotated open and

(B) Removable or capable of being rotated open without unlocking equipment doors.

4-202.18 Ventilation Hood Systems, Filters.

Filters and other grease-extracting equipment shall be designed to be readily removable for cleaning and replacement if not designed to be cleaned in place.

4-203 Accuracy

4-203.11 Temperature Measuring Devices, Food.

(A) Food temperature measuring devices that are scaled only in Celsius or dually scaled in Celsius and Fahrenheit shall be accurate to plus or minus one (1) degrees C in the intended range of use. **Pf**

(B) Food temperature measuring devices that are scaled only in Fahrenheit shall be accurate to plus or minus two (2) degrees F in the intended range of use. **Pf**

4-203.12 Temperature Measuring Devices, Ambient Air and Water.

(A) Ambient air and water temperature measuring devices that are scaled in Celsius or dually scaled in Celsius and Fahrenheit shall be designed to be easily readable and accurate to plus or minus one point five (1.5) degrees C in the intended range of use. **Pf**

(B) Ambient air and water temperature measuring devices that are scaled only in Fahrenheit shall be accurate to plus or minus three (3) degrees F in the intended range of use. **Pf**

4-203.13 Pressure Measuring Devices, Mechanical Warewashing Equipment.

Pressure measuring devices that display the pressures in the water supply line for the fresh hot water sanitizing rinse shall have increments of one (1) pound per square inch (7 kilopascals) or smaller and shall be accurate to plus or minus two (2) pounds per square inch (plus or minus 14 kilopascals) in the range indicated on the manufacturer's data plate.

4-204 Functionality

4-204.11 Ventilation Hood Systems, Drip Prevention.

Exhaust ventilation hood systems in food preparation and warewashing areas including components such as hoods, fans, filters, and ducting shall be of commercial type and designed to prevent grease or condensation from draining or dripping onto food, equipment, utensils, linens, and single-service and single-use articles.

4-204.12 Equipment Openings, Closures, and Deflectors.

(A) A cover or lid for equipment shall overlap the opening and be sloped to drain.

(B) An opening located within the top of a unit of equipment that is designed for use with a cover or lid shall be flanged upward at least five (5) millimeters (two-tenths of an inch).

(C) Except as specified under (D) of this section, fixed piping, temperature measuring devices, rotary shafts, and other parts extending into equipment shall be provided with a watertight joint at the point where the item enters the equipment.

(D) If a watertight joint is not provided:

(1) The piping, temperature measuring devices, rotary shafts, and other parts extending through the openings shall be equipped with an apron designed to deflect condensation, drips, and dust from openings into the food; and

(2) The opening shall be flanged as specified under (B) of this section.

4-204.13 Dispensing Equipment, Protection of Equipment and Food.

In equipment that dispenses or vends liquid food or ice in unpackaged form:

(A) The delivery tube, chute, orifice, and splash surfaces directly above the container receiving the food shall be designed in a manner, such as with barriers, baffles, or drip aprons, so that drips from condensation and splash are diverted from the opening of the container receiving the food;

(B) The delivery tube, chute, and orifice shall be protected from manual contact such as by being recessed;

(C) The delivery tube or chute and orifice of equipment used to vend liquid food or ice in unpackaged form to self-service consumers shall be designed so that the delivery tube or chute and orifice are protected from dust, insects, rodents, and other contamination by a self-closing door if the equipment is:

(1) Located in an outside area that does not otherwise afford the protection of an enclosure against the rain, windblown debris, insects, rodents, and other contaminants that are present in the environment or

(2) Available for self-service during hours when it is not under the full-time supervision of a food employee; and

(D) The dispensing equipment actuating lever or mechanism and filling device of consumer self-service beverage dispensing equipment shall be designed to prevent contact with the lip-contact surface of glasses or cups that are refilled.

(E) Dispensing equipment in which time/temperature control for safety food in a homogenous liquid form is maintained outside of the temperature control requirements as specified under 3-501.16(A) shall:

(1) Be specifically designed and equipped to maintain the commercial sterility of aseptically packaged food in a homogenous liquid form for a specified duration from the time of opening the packaging within the equipment; **P** and

(2) Conform to the requirements for this equipment as specified in NSF/ANSI 18-2006, *Manual Food and Beverage Dispensing Equipment*. **P**

4-204.15 Bearings and Gear Boxes, Leakproof.

Equipment containing bearing and gears that require lubricants shall be designed and constructed so that the lubricant cannot leak, drip, or be forced into food or onto food-contact surfaces.

4-204.16 Beverage Tubing, Separation.

Except for cold plates that are constructed integrally with an ice storage bin, beverage tubing and cold-plate beverage cooling devices may not be installed in contact with stored ice.

4-204.17 Ice Units, Separation of Drains.

Liquid waste drain lines shall not pass through an ice machine or ice storage bin.

4-204.18 Condenser Unit, Separation.

If a condenser unit is an integral component of equipment, the condenser unit shall be separated from the food and food storage space by a dustproof barrier.

4-204.110 Molluscan Shellfish Tanks.

Molluscan shellfish life support system display tanks may not be used to store or display shellfish that are offered for human consumption and shall be conspicuously marked so that it is obvious to the consumer that the shellfish are for display only. **P**

4-204.112 Temperature Measuring Devices.

(A) In a mechanically refrigerated or hot food storage unit, the sensor of a temperature measuring device shall be located to measure the air temperature in the warmest part of a mechanically refrigerated unit and in the coolest part of a hot food storage unit.

(B) Except as specified in (C) of this section, cold or hot holding equipment used for time/temperature control safety food shall be designed to include and shall be equipped with at least one integral or permanently affixed temperature measuring device that is located to allow easy viewing of the device's temperature display.

(C) Paragraph (B) of this section does not apply to equipment for which the placement of a temperature measuring device is not a practical means for measuring the ambient air surrounding the food because of the design, type, and use of the equipment, such as calorod units, heat lamps, cold plates, bainmaries, steam tables, insulated food transport containers, and salad bars.

(D) Temperature measuring devices shall be designed to be easily readable.

(E) Food temperature measuring devices and water temperature measuring devices on warewashing machines shall have a numerical scale or digital readout in increments no greater than 2 degrees F (1 degree C) in the intended range of use. **Pf**

4-204.113 Warewashing Machine, Data Plate, Operating Specifications.

A warewashing machine shall be provided with an easily accessible and readable data plate affixed to the machine by the manufacturer that indicates the machine's design and operation specifications including the:

- (A) Temperature required for washing, rinsing, and sanitizing;
- (B) Pressure required for the fresh water sanitizing rinse unless the machine is designed to use only a pumped sanitizing rinse; and
- (C) Conveyor speed for conveyor machines or cycle time for stationary rack machines.

4-204.114 Warewashing Machines, Internal Curtains.

Warewashing machine wash and rinse tanks shall be equipped with baffles, curtains, or other means to minimize internal cross contamination of the solutions in wash and rinse tanks.

4-204.115 Warewashing Machines, Temperature Measuring Devices.

A warewashing machine shall be equipped with a temperature measuring device that indicates the temperature of the water:

- (A) In each wash and rinse tank; **Pf** and
- (B) As the water enters the hot water sanitizing final rinse manifold or in the chemical sanitizing solution tank. **Pf**

4-204.116 Manual Warewashing Equipment, Heaters and Baskets.

If hot water is used for sanitization in manual warewashing operations, the sanitizing compartment of the sink shall be:

- (A) Designed with an integral heating device, equipped with an integral thermometer, that is capable of maintaining water at a temperature not less than 171 degrees F (77 degrees C); **Pf** and
- (B) Provided with a rack or basket to allow complete immersion of equipment and utensils into the hot water. **Pf**

4-204.117 Warewashing Machines, Automatic Dispensing of Detergents and Sanitizers.

A warewashing machine shall be equipped to:

- (A) Automatically dispense detergents and sanitizers; **Pf** and
- (B) Incorporate a visual means to verify that detergents and sanitizers are delivered or a visual or audible alarm to signal if the detergents and sanitizers are not delivered to the respective washing and sanitizing cycles. **Pf**

4-204.118 Warewashing Machines, Flow Pressure Device.

(A) Warewashing machines that provide a fresh hot water sanitizing rinse shall be equipped with a pressure gauge or similar device such as a transducer that measures and displays the water pressure in the supply line immediately before entering the warewashing machine and

(B) If the flow pressure measuring device is upstream of the fresh hot water sanitizing rinse control valve, the device shall be mounted in a 6.4 millimeter or one-fourth inch Iron Pipe Size (IPS) valve.

(C) Paragraphs (A) and (B) of this section do not apply to a machine that uses only a pumped or recirculated sanitizing rinse.

4-204.119 Warewashing Sinks and Drainboards, Self-Draining.

Sinks and drainboards of warewashing sinks and machines shall be self-draining.

4-204.120 Equipment Compartments, Drainage.

Equipment compartments that are subject to accumulation of moisture due to conditions such as condensation, food or beverage drip, or water from melting ice shall be sloped to an outlet that allows complete draining.

4-204.122 Case Lot Handling Apparatuses, Moveability.

Apparatuses, such as dollies, pallets, racks, and skids used to store and transport large quantities of packaged foods received from a supplier in a cased or overwrapped lot, shall be designed to be moved by hand or by conveniently available apparatuses such as hand trucks and forklifts.

4-205 Acceptability

4-205.10 Food Equipment, Certification, and Classification.

(A) Except as specified in (B) of this section, all equipment installed in a retail food establishment after the effective date of this regulation shall be certified or classified and listed to National Sanitation Foundation (NSF) / American National Standards Institute (ANSI) Commercial Food Equipment Standards, or Baking Industry Sanitation Standards Committee (BISSC), or other accredited ANSI food equipment sanitation certification recognized by the Department.

(B) Residential counter-top appliances, such as, but not limited to, coffee makers, a crockpot, toaster, toaster oven, microwave oven; and shelving, residential chest and upright freezers are exempt, but shall meet the requirements of 4-1 and 4-2.

4-3 NUMBERS AND CAPACITIES

4-301 Equipment

4-301.11 Cooling, Heating, and Holding Capacities.

Equipment for cooling and heating food and holding cold and hot food shall be sufficient in number and capacity to maintain food temperatures as specified under Chapter 3.^{Pf}

4-301.12 Manual Warewashing, Sink Compartment Requirements.

(A) Except as specified in (C) of this section, a sink with at least three (3) compartments shall be provided for manually washing, rinsing, and sanitizing equipment and utensils. ^{Pf}

(B) Sink compartments shall be large enough to accommodate immersion of the largest equipment and utensils. If equipment or utensils are too large for the warewashing sink, a warewashing machine or alternative equipment as specified in (C) of this section shall be used. ^{Pf}

(C) Alternative manual warewashing equipment may be used when there are special cleaning needs or constraints and its use is approved. Alternative manual warewashing equipment may include:

- (1) High-pressure detergent sprayers;
- (2) Low- or line-pressure spray detergent foamers;
- (3) Other task-specific cleaning equipment;
- (4) Brushes or other implements;
- (5) Two (2)-compartment sinks as specified under (D) and (E) of this section; or
- (6) Receptacles that substitute for the compartments of a multicompartment sink.

(D) Before a two (2) compartment sink is used:

- (1) The permit holder shall have its use approved and
- (2) The permit holder shall limit the number of kitchenware items cleaned and sanitized in the two (2) compartment sink, shall limit warewashing to batch operations for cleaning kitchenware such as between cutting one type of raw meat and another or cleanup at the end of a shift, and shall:
 - (a) Make up the cleaning and sanitizing solutions immediately before use and drain them immediately after use, and
 - (b) Use a detergent-sanitizer to sanitize and apply the detergent-sanitizer in accordance with the manufacturer's label instructions and as specified under 4-501.115, or
 - (c) Use a hot water sanitization immersion step as specified under 4-603.16(C).

(E) A two (2) compartment sink may not be used for warewashing operations where cleaning and sanitizing solutions are used for a continuous or intermittent flow of kitchenware or tableware in an ongoing warewashing process.

4-301.13 Drainboards.

Drainboards, utensil racks, or tables large enough to accommodate all soiled and cleaned items that may accumulate during hours of operation shall be provided for necessary utensil holding before cleaning and after sanitizing.

4-301.14 Ventilation Hood Systems, Adequacy.

Ventilation hood systems and devices shall be sufficient in number and capacity to prevent grease or condensation from collecting on walls and ceilings.

4-301.15 Clothes Washers and Dryers.

(A) Except as specified in (B) of this section, if work clothes or linens are laundered on the premises, a mechanical clothes washer and dryer shall be provided and used.

(B) If on-premises laundering is limited to wiping cloths intended to be used moist or wiping cloths are air-dried as specified under 4-901.12, a mechanical clothes washer and dryer need not be provided.

4-302 Utensils, Temperature Measuring Devices, and Testing Devices

4-302.11 Utensils, Consumer Self-Service.

A food dispensing utensil shall be available for each container displayed at a consumer self-service unit such as a buffet or salad bar. **Pf**

4-302.12 Food Temperature Measuring Devices.

(A) Food temperature measuring devices required for the immersion into food shall be provided and used to ensure the attainment and maintenance of food temperatures as specified under Chapter 3. **Pf**

(B) A temperature measuring device with a suitable small diameter probe that is designed to measure the temperature of thin masses shall be provided and readily accessible to accurately measure the temperature in thin foods such as meat patties and fish filets. **Pf**

4-302.13 Temperature Measuring Devices, Manual and Mechanical Warewashing.

(A) In manual warewashing operations, a temperature measuring device shall be provided and readily accessible for frequently measuring the washing and sanitizing temperatures. **Pf**

(B) In hot water mechanical warewashing operations, an irreversible registering temperature indicator shall be provided and readily accessible for measuring the utensil surface temperature. **Pf**

4-302.14 Sanitizing Solutions, Testing Devices.

A test kit or other device that accurately measures the concentration in MG/L of sanitizing solutions shall be provided. **Pf**

4-303 Cleaning Agents and Sanitizers

4-303.11 Cleaning Agents and Sanitizers, Availability.

(A) Cleaning agents that are used to clean equipment and utensils as specified under section 4-6 shall be provided and available for use during all hours of operation.

(B) Except for those that are generated on-site at the time of use, chemical sanitizers that are used to sanitize equipment and utensils as specified under section 4-7 shall be provided and available for use during all hours of operation.

4-4 LOCATION AND INSTALLATION

4-401 Location

4-401.11 Equipment, Clothes Washers and Dryers, and Storage Cabinets, Contamination Prevention.

(A) Except as specified in (B) of this section, equipment, a cabinet used for the storage of food, or a cabinet that is used to store cleaned and sanitized equipment, utensils, laundered linens, and single-service and single-use articles may not be located:

- (1) In locker rooms;
- (2) In toilet rooms;
- (3) In garbage rooms;
- (4) In mechanical rooms;

- (5) Under sewer lines that are not shielded to intercept potential drips;
- (6) Under leaking water lines including leaking automatic fire sprinkler heads or under lines on which water has condensed;
- (7) Under open stairwells; or
- (8) Under other sources of contamination.

(B) A storage cabinet used for linens or single-service or single-use articles may be stored in a locker room.

(C) If a mechanical clothes washer or dryer is provided, it shall be located so that the washer or dryer is protected from contamination and only where there is no exposed food; clean equipment, utensils, and linens; and unwrapped single-service and single-use articles.

4-402 Installation

4-402.11 Fixed Equipment, Spacing, or Sealing.

(A) Equipment that is fixed in place because it is not easily movable shall be installed so that it is:

- (1) Spaced to allow access for cleaning along the sides, behind, and above the equipment;
- (2) Spaced from adjoining equipment, walls, and ceilings a distance of not more than one (1) millimeter or one thirty-second inch; or
- (3) Sealed to adjoining equipment or walls, if the equipment is exposed to spillage or seepage.

(B) Counter-mounted equipment that is not easily movable shall be installed to allow cleaning of the equipment and areas underneath and around the equipment by being:

- (1) Sealed; or
- (2) Elevated on legs as specified under 4-402.12(D).

4-402.12 Fixed Equipment, Elevation, or Sealing.

(A) Except as specified in (B) and (C) of this section, floor-mounted equipment that is not easily movable shall be sealed to the floor or elevated on legs that provide at least a six (6) inches (15 centimeters), of clearance between the floor and the equipment.

(B) If no part of the floor under the floor-mounted equipment is more than six (6) inches (15 centimeters) from the point of cleaning access, the clearance space may be only four (4) inches (10 centimeters).

(C) This section does not apply to display shelving units, display refrigeration units, and display freezer units located in the consumer shopping areas of a retail food store, if the floor under the units is maintained clean.

(D) Except as specified in (E) of this section, counter-mounted equipment that is not easily movable shall be elevated on legs that provide at least a four (4) inch (10 centimeters) clearance between the table and the equipment.

(E) The clearance space between the table and counter-mounted equipment may be:

- (1) Three (3) inches (7.5 centimeters) if the horizontal distance of the table top under the equipment is no more than twenty (20) inches (50 centimeters) from the point of access for cleaning; or
- (2) Two (2) inches (5 centimeters) if the horizontal distance of the table top under the equipment is no more than three (3) inches (7.5 centimeters) from the point of access for cleaning.

4-5 MAINTENANCE AND OPERATION

4-501 Equipment

4-501.11 Good Repair and Proper Adjustment.

(A) Equipment shall be maintained in a state of repair and condition that meets the requirements specified under 4-1 and 4-2.

(B) Equipment components such as doors, seals, hinges, fasteners, and kick plates shall be kept intact, tight, and adjusted in accordance with manufacturer's specifications.

(C) Cutting or piercing parts of can openers shall be kept sharp to minimize the creation of metal fragments that can contaminate food when the container is opened.

4-501.12 Cutting Surfaces.

Surfaces such as cutting blocks and boards that are subject to scratching and scoring shall be resurfaced if they can no longer be effectively cleaned and sanitized or discarded if they are not capable of being resurfaced.

4-501.14 Warewashing Equipment, Cleaning Frequency.

A warewashing machine; the compartment(s) of sinks, basins, or other receptacles used for washing and rinsing equipment, utensils, raw foods, or laundering wiping cloths; and drainboards or other equipment as specified in 4-301.13 shall be cleaned:

(A) Before use;

(B) Throughout the day at a frequency necessary to prevent recontamination of equipment and utensils and to ensure that the equipment performs its intended function; and

(C) During use, at least once every twenty-four (24) hours.

4-501.15 Warewashing Machines, Manufacturers' Operating Instructions.

(A) A warewashing machine and its auxiliary components shall be operated in accordance with the machine's data plate and other manufacturer's instructions.

(B) A warewashing machine's conveyor speed or automatic cycle times shall be maintained accurately timed in accordance with manufacturer's specifications.

4-501.16 Warewashing Sinks and Food Preparation Sinks, Use Limitation.

(A) A warewashing sink may not be used for handwashing as specified under 2-301.15.

(B) If a warewashing sink is used to wash wiping cloths, wash produce, or thaw food, the sink shall be cleaned as specified under 4-501.14 before and after each time it is used to wash wiping cloths or wash produce or thaw food. Sinks used to wash or thaw food shall be sanitized as specified under 4-7 before and after using the sink to wash produce or thaw food.

4-501.17 Warewashing Equipment, Cleaning Agents.

When used for warewashing, the wash compartment of a sink, mechanical warewasher, or wash receptacle of alternative manual warewashing equipment as specified in 4-301.12(C) shall contain a wash solution of soap, detergent, acid cleaner, alkaline cleaner, degreaser, abrasive cleaner, or other cleaning agent according to the cleaning agent manufacturer's label instructions. ^{Pf}

4-501.18 Warewashing Equipment, Clean Solutions.

The wash, rinse, and sanitize solutions shall be maintained clean.

4-501.19 Manual Warewashing Equipment, Wash Solution Temperature.

The temperature of the wash solution in manual warewashing equipment shall be maintained at not less than 110 degrees F (43 degrees C) or the temperature as specified on the cleaning agent manufacturer's label instructions. ^{Pf}

4-501.110 Mechanical Warewashing Equipment, Wash Solution Temperature.

(A) The temperature of the wash solution in spray type warewashers that use hot water to sanitize shall not be less than:

(1) For a stationary rack, single temperature machine, 165 degrees F (74 degrees C);^{Pf}

(2) For a stationary rack, dual temperature machine, 150 degrees F (66 degrees C);^{Pf}

(3) For a single tank, conveyor, dual temperature machine, 160 degrees F (71 degrees C);^{Pf} or

(4) For a multitank, conveyor, multitemperature machine, 150 degrees F (66 degrees C).^{Pf}

(B) The temperature of the wash solution in spray-type warewashers that use chemicals to sanitize may not be less than 120 degrees F (49 degrees C). ^{Pf}

4-501.111 Manual Warewashing Equipment, Hot Water Sanitization Temperatures.

If immersion in hot water is used for sanitizing in a manual operation, the temperature of the water shall be maintained at 171 degrees F (77 degrees C) or above. ^P

4-501.112 Mechanical Warewashing Equipment, Hot Water Sanitization Temperatures.

(A) Except as specified in (B) of this section, in a mechanical operation, the temperature of the fresh hot water sanitizing rinse as it enters the manifold may not be more than 194 degrees F (90 degrees C) or less than:^{Pf}

- (1) For a stationary rack, single temperature machine, 165 degrees F (74 degrees C); ^{Pf} or
- (2) For all other machines, 180 degrees F (82 degrees C). ^{Pf}

(B) The maximum temperature specified under (A) of this section does not apply to the high pressure and temperature systems with wand-type, hand-held spraying devices used for in-place cleaning and sanitizing of equipment such as meat saws.

4-501.113 Mechanical Warewashing Equipment, Sanitization Pressure.

The flow pressure of the fresh hot water sanitizing rinse in a warewashing machine, as measured in the water line immediately downstream or upstream from the fresh hot water sanitizing rinse control valve, shall be within the range specified on the machine manufacturer's data plate and may not be less than five (5) pounds per square inch (35 kilopascals) or more than thirty (30) pounds per square inch (200 kilopascals).

4-501.114 Manual and Mechanical Warewashing Equipment, Chemical Sanitization Temperature, pH, Concentration, and Hardness.

A chemical sanitizer used in a sanitizing solution for a manual or mechanical operation at contact times specified in 4-703.11(C) shall:

- (A) Meet the criteria specified in 7-204.11;
- (B) Be used in accordance with the EPA registered label use instructions; ^P and
- (C) Be used as follows:
 - (1) A chlorine solution shall have a: ^P
 - (a) Minimum temperature of 75 degrees F (24 degrees C).
 - (b) Concentration between fifty (50) ppm and two hundred (200) ppm.
 - (2) An iodine solution shall have a:
 - (a) Minimum temperature of 68 degrees F (20 degrees C). ^P
 - (b) Concentration between twelve-point five (12.5) ppm and twenty-five (25) ppm. ^P
 - (3) A quaternary ammonium compound solution shall:
 - (a) Have a minimum temperature of 75 degrees F (24 degrees C); ^P
 - (b) Have a concentration as specified in 7-204.11 and as indicated by the manufacturer's use directions included in the labeling; ^P and
 - (c) Be used only in water with 500 mg/L hardness or less or in water having a hardness no greater than specified by the EPA-registered label use instructions. ^P
- (D) If another solution of a chemical specified under (C) of this section is used, the permit holder shall demonstrate to the Department that the solution achieves sanitization and the use of the solution shall be approved; ^P
- (E) If a chemical sanitizer other than chlorine, iodine, or a quaternary ammonium compound is used, it shall be approved by the EPA and applied in accordance with the EPA-registered label use instructions; ^P
- (F) If a chemical sanitizer is generated by a device located on-site at the retail food establishment, it shall be used as specified in (A) through (D) of this section and shall be produced by a device that:
 - (1) Complies with regulations as specified in 2(q)(1) and 12 of the *Federal Insecticide, Fungicide, and Rodenticide Act (FIFRA)*; ^P
 - (2) Complies with 40 CFR 152.500, *Requirement for Devices* and 40 CFR 156.10, *Labeling Requirements*; ^P
 - (3) Displays the EPA device manufacturing facility registration number on the device, ^{Pf} and
 - (4) Is operated and maintained in accordance with manufacturer's instructions. ^{Pf}

4-501.115 Manual Warewashing Equipment, Chemical Sanitization Using Detergent-Sanitizers.

If a detergent-sanitizer is used to sanitize in a cleaning and sanitizing procedure where there is no distinct water rinse between the washing and sanitizing steps, the agent applied in the sanitizing step shall be the same detergent-sanitizer that is used in the washing step.

4-501.116 Warewashing Equipment Determining Chemical Sanitizer Concentration.

Concentration of the sanitizing solution shall be accurately determined by using a test or other device.^{Pf}

4-502 Utensils and Temperature and Pressure Measuring Devices

4-502.11 Good Repair and Calibration.

(A) Utensils shall be maintained in a state of repair or condition that complies with the requirements specified under 4-1 and 4-2 or shall be discarded.

(B) Food temperature measuring devices shall be calibrated in accordance with manufacturer's specifications as necessary to ensure their accuracy. ^{Pf}

(C) Ambient air temperature, water pressure, and water temperature measuring devices shall be maintained in good repair and be accurate within the intended range of use.

4-502.12 Single-Service and Single-Use Articles, Required Use.

A retail food establishment without facilities specified under Section 4-6 and Section 4-7 for cleaning and sanitizing kitchenware and tableware shall provide only single-use kitchenware, single-service articles, and single-use articles for use by food employees and single-service articles for use by consumers. ^P

4-502.13 Single-Service and Single-Use Articles, Use Limitations.

(A) Single-service and single-use articles may not be reused.

(B) A bulk milk container dispensing tube shall be cut on the diagonal leaving no more than one (1) inch protruding from the chilled dispenser head.

4-502.14 Shells, Use Limitations.

Mollusk and crustacean shells may not be used more than once as serving containers.

4-6 CLEANING OF EQUIPMENT AND UTENSILS

4-601 Objective

4-601.11 Equipment, Food Contact Surfaces, Nonfood Non-food Contact Surfaces, and Utensils.

(A) Equipment food contact surfaces and utensils shall be clean to sight and touch. ^{Pf}

(B) Food contact surfaces of cooking equipment and pans shall be kept free of encrusted grease deposits and other soil accumulations.

(C) Non-food contact surfaces shall be cleaned and kept free of an accumulation of dust, dirt, food residue, and other debris.

4-602 Frequency

4-602.11 Equipment Food Contact Surfaces, and Utensils.

(A) Equipment food contact surfaces and utensils shall be cleaned:

(1) Except as specified in (B) of this section, before each use with a different type of raw animal food such as beef, fish, lamb, pork, or poultry; ^P

(2) Each time there is a change from working with raw foods to working with ready-to-eat foods;^P

(3) Between uses with raw fruits and vegetables and with time/temperature control for safety food;^P

(4) Before using or storing a food temperature measuring device; ^P and

(5) At any time during the operation when contamination may have occurred. ^P

(B) Subparagraph (A)(1) of this section does not apply if the food contact surface or utensil is in contact with a succession of different raw meats and poultry each requiring a higher cooking temperature as specified under 3-401.11 than the previous type food.

(C) Except as specified in (D) of this section, if used with time/temperature control for safety food, equipment, food-contact surfaces, and utensils shall be cleaned throughout the day at least every four (4) hours.^P

(D) Surfaces of utensils and equipment contacting time/temperature control for safety food may be cleaned less frequently than every four (4) hours if:

(1) In storage, containers of time/temperature control for safety food and their contents are maintained at temperatures specified under Chapter 3 and the containers are cleaned when they are empty;

(2) Utensils and equipment are used to prepare food in a refrigerated room or area that is maintained at one of the temperatures in the following chart and:

(a) The utensils and equipment are cleaned at the frequency in the following chart that corresponds to the temperature; and

Temperature	Cleaning Frequency
5.0C degrees (41F degrees) or less	24 hours
Greater than 5.0C degrees- 7.2C degrees (Greater than 41F degrees- 45F degrees)	20 hours
Greater than 7.2C degrees- 10.0C degrees (Greater than 45F degrees- 50F degrees)	16 hours
Greater than 10.0C degrees - 12.8C degrees (Greater than 50F degrees- 55F degrees)	10 hours

(b) The cleaning frequency based on the ambient temperature of the refrigerated room or area is documented in the retail food establishment.

(3) Containers in serving situations such as salad bars, delis, and cafeteria lines holding ready-to-eat time/temperature control for safety food that is maintained at the temperatures specified under Chapter 3, are intermittently combined with additional supplies of the same food that is at the required temperature, and the containers are cleaned at least every twenty-four (24) hours;

(4) Temperature measuring devices are maintained in contact with food, such as when left in a container of deli food or in a roast, held at temperatures specified under Chapter 3;

(5) Equipment is used for storage of packaged or unpackaged food, such as a reach-in refrigerator, and the equipment is cleaned at a frequency necessary to preclude accumulation of soil residues;

(6) The cleaning schedule is based on consideration of:

(a) Characteristics of the equipment and its use,

(b) The type of food involved,

(c) The amount of food residue accumulation, and

(d) The temperature at which the food is maintained during the operation and the potential for the rapid and progressive multiplication of pathogenic or toxigenic microorganisms that are capable of causing foodborne disease; or

(7) In-use utensils are intermittently stored in a container of water in which the water is maintained at 135 degrees F (57 degrees C) or more, and the utensils and container are cleaned at least every twenty-four (24) hours or at a frequency necessary to preclude accumulation of soil residues.

(E) Except when dry cleaning methods are used as specified under 4-603.11, surfaces of utensils and equipment contacting food that is not time/temperature control for safety food shall be cleaned:

(1) At any time when contamination may have occurred;

(2) At least every twenty-four (24) hours for iced tea dispensers and consumer self-service utensils such as tongs, scoops, or ladles;

(3) Before restocking consumer self-service equipment and utensils such as condiment dispensers and display containers; and

(4) In equipment such as ice bins and beverage dispensing nozzles and enclosed components of equipment such as ice makers, cooking oil storage tanks and distribution lines, beverage and syrup dispensing lines or tubes, coffee bean grinders, and water vending equipment:

(a) At a frequency specified by the manufacturer or

(b) Absent manufacturer specifications, at a frequency necessary to preclude accumulation of soil or mold.

4-602.12 Cooking and Baking Equipment.

(A) The food-contact surfaces of cooking and baking equipment shall be cleaned at least every twenty-four (24) hours. This section does not apply to hot oil cooking and filtering equipment if it is cleaned at a frequency specified by the manufacturer or at a frequency to preclude accumulation of soil or mold.

(B) The cavities and door seals of microwave ovens shall be cleaned at least every twenty-four (24) hours by using the manufacturer's recommended cleaning procedure.

4-602.13 Non-food-Contact Surfaces.

Non-food-contact surfaces of equipment shall be cleaned at a frequency necessary to preclude accumulation of soil residues.

4-603 Methods

4-603.11 Dry Cleaning.

(A) If used, dry cleaning methods such as brushing, scraping, and vacuuming shall contact only surfaces that are soiled with dry food residues that are not a time/temperature control for safety food.

(B) Cleaning equipment used in dry cleaning food contact surfaces shall not be used for any other purpose.

4-603.12 Pre-cleaning.

(A) Food debris on equipment and utensils shall be scraped over a waste disposal unit or garbage receptacle or shall be removed in a warewashing machine with a prewash cycle.

(B) If necessary for effective cleaning, utensils and equipment shall be preflushed, presoaked, or scrubbed with abrasives.

4-603.13 Loading of Soiled Items, Warewashing Machines.

Soiled items to be cleaned in a warewashing machine shall be loaded into racks, trays, or baskets or onto conveyors in a position that:

(A) Exposes all surfaces of the items to the unobstructed spray from all cycles and

(B) Allows the items to drain.

4-603.14 Wet Cleaning.

(A) Equipment food contact surfaces and utensils shall be effectively washed to remove or completely loosen soils by using the manual or mechanical means necessary such as the application of detergents containing wetting agents and emulsifiers; acid, alkaline, or abrasive cleaners; hot water; brushes; scouring pads; high-pressure sprays; or ultrasonic devices.

(B) The washing procedures selected shall be based on the type and purpose of the equipment or utensil and on the type of soil to be removed.

4-603.15 Washing, Procedures for Alternative Manual Warewashing Equipment.

If washing in sink compartments or a warewashing machine is impractical, such as when the equipment is fixed in place or the utensils are too large, washing shall be done by using alternative manual warewashing equipment as specified in 4-301.12(C) and in accordance with the following procedures:

(A) Equipment shall be disassembled as necessary to allow access of the detergent solution to all parts;

(B) Equipment components and utensils shall be scrapped or rough cleaned to remove food particle accumulation; and

(C) Equipment and utensils shall be washed as specified in 4-603.14(A) to remove soils.

4-603.16 Rinsing Procedures.

Washed utensils and equipment shall be rinsed so that abrasives are removed and cleaning chemicals are removed or diluted through the use of water or a detergent-sanitizer solution by using one of the following procedures:

(A) Use of a distinct, separate water rinse after washing and before sanitizing if using:

- (1) A three (3) compartment sink;
- (2) Alternative manual warewashing equipment equivalent to a three (3) compartment sink as specified in 4-301.12(C);
- (3) A three (3)-step washing, rinsing, and sanitizing procedure in a warewashing system for CIP equipment;

(B) Use of a detergent-sanitizer as specified under 4-501.115 if using:

- (1) Alternative warewashing equipment as specified in 4-301.12(C) that is approved for use with a detergent-sanitizer, or
- (2) A warewashing system for CIP equipment;

(C) Use of a nondistinct water rinse that is integrated in the hot water sanitization immersion step of a two (2) compartment sink operation;

(D) If using a warewashing machine that does not recycle the sanitizing solution as specified under (E) of this section, or alternative manual warewashing equipment such as sprayers, use a nondistinct water rinse that is:

- (1) Integrated in the application of the sanitizing solution and
- (2) Wasted immediately after each application; or

(E) If using a warewashing machine that recycles the sanitizing solution for use in the next wash cycle, use a nondistinct water rinse that is integrated in the application of the sanitizing solution.

4-7 SANITIZATION OF EQUIPMENT AND UTENSILS

4-701 Objective

4-701.10 Food-Contact Surfaces and Utensils.

Equipment food-contact surfaces and utensils shall be sanitized.

4-702 Frequency

4-702.11 Before Use After Cleaning.

Utensils and food contact surfaces of equipment shall be sanitized before use after cleaning. **P**

4-703 Methods

4-703.11 Hot Water and Chemical.

After being cleaned, equipment food contact surfaces and utensils shall be sanitized in:

(A) Hot water manual operations by immersion for at least thirty (30) seconds and as specified in 4-501.111;**P**

(B) Hot water mechanical operations by being cycled through equipment that is set up as specified under 4-501.15, 4-501.112, and 4-501.113 and achieving a utensil surface temperature of 160 degrees F (71 degrees C) as measured by an irreversible registering temperature indicator; **P** or

(C) Chemical, manual, or mechanical operations, including the application of sanitizing chemicals by immersion, manual swabbing, brushing, or pressure spraying methods, using a solution as specified under 4-501.114. Contact times shall be consistent with those on EPA-registered label use instructions by providing:

(1) Except as specified under (C)(2) of this section, a contact time of at least ten (10) seconds for a chlorine solution specified under 4-501.114(C), **P**

(2) A contact time of at least seven (7) seconds for a chlorine solution of 50 MG/L that has a pH of ten (10.0) or less and a temperature of at least 100 degrees F (38 degrees C) or a pH of eight (8.0) or less and a temperature of at least 75 degrees F (24 degrees C), **P**

- (3) A contact time of at least thirty (30) seconds for other chemical sanitizing solutions, ^P or
- (4) A contact time used in relationship with a combination of temperature, concentration, and pH that, when evaluated for efficacy, yields sanitization as defined in 1-201.10(B).^P

4-8 LAUNDERING

4-801 Objective

4-801.11 Linens.

Clean linens shall be free from food residues and other soiling matter.

4-802 Frequency

4-802.11 Specifications.

(A) Linens that do not come in direct contact with food shall be laundered between operations if they become wet, sticky, or visibly soiled.

(B) Cloth gloves used as specified in 3-304.15(D) shall be laundered before being used with a different type of raw animal food such as beef, fish, lamb, pork, or poultry.

(C) Linens that are used as specified in 3-304.13 and cloth napkins shall be laundered between each use.

(D) Wet wiping cloths shall be laundered daily.

(E) Dry wiping cloths shall be laundered as necessary to prevent contamination of food and clean serving utensils.

4-803 Methods

4-803.11 Storage of Soiled Linens.

Soiled linens shall be kept in clean, nonabsorbent receptacles or clean, washable laundry bags and stored and transported to prevent contamination of food, clean equipment, clean utensils, and single-service and single-use articles.

4-803.12 Mechanical Washing.

(A) Except as specified in (B) of this section, linens that come in direct contact with food shall be mechanically laundered.

(B) In retail food establishments in which only wiping cloths are laundered as specified in 4-301.15 (B), the wiping cloths may be laundered in a mechanical washer, a sink designated only for wiping cloths, or a warewashing or food preparation sink that is cleaned as specified in 4-501.14.

4-803.13 Use of Laundry Facilities.

(A) Except as specified in (B) of this section, laundry facilities located on the premises of a retail food establishment shall be used only for the washing and drying of items used in the operation of the establishment.

(B) Separate laundry facilities located on the premises for the purpose of general laundering such as institutions providing boarding and lodging may also be used for laundering retail food establishment linens.

4-9 PROTECTION OF CLEAN ITEMS

4-901 Drying

4-901.11 Equipment and Utensils, Air-Drying Required.

After cleaning and sanitizing, equipment and utensils:

(A) Shall be air-dried or used after adequate draining as specified in the first paragraph of 40 CFR 180.940, *Tolerance Exemptions for Active and Inert Ingredients for use in Antimicrobial Formulations (Food-Contact Surface Sanitizing Solutions)* before contact with food; and

(B) May not be cloth dried, except that utensils that have been air-dried may be polished with cloths that are maintained clean and dry.

4-901.12 Wiping Cloths, Air-Drying Locations.

Wiping cloths laundered in a retail food establishment that does not have a mechanical clothes dryer as specified in 4-301.15(B) shall be air-dried in a location and in a manner that prevents contamination of food, equipment, utensils, linens and single-service and single-use articles and the

wiping cloths. This section does not apply if wiping cloths are stored after laundering in a sanitizing solution as specified under 4-501.114.

4-902 Lubricating and Reassembling

4-902.11 Food-Contact Surfaces.

Lubricants as specified under 7-205.11 shall be applied to food contact surfaces that require lubrication in a manner that does not contaminate food contact surfaces.

4-902.12 Equipment.

Equipment shall be reassembled so that food contact surfaces are not contaminated.

4-903 Storing

4-903.11 Equipment, Utensils, Linens, and Single-Service and Single-Use Articles.

(A) Except as specified in (D) of this section, cleaned equipment and utensils, laundered linens and single-service and single-use articles shall be stored:

- (1) In a clean, dry location; and
- (2) Where they are not exposed to splash, dust, or other contamination; and
- (3) At least six (6) inches (15 centimeters) above the floor.

(B) Clean equipment and utensils shall be stored as specified in (A) of this section and shall be stored:

- (1) In a self-draining position that allows for air drying; and
- (2) Covered or inverted.

(C) Single-service and single-use articles shall be stored as specified under (A) of this section and shall be kept in the original protective package or stored by using other means that afford protection from contamination until used.

(D) Items that are kept in closed packages shall be stored less than six (6) inches (15 centimeters) above the floor on dollies, pallets, racks, and skids that are designed as specified under 4-204.122.

4-903.12 Prohibitions.

(A) Except as specified in (B) of this section, cleaned and sanitized equipment, utensils, laundered linens, and single-service and single-use articles shall not be stored:

- (1) In locker rooms;
- (2) In toilet rooms;
- (3) In garbage rooms;
- (4) In mechanical rooms;
- (5) Under sewer lines that are not shielded to intercept potential drips;
- (6) Under leaking water lines including leaking automatic fire sprinkler heads or under lines on which water has condensed;
- (7) Under open stairwells; or
- (8) Under other sources of contamination.

(B) Laundered linens and single-service and single-use articles that are packaged or in a facility such as a cabinet may be stored in a locker room.

4-904 Preventing Contamination

4-904.11 Kitchenware and Tableware.

(A) Single-service and single-use articles and cleaned and sanitized utensils shall be handled, displayed, and dispensed so that contamination of food and lip-contact surfaces is prevented.

(B) Knives, forks, and spoons that are not pre-wrapped shall be presented so that only the handles are touched by employees and by consumers if consumer self-service is provided.

(C) Except as specified in (B) of this section, single-service articles that are intended for food or lip-contact shall be furnished for consumer self-service with the original individual wrapper intact or from an approved dispenser.

4-904.12 Soiled and Clean Tableware.

Soiled tableware shall be removed from consumer eating and drinking areas and handled so that clean tableware is not contaminated.

4-904.13 Preset Tableware.

(A) Except as specified in (B) of this section, tableware that is preset shall be protected from contamination by being wrapped, covered, or inverted.

(B) Preset tableware may be exposed if:

- (1) Unused settings are removed when a consumer is seated; or
- (2) Settings not removed when a consumer is seated are cleaned and sanitized before further use.

4-904.14 Rinsing Equipment and Utensils after Cleaning and Sanitizing.

After being cleaned and sanitized, equipment and utensils shall not be rinsed before air-drying or use unless:

(A) The rinse is applied directly from a potable water supply by a warewashing machine that is maintained and operated as specified under 4-204 and 4-501 and

(B) The rinse is applied only after the equipment and utensils have been sanitized by the application of hot water or by the application of a chemical sanitizer solution whose EPA registered label use instructions call for rinsing off the sanitizer after it is applied in a commercial warewashing machine.

Chapter 5 Water, Plumbing, and Waste

5-1 WATER

5-101 Source

5-101.11 Approved System.

Drinking water shall be obtained from an approved source that is:

- (A) An existing public water system ^P (e.g., municipality);
- (B) A new public water system (including a well) constructed for the purpose of serving the retail food establishment that is constructed, maintained, and operated according to R.61-58, *State Primary Drinking Water Regulation*; ^P
 - (1) The owner shall provide the Department with a copy of the public water system *Operating Permit* or *Public Water Supply Construction Permit and Approval to Place into Operation* prior to the issuance of a permit to operate the retail food establishment;
 - (2) Upon the date of written notification from the Department to the owner/retail food establishment that the water supply to the retail food establishment does not meet acceptable standards for drinking water consumption, the retail food establishment shall immediately cease its food operation; ^P
- (C) An approved water transport vehicle filled from a source that complies with (A) or (B) above;^P
- (D) An approved water container filled from a source that complies with (A) or (B) above; ^P or
- (E) An on-premises water storage tank filled from a source that complies with (A) or (B) above.^P

5-101.12 System Flushing and Disinfection.

A drinking water system shall be flushed and sampled for the presence of bacteria before being placed in service after construction, repair, or modification and after an emergency situation, such as a flood, or a water main break, that may introduce contaminants to the system. ^P

5-101.13 Bottled Drinking Water.

Bottled drinking water used or sold in a retail food establishment shall be obtained from approved sources in accordance with 21 CFR 129, *Processing and Bottling of Bottled Drinking Water*.^P

5-102 Quality

5-102.11 Standards.

Water from a public water system shall meet 40 CFR 141, *National Primary Drinking Water Regulations*, and R.61-58, *State Primary Drinking Water Regulations*. ^P

5-102.12 Nondrinking Water.

(A) A nondrinking water supply shall be used only if its use is approved. **P**

(B) Nondrinking water shall be used only for nonculinary purposes such as air conditioning, nonfood equipment cooling, and fire protection. **P**

5-102.13 Sampling.

Except when used as specified under 5-102.12, water from a public water system shall be sampled and tested at least annually and as required by R.61-58, *State Primary Drinking Water Regulations*. **Pf**

5-102.14 Sampling Report.

The most recent sample report for the public water system shall be maintained as specified by R.61-58, *State Primary Drinking Water Regulations*.

5-103 Quantity and Availability

5-103.11 Capacity.

(A) The water source and system shall be of sufficient capacity to meet the peak water demands of the retail food establishment. **Pf**

(B) Hot water generation and distribution systems shall be sufficient to meet the peak hot water demands throughout the retail food establishment. **Pf**

5-103.12 Pressure.

Water under pressure shall be provided to all fixtures, equipment, and nonfood equipment that are required to use water except that water supplied as specified under 5-104.12(A) and (B) in response to a temporary interruption of a water supply need not be under pressure. **Pf**

5-104 Distribution, Delivery, and Retention

5-104.11 System.

Water shall be received from the source through the use of:

(A) An approved public water main; **Pf** or

(B) One or more of the following that shall be constructed, maintained, and operated according to law: **Pf**

(1) Water pumps, pipes, hoses, connections, and other appurtenances; **Pf**

(2) Water transport vehicles; **Pf** or

(3) Water containers. **Pf**

5-104.12 Alternative Water Supply.

Water meeting the requirements specified under 5-101, 5-102, and 5-103 shall be made available for a mobile facility, for a temporary food establishment without a permanent water supply, and for a retail food establishment with a temporary interruption of its water supply through:

(A) A supply of containers of commercially bottled drinking water; **Pf**

(B) One or more closed portable water containers; **Pf**

(C) An enclosed vehicular water tank; **Pf**

(D) An on-premises water storage tank; **Pf** or

(E) Piping, tubing, or hoses connected to an adjacent approved source. **Pf**

5-2 PLUMBING SYSTEM

5-201 Materials

5-201.11 Approved

(A) A plumbing system and hoses conveying water shall be constructed and repaired with approved materials according to the law. **P**

(B) A water filter shall be made of safe materials. **P**

5-202 Design, Construction, and Installation

5-202.11 Approved System and Cleanable Fixtures.

(A) A plumbing system shall be designed, constructed, and installed according to law. **P**

(B) A plumbing fixture such as a handwashing sink, toilet, or urinal shall be easily cleanable.

5-202.12 Handwashing Sink, Installation.

(A) A handwashing sink shall be equipped to provide water at a temperature of at least 100 degrees F (38 degrees C) through a mixing valve or combination faucet. **P^f**

(B) A steam mixing valve may not be used at a handwashing sink.

(C) A self-closing, slow-closing, or metering faucet shall provide a flow of water for at least fifteen (15) seconds without the need to reactivate the faucet.

(D) An automatic handwashing facility shall be installed in accordance with manufacturer's instructions.

5-202.13 Backflow Prevention, Air Gap.

An air gap between the water supply inlet and the flood level rim of the plumbing fixture, equipment, or nonfood equipment shall be at least twice the diameter of the water supply inlet and may not be less than one (1) inch (25 mm).**P**

5-202.14 Backflow Prevention Device, Design Standard.

A backflow prevention device installed on the internal water supply system shall meet American Society of Sanitary Engineering (A.S.S.E.) standards for construction, installation, maintenance, inspection, and testing for that specific application and type of device. **P**

5-202.15 Conditioning Device, Design.

A water filter, screen, and other water conditioning device installed on water lines shall be designed to facilitate disassembly for periodic servicing and cleaning. A water filter element shall be of the replaceable type.

5-203 Numbers and Capacities

5-203.11 Handwashing Sinks.

(A) Except as specified in (B) of this section, at least one (1) handwashing sink necessary for their convenient use by employees in areas specified under 5-204.11 shall be provided. Additional handwashing sinks may be required based on the size and operational flow of the establishment. There shall not be fewer than the number of handwashing sinks required by law.

(B) If approved and capable of removing the types of soils encountered in the food operations involved, automatic handwashing facilities may be substituted for handwashing sinks in a retail food establishment that has a least one (1) handwashing sink.

5-203.12 Toilets and Urinals.

At least one (1) toilet, and not fewer than the toilets required by law, shall be provided. If authorized by law and urinals are substituted for toilets, the substitution shall be done as specified in law.

5-203.13 Service Sink.

(A) At least one (1) service sink or one (1) curbed cleaning facility equipped with a floor drain shall be provided and conveniently located for the cleaning of mops or similar wet floor cleaning tools and for the disposal of mop water and similar liquid waste.

(B) Toilets and urinals may not be used as a service sink for the disposal of mop water and similar liquid waste.

5-203.14 Backflow Prevention Device, When Required.

A plumbing system shall be installed to preclude backflow of a solid, liquid, or gas contaminant into the water supply system at each point of use at the retail food establishment, including on a hose bibb if a hose is attached or on a hose bibb if a hose is not attached and backflow prevention is required by law, by:

(A) Providing an air gap as specified under 5-202.13; **P** or

(B) Installing an approved backflow prevention device as specified under 5-202.14. **P**

5-203.15 Backflow Prevention Device, Carbonator.

(A) If not provided with an approved air gap as specified under 5-202.13, a dual check valve with an intermediate vent preceded by a screen of not less than one hundred (100) mesh to one (1) inch (100 mesh to 25.4 mm) shall be installed upstream from a carbonating device and downstream from any copper in the water supply line. **P**

(B) A dual check valve attached to the carbonator need not be of the vented type if an air gap or vented backflow prevention device has been otherwise provided as specified in (A) of this section.

5-204 Location and Placement

5-204.11 Handwashing Sinks.

A handwashing sink shall be located:

(A) To allow convenient use by employees, in food preparation, food dispensing, and warewashing areas; **Pf** and

(B) In, or immediately adjacent to, toilet rooms. **Pf**

5-204.12 Backflow Prevention Device, Location.

A backflow prevention device shall be located so that it may be serviced and maintained.

5-204.13 Conditioning Device, Location.

A water filter, screen, and other water conditioning device installed on water lines shall be located to facilitate disassembly for periodic servicing and cleaning.

5-205 Operation and Maintenance

5-205.11 Using a Handwashing Sink.

(A) A handwashing sink shall be maintained so that it is accessible at all times for employee use. **Pf**

(B) A handwashing sink shall not be used for purposes other than handwashing. **Pf**

(C) An automatic handwashing facility shall be used in accordance with manufacturer's instructions. **Pf**

5-205.12 Prohibiting a Cross Connection.

(A) A person may not create a cross connection by connecting a pipe or conduit between the drinking water system and a nondrinking water system or a water system of unknown quality. **P**

(B) The piping of a nondrinking water system shall be durably identified so that it is readily distinguishable from piping that carries drinking water. **Pf**

5-205.13 Scheduling Inspection and Service for a Water System Device.

A device such as a water treatment device or backflow prevention device shall be scheduled for inspection and service in accordance with manufacturer's instructions and as necessary to prevent device failure based on local water conditions, and records demonstrating inspection and service shall be maintained by the person in charge. **Pf**

5-205.14 Water Reservoir of Fogging Devices, Cleaning.

(A) A reservoir that is used to supply water to a device such as a produce fogger shall be:

(1) Maintained in accordance with manufacturer's specifications; **P** and

(2) Cleaned in accordance with manufacturer's specifications or according to the procedures specified in (B) of this section, whichever is more stringent. **P**

(B) Cleaning procedures shall include at least the following steps and shall be conducted at least once a week:

(1) Draining and complete disassembly of the water and aerosol contact parts; **P**

(2) Brush-cleaning the reservoir, aerosol tubing, and discharge nozzles with a suitable detergent solution; **P**

(3) Flushing the complete system with water to remove the detergent solution and particulate accumulation; **P** and

(4) Rinsing by immersing, spraying, or swabbing the reservoir, aerosol tubing, and discharge nozzles with at least 50 mg/l hypochlorite solution. **P**

5.205.15 System Maintained in Good Repair.

A plumbing system shall be:

- (A) Repaired according to law^P and
- (B) Maintained in good repair.

5-3 MOBILE WATER TANK AND MOBILE FOOD ESTABLISHMENT WATER TANK

5-301 Materials

5-301.11 Approved.

Materials that are used in the construction of a mobile water tank, mobile food establishment water tank, and appurtenances shall comply with NSF 372 and shall have a weighted average lead content of 0.25 percent or less and meet either ANSI/NSF Standard 59 or 61.^P

5-302 Design and Construction

5-302.11 Enclosed System, Sloped to Drain.

A mobile water tank shall be:

- (A) Enclosed from the filling inlet to the discharge outlet and
- (B) Sloped to an outlet that allows complete drainage of the tank.

5-302.12 Inspection and Cleaning Port, Protected and Secured.

If a water tank is designed with an access port for inspection and cleaning, the opening shall be in the top of the tank and:

- (A) Flanged upward at least one-half inch (13 mm) and
- (B) Equipped with a port cover assembly that is:
 - (1) Provided with a gasket and a device for securing the cover in place and
 - (2) Flanged to overlap the opening and sloped to drain.

5-302.13 "V" Type Threads, Use Limitation.

A fitting with "V" type threads on a water tank inlet or outlet shall be allowed only when a hose is permanently attached.

5-302.14 Tank Vent, Protected.

If provided, a water tank vent shall terminate in a downward direction and shall be covered with:

- (A) Sixteen (16) mesh to one (1) inch (25.4 mm) screen or equivalent when the vent is in a protected area or
- (B) A protective filter when the vent is in an area that is not protected from windblown dirt and debris.

5-302.15 Inlet and Outlet, Sloped to Drain.

- (A) A water tank and its inlet and outlet shall be sloped to drain.
- (B) A water tank inlet shall be positioned so that it is protected from contaminants such as waste discharge, road dust, oil, or grease.

5-302.16 Hose, Construction, and Identification.

A hose used for conveying drinking water from a water tank shall be:

- (A) Safe; ^P
- (B) Durable, corrosion resistant, and nonabsorbent;
- (C) Resistant to pitting, chipping, crazing, scratching, scoring, distortion, or decomposition;
- (D) Finished with a smooth interior surface; and
- (E) Clearly and durably identified as to its use if not permanently attached.

5-303 Numbers and Capacities

5-303.11 Filter, Compressed Air.

A filter that does not pass oil or oil vapors shall be installed in the air supply line between the compressor and drinking water system when compressed air is used to pressurize the water tank system. ^P

5-303.12 Protective Cover or Device.

A cap and keeper chain, closed cabinet, closed storage tube, or other approved protective cover or device shall be provided for a water inlet, outlet, and hose.

5-303.13 Mobile Food Establishment Tank Inlets.

A mobile food establishment water tank inlet shall be:

- (A) Nineteen-point one (19.1) mm (three-fourths inch) in inner diameter or less and
- (B) Provided with a hose connection of a size or type that will prevent its use for any other service.

5-304 Operation and Maintenance

5-304.11 System Flushing and Sanitization.

A water tank, pump, and hoses shall be flushed and sanitized before being placed in service after construction, repair, modification, and periods of non-use. ^P

5-304.12 Using a Pump and Hoses, Backflow Prevention.

A person shall operate a water tank, pump, and hoses so that backflow and other contamination of the water supply are prevented.

5-304.13 Protecting Inlet, Outlet, and Hose Fitting.

If not in use, a water tank and hose inlet and outlet fitting shall be protected using a cover or device as specified in 5-303.12.

5-304.14 Tank, Pump, and Hoses Dedication.

(A) Except as specified in (B) of this section, a water tank, pump, and hoses used for conveying drinking water shall be used for no other purpose. ^P

(B) Water tanks, pumps, and hoses approved for liquid foods may be used for conveying drinking water if they are cleaned and sanitized before they are used to convey water.

5-4 SEWAGE, OTHER LIQUID WASTE, AND RAINWATER

5-401 Mobile Holding Tank

5-401.11 Capacity and Drainage.

A sewage holding tank in a mobile food establishment shall be:

- (A) Sized fifteen (15) percent larger in capacity than the water supply tank; and
- (B) Sloped to a drain that is one (1) inch (25 mm) in inner diameter or greater and equipped with a shut-off valve.

5-402 Retention, Drainage, and Delivery

5-402.10 Establishment Drainage System.

Retail food establishment drainage systems, including grease traps that convey sewage, shall be designed and installed as specified under 5-202.11(A).

5-402.11 Backflow Prevention.

(A) Except as specified in (B), (C), and (D) of this section, a direct connection may not exist between the sewage system and a drain originating from equipment in which food, portable equipment, or utensils are placed. ^P

(B) Paragraph (A) of this section does not apply to floor drains that originate in refrigerated spaces that are constructed as an integral part of the building.

(C) If allowed by law, a warewashing machine may have a direct connection between its waste outlet and a floor drain when the machine is located within five (5) feet (1.5 m) of a trapped floor drain and the machine outlet is connected to the inlet side of a properly vented floor drain trap.

(D) If allowed by law, a warewashing or culinary sink may have a direct connection.

5-402.12 Grease Traps and Grease Interceptors.

If used, a grease trap or grease interceptor shall be located to be easily accessible for cleaning.

(A) Grease Traps.

(1) When required by the sewer purveyor, grease traps shall be located outside to be easily accessible for cleaning and servicing, except when the building is the property line; a grease trap may be installed inside a retail food establishment, provided the grease trap complies as specified in (2), (3), and (4) of this section.

(2) Grease traps shall not be installed in food preparation areas, food storage areas, equipment and utensil washing areas, food dispensing areas, or in areas where food equipment and single-service articles are stored.

(3) Grease trap servicing hoses and pumps shall not run through food preparation areas, food storage areas, equipment and utensil washing areas, food dispensing areas, or in areas where food equipment and single-service articles are stored.

(4) Facilities with existing grease traps that are located in food preparation areas, food storage areas, equipment and utensil washing areas, or food dispensing areas, prior to the effective date of this regulation, which require inspection, servicing, or maintenance shall:

(a) Temporarily close for business and shall cease all food preparation and utensils washing activities during inspection, servicing, or maintenance of the grease trap; and

(b) Immediately after inspection, servicing, or maintenance, clean and sanitize the grease trap area and adjacent surfaces before re-opening for business and resuming food service activities.

(B) Grease Interceptors.

(1) When required by the sewer purveyor, grease interceptors may be installed in food preparation, food storage, equipment, and utensil washing areas.

(2) Grease interceptors on the floor shall have a minimum unobstructed clearance of twenty-four (24) inches above the interceptors to allow access for servicing and maintenance and shall have a minimum of six (6) inch spacing to walls or adjacent surfaces to allow access for cleaning around the grease interceptor.

(3) Grease interceptors fully recessed or recessed with an extension to floor level shall not have equipment placed on top of the unit and shall have a minimum unobstructed clearance of twenty-four (24) inches above the grease interceptor, except for floor-mounted equipment that is mobile or portable.

(4) Grease interceptors shall be manually serviced. Grease servicing hoses and pumps are prohibited in food preparation areas, food storage areas, equipment and utensil washing areas, food dispensing areas, or in areas where food equipment and single-service articles are stored.

(5) Immediately following an inspection, servicing, or maintenance of a grease interceptor located inside a retail food establishment, the grease interceptor and the surrounding area shall be cleaned and sanitized.

5-402.13 Conveying Sewage.

Sewage shall be conveyed to the point of disposal through an approved sanitary sewage system or other system, including use of sewage transport vehicles, waste retention tanks, pumps, pipes, hoses, and connections that are constructed, maintained, and operated according to law. ^P

5-402.14 Removing Mobile Food Establishment Wastes.

Sewage and other liquid wastes shall be removed from a mobile food establishment at an approved waste servicing area or by a sewage transport vehicle in such a way that a public health hazard or nuisance is not created or that sewage is not discharged to the environment. ^{Pf}

5-402.15 Flushing a Waste Retention Tank.

A tank for liquid waste retention shall be thoroughly flushed and drained in a sanitary manner during the servicing operation.

5-403 Disposal Facility

5-403.11 Approved Sewage Disposal System.

Sewage shall be disposed through an approved facility that is:

(A) A public sewage treatment plant^P or

(B) An individual sewage disposal system that is sized, constructed, maintained, and operated according to law.^P

5-403.12 Other Liquid Wastes and Rainwater.

Condensate drainage and other nonsewage liquids and rainwater shall be drained from the point of discharge to disposal according to law.

5-5 REFUSE, RECYCLABLES, AND RETURNABLES

5-501 Facilities on the Premises

5-501.10 Indoor Storage Area.

If located within the retail food establishment, a storage area for refuse, recyclables, and returnables shall meet the requirements specified under 6-101.11, 6-201.11 through 6-201.18, 6-202.15, and 6-202.16.

5-501.11 Outdoor Storage Surface.

An outdoor storage surface for refuse, recyclables, and returnables shall be constructed of nonabsorbent material such as concrete or asphalt and shall be smooth, durable, and sloped to drain.

5-501.12 Outdoor Enclosure.

If used, an outdoor enclosure for refuse, recyclables, and returnables shall be constructed of durable and cleanable materials.

5-501.13 Receptacles.

(A) Except as specified in (B) of this section, receptacles and waste handling units for refuse, recyclables, and returnables, and for use with materials containing food residue shall be durable, cleanable, insect and rodent-resistant, leakproof, and nonabsorbent.

(B) Plastic bags and wet strength paper bags may be used to line receptacles for storage inside the retail food establishment, or within closed outside receptacles.

5-501.15 Outside Receptacles.

(A) Receptacles and waste handling units for refuse, recyclables, and returnables used with materials containing food residue and used outside the retail food establishment shall be designed and constructed to have tight-fitting lids, doors, or covers.

(B) Receptacles and waste handling units for refuse and recyclables, such as an on-site compactor, shall be installed so that accumulation of debris, insect and rodent attraction, and harborage are minimized and effective cleaning is facilitated around and, if the unit is not installed flush with the base pad, under the unit.

5-501.16 Storage Areas, Rooms, and Receptacles, Capacity and Availability.

(A) An inside storage room and area, outside storage area and enclosure, and receptacles shall be of sufficient capacity to hold refuse, recyclables, and returnables that accumulate.

(B) A receptacle shall be provided in each area of the retail food establishment or premises where refuse is generated or commonly discarded, or where recyclables or returnables are placed.

(C) If disposable towels are used at handwashing lavatories, a waste receptacle shall be located at each lavatory or group of adjacent lavatories.

5-501.17 Toilet Room Receptacle, Covered.

A toilet room used by females shall be provided with a covered receptacle for sanitary napkins.

5-501.18 Cleaning Implements and Supplies.

(A) Except as specified in (B) of this section, suitable cleaning implements and supplies, such as high pressure pumps, hot water, steam, and detergent, shall be provided as necessary for effective cleaning of receptacles and waste handling units for refuse, recyclables, and returnables.

(B) If approved, off-premises-based cleaning services may be used if on-premises cleaning implements and supplies are not provided.

5-501.19 Storage Areas, Redeeming Machines, Receptacles, and Waste Handling Units, Location.

(A) An area designated for refuse, recyclables, returnables, and, except as specified in (B) of this section, a redeeming machine for recyclables or returnables shall be located so that it is separate from food, equipment, utensils, linens, and single-service and single-use articles and a public health hazard or nuisance is not created.

(B) A redeeming machine may be located in the packaged food storage area or consumer area of a retail food establishment if food, equipment, utensils, linens, and single-service and single-use articles are not subject to contamination from the machines and a public health hazard or nuisance is not created.

(C) The location of receptacles and waste handling units for refuse, recyclables, and returnables may not create a public health hazard or nuisance or interfere with the cleaning of adjacent space.

5-501.110 Storing Refuse, Recyclables, and Returnables.

Refuse, recyclables, and returnables shall be stored in receptacles or waste handling units so that they are inaccessible to insects and rodents.

5-501.111 Areas, Enclosures, and Receptacles, Good Repair.

Storage areas, receptacles, and enclosures for refuse, recyclables, or returnables shall be maintained in good repair.

5-501.112 Outside Storage Prohibitions.

(A) Except as specified in (B) of this section, refuse receptacles not meeting the requirements specified under 5-501.13(A) such as receptacles that are not rodent-resistant, unprotected plastic bags and paper bags, or baled units that contain materials with food residue may not be stored outside.

(B) Cardboard or other packaging material that does not contain food residues and that is awaiting regularly scheduled delivery to a recycling or disposal site may be stored outside without being in a covered receptacle if it is stored so that it does not create a rodent harborage problem.

5-501.113 Covering Receptacles.

Receptacles and waste handling units for refuse, recyclables, and returnables shall be kept covered:

(A) Inside the retail food establishment if the receptacles and units:

- (1) Contain food residue and are not in continuous use or
- (2) After they are filled and

(B) With tight-fitting lids or doors if kept outside the retail food establishment.

5-501.114 Using Drain Plugs.

Drains in receptacles and waste handling units for refuse, recyclables, and returnables shall have drain plugs in place.

5-501.115 Maintaining Refuse Areas and Enclosures.

A storage area and enclosure for refuse, recyclables, or returnables shall be maintained free of unnecessary items, as specified under 6-501.114, and clean.

5-501.116 Cleaning Receptacles.

(A) Receptacles and waste handling units for refuse, recyclables, and returnables shall be thoroughly cleaned in a way that does not contaminate food, equipment, utensils, linens, or single-service and single-use articles, and waste water shall be disposed of as specified under 5-402.13.

(B) Soiled receptacles and waste handling units for refuse, recyclables, and returnables shall be cleaned at a frequency necessary to prevent them from developing a buildup of soil or becoming attractants for insects and rodents.

5-502 Removal

5-502.11 Frequency.

Refuse, recyclables, and returnables shall be removed from the premises at a frequency that will minimize the development of objectionable odors and other conditions that attract or harbor insects and rodents.

5-502.12 Receptacles or Vehicles.

Refuse, recyclables, and returnables shall be removed from the premises by way of:

- (A) Portable receptacles that are constructed and maintained according to law or
- (B) A transport vehicle that is constructed, maintained, and operated according to law.

5-503 Facilities for Disposal and Recycling

5-503.11 Community or Individual Facility.

Solid waste not disposed of through the sewage system such as through grinders and pulpers shall be recycled or disposed of in an approved public or private community recycling or refuse facility; or solid waste shall be disposed of in an individual refuse facility, such as a landfill or incinerator, which is sized, constructed, maintained, and operated according to law.

Chapter 6 Physical Facilities

6-1 MATERIALS FOR CONSTRUCTION AND REPAIR

6-101 Indoor Areas

6-101.11 Surface Characteristics.

Materials for indoor floor, wall, and ceilings surfaces under conditions of normal use shall be:

- (A) Smooth, durable, and easily cleanable for areas where retail food establishment operations are conducted;
- (B) Closely woven and easily cleanable carpet for carpeted areas; and
- (C) Nonabsorbent for areas subject to moisture such as food preparation areas, walk-in refrigerators, warewashing areas, toilet rooms, mobile food establishment servicing areas, and areas subject to flushing or spray cleaning methods.

6-102 OUTDOOR AREAS

6-102.11 Surface Characteristics.

(A) The outdoor walking and driving areas shall be surfaced with concrete, asphalt, gravel, or other materials that have been effectively treated to minimize dust, facilitate maintenance, and prevent muddy conditions.

(B) Exterior surfaces of buildings and mobile food establishments shall be of weather-resistant materials and shall comply with law.

(C) Outdoor storage areas for refuse, recyclables, or returnables shall be of materials specified under 5-501.11 and 5-501.12.

6-2 DESIGN, CONSTRUCTION, AND INSTALLATION

6-201 Cleanability

6-201.11 Floors, Walls, and Ceilings.

Except as specified under 6-201.14 and except for antislip floor coverings or applications that may be used for safety reasons, floors, floor coverings, walls, wall coverings, and ceilings shall be designed, constructed, and installed so they are smooth and easily cleanable.

6-201.12 Floors, Walls, and Ceilings, Utility Lines.

- (A) Utility service lines and pipes may not be unnecessarily exposed.
- (B) Exposed utility service lines and pipes shall be installed so they do not obstruct or prevent cleaning of the floors, walls, or ceilings.
- (C) Exposed horizontal utility service lines and pipes may not be installed on the floor.

6-201.13 Floor and Wall Junctures, Coved and Enclosed or Sealed.

(A) In retail food establishments in which cleaning methods other than water flushing are used for cleaning floors, the floor and wall junctures shall be coved and closed to no larger than one (1) thirty-second inch (1 mm).

(B) The floors in retail food establishments in which water flush cleaning methods are used shall be provided with drains and be graded to drain. The floor and wall junctures shall be coved and sealed.

6-201.14 Floor Carpeting, Restrictions and Installation.

(A) A floor covering such as carpeting or similar material may not be installed as a floor covering in food preparation areas, walk-in refrigerators, warewashing areas, toilet room areas where handwashing lavatories, toilets, and urinals are located, refuse storage rooms, or other areas where the floor is subject to moisture, flushing, or spray cleaning methods.

(B) If carpeting is installed as a floor covering in areas other than those specified under (A) of this section, it shall be:

(1) Securely attached to the floor with a durable mastic, by using a stretch and tack method, or by another method; and

(2) Installed tightly against the wall under the coving or installed away from the wall with a space between the carpet and the wall and with the edges of the carpet secured by metal stripping or some other means.

6-201.15 Floor Covering, Mats and Duckboards.

Mats and duckboards shall be designed to be removable and easily cleanable.

6-201.16 Wall and Ceiling Coverings and Coatings.

(A) Wall and ceiling covering materials shall be attached so that they are easily cleanable.

(B) Except in areas used only for dry storage, concrete, porous blocks, or bricks used for indoor wall construction shall be finished and sealed to provide a smooth, nonabsorbent, easily cleanable surface.

6-201.17 Wall and Ceiling, Attachments.

(A) Except as specified in (B) of this section, attachments to walls and ceilings such as light fixtures, mechanical room ventilation system components, vent covers, wall mounted fans, decorative items, and other attachments shall be easily cleanable.

(B) In a consumer area, wall and ceiling surfaces and decorative items and attachments that are provided for ambiance need not meet this requirement if they are kept clean.

6-201.18 Walls and Ceiling, Studs, Joists, and Rafters.

Except for temporary food establishments, studs, joists, and rafters may not be exposed in areas subject to moisture.

6-202 Functionality

6-202.11 Light Bulbs, Protective Shielding.

(A) Except as specified in (B) of this section, light bulbs shall be shielded, coated, or otherwise shatter-resistant in areas where there is exposed food, clean equipment, utensils and linens, or unwrapped single-service and single-use articles.

(B) Shielded, coated, or otherwise shatter-resistant bulbs need not be used in areas used only for storing food in unopened packages, if:

(1) The integrity of the packages cannot be affected by broken glass falling onto them and

(2) The packages are capable of being cleaned of debris from broken bulbs before the packages are opened.

(C) An infrared or other heat lamp shall be protected against breakage by a shield surrounding and extending beyond the bulb so that only the face of the bulb is exposed.

6-202.12 Heating, Ventilating, Air-conditioning System Vents.

Heating, ventilating, and air conditioning systems shall be designed and installed so that make-up air intake and exhaust vents do not cause contamination of food, food-contact surfaces, equipment, or utensils.

6-202.13 Insect Control Devices, Design, and Installation.

(A) Insect control devices that are used to electrocute or stun flying insects shall be designed to retain the insect within the device.

(B) Insect control devices shall be installed so that:

(1) The devices are not located over a food preparation area and

(2) Dead insects and insect fragments are prevented from being impelled onto or falling on exposed food, clean equipment, utensils, linens, and unwrapped single-service and single-use articles.

6-202.14 Toilet Rooms, Enclosed.

Except where a toilet room is located outside a retail food establishment and does not open directly into the retail food establishment such as a toilet room that is provided by the management of a shopping mall, a toilet room located on the premises shall be completely enclosed and provided with a tight-fitting and self-closing door or, for a public access restroom, an alcove opening as approved by local building codes.

6-202.15 Outer Openings Protected.

(A) Except as specified in (B), (C), (E), and under (D) of this section, outer openings of a retail food establishment shall be protected against the entry of insects and rodents by:

- (1) Filling or closing the holes and other gaps along floors, walls, and ceiling;
- (2) Closed tight-fitting windows; and
- (3) Solid, self-closing, tight-fitting doors.

(B) Paragraph (A) of this section does not apply if a retail food establishment opens into a larger structure, such as a mall, airport, or office building, or into an attached structure, such as a porch, and the outer openings from the larger or attached structure are protected against the entry of insects and rodents.

(C) Exterior doors used as exits need not be self-closing if they are:

- (1) Solid and tight-fitting;
- (2) Designated for use, only when an emergency exists, by the fire protection authority that has jurisdiction over the retail food establishment; and
- (3) Limited-use so they are not used for entrance or exit from the building for purposes other than the designated emergency exit use.

(D) Except as specified in (B) and (E) of this section, if the windows or doors of a retail food establishment or of a larger structure within which a retail food establishment is located, are kept open for ventilation or other purposes the openings shall be protected against the entry of insects and rodents by:

- (1) Sixteen (16) mesh to one (1) inch (16 mesh to 25.4 mm) screens;
- (2) Properly designed and installed air curtains to control flying insects; or
- (3) Other effective means.

(E) Paragraph (D) of this section does not apply if flying insects and other pests are absent due to the location of the establishment, the weather, or other limiting conditions.

6-202.16 Exterior Walls and Roofs, Protective Barrier.

Perimeter walls and roofs shall effectively protect the retail food establishment from the weather and the entry of insects, rodents, and other animals.

6-202.18 Outdoor Servicing Areas, Overhead Protection.

Except for areas used only for the loading of water or the discharge of sewage and other liquid waste through the use of a closed system of hoses, servicing areas shall be provided with overhead protection.

6-202.19 Outdoor Walking and Driving Surfaces, Graded to Drain.

Exterior walking and driving surfaces shall be graded to drain.

6-202.110 Outdoor Refuse Areas, Curbed and Graded to Drain.

Outdoor refuse areas shall be constructed in accordance with law and shall be curbed and graded to drain to collect and dispose of liquid waste that results from the refuse and from cleaning the area and waste receptacles.

6-202.111 Private Residence and Living or Sleeping Quarters, Use Prohibition.

A private home, a room used as living or sleeping quarters, or an area directly opening into a room used as living or sleeping quarters may not be used for conducting retail food establishment operations. ^P

6-202.112 Living or Sleeping Quarters, Separation.

Living or sleeping quarters located in the premises of a retail food establishment, such as those provided for lodging registration clerks or resident managers, shall be separated from rooms and areas used for retail food establishment operations by complete partitioning and solid self-closing doors.

6-3 NUMBERS AND CAPACITIES

6-301 Handwashing Sinks

6-301.10 Minimum Number.

Handwashing sinks shall be provided as specified under 5-203.11.

6-301.11 Handwashing Cleanser, Availability.

Each handwashing sink or group of two (2) adjacent handwashing sinks shall be provided with a supply of hand cleaning liquid, powder, or bar soap. ^{Pf}

6-301.12 Hand Drying Provision.

Each handwashing sink or group of adjacent handwashing sinks shall be provided with:

- (A) Individual disposable towels; ^{Pf} or
- (B) A continuous towel system that supplies the user with a clean towel; ^{Pf} or
- (C) A heated-air hand drying device; ^{Pf} or
- (D) A hand-drying device that employs an air-knife system that delivers high velocity, pressurized air at ambient temperatures. ^{Pf}

6-301.13 Handwashing Aids and Devices, Use Restrictions.

A sink used for food preparation or utensil washing, a service sink, or curbed cleaning facility used for the disposal of mop water or similar wastes may not be provided with the handwashing aids and devices required for a handwashing sink as specified under 5-501.16(C), 6-301.11 and 6-301.12.

6-301.14 Handwashing Signage.

A sign or poster that notifies food employees to wash their hands shall be provided at all handwashing sinks used by food employees and shall be clearly visible to food employees.

6-301.20 Disposable Towels, Waste Receptacle.

A handwashing sink or group of adjacent handwashing sinks that is provided with disposable towels shall be provided with a waste receptacle as specified under 5-501.16(C).

6-302 Toilets and Urinals

6-302.10 Minimum Number.

Toilets and urinals shall be provided as specified under 5-203.12.

6-302.11 Toilet Tissue, Availability.

A supply of toilet tissue shall be available at each toilet. ^{Pf}

6-303 Lighting

6-303.11 Intensity.

The light intensity shall be:

- (A) At least ten (10) foot-candles (108 lux) at a distance of thirty (30) inches (75cm) above the floor, in walk-in refrigeration units and dry storage areas, and in other areas and rooms during periods of cleaning;
- (B) At least twenty (20) foot-candles (215 lux):
 - (1) At a surface where food is provided for customer self-service such as buffets and salad bars or where fresh produce or packaged foods are sold or offered for consumption;
 - (2) Inside equipment such as reach-in and under-counter refrigerators; and

(3) At a distance of thirty (30) inches (75 cm) above the floor in areas used for handwashing, warewashing, and equipment and utensil storage, and in toilet rooms; and

(C) At least fifty (50) foot-candles (540 lux) at a surface where a food employee is working with food or working with utensils or equipment such as knives, slicers, grinders, and saws where employee safety is a factor.

6-304 Ventilation

6-304.11 Mechanical.

If necessary to keep rooms free of excessive heat, steam, condensation, vapors, obnoxious odors, smoke, and fumes, mechanical ventilation of sufficient capacity shall be provided.

6-305 Dressings Areas and Lockers

6-305.11 Designation.

(A) Dressing rooms or dressing areas shall be designated if employees routinely change their clothes in the establishment.

(B) Lockers or other suitable facilities shall be provided for the orderly storage of employees' clothing and other possessions.

6-306 Service Sinks

6-306.10 Availability.

A service sink or curbed cleaning facility shall be provided as specified in 5-203.13(A).

6-4 LOCATION AND PLACEMENT

6-401 Handwashing Sinks

6-401.10 Conveniently Located.

Handwashing sinks shall be conveniently located as specified in 5-204.11.

6-402 Toilet Rooms

6-402.11 Convenience and Accessibility.

Toilet rooms shall be conveniently located and shall be accessible to employees during all hours of operation.

6-403 Employee Accommodations

6-403.11 Designated Areas.

(A) Areas designated for employees to eat, drink, and use tobacco shall be located so that food, equipment, linens, and single-service and single-use articles are protected from contamination.

(B) Lockers or other suitable facilities shall be located in a designated room or area where contamination of food, equipment, utensils, linens, and single-service or single-use articles can not occur.

6-404 Distressed Merchandise

6-404.11 Segregation and Location.

Products that are held by the permit holder for credit, redemption, or return to the distributor, such as damaged, spoiled, or recalled products, shall be segregated and held in designated areas that are separated from food, equipment, utensils, linens, and single-service and single-use articles. **PF**

6-405 Refuse, Recyclables, and Returnables

6-405.10 Receptacles, Waste Handling Units, and Designated Storage Areas.

Units, receptacles, and areas designated for storage of refuse and recyclable and returnable containers shall be located as specified under 5-501.19.

6-5 MAINTENANCE AND OPERATION

6-501 Premises, Structures, Attachments, and Fixtures - Methods

6-501.11 Repairing.

Physical facilities shall be maintained in good repair.

6-501.12 Cleaning, Frequency and Restrictions.

(A) Physical facilities shall be cleaned as often as necessary to keep them clean.

(B) Except for cleaning that is necessary due to a spill or other accident, cleaning shall be done during periods when the least amount of food is exposed, such as after closing.

6-501.13 Cleaning Floors, Dustless Methods.

(A) Except as specified in (B) of this section, only dustless methods of cleaning shall be used, such as wet cleaning, vacuum cleaning, mopping with treated dust mops, or sweeping using a broom and dust-arresting compounds.

(B) Spills or drippage on floors that occur between normal floor cleaning times may be cleaned:

(1) Without the use of dust-arresting compounds and

(2) In the case of liquid spills or drippage, with the use of a small amount of absorbent compound such as sawdust or diatomaceous earth applied immediately before spot cleaning.

6-501.14 Cleaning Ventilation Systems, Nuisance and Discharge Prohibition.

(A) Intake and exhaust air ducts shall be cleaned and filters changed so they are not a source of contamination by dust, dirt, and other materials.

(B) If vented to the outside, ventilation systems may not create a public health hazard, nuisance or unlawful discharge.

6-501.15 Cleaning Maintenance Tools, Preventing Contamination.

Food preparation sinks, handwashing sinks, and warewashing equipment may not be used for the cleaning of maintenance tools, the preparation or holding of maintenance materials, or the disposal of mop water and similar liquid wastes. ^{Pf}

6-501.16 Drying Mops.

After use, mops shall be placed in a position that allows them to air-dry without soiling walls, equipment, or supplies.

6-501.17 Absorbent Material on Floors, Use Limitation.

Except as specified in 6-501.13(B), sawdust, wood shavings, granular salt, baked clay, diatomaceous earth, or similar materials may not be used on floors.

6-501.18 Cleaning of Plumbing Fixtures.

Plumbing fixtures such as handwashing sinks, toilets, and urinals shall be cleaned as often as necessary to keep them clean.

6-501.19 Closing Toilet Room Doors.

Except during cleaning and maintenance operations, toilet room doors as specified under 6-202.14 shall be kept closed.

6-501.110 Using Dressing Rooms and Lockers.

(A) Dressing rooms shall be used by employees if the employees regularly change their clothes in the establishment.

(B) Lockers or other suitable facilities shall be used for the orderly storage of employee clothing and other possessions.

6-501.111 Controlling Pests.

The premises shall be maintained free of insects, rodents, and other pests. The presence of insects, rodents, and other pests shall be controlled to eliminate their presence on the premises by:

(A) Routinely inspecting incoming shipments of food and supplies;

(B) Routinely inspecting the premises for evidence of pests;

(C) Using methods, if pests are found, such as trapping devices or other means of pest control as specified under 7-202.12, 7-206.12, and 7-206.13; ^{Pf} and

(D) Eliminating harborage conditions.

6-501.112 Removing Dead or Trapped Birds, Insects, Rodents, and Other Pests.

Dead or trapped birds, insects, rodents, and other pests shall be removed from control devices and the premises at a frequency that prevents their accumulation, decomposition, or the attraction of pests.

6-501.113 Storing Maintenance Tools.

Maintenance tools such as brooms, mops, vacuum cleaners, and similar items shall be:

- (A) Stored so they do not contaminate food, equipment, utensils, linens, and single-service and single-use articles; and
- (B) Stored in an orderly manner that facilitates cleaning the area used for storing the maintenance tools.

6-501.114 Maintaining Premises, Unnecessary Items, and Litter.

The premises shall be free of:

- (A) Items that are unnecessary to the operation or maintenance of the establishment such as equipment that is nonfunctional or no longer used; and
- (B) Litter.

6-501.115 Prohibiting Animals.

(A) Except as specified in (B) and (C) of this section, live animals may not be allowed on the premises of a retail food establishment. **Pf**

(B) Live animals may be allowed in the following situations if the contamination of food, clean equipment, utensils, linens, and unwrapped single-service and single-use articles can not result:

- (1) Edible fish or decorative fish in aquariums, shellfish or crustacea on ice or under refrigeration, and shellfish and crustacea in display tank systems;
- (2) Patrol dogs accompanying police or security officers in offices, dining, sales, and storage areas, and sentry dogs running loose in outside fenced areas;
- (3) In areas that are not used for food preparation and that are usually open for customers, such as dining and sales areas, service animals as defined by the *Americans with Disabilities Act* that are controlled by the disabled employee or person, if a health or safety hazard will not result from the presence or activities of the service animal;

(4) Pets in the common dining areas of institutional care facilities such as nursing homes, assisted living facilities, group homes, or residential care facilities at times other than during meals if:

- (a) Effective partitioning and self-closing doors separate the common dining areas from food storage or food preparation areas,
- (b) Condiments, equipment, and utensils are stored in enclosed cabinets or removed from the common dining areas when pets are present, and
- (c) Dining areas including tables, countertops, and similar surfaces are effectively cleaned before the next meal service; and

(5) In areas that are not used for food preparation, storage, sales, display, or dining, in which there are caged animals or animals that are similarly confined, such as in a variety store that sells pets or a tourist park that displays animals.

(C) Live or dead fish bait may be stored if contamination of food, clean equipment, utensils, linens, and unwrapped single-service and single-use articles cannot result.

Chapter 7 Poisonous or Toxic Materials

7-1 LABELING AND IDENTIFICATION

7-101 Original Containers

7-101.11 Identifying Information, Prominence.

Containers of poisonous or toxic materials and personal care items shall bear a legible manufacturer's label. **Pf**

7-102 Working Containers

7-102.11 Common Name.

Working containers used for storing poisonous or toxic materials such as cleaners and sanitizers taken from bulk supplies shall be clearly and individually identified with the common name of the material. **Pf**

7-2 OPERATIONAL SUPPLIES AND APPLICATION

7-201 Storage

7-201.11 Separation.

Poisonous or toxic materials shall be stored so that they cannot contaminate food, equipment, utensils, linens, and single-service and single-use articles by:

(A) Separating the poisonous or toxic materials by spacing or partitioning; **P** and

(B) Locating the poisonous or toxic materials in an area that is not above food, equipment, utensils, linens, and single-service and single-use articles. This paragraph does not apply to equipment and utensil cleaners and sanitizers that are stored in warewashing areas for availability and convenience if the materials are stored to prevent contamination of food, equipment, utensils, linens, and single-service and single-use articles **P**

7-202 Presence and Use

7-202.11 Restriction.

(A) Only those poisonous or toxic materials that are required for operation and maintenance of the retail food establishment, such as for the cleaning and sanitizing of equipment and utensils and the control of insects and rodents, shall be allowed in a retail food establishment. **PF**

(B) This requirement does not apply to packaged poisonous or toxic materials and medicines that are offered for retail sale.

7-202.12 Conditions of Use.

Poisonous or toxic materials shall be:

(A) Used according to:

- (1) Law and this regulation, and
- (2) Manufacturer's use directions included in labeling, and, for a pesticide, manufacturer's label instructions that state that use is allowed in a retail food establishment, and **P**
- (3) The conditions of certification, if certification is required, for use of the pest control materials, **P** and
- (4) Additional conditions that may be established by the Department; and

(B) Applied so that:

- (1) A hazard to employees or other persons is not constituted, **P** and
- (2) Contamination including toxic residues due to drip, drain, fog, splash, or spray on food, equipment, utensils, linens, and single-service and single-use articles is prevented by and for a restricted use pesticide; this is achieved by: **P**
 - (a) Removing the items, **P**
 - (b) Covering the items with impermeable covers, **P** or
 - (c) Taking other appropriate preventive actions, **P** and
 - (d) Cleaning and sanitizing equipment and utensils after the application. **P**

(C) A restricted use pesticide shall be applied only by an applicator certified as defined in 7 USC 136, *Definitions, (e) Certified Applicator, of the Federal Insecticide, Fungicide, and Rodenticide Act*, or a person under the direct supervision of a certified applicator. **PF**

7-203 Container Prohibitions

7-203.11 Chemical, Poisonous, or Toxic Material Containers.

A container previously used to store chemicals, including poisonous or toxic materials, may not be used to store, transport, or dispense food. **P**

7-204 Chemicals

7-204.11 Sanitizers, Criteria.

Chemical sanitizers, including chemical sanitizing solutions generated on-site, and other chemical antimicrobials applied to food-contact surfaces shall:

(A) Meet the requirements specified in 40 CFR 180.940, *Tolerance Exemptions for Active and Inert Ingredients for use in Antimicrobial Formulations (Food-Contact Surface Sanitizing Solutions)*, ^P or

(B) Meet the requirements as specified in 40 CFR 180.2020, *Pesticide Chemicals Not Requiring a Tolerance or Exemption from Tolerance-Non-Food Determinations*.^P

7-204.12 Chemicals for Washing, Treatment, Storage, and Processing Fruits and Vegetables.

Chemicals, including those generated on-site, used to wash or peel raw, whole fruits and vegetables or used in the treatment, storage, and processing of fruits and vegetables shall:

(A) Be an approved food additive listed for this intended use in 21 CFR 173, ^P or

(B) Be generally recognized as safe (GRAS) for this intended use, ^P or

(C) Be the subject of an effective food contact notification for this intended use (only effective for the manufacturer or supplier identified in the notification), ^P and

(D) Meet the requirements in 40 CFR 156 *Labeling Requirements for Pesticide and Devices*. ^P

7-204.13 Boiler Water Additives, Criteria.

Chemicals used as boiler water additives shall meet the requirements specified in 21 CFR 173.310, *Boiler Water Additives*. ^P

7-204.14 Drying Agents Criteria.

Drying agents used in conjunction with sanitization shall:

(A) Contain only components that are listed as one of the following:

(1) Generally recognized as safe for use in food as specified in 21 CFR 182, *Substances Generally Recognized as Safe*, or 21 CFR 184, *Direct Food Substances Affirmed as Generally Recognized as Safe*; ^P

(2) Generally recognized as safe for the intended use as specified in 21 CFR 186, *Indirect Food Substances Affirmed as Generally Recognized as Safe*; ^P

(3) Generally recognized as safe for the intended use as determined by experts qualified in scientific training and experience to evaluate the safety of substances added, directly or indirectly, to food as described in 21 CFR 170.30, *Eligibility for Classification as Generally Recognized as Safe (GRAS)*; ^P

(4) Subject of an effective *Food Contact Notification* as described in the *Federal Food Drug and Cosmetic Act (FFDCA)* Section 409(h); ^P

(5) Approved for use as a drying agent under a prior sanction as described in the *Federal Food Drug and Cosmetic Act (FFDCA)* 201(s)(4); ^P

(6) Specifically regulated as an indirect food additive for use as a drying agent as specified in 21 CFR Parts 174 through 178; ^P or

(7) Approved for use as a drying agent under the threshold of regulation process established by 21 CFR 170.39, *Threshold of regulation for substances used in food-contact articles*; ^P and

(B) When sanitization is with chemicals, the approval required under (A)(5) or (A)(7) of this section or the regulation as an indirect food additive required under (A)(6) of this section shall be specifically for use with chemical sanitizing solutions. ^P

7-205 Lubricants

7-205.11 Incidental Food Contact, Criteria.

Lubricants shall meet the requirements specified in 21 CFR 178.3570, *Lubricants with Incidental Food Contact*, if they are used on food contact surfaces, on bearings and gears located on or within food contact surfaces, or on bearings and gears that are located so that lubricants may leak, drip, or be forced into food or onto food contact surfaces. ^P

7-206 Pesticides

7-206.11 Restricted Use Pesticides, Criteria.

Restricted use pesticides specified in 7-202.12(C) shall meet the requirements specified in 40 CFR 152, Subpart I, *Classification of Pesticides*. ^P

7-206.12 Rodent Bait Stations.

Rodent bait shall be contained in a covered, tamper-resistant bait station. ^P

7-206.13 Tracking Powders, Pest Control, and Monitoring.

(A) Except as specified in (B) of this section, a tracking powder may not be used in retail food establishments. **P**

(B) If used, a nontoxic tracking powder, such as talcum or flour, may not contaminate food, equipment, utensils, linens, and single-service and single-use articles.

7-207 Medicines

7-207.11 Restriction and Storage.

(A) Except for medicines that are stored or displayed for retail sale, only those medicines that are necessary for the health of employees shall be allowed in a retail food establishment. **Pf**

(B) Medicines that are in a retail food establishment for the employees' use shall be labeled as specified under 7-101.11 and located to prevent the contamination of food, equipment, utensils, linens, and single-service and single-use articles. **P**

7-207.12 Refrigerated Medicines, Storage.

Medicines belonging to employees or to children in a day care center that require refrigeration and are stored in a food refrigerator shall be:

(A) Stored in a package or container and kept inside a covered, leakproof container that is identified as a container for the storage of medicines; **P** and

(B) Located so they are inaccessible to children. **P**

7-208 First Aid Supplies

7-208.11 Storage.

First aid supplies that are in a retail food establishment for the employees' use shall be:

(A) Labeled as specified under 7-101.11 **Pf** and

(B) Stored in a kit or a container that is located to prevent the contamination of food, equipment, utensils, linens, and single-service and single-use articles. **P**

7-209 Other Personal Care Items

7-209.11 Storage.

Except as specified under 7-207.12 and 7-208.11, employees shall store their personal care items in facilities as specified under 6-305.11(B).

7-3 STOCK AND RETAIL SALE

7-301 Storage and Display

7-301.11 Separation.

Poisonous or toxic materials shall be stored and displayed for retail sale so they cannot contaminate food, equipment, utensils, linens, and single-service and single-use articles by:

(A) Separating the poisonous or toxic materials by spacing or partitioning **P** and

(B) Locating the poisonous or toxic materials in an area that is not above food, equipment, utensils, linens, and single-service or single-use articles. **P**

Chapter 8 Compliance and Enforcement

8-1 REGULATION APPLICABILITY

8-101 Use for Intended Purpose

8-101.10 Public Health Protection.

Retail food establishments in operation prior to the effective date of this regulation and in compliance with the previous regulation, but which do not fully comply with all the construction, equipment, and physical requirements of this regulation, shall be deemed acceptable provided the facilities and equipment:

(A) Are capable of being maintained in a sanitary condition;

(B) Are not a public health hazard or nuisance; and

(C) Are replaced in the normal course of operation with equipment and facilities that meet the requirements of this regulation.

(D) This section shall not apply to equipment installed or construction begun after the effective date of this regulation.

8-102 Additional Requirements

8-102.10 Preventing Health Hazards, Provision for Conditions Not Addressed.

(A) If necessary to protect against public health hazards or nuisances, the Department may impose specific requirements that are authorized by law in addition to the requirements contained in this regulation.

(B) The Department shall document the conditions that necessitate the imposition of additional requirements and the underlying public health rationale. The documentation shall be provided to the permit applicant or permit holder and a copy shall be maintained in the Department file for the retail food establishment.

8-103 Variances

8-103.10 Modifications and Waivers.

(A) The Department may grant a variance by modifying or waiving the requirements of this regulation if, in the opinion of the Department, a health hazard or nuisance will not result from the variance. If a variance is granted, the Department shall retain the information specified under 8-103.11 in its records for the retail food establishment.

(B) When a retail food establishment desires to use a construction procedure inconsistent with the regulation or use materials and/or equipment other than specified in this regulation, a variance may be requested from the Department. Such a request must:

- (1) Be submitted in writing,
- (2) Include a description of the material(s), equipment, and/or construction procedure(s) proposed, and
- (3) Identify the material, equipment and/or procedure required by the regulation, and include proof of equivalency.

(C) The Department shall only consider a complete request for approval of a variance. The Department's decision on such a variance will be final.

8-103.11 Documentation of Proposed Variance and Justification.

Before a variance from a requirement of this regulation is approved, the information provided by the retail food establishment requesting the variance and retained in the Department's file shall include:

(A) A statement of the proposed variance of this regulation requirement citing relevant regulation section(s);^P

(B) An analysis of the rationale for how the potential public health hazards and nuisances addressed by the relevant regulation sections will be alternatively addressed by the proposal; ^P and

(C) A HACCP plan if required as specified under 8-201.13(A) that includes the information specified under 8-201.14 as it is relevant to the variance requested. ^{Pf}

8-103.12 Conformance with Approved Procedures.

If the Department grants a variance as specified in 8-103.10 or a HACCP plan is otherwise required as specified under 8-201.13, the permit holder shall:

(A) Comply with the HACCP plans and procedures that are submitted as specified under 8-201.14 and approved as a basis for the modification or waiver; ^P and

(B) Maintain and provide to the Department, upon request, records specified under 8-201.14(D) and (E) that demonstrate that the following are routinely employed:

- (1) Procedures for monitoring the critical control points, ^{Pf}
- (2) Monitoring of the critical control points, ^{Pf}
- (3) Verification of the effectiveness of the operation or process, ^{Pf} and
- (4) Necessary corrective actions if there is failure at a critical control point. ^{Pf}

8-2 PLAN SUBMISSION AND APPROVAL

8-201 Operating Plans

8-201.13 When a HACCP Plan is Required.

(A) Before engaging in an activity that requires a HACCP plan, a permit applicant or permit holder shall submit to the Department for approval a properly prepared HACCP plan as specified under 8-201.14 and the relevant provisions of this regulation if:

- (1) Submission of a HACCP plan is required by a section of this regulation;
- (2) A variance is required as specified under 3-401.11(D)(4) and 3-502.11;
- (3) The Department determines that a food preparation or processing method requires a variance based on a plan submittal, an inspectional finding, or a variance request.

(B) Before engaging in reduced oxygen packaging without a variance as specified under 3-502.12, a permit applicant or permit holder shall submit a properly prepared HACCP plan to the Department.

8-201.14 Contents of a HACCP Plan.

For a retail food establishment that is required under 8-201.13 to have a HACCP plan, the permit applicant or permit holder shall submit to the Department a properly prepared HACCP plan that includes:

(A) The name of the permit applicant or permit holder, the retail food establishment address, and contact information;

(B) A categorization of the types of time/temperature control for safety foods that are to be controlled under the HACCP plan; **Pf**

(C) A flow diagram or chart for each specific food or category type that identifies:

- (1) Each step in the process; **Pf**
- (2) The hazards and controls for each step in the flow diagram or chart; **Pf**
- (3) The steps that are critical control points; **Pf**
- (4) Ingredients, materials, and equipment used in the preparation of that food; **Pf** and
- (5) Formulations or recipes that delineate methods and procedural control measures that address the food safety concerns involved. **Pf**

(D) A critical control points summary for each specific food or category type that clearly identifies:

- (1) Each critical control point, **Pf**
- (2) The critical limits for each critical control point, **Pf**
- (3) The method and frequency for monitoring and controlling each critical control point by the food employee designated by the person in charge, **Pf**
- (4) The method and frequency for the person in charge to routinely verify that the food employee is following standard operating procedures and monitoring each critical control point, **Pf**
- (5) Action to be taken by the designated food employee or person in charge if the critical limits for each critical control point are not met, **Pf** and
- (6) Records to be maintained by the person in charge to demonstrate that the HACCP plan is properly operated and managed; **Pf** and

(E) Supporting documents including:

- (1) Food employee and supervisory training plan that addresses the food safety issues of concern; **Pf**
- (2) Copies of blank record forms that are necessary to implement the HACCP plan; **Pf** and
- (3) Additional scientific data or other information, as required by the Department, supporting the determination that food safety is not compromised by the proposal; **Pf** and

(F) Any other information required by the Department.

8-203 Construction Inspection and Approval

8-203.10 Preoperational Inspections.

The Department shall conduct preoperational inspection(s) to verify that the retail food establishment is constructed and equipped in accordance with this regulation. The permit holder or representative of the permit holder must request the preoperational inspection fourteen (14) days prior to an inspection to issue a permit.

8-3 PERMIT TO OPERATE

8-301 Requirement

8-301.11 Prerequisite for Operation.

(A) No person shall operate a retail food establishment without a valid permit to operate issued by the Department. Pf

(B) Only a person who complies with the requirements of this regulation shall be entitled to receive and retain such a permit.

(C) The permit shall be kept in the retail food establishment and shall be accessible at all times.

8-301.12 Retail Food Establishment Permits Not Required.

(A) The following establishments shall not be required to have a permit from the Department:

(1) Churches or charitable organizations where the food service is limited to members and their invited guests.

(2) Churches or charitable organizations who prepare and serve food to the public on their own premises at one function a month or not more than twelve functions a year.

(3) Food service such as soup kitchens and food banks operated by organizations that are providing food at no cost and not for profit or gain to the public who are in need of food assistance.

(4) A bed and breakfast with 10 or fewer rental rooms and a residential kitchen that provides food service.

(5) Retail food establishments or facilities located on United States Government property and regulated by federal authorities.

(6) Retail food establishments or facilities operated by the United States Government.

(7) Retail food establishments or facilities serving solely as commissaries for interstate carriers.

(8) Retail food establishments or facilities on vehicles or common carriers for hire such as airplanes, trains (including maintenance crew cook cars), ships, and other similar conveyances.

(9) Retail food establishments or facilities governed by other regulations when such regulations are determined by the Department to be satisfactory.

(10) Food from retail food establishments outside the jurisdiction of the Department or the State of South Carolina which is sold within the State of South Carolina if such retail food establishments conform to the provisions of this regulation or to substantially equivalent provisions. To determine the extent of compliance with such provisions, the Department may accept reports from responsible authorities in other jurisdictions where such retail food establishments are located.

(11) Bake sales operated by churches or charitable organizations where homemade cakes, breads, and cookies may be offered for sale only if they are not time/temperature control for safety foods.

(12) Home Based Food Production Operations, which prepare non-time/temperature control for safety foods, such as homemade cakes, breads, cookies, and candy, in a private residence kitchen for sale directly to the end consumer.

(13) Boarding houses which provide room and board, which restrict food service to residents only, and do not provide food service to the non-renting public.

(14) Hunt lodges and outdoor-adventure tours that provide room and board as part of a package, and food service is restricted to participants only.

(15) Motels and hotels that prepare non-time/temperature control for safety food breakfast foods or serve pre-packaged food.

(16) Taverns that are primarily engaged in the sale of alcoholic beverages and do not engage in the preparation of food.

(17) Cooking schools or classes where registered students are active participants in preparing the food and are the exclusive consumers of the foods prepared.

(18) Personal chefs that are employed to cook for the owner and occupants of a private residence and their guests. A personal chef may purchase the food and shall prepare, cook and serve the food at the private residence only.

(19) Businesses that serve the following non-time/temperature control for safety foods that use a low risk food process:

- (a) Popcorn, cotton candy, candy apples;
- (b) Sno-cones or shaved ice;
- (c) Soft drinks or beverages;
- (d) Nachos served with heated cheese product;
- (e) Commercially dehydrated pre-packaged pork skins;
- (f) Pre-formed or prepared pretzels that require baking or warming only; or
- (g) Other Department-approved non-time/temperature control for safety foods that use a low risk food process.

(20) An individual, operating out of the individual's dwelling, who prepares and sells the following non-time/temperature control for safety foods that use a low risk food process:

- (a) Jams, jellies, preserves, and dried fruits
- (b) Dry herbs, seasonings, and mixtures
- (c) Vinegar and flavored vinegars
- (d) Other Department-approved non-time/temperature control for safety foods that use a low risk food process.

The preparation and sale of food items which present a food safety risk such as acidified foods, low acid canned foods, garlic in oil, and fresh fruit or vegetable juices are not exempt from permitting under this provision.

(21) Businesses that serve the following low risk food processes of time/temperature control for safety foods:

- (a) Coffee or coffee based beverages served with pasteurized milk or cream prepared and served either heated or cold.
- (b) Beverages individually prepared upon consumer's request from a commercially pre-packaged powdered mix with no additional ingredients that are time/temperature control for safety foods, and served in a single service cup;
- (c) Commercially pre-packaged, pre-cut frozen french fries;
- (d) Salt boiled peanuts;
- (e) Boiled or grilled corn;
- (f) Snow cones or shaved ice served with pasteurized cold milk or cream from a non-reusable container;
- (g) Waffle or pancake mix that is commercially pre-packaged and dispensed from self-serve units for service not to exceed four (4) hours in duration. Leftover portions of these products shall be discarded at the end of service; and
- (h) Funnel cakes, minidonuts, or similar type products prepared from a single unit having no more than three fryers. Mixed batters shall not be held out of temperature more than four (4) hours. Leftover portions of these products shall be discarded at the end of service.

For the purpose of 8-301.12(A)(21), the low risk food processes of time/temperature control for safety foods shall not include meat, poultry, fish, or game animals.

(22) Convenience stores or other businesses that offer for sale only pre-packaged food from a food processing plant.

(23) Vending machines that provide only pre-packaged food from a food processing plant.

(B) The Department may require a facility to submit information sufficient to determine if the facility is exempt from the permit requirement or must apply for and obtain a retail food establishment permit. This information may include, but is not limited to, designation of charitable status, leases or proof of ownership, equipment specifications, menus, ingredient lists, food packaging, and food preparation methods.

(C) Although the establishments listed in 8-301.12(A) do not require a permit, the Department retains the authority to conduct an investigation in response to a complaint. The Department may require corrective action and issue orders as deemed necessary in response to food safety or health risks identified during the investigation.

8-302 Application Procedure

8-302.11 Submission Thirty (30) Calendar Days Before Proposed Opening.

An applicant shall submit a complete application for a permit at least thirty (30) calendar days before the date planned for opening a retail food establishment except as specified in 8-303.20(A)(1).

8-302.12 Form of Submission.

A person desiring to operate a retail food establishment shall submit to the Department a written application for a permit on a form provided by the Department.

8-302.13 Qualifications and Responsibilities of Applicants.

To qualify for a permit, an applicant shall:

(A) Be an owner of the proposed retail food establishment or an officer of the legal entity owning the proposed retail food establishment;

(B) Comply with the requirements of this regulation;

(C) As specified under 8-402.11, agree to allow access to the retail food establishment and to provide required information; and

(D) Pay the applicable Initial Permit/First Year Operational fee of one hundred dollars (\$100.00) plus the applicable annual inspection fee for the anticipated gross sales of food and food products as identified in the table in section 8-304.11(A)(3) at the time the application is submitted. The fee shall be paid prior to the issuance of the permit.

8-302.14 Contents of the Application.

(A) The following application documentation shall be submitted as part of the application process:

(1) A complete retail food establishment application and any applicable supplement form(s);

(2) Menu or list of foods to be served;

(3) Anticipated volume of food to be stored, prepared, and sold or served;

(4) Approval of variances;

(5) Verification of approved drinking water supply;

(6) Verification of approved method of sewage disposal;

(7) Documentation that the construction of this facility meets the standards set forth in this regulation and all other applicable regulations and codes;

(8) For new facilities, based on facility type, proposed layout, mechanical schematics, construction materials, and finish schedules to comply with the applicable sections of the regulation;

(9) For new facilities, based on facility type, proposed equipment types, manufacturers, model numbers, locations, dimensions, performance capacities, and installation specifications to comply with the applicable sections of the regulation;

(10) Documentation of completed training if required.

(B) Only when an application has been submitted, is considered complete, and the applicable inspection fee has been paid, may the applicant request a preoperational inspection for the proposed retail food establishment.

(C) If at any time during the preoperational inspection the information provided during the application process changes or is altered, the Department may require a new application to be submitted.

(D) The Department shall not issue a permit until the facility is in full compliance with the requirements of this regulation.

(E) The Department may deny a new permit based on past compliance or enforcement history.

8-303 Issuance

8-303.10 New, Converted, or Remodeled Establishments.

The Department shall issue a permit to the applicant only after the following are submitted or completed:

(A) A properly completed application;

(B) Documentation that the construction of this facility meets the standards set forth in this regulation and all other applicable regulations and codes; and

(C) A preoperational inspection as specified in 8-203.10 shows that the establishment is built or remodeled in accordance with this regulation.

8-303.20 Existing Establishments and Change of Ownership.

(A) Routine Change of Ownership.

(1) When a retail food establishment is in the process of changing ownership, the Department shall be notified immediately.

(2) Within fifteen (15) calendar days from the date of the change of ownership, the new owner shall submit a complete application for a new permit as required in 8-302.12 and pay applicable Department fees as provided in 8-302.13(D).

(3) The Department shall review the application for a change of ownership, and

(a) If the Department determines, pursuant to 8-304.11, the new owner is making changes to the existing permit operations, the change of ownership protocol shall not apply; and

(b) The retail food establishment shall then be subject to all requirements of 8-303.10; and

(c) The facility may be required to close while changes to the facility are evaluated for compliance with the requirements of the regulation. Failure to cease operations and close the facility as required by the Department during evaluation of changes to existing permit operations will constitute operation of a retail food establishment without a permit in violation of this regulation. The facility must remain closed unless and until a new permit is issued to the facility.

(4) Upon receipt of a complete application, the Department will conduct an inspection to determine compliance with Regulation 61-25. A permit shall not be issued to a retail food establishment for a change of ownership if:

(a) The retail food establishment has conditions that constitute an imminent health hazard;

(b) Has any priority or priority foundation violations; or

(c) Has a score of 87 or below.

(5) If the new owner fails to submit a complete and timely application, fails to pay applicable fees under (A)(2) of this section, or fails to obtain compliance at the permit inspection under (A)(4)(a) of this section, the retail food establishment shall cease and close all food operations immediately. Any continued operation of the facility will constitute operation of a retail food establishment without a permit in violation of this regulation. The facility must remain closed until a new permit is issued to the facility.

(6) If the new owner fails to obtain compliance at the permit inspection under (A)(4)(b) or (A)(4)(c), the retail food establishment may continue food operations for a time period not to exceed fifteen (15) calendar days. The retail food establishment must obtain compliance at a follow-up permit inspection during the fifteen (15) day period. If the new owner fails to obtain compliance within the fifteen (15) day period, the retail food establishment shall cease and close all food operations immediately. Any continued operation of the facility will constitute operation of a

retail food establishment without a permit in violation of this regulation. The facility must remain closed until a new permit is issued to the facility.

(7) Within ninety (90) calendar days of the permitted change of ownership, the retail food establishment shall be in full compliance with 5-103.11, 5-203.11, 5-203.13, and 5-204.12 of this regulation.

(a) Failure to comply with this requirement will result in permit suspension and

(b) The permit will then remain suspended until the retail food establishment obtains full compliance with all parts of this regulation.

(B) Change of Ownership in Facilities under Enforcement Action.

(1) Retail food establishments under enforcement action are not eligible for a change of ownership protocol as stated in section (A) above.

(2) A person who wants to take ownership of a retail food establishment under enforcement action shall apply for a new permit and shall provide documentation that demonstrates a bona fide change of ownership. This documentation includes, but is not limited to, a bill of sale for the business, a new lease or bill of sale for the building, a new business or liquor license, or applications for these licenses in the new owner's name, and documentation of management and staffing changes the new owner proposes.

(3) If the Department determines that the change of ownership is bona fide, the Department shall notify the new owner in writing that the retail food establishment is subject to a pending enforcement action and that any and all actions necessary to satisfy the enforcement action must be completed before the Department will issue a permit to the new applicant.

(4) If the Department determines that the change of ownership is not bona fide, the Department shall return the permit application and the inspection fee to the applicant and shall notify the applicant in writing that the retail food establishment is subject to a pending enforcement action and that any and all actions necessary to satisfy the enforcement action must be completed before the Department will process an application for a new permit.

8-303.30 Denial of Application for Permit, Notice.

If an application for a permit to operate is denied, the Department shall provide the applicant with a notice that includes:

(A) The specific reasons and regulation citations for the permit denial;

(B) The actions, if any, that the applicant must take to qualify for a permit.

8-304 Conditions of Retention

8-304.10 Responsibilities of the Department.

(A) At the time a permit is first issued, the permit holder shall demonstrate access to a copy of this regulation and that the permit holder is knowledgeable of the compliance requirements and the conditions of retention, as specified under 8-304.11, that are applicable to the permit.

(B) Failure to provide the information specified in (A) of this section does not prevent the Department from taking authorized action or seeking remedies if the permit holder fails to comply with this regulation or an order, warning, or directive of the Department.

8-304.11 Requirement to Comply with Regulation and Conditions of Permit.

(A) Once a permit has been issued by the Department, the permit holder, in order to retain the permit, shall:

(1) Comply with the provisions of this regulation and all terms and conditions stated on the permit document;

(2) As specified under 8-402.11, agree to allow the Department access to the retail food establishment and to provide required information; and

(3) Pay to the Department annual inspection fees as follows:

(a) Annually, each retail food establishment shall determine and pay to the Department the applicable inspection fee, based on the gross sales of food and food products for the facility's previous business year, using the table below. As provided in 8-302.13(D), a person or facility applying for an Initial/First Year Operational Permit or change of ownership for a retail food

establishment shall determine and pay to the Department the applicable inspection fee using the table below, based on anticipated gross sales of food and food products during the facility's first year of operations. Payment shall be due thirty (30) days from the Department billing date. A penalty charge of fifty dollars (\$50.00) shall be assessed for fees that are thirty (30) days past due. A second penalty charge of fifty dollars (\$50.00) shall be assessed for fees that are sixty (60) days past due. Permit holders of retail food establishments shall furnish previous business year sales information upon request of the Department. This information shall be exempt from disclosure pursuant to the South Carolina Freedom of Information Act, S.C. Code Section 30-4-40(a)(2).

Sales	Fee
\$0-\$250,000	\$100.00
\$250,000 - \$500,000	\$150.00
\$500,000- \$750,000	\$200.00
\$750,000- \$1,000,000	\$250.00
\$1,000,000 - \$1,250,000	\$300.00
\$1,250,000 - \$1,500,000	\$350.00
\$1,500,000 - \$1,750,000	\$400.00
\$1,750,000 and above	\$450.00

(b) Failure to meet the requirements of 8-304.11(A)(3)(a) will result in initial permits not being issued or existing permits being suspended. Retail food establishments that have not paid their inspection fee and late payment penalties after ninety (90) days from the original billing date shall have their permit suspended following service of notice of suspension. The Department may reinstate a permit suspended for failure to pay renewal fees upon payment of the fees, penalties, and a \$25.00 reinstatement fee.

(c) The following retail food establishments shall be exempt from fees:

(i) Retail food establishments that are operated by a public or private school (kindergarten through grade twelve) or that are operated by a child care facility that is licensed and inspected by the Department of Social Services.

(ii) Retail food establishments operated by health care facilities that are regulated and inspected by the Department.

(iii) Retail food establishments operated by other state agencies or local governments that provide food for patients, clients, or inmates.

(iv) Retail food establishments operated by non-profit organizations for the purpose of providing meals or food to needy persons at little or no cost, or for the purpose of raising money for a charitable cause. Non-profit organizations claiming exemption from fee charges shall certify annually to the Department that the organization meets these criteria and, upon request, provide documentation supporting any such certification.

(4) Have access to and knowledge of this regulation. Copies may be viewed on the Department website.

(5) Operate as a retail food establishment (serve or sell food) for no less than fifteen (15) consecutive days annually, or be in operation for at least one (1) day a week for no less than fifteen (15) weeks annually.

(B) The Department shall be notified prior to any retail food establishment changes including, but not limited to, the following items:

- (1) Location;
- (2) Service or seating capacity;
- (3) Drinking water or sewage disposal provider;
- (4) Change of hot water generation and distribution system(s);
- (5) Change of ownership;
- (6) Permanent closure;

- (7) Installation of equipment and/or structural modifications;
- (8) A corrected billing or mailing address within ten (10) calendar days of any change of address;
- (9) Shared use operations capacity.

(C) The Department shall be notified prior to adding a food item to the menu that:

- (1) Involves a food preparation process which may consist of cooking, cooling, or reheating food which was not performed in the retail food establishment or
- (2) Poses a health risk to consumers because it is a raw animal food served raw or undercooked.

(D) Once the Department is notified or becomes aware of changes under (B) or (C) of this section, the Department may amend the permit and may require additional changes as required by this regulation.

(E) Any change under (B) or (C) of this section, not previously approved or authorized by the Department, may subject the retail food establishment to enforcement action, including, but not limited to, civil penalties, permit suspension, permit revocation, or a combination of these.

8-304.20 Permits Not Transferable.

A permit may not be transferred:

- (A) From one person or legal entity to another person or legal entity,
- (B) From one retail food establishment to another, or
- (C) From one type of operation to another if the food operation changes from the type of operation specified in the application and the change in operation is not approved or authorized.

8-4 INSPECTION AND CORRECTION OF VIOLATIONS

8-402 Access

8-402.11 Access.

(A) The Department staff, after proper identification, shall be allowed to enter any retail food establishment at any time the establishment is occupied for the purpose of making an announced, unannounced, or complaint inspection(s) to determine compliance with this regulation.

(B) The Department staff shall be allowed to examine all areas of the facility and all records of the retail food establishment to obtain information pertaining to equipment, food, or supplies purchased, received, or used.

8-402.20 Refusal, Notification of Right to Access, and Final Request for Access.

If a person denies access to the Department, the Department shall inform the person that:

(A) The permit holder is required to allow access by Department as specified under 8-402.11 of this regulation,

(B) Access is a condition of the acceptance and retention of a retail food establishment permit to operate as specified under 8-304.11, and

(C) If access is denied, the Department may issue an order for access pursuant to 8-402.11, obtain a warrant, or pursue access as allowed by other applicable laws.

8-402.30 Refusal, Reporting.

If after the Department presents credentials as specified under 8-402.11, explains the authority upon which access is required, and the person in charge continues to refuse access, the Department shall provide details of the denial of access on an inspection report form.

8-402.40 Order to Gain Access.

If, after an order has been issued by the Department pursuant to 8-402.20(C), the Department is denied access to a retail food establishment for an authorized purpose, the Department may initiate enforcement action including assessment of civil penalties, permit suspension, and/or permit revocation as provided in 8-904.110 and 8-913.10.

8-403 Report of Findings

8-403.10 Documenting Information and Observations.

(A) The findings shall be recorded on the inspection report, and upon completion of the inspection, the weighted sum of the items in violation shall be totaled and subtracted from one hundred (100) to determine the numerical score.

(B) The Department may use whatever means necessary to record violations, including, but not limited to, electronic inspection programs, manual inspection forms, photographs, video, and printed materials.

(C) Grades of permitted retail food establishments shall be as follows:

(1) Grade A - A permitted retail food establishment having a rating score of eighty-eight to one hundred (88–100) points.

(2) Grade B - A permitted retail food establishment having a rating score of seventy eight to eighty seven (78–87) points.

(3) Grade C - A permitted retail food establishment having a rating score of seventy-seven (77) or less points.

(D) Immediately following each inspection, the Department shall post the appropriate grade decal in the retail food establishment, and shall furnish a copy of the completed inspection report to the permit holder, person in charge, or an employee of the retail food establishment.

(E) A grade decal shall be posted by the Department in a location that is conspicuous to consumers. The retail food establishment shall not obscure, cover, deface, relocate, or remove the posted grade decal.

(F) Notwithstanding the grade criteria established in (C) of this section, when a consecutive violation is discovered, the Department may:

(1) Schedule appropriate follow-up inspections as specified in 8–405.11; or

(2) Downgrade the retail food establishment to the next lower grade; or

(3) Suspend the permit.

(G) Notwithstanding the grade criteria established in (C) of this section, there are circumstances and conditions under which the grade decal posted may differ from the numerical score of the inspection report:

(1) When the retail food establishment is under enforcement action; or

(2) When the retail food establishment has a consecutive violation(s).

(3) When, in accordance with S.C. Code Ann. Section 1–23–370, the retail food establishment is under the following pending enforcement actions,

(a) Imminent health hazard,

(b) Permit suspension, or

(c) Permit revocation.

(H) The permit holder or operator of any retail food establishment in which the grade has been lowered may request an inspection for the purpose of re-grading the retail food establishment. The request shall include a signed statement by the permit holder, person in charge, or employee that all violations have been corrected. The Department shall respond to the request within ten (10) calendar days.

8–403.20 Specifying Time Frame for Corrections.

The Department shall specify on the inspection report form the time frame for correction of the violations as specified under 8–404.11 and 8–405.11.

8–403.30 Issuing Report and Obtaining Acknowledgment of Receipt.

A copy of the completed inspection report form shall be furnished to the permit holder, person in charge, or an employee at the conclusion of the inspection. The report may be furnished in either electronic or printed form.

8–403.40 Refusal to Sign Acknowledgement.

The Department shall inform a person who declines to sign an acknowledgment of receipt of inspectional findings as specified in 8–403.30 that:

- (A) An acknowledgment of receipt is not an agreement with findings;
- (B) Refusal to sign an acknowledgment of receipt will not affect the permit holder's obligation to correct the violations noted in the inspection report within the time frames specified; and
- (C) Refusal to sign an acknowledgment of receipt is noted in the inspection report and maintained in the Department's record for the retail food establishment.

8-403.50 Public Information.

The Department shall treat inspection reports as public documents and shall make them available for disclosure to persons upon request as provided in law.

8-404 Imminent Health Hazard

8-404.11 Imminent Health Hazard.

(A) The Department, without prior notice or hearing, may suspend the permit to operate a retail food establishment when it is determined that the operation of the retail food establishment constitutes an imminent health hazard to public health except as specified under (E) of this section. **P**

(B) Following permit suspension due to an imminent health hazard, all food service operations shall immediately cease.

(C) The Department shall promptly notify, in writing, the permit holder, person in charge, or an employee of the specific reasons for which the permit was suspended.

(D) A retail food establishment may voluntarily close prior to the Department declaring an imminent health hazard but shall remain closed until authorized by the Department to resume operations.

(E) A permit holder may continue operations in areas of the establishment that are unaffected by the imminent health hazard.

(F) Considering the nature of the potential hazard involved and the complexity of the corrective action needed, the Department may, but is not required to, agree to continuing operations in the event of an extended interruption of electrical or water service if:

- (1) A written emergency operating plan has been approved by the Department;
- (2) Immediate corrective action is taken to eliminate, prevent, or control any food safety risk and imminent health hazard associated with the electrical or water service interruption; and
- (3) The Department is informed upon implementation of the written emergency operating plan.

8-404.12 Resumption of Operations.

(A) If operations are discontinued as specified under 8-404.11 or otherwise according to law, the permit holder shall obtain approval from the Department before resuming operation.

(B) Notwithstanding 8-904.20, a permit suspended for an imminent health hazard shall remain suspended until the imminent health hazard has been corrected.

8-405 Correction of Violations

8-405.11 Correction of Violations.

(A) The completed inspection report form shall specify a period of time for the correction of the violations found. Implementation of corrective action of all violations shall be within the following specified time periods:

- (1) All priority and priority foundation violations shall be corrected immediately. Considering the nature of the potential hazard involved and the complexity of the corrective action needed, the Department may schedule a follow-up inspection not to exceed ten (10) calendar days from the date of the inspection. **Pf**
- (2) All core violations that are operational shall be corrected as soon as possible. Verification of correction will be made at the time of the next routine inspection or earlier if deemed necessary by the Department.
- (3) Except as specified in (4) of this section, all consecutive core violations shall be corrected as soon as possible. A follow-up inspection shall be conducted to confirm correction within ten (10) calendar days from the date of the inspection.

(4) All core violations that are structural shall be corrected by the next routine inspection; however, additional time, not to exceed twelve (12) months, may be granted when such allowances present no public health hazard and the permit holder provides a written schedule for compliance.

(B) When a retail food establishment's routine inspection score is in the Grade C range or lower (less than 78 points), a subsequent routine inspection must be performed within sixty (60) calendar days of that C grade or lower inspection.

(C) Other than occurrences where a third consecutive inspection is rated below seventy (70) as described in 8-904.110 (C), when the rating score of the retail food establishment is less than seventy (70):

(1) The retail food establishment shall be downgraded to a grade C.

(2) Immediate corrective action on all identified priority, priority foundation, and core violations shall be initiated. **Pf**

(a) If priority and priority foundation violations cannot be corrected immediately the retail food establishment will be given the opportunity to cease all operations and close the facility voluntarily.

(b) If the retail food establishment refuses to cease operations voluntarily, the Department shall declare an imminent health hazard under 8-404.10.**P**

(3) Once a retail food establishment is closed, the retail food establishment will be allowed to reopen when all priority and priority foundation violations are corrected, as determined by the Department.

(4) A follow-up inspection shall be conducted within seventy-two (72) hours from the date of the inspection and as often as necessary to assure correction. If the retail food establishment fails to score seventy (70) or above on the follow-up inspection, action to suspend the permit shall be initiated.

8-5 PREVENTION OF FOODBORNE DISEASE TRANSMISSION BY EMPLOYEES

8-501 Investigation and Control

8-501.10 Obtaining Information: Personal History of Illness, Medical Examination, and Specimen Analysis.

The Department shall act when it has reasonable cause to believe that a food employee or conditional employee has possibly transmitted disease; may be infected with a disease in a communicable form that is transmissible through food; may be a carrier of infectious agents that cause a disease that is transmissible through food; or is affected with a boil, an infected wound, or acute respiratory infection, by:

(A) Securing a confidential medical history of the food employee or conditional employee suspected of transmitting disease or making other investigations as deemed appropriate; and/or

(B) Requiring appropriate medical examinations, including collection of specimens for laboratory analysis, of a suspected food employee or conditional employee.

8-501.20 Restriction or Exclusion of Food Employee or Summary Suspension of Permit.

Based on the findings of an investigation related to a food employee who is suspected of being infected or diseased, the Department may issue an order to the suspected food employee or permit holder instituting one or more of the following control measures:

(A) Restricting the food employee;

(B) Excluding the food employee; or

(C) Closing the retail food establishment by summarily suspending a permit to operate in accordance with law.

8-501.30 Restriction or Exclusion Order: Prior Warning or Hearing Not Required, Information Required in Order.

Based on the findings of the investigation as specified in 8-501.10 and to control disease transmission, the Department may issue an order of restriction or exclusion to a suspected food employee or the permit holder without prior warning, notice of a hearing, or a hearing if the order:

- (A) States the reasons for the restriction or exclusion that is ordered;
- (B) States the evidence that the food employee or permit holder shall provide in order to demonstrate that the reasons for the restriction or exclusion are eliminated; and
- (C) States that the suspected food employee or the permit holder may request a hearing as provided in law.

8-501.40 Removal of Exclusions and Restrictions.

A food employee, or conditional employee shall be released from restriction or exclusion when the employee or conditional employee no longer poses a threat to the public health.

8-6 CONSTITUTIONAL PROTECTION

8-602 Judicial Review

8-602.10 Rights of Recipients of Orders or Decisions.

A recipient of a Department decision or order may appeal the decision or order in accordance with applicable law.

8-7 AUTHORITY

8-701 Legal Authority

8-701.10 Adoption of Regulations and Enforcement.

(A) This regulation is issued under the authority of S.C. Code of Laws, Section 44-1-140, and shall be enforced by the Department.

(B) Should any chapter, paragraph, sentence, clause, or phrase of this regulation be declared unconstitutional or invalid for any reason, the remainder of this regulation shall not be affected thereby.

8-701.20 Enforcement.

Any facility found to be in violation of this regulation, in non-compliance with the requirements of this regulation, or in violation of an order issued by the Department shall be subject to civil penalties, permit suspension, and/or revocation pursuant to S.C. Code Ann. Section 44-1-150 and this regulation.

8-9 REMEDIES

8-903 Holding, Examination, and Destruction of Food

8-903.10 Hold Orders, Justifying Conditions, and Removal of Food.

(A) The Department may place a hold order on a food which is believed to be in violation of this regulation that:

- (1) Originated from an unapproved source;
- (2) May be unsafe, adulterated, or not honestly presented;
- (3) Is not labeled according to law, or, if raw molluscan shellfish, is not tagged or labeled according to law; or
- (4) Is otherwise not in compliance with this regulation.

(B) Should the hold order be violated, action may be initiated to suspend the permit.

(C) The Department may condemn, forbid the sale of, or cause to be removed or destroyed, any food, which is determined to be in violation of this regulation, unwholesome, contaminated, adulterated, or from an unapproved source.

8-903.20 Hold Order, Prior Warning, or Hearing Not Required.

The Department may issue a hold order to a permit holder or to a person who owns or controls the food, as specified in 8-903.10, without prior warning, notice of a hearing, or a hearing on the hold order.

8-903.30 Hold Order, Contents.

The hold order shall:

(A) State that food subject to the order may not be used, sold, moved from the retail food establishment, or destroyed without a written release from the Department;

(B) State the specific reasons for placing the food under the hold order with reference to the applicable provisions of this regulation and the hazard or adverse effect created by the observed condition;

(C) Completely identify the food subject to the hold order by the common name, the label information, a container description, the quantity, tag or identification information, and location;

(D) State that the permit holder has the right to a hearing and may request a hearing in accordance with applicable law; and

(E) State that the Department may order the destruction of the food if a timely request for a hearing is not received.

8-903.40 Hold Order, Official Tagging of Food.

(A) The Department shall securely place an official tag or label on the food or containers or otherwise conspicuously identify food subject to the hold order.

(B) The tag or other method used to identify a food that is the subject of a hold order shall be signed and dated by the Department.

8-903.51 Hold Order, Food May Not Be Used or Moved.

(A) Except as specified in (B) of this section, a food placed under a hold order may not be used, sold, served, or moved from the establishment by any person.

(B) The Department may allow the permit holder the opportunity to store the food in an area of the retail food establishment if the food is protected from subsequent deterioration and the storage does not restrict operations of the establishment.

8-903.70 Hold Order, Removing the Official Tag.

Only the Department may remove hold order tags, labels, or other identification from food subject to a hold order.

8-903.80 Destroying or Denaturing Food.

If a hold order is sustained upon appeal or if a timely request for a hearing is not filed, the Department may order the permit holder or other person who owns or has custody of the food to bring the food into compliance with this regulation or to destroy or denature the food under the Department's supervision.

8-903.90 Releasing Food from Hold Order.

The Department shall issue a notice of release from a hold order and shall remove hold tags, labels, or other identification from the food if the hold order is vacated.

8-904 Permit Suspension

8-904.10 Conditions Warranting Summary Suspension.

The Department may summarily suspend a permit to operate a retail food establishment if it determines through inspection, or examination of employees, food, records, or other means as specified in this regulation, that an imminent health hazard exists.

8-904.20 Summary Suspension, Warning, or Hearing Not Required.

The Department may summarily suspend a retail food establishment's permit by providing written notice of the summary suspension to the permit holder or person in charge, without prior warning, notice of a hearing, or a hearing.

8-904.30 Contents of the Summary Suspension Notice.

A summary suspension notice shall state:

(A) That the retail food establishment permit is immediately suspended and that all food operations shall immediately cease;

(B) The reasons for summary suspension with reference to the provisions of this regulation that are in violation;

(C) The name and address of the Department representative to whom a written request for re-inspection may be made and who may certify that reasons for the suspension are eliminated; and

(D) That the permit holder may request a hearing in accordance with applicable law.

8-904.40 Time Frame for Re-inspection.

After receiving a written request from the permit holder stating that the conditions cited in the summary suspension order no longer exist, the Department shall conduct a re-inspection of the retail food establishment for which the permit was summarily suspended within five (5) business days, which means five (5) days during which the Department's office is open to the public.

8-904.50 Term of Summary Suspension, Reinstatement of Permit.

(A) A summary suspension shall remain in effect until the conditions cited in the notice of suspension no longer exist and the Department, through re-inspection, has confirmed their elimination and other means as appropriate.

(B) The suspended permit shall be reinstated if the Department determines that the public health hazard or nuisance no longer exists. A notice of reinstatement shall be provided to the permit holder or person in charge.

8-904.110 Suspension of Permits.

(A) The Department may suspend permits for:

- (1) Consecutive priority and priority foundation violations;
- (2) Consecutive core violations;
- (3) Below seventy (70) inspection scores;
- (4) Failure to comply with the terms and conditions of the permit;
- (5) Failure to notify the Department of facility changes and to seek amendments to a permit as required by Section 8-304.11;
- (6) Failure to provide the Department access to the retail food establishment for the purpose of conducting an inspection or investigation;
- (7) Covering, obscuring, defacing, relocating, or removing the posted grade decal or permit;
- (8) Violation of a hold order;
- (9) Failure to pay applicable inspection renewal fee or failure to pay a civil penalty required pursuant to a Department order;
- (10) Failure to operate as a retail food establishment (serve or sell food) for at least fifteen (15) consecutive days annually or be in operation for at least one day every week for at least fifteen (15) weeks.
- (11) As otherwise determined by the Department pursuant to 8-102.10.

(B) The Department may revoke permits for:

- (1) Recurring failure to notify the Department of facility changes or to seek amendments to the permit;
- (2) Recurring failure to comply with the Terms and Conditions of the permit;
- (3) Recurring priority and priority foundation violations of the regulation;
- (4) Recurring failure to provide the Department access to the retail food establishment for the purpose of conducting an inspection or investigation;
- (5) Three (3) routine inspections in a two (2) year period that have a rating score of below seventy (70); or
- (6) Failure to operate as a retail food establishment (serve or sell food) for at least fifteen (15) consecutive days annually or be in operation for at least one day every week for at least fifteen (15) weeks.

(C) When a facility has a rating score of below seventy (70):

- (1) On the second routine inspection, Department staff shall be accompanied by an additional representative for verification of violations.
- (2) When the second routine inspection results in a score below seventy (70), the Department shall notify the permit holder, by letter, that if on the next routine inspection the score is less than seventy (70) action will be initiated to revoke the permit.

(3) On the third routine inspection, Department staff shall be accompanied by a standardization officer of the Department.

8-904.120 Notification of Permit Suspension and Permit Revocation.

Except as provided in 8-904.20, prior to permit suspension or permit revocation, the Department shall notify, in writing, the permit holder, person in charge, or an employee of the specific reasons for which the permit is to be suspended or revoked.

8-904.130 Term of Suspension, Reinstatement of Permit.

A permit suspension shall remain in effect until the conditions cited in the notice of permit suspension no longer exist and their elimination has been confirmed by the Department through re-inspection and other means as appropriate.

8-904.140 Interference with the Department.

Notwithstanding any other provisions of this regulation, the permit shall be revoked if a permit holder, person in charge, or employee engages in any of the following actions towards Department staff while performing, or as a result of performing, official duties and responsibilities:

- (A) Physical or verbal actions that constitute assault, battery, sexual or other harassment, or
- (B) Interference, intimidation, threat, or attempted bribery.

8-905 Appeals

8-905.10 Appeals.

A Department decision to deny an application for a permit, deny a request for a variance, impose a penalty, or suspend or revoke a permit may be appealed pursuant to applicable law.

8-905.40 Hearings and Appeals Procedures.

All appeals and hearings shall be conducted in accordance with applicable law.

8-913 Civil Penalties

8-913.10 Penalties.

Civil penalties for violations of this regulation or an order of the Department may be imposed pursuant to S.C. Code Ann. Section 44-1-150.

Chapter 9 Standards for Additional Retail Food Establishment Operations

9-1 MOBILE FOOD

This standard shall apply to the construction and operation of mobile food units as part of a retail food establishment.

(A) Definitions.

(1) A **mobile food establishment** consists of a commissary and mobile food unit(s) or mobile food pushcart(s). The food service portion of the operation is conducted from a movable driven or propelled vehicle, portable structure, or watercraft that can change location.

(2) A **commissary** is a permitted retail food establishment that is authorized by the Department to provide support of operations, storage, and servicing area for mobile food units or mobile food pushcarts, and is constructed and operated in compliance with the requirements of this regulation and standard. Retail food establishments that prepare and serve food to highly susceptible populations such as those operated by health care facilities that are regulated by the Department shall not be approved as a commissary.

(3) **Mobile food units** are fully enclosed mobile kitchens that may prepare, cook, or serve time/temperature control for safety foods as an extension of the commissary. A mobile food unit must be permitted by the Department in order to operate from a retail food establishment.

(4) **Mobile food pushcarts** are limited food service units that operate as an extension of a commissary. A mobile food pushcart must be permitted by the Department in order to operate from a commissary.

(B) General.

(1) A mobile food establishment shall comply with all applicable provisions of this regulation, except as outlined in this standard.

(2) The Department may prohibit the sale of certain time/temperature control for safety foods, and may modify specific requirements for physical facilities when, in the opinion of the Department, no health hazard will result.

(3) For servicing and storage:

(a) A full-service (self-contained) mobile food unit must return to the commissary at a frequency necessary to maintain sanitary conditions but in no case may operate for longer than seventy-two (72) hours of operation without returning to the commissary.

(b) Non-self-contained mobile food unit(s) and mobile pushcart(s) must return to the commissary within twenty-four (24) hours of operation.

(c) Mobile food unit(s) and mobile pushcart(s) that are not stored at the commissary must submit the proposed storage location for Department approval.

(C) Employees.

(1) Food employees shall not contact exposed, ready-to-eat-food with their bare hands and shall use suitable utensils such as deli tissue, spatulas, tongs, single-use gloves, or dispensing utensils.

(2) Personal clothing and belongings should be stored in a designated place away from food preparation, food service, dry storage areas, utensil and single-service article storage, and utensil washing areas.

(D) Food.

(1) General.

(a) A mobile food establishment shall prepare, hold, and serve food according to Chapter 3, *Food*.

(b) All food items shall be protected from contamination during transportation, storage, cooking, display, and service.

(c) Adequate refrigeration or coolers shall be provided. A temperature measuring device shall be provided for cold holding units.

(d) Packaged food may not be stored in direct contact with ice or water if the food is subject to the entry of water because of the nature of its packaging, wrapping, or container or it's positioning in the ice or water.

(e) Ice used as a coolant for foods shall not be used for edible ice.

(f) For the purpose of checking temperatures of food, a mobile food establishment shall have at least one temperature measuring device that meets the following requirements:

(i) Able to be calibrated and

(ii) Appropriate for the food density being checked.

(g) Hot held time/temperature control for safety foods on a mobile food unit or mobile pushcart shall be discarded at the end of the day at the commissary.

(h) Food(s) shall be stored, displayed, and served from the mobile food unit(s) and mobile food pushcart(s) only.

(2) Mobile Food Unit.

(a) Preparation of bulk food, including washing, slicing, peeling, and cutting, shall occur at the commissary.

(b) All food, single-service articles, and other items used for the operation of the mobile food unit shall be stored at the commissary or on the mobile food unit.

(c) Doors on mobile food units shall be kept closed at all times.

(3) Mobile Food Pushcart.

(a) All food, single-use articles, and other items used for the operation of the mobile food pushcart shall be stored at the commissary.

(b) Other than assembling food items for service, all food preparation, including washing, slicing, peeling, cutting, and cooking, shall occur at the commissary.

(c) Raw animal food shall not be cooked or prepared in any way on a mobile food pushcart.

(d) Door(s) on mobile food pushcarts shall be kept closed when not in use and during transportation.

(E) Service.

(1) During operations, food shall be stored, cooked, displayed, and served from the mobile food unit and mobile food pushcart only.

(2) Customer self-service of unpackaged time/temperature control for safety food is prohibited.

(3) Mobile food units and mobile food pushcarts shall provide only single-use articles for use by the consumer.

(4) Condiments shall be protected from contamination by being kept in dispensers that are designed to provide protection or offered in individual packages.

(5) Equipment and utensils shall be adequate in number and where appropriate shall be washed, rinsed, and sanitized as needed.

(6) In-use wiping cloths must be stored in a clean solution of an approved sanitizer.

(7) A test kit that accurately measures the parts per million concentration of an approved sanitizer shall be accessible and used.

(F) Construction.

(1) Mobile food units.

(a) Mobile food units shall have preparation and display areas completely enclosed with a solid material except as specified in (j) of this section.

(b) The serving window opening shall:

(i) Have an area of no more than five hundred seventy-six (576) square inches, and

(ii) Be covered with solid material or screen. Screening shall be at least sixteen (16) mesh per inch.

(iii) Be self-closing or free falling type, or covered by an approved air curtain when the serving window is open.

(c) Walls, floors, and ceilings must be smooth, cleanable, durable, and nonabsorbent.

(d) Light bulbs and fluorescent tubes shall be shielded, coated, or otherwise shatter-resistant and provide twenty (20) foot candles of illumination.

(e) Cooking and reheating equipment shall be installed on the unit, used in accordance with the manufacturer's instructions, and must meet the provisions of this regulation. Pull behind cookers or smokers are prohibited.

(f) All mobile food unit counters, shelves, and food contact surfaces shall be safe, corrosion resistant, nonabsorbent, smooth, easily cleanable, durable, and free of seams and difficult to clean areas.

(g) It is not the intent for mobile food units to wash, rinse, and sanitize utensils or equipment on the mobile food unit due to hot water demands. If mobile food units are designed to be self sufficient, a utensil washing sink shall:

(i) Have at least three (3) compartments large enough to accommodate two thirds of the largest utensil,

(ii) Have adequate space for air-drying,

(iii) Be supplied with hot and cold water under pressure, and

(iv) Be equipped with a mixing faucet that is capable of servicing all sink compartments per 4-301.12.

(h) Mechanical exhaust ventilation equipment shall be provided over all cooking equipment as required to effectively remove cooking odors, smoke, steam, grease, heat, and vapors.

(i) All mechanical exhaust ventilation equipment shall be installed and maintained in accordance to 4-301.14.

(j) Barbecue pit-cooking areas on mobile units must comply with 9-7, *Barbecue Pit And Pit-Cooking Room Construction*.

(2) Mobile food pushcarts.

(a) Mobile food pushcarts shall have preparation and display areas completely enclosed with a solid material.

(b) Food compartment(s) and food storage compartments must be adequately sized for the intended operation of the mobile food pushcart.

(c) Food compartments must be constructed from materials that are nontoxic, smooth, easily cleanable, durable, and constructed to facilitate the cleaning of the interior and exterior of the compartment.

(d) Food storage compartments shall not contain plumbing of any kind.

(e) All mobile food pushcart counters/shelves and food contact surfaces shall be safe, corrosion resistant, nonabsorbent, smooth, easily cleanable, durable, and free of seams and difficult to clean areas.

(G) Handwashing Sinks.

(1) All mobile food units and mobile food pushcarts shall have a separate handwashing sink.

(2) Soap and disposable paper towels shall be provided and adjacent to the handwashing sink.

(3) The handwashing sink shall be:

(a) Equipped with hot and cold water under pressure through a mixing valve or combination faucet. The hot water temperature shall be at least 100 degrees F (37 degrees C) as specified in 5-202.12; and

(b) Separated from food and food contact surfaces by either a splashguard or a distance of at least 12 inches; and

(c) Unobstructed and accessible to employees at all times.

(4) Gloves and/or hand sanitizers shall not be allowed as a substitute for handwashing facilities.

(H) Water System.

(1) All mobile food units and mobile food pushcarts shall have a drinking water system, under pressure, from an approved drinking water supply system.

(2) Mobile food units and mobile food pushcart water tanks shall comply with 5-3 of this regulation.

(3) Approved portable drinking water containers shall be stored and handled in a manner that protects the drinking water and equipment from contamination.

(4) The drinking water system tank shall be a minimum of five (5) gallons and of sufficient capacity to furnish hot and cold water for handwashing as specified in 5-202.12.

(5) If the mobile food unit is designed to be self sufficient, the hot water system shall be sufficient to meet hot water demands of at least 110 degrees F (43 degrees C) to the utensil washing sink and comply with all requirements pursuant to 5-103.11.

(6) A mobile food unit or mobile pushcart may temporarily use a direct connection to an approved drinking water source at the operating location when the following criteria are met:

(a) The mobile unit is connected to an approved public sewer or onsite wastewater system and

(b) Drinking water and sewage storage tanks remain on the unit at all times.

(I) Sewage Retention.

(1) Mobile food units and mobile food pushcart water tanks shall comply with 5-3 of this regulation.

(2) Sewage from a mobile pushcart may be stored in a removable retention tank that:

(a) Shall be fifteen (15) percent larger capacity than the drinking water supply tank;

(b) Cannot exceed ten (10) gallons (80 lbs) to be approved as portable;

(c) If sewage retention tanks are removable, they shall be permanently labeled 'sewage' to eliminate any confusion;

(d) Permanently installed sewage retention tanks on mobile pushcarts shall meet the same requirements as specified in (1) and (2) of this section.

(3) The mobile food unit and mobile pushcart sewage retention tank shall be thoroughly flushed and drained during the servicing operations at the commissary or approved sewage disposal site, and shall be discharged into a sanitary sewerage disposal system or onsite sewage system approved by the Department.

(4) Flushing and draining shall be done in a manner that does not contaminate floors or any other areas in the commissary or the servicing area.

(J) Servicing Area.

The surface of the servicing area shall be constructed of a smooth material, such as concrete or asphalt, and shall be maintained in good repair, kept clean, and be properly drained.

(K) Exemptions.

(1) A mobile food pushcart operated inside fully enclosed structures such as, but not limited to, malls or sports arenas may have the requirement for full enclosure waived if in the opinion of the Department, no risk of contamination to the food exists.

(2) Mobile food pushcarts that are used to serve commercially packaged, fully cooked boiled or steamed hot dogs with commercially packaged, fully cooked chili or ice cream may have the requirement for full enclosure waived if in the opinion of the Department, no risk of contamination to the food exists provided those are the only foods served from the unit.

(L) Compliance.

(1) No mobile food unit or a mobile food pushcart shall operate that does not have a permit issued by the Department.

(2) Only a mobile food establishment that complies with the requirements of this regulation and this standard shall be entitled to receive and retain a permit.

(3) The permit shall be kept in the mobile food unit or mobile food pushcart and shall be accessible at all times.

(4) No retail food establishment shall operate as a commissary that does not have an authorization issued by the Department.

(5) Only a retail food establishment that complies with the requirements of this regulation and this standard shall be entitled to, receive and retain such an authorization.

(6) The permit and authorization shall be kept in a location in the commissary and shall be accessible at all times as specified in 8-301.11.

(7) Any person that proposes to operate a mobile food unit or mobile food pushcart must apply to the Department for a permit through the application process.

(8) The following additional documentation shall be submitted as part of the application process:

(a) A proposed menu or list of foods that will be served from the mobile food unit or mobile food pushcart;

(b) A list of all equipment installed on the mobile food unit or mobile food pushcart;

(c) An operations plan that includes:

(i) Information about methods of cooking, if applicable,

(ii) Hot and cold holding of food,

(iii) The mobile food unit or mobile food pushcart operational locations and the hours of operation at those locations,

(iv) The location of the commissary, and the cleaning and servicing operations at the commissary,

(v) A supplemental application form completed by the permit holder for each mobile food unit or mobile food pushcart; and

(vi) Any other information requested by the Department.

(9) Once a mobile food unit or mobile food pushcart has been permitted, the Department shall be notified of any changes to the mobile food unit or mobile food pushcart, such as, but not limited to, operations, menu, or change in commissary in accordance with 8-304.11.

(10) The mobile food unit or mobile food pushcart shall be available for inspection at the commissary at any reasonable time when requested by the Department.

(11) If a mobile food unit or mobile food pushcart is not presented for inspection at the commissary at the appointed time, the commissary permit and mobile food unit or mobile food pushcart permit shall be suspended in accordance with 8-904.110.

(12) Each mobile food unit and mobile pushcart shall have its business name and address legibly printed in a contrasting color from the color of the mobile food unit or mobile food pushcart in a manner that is conspicuous to the consumer.

(13) Mobile food units or mobile food pushcarts currently permitted prior to the effective date of this regulation and in compliance with the previous regulation, but which do not fully comply with all the construction, equipment, and physical requirements of this regulation, shall be deemed acceptable provided the facilities and equipment:

- (a) Are capable of being maintained in a sanitary condition;
- (b) Are not a public health hazard or nuisance; and
- (c) Are replaced in the normal course of operation with equipment and facilities that meet the requirements of this standard and regulation.

9-2 MEAT/MEAT PRODUCT AND FISH/FISH PRODUCT SALES

This standard shall apply to meat/meat products and fish/fish products from source or preparation site to the point of sale.

(A) General.

(1) Meat/meat products and fish/fish products shall be protected from contamination by use of packaging or covered containers while being transported.

(2) Meat/meat products and fish/fish products being transported shall meet the requirements and sections of this regulation relating to approved source, food supplies, food protection, food storage, and sanitary control of liquid waste.

(3) Acceptable products for meat/meat products and fish/fish products sales under this standard are as follows:

- (a) Prepackaged frozen meat and fish/fish products which are processed and packaged in an approved food processing plant and are sold by the package or case,
- (b) Fresh unprocessed fish/fish products from an approved source which are whole, or
- (c) Fresh unprocessed shrimp with either the heads on or heads removed.

(B) Employees.

Meat/meat products and seafood and freshwater fish shall be delivered by persons with clean hands and wearing clean clothing.

(C) Food.

(1) All food/ice shall be obtained from sources approved by the Department.

(2) Meat/meat products and fish/fish products shall be protected from contamination when transported with other products.

(3) All food employees shall hold and display food according to all applicable sections of Chapter 3, *Food*.

(4) Packaged food may not be stored in direct contact with ice or water if the food is subject to the entry of water because of the nature of its packaging, wrapping, or container, or its positioning in the ice or water.

(5) Whole unpackaged fish/fish products may be stored in ice made from drinking water or obtained from an approved source.

(6) Ice used as a coolant for foods shall not be used for edible ice.

(7) During transport of meat/meat products and fish/fish products, there shall be at least one temperature measuring device for checking temperatures of food that meets the following requirements:

- (a) Able to be calibrated; and
- (b) Appropriate for the food density being checked.

(8) All fresh meat/meat products and fish/fish products shall be transported so as to maintain a temperature of 41 degrees F (5 degrees C) or below during the transportation period.

(D) Cleanliness/ Maintenance.

- (1) If meat/meat products and fish/fish products reach their destination at 41 degrees F (5 degrees C) or below, vehicles need not be refrigerated.
- (2) The storage portion of each vehicle shall be washed and cleaned.

9-3 OUTDOOR PET DINING

This standard shall apply to outdoor dining areas where table service of food is provided and shall not apply to customer pick up take out service with picnic type dining areas that may be provided by a retail food establishment

(A) Definition.

A **pet** is defined as domesticated cats, dogs, and ferrets.

(B) General.

(1) A retail food service establishment may allow customers to be accompanied by pets in an outdoor dining area provided the retail food service establishment complies with the requirements of this section and all other applicable sections of this regulation.

(2) Pets at retail food establishments shall also comply with the South Carolina Rabies Control Act Section 47-5-60.

(C) Employees.

Employees shall wash hands after any contact with pets, pet supplies, and pet waste.

(D) Service.

- (1) All tableware used for the pets shall be restricted to single-service or single-use articles.
- (2) Tables and chairs located in the outdoor pet dining area shall be easily cleanable.
- (3) Cleaning supplies and sanitizers shall be provided and stored in the outdoor pet dining area. These items shall be exclusively used for outdoor pet dining purposes only and stored outside.
- (4) Cleaning equipment necessary for the removal of pet waste shall be provided. These items shall be exclusively used for outdoor pet dining purposes only and stored outside.
- (5) Pet waste shall be removed immediately and the area shall be cleaned and sanitized.
- (6) A covered refuse container shall be located in the outdoor pet dining area and shall be used exclusively to store all pet waste generated by the outdoor pet dining area.

(E) Construction.

- (1) The retail food establishment shall post signs at the entrance of all dining areas stating the facility is pet dining friendly and has an outdoor pet dining area.
- (2) The retail food establishment shall post signs stating pets are only allowed in the outdoor pet dining area.
- (3) Outdoor pet dining areas shall have an outside entrance.
- (4) Pets shall be restricted to the outdoor pet dining area and shall not be allowed in the retail food establishment.
- (5) All pets shall be restrained and under control of the owners.
- (6) No pets are allowed on a table, countertop, or any other food contact surfaces within the outdoor pet dining area.

(F) Compliance.

(1) Retail food establishments that have pets on the premises and do not comply with this standard shall be cited for violations under Sections 2-403.11 and 6-501.115 as applicable.

(2) This standard shall not apply to service animals in outdoor or indoor dining areas.

9-4 WILD MUSHROOM FORAGING

Wild foraged mushrooms species must be individually inspected and found to be safe by an approved mushroom identification expert that:

(A) Has met the requirements of knowledge and passed an exam given by a 3rd party certifier that has been approved by the Department; and

(B) Will harvest only those mushrooms species listed below:

Pink Chanterelles (*Cantharellus cinnabarinus*)

Golden Chanterelles (*Cantharellus cibarius*, *C.lateritius*, *C. Appalachianensis*)

Yellow Morel (*Morchella esculenta*)

Tulip Morel (*Morchella deliciosa*)

Black morel (*Morchella elata*)

Black Trumpet (*Craterellus fallax*)

Lobster (*Hypomyces lactifluorum*)

Wood Ears (*Auricula auricularia*, *A. Fuscosuccinea*)

Chicken of the Woods (*Laetiporus sulphureus*, *L.cincinnatus*, *L.perscinus*)

Beefsteak (*Fistulina hepatica*)

Hedgehog (*Hydnum repandum*)

Lions Mane or Pom Pom (*Hericium erinaceus*, *H. ramosum*)

White Oyster Mushroom (*Pleurotus ostreatus*, *P. pulmonarius*, *P. populinus*, *P.floridanus*)

Cauliflower (*Sparassis crispa*, *S.herbstii*, *S.spathulata*)

Maitake (*Grifola frondosa*)

Blewits (*Clitocybe nuda*)

Honey (*Armillaria ostoyae*, *A.mellea*, *A.tabescens*)

Blue Milky (*Lactarius indigo*)

Golden Milkies (*Lactarius corrugis*, *L.volemus*)

Pecan Truffle (*Tuber lyonii*).

9-5 SHARED USE OPERATIONS

This standard shall apply to retail food establishments designed and operated for use by multiple permit holders.

(A) Definitions.

(1) **Shared use operation** means a facility designed for multiple and individually permitted retail food establishment(s) or other food processing plant(s) operating at different times using the same area and equipment for cooking, processing, or preparing food that is provided to the consumer. The purpose of a shared use operation is to provide farmers, caterers, gourmet food producers, and others interested in the production of food items, a facility to prepare food products. A shared use operation provides a licensed South Carolina Department of Agriculture or permitted retail food establishment the equipment and individual spaces necessary to prepare, package, store, and label their products. A shared use operation may also serve as a commissary for mobile food establishments provided it meets the requirements as per section 9-1, *Mobile Food*. Retail food establishments that prepare and serve food to highly susceptible populations such as those operated by health care facilities that are regulated by the Department shall not be approved as a shared use operation.

(2) **Facilitator** means the person responsible for all facility structural requirements, equipment, maintenance, and scheduling of a shared use operation.

(B) General.

(1) The facilitator shall obtain a retail food establishment permit and shall be responsible for the facility and equipment maintenance, utilities, refuse removal, and other common use services.

(2) A shared use operation and the associated retail food establishments shall comply with all applicable provisions of this regulation, except as outlined in this standard.

(3) The Department may prohibit the distribution of certain time/temperature control for safety food, and may modify specific requirements for physical facilities when, in the opinion of the Department, no health hazard will result.

(C) Compliance

(1) Facilitator.

(a) The facilitator shall provide to the Department the number of associated retail food establishments and/or licensed SCDA operators that the shared use kitchen can accommodate. The shared use operation shall not exceed this number of operators without first notifying the Department.

(b) The facilitator shall maintain a schedule of the associated retail food establishment(s) days and hours of operation. This information shall be provided to the Department weekly for purposes of inspections and foodborne outbreak or complaint investigations.

(c) Only those retail food establishment(s) that are scheduled to use the kitchen for a particular day and time will be allowed in the shared areas.

(d) The facilitator shall ensure that deliveries that are received are from approved sources and are placed into appropriate storage locations such that they are maintained at the required temperatures, protected from contamination, unadulterated and accurately presented.

(e) The facilitator shall provide notice to the Department prior to the addition or deletion of associated retail food establishments.

(2) Associated retail food establishments.

(a) Each proposed operator shall obtain a retail food establishment permit.

(b) Each associated retail food establishment shall be responsible for its own operation and shall be required to comply with all applicable sections of the regulation.

(c) Each associated retail food establishments shall have a secured dry storage area(s), and designated space in walk-in coolers and freezers for items exclusive to their operation.

(3) No person shall operate a shared use operation that does not have a permit issued by the Department pursuant to 8-301.11.

(4) Only a person who complies with the requirements of this regulation and standard shall be entitled to receive and retain such a permit.

(5) Any person who proposes to operate a shared use operation must apply to the Department for a permit on the application form provided by the Department pursuant to 8-302.

(6) The Department shall be notified of any changes to the shared use operation or associated retail food establishment, such as, but not limited to, operations, equipment, or menu, in accordance with 8-304.11.

9-6 IMMEDIATE OUTDOOR COOKING

This standard shall apply to retail food establishments that provide food by outdoor cooking, grilling, or roasting of the food on their premises.

(A) Definition.

Immediate outdoor cooking (IOC) is defined as the outdoor cooking, grilling, or roasting of food on the physical premises of a permitted retail food establishment. Immediate outdoor cooking activities shall not be associated with a mobile food unit, mobile food pushcart, farmer's market, or seasonal series.

(B) General.

(1) A retail food establishment that conducts IOC shall comply with all applicable provisions of this regulation, except as outlined in this standard.

(2) The Department may prohibit the distribution of certain time/temperature control for safety food, and may modify specific requirements for physical facilities when, in the opinion of the Department, no health hazard will result.

(3) The retail food establishment shall be in operation at all times during any IOC activities.

(4) The retail food establishment is solely responsible for all IOC provisions, including, but not limited to, employees, person in charge, food supplies, and preparations.

(5) The Department must approve the location that is to be considered the IOC area.

(6) The Department may have additional requirements due to environmental conditions that may pose a risk for contamination of food products. Under such conditions, the Department may limit or cease the use of the outdoor cooking and service areas.

(C) Employees.

Food employees shall not contact exposed, ready-to-eat-food with their bare hands and shall use suitable utensils such as deli tissue, spatulas, tongs, single-use gloves, or dispensing utensils.

(D) Food.

(1) All food preparation shall be completed inside the permitted retail food establishment.

(2) All food items shall be protected from contamination during transportation, storage, cooking, display, and service.

(3) All food employees shall prepare, hold, and serve food according to all applicable sections of Chapter 3, *Food*.

(4) IOC shall have at least one temperature measuring device for checking temperatures of food that meets the following requirements:

(a) Able to be calibrated; and

(b) Appropriate for the food density being checked.

(5) Leftover portions of food cooked during IOC shall be discarded immediately. No food shall be stored for future service.

(E) Service.

(1) Equipment used for IOC shall be limited to grills, steam pots and pizza ovens designed for outdoor use.

(2) The Department shall authorize IOC operations based on the following:

(a) The permitted retail food establishment must be of sufficient size and capability to support the same operations inside as well as IOC.

(b) The same or similar size or type of equipment used for cooking inside the permitted retail food establishment may be authorized for IOC.

(c) The same or similar type foods that are cooked inside the permitted retail food establishment may be authorized for IOC.

(3) Only the cooking and immediate service of food will be allowed during IOC operations, except that the serving of displayed food in the immediate cooking area must be completed within four (4) hours for any single function or activity.

(4) Food shall be kept covered, except during times of continuous serving or display.

(5) Covers or lids may be removed only for monitoring, stirring, or adding additional ingredients.

(6) Condiments must be dispensed in individual single-service type packets, pump dispensers, squeeze bottles, shakers, or similar dispensers which minimize contamination of food items by food employees, patrons, vermin, environmental conditions, or other sources.

(7) Equipment and utensils shall be adequate in number to conduct the IOC activities.

(8) In-use wiping cloths shall be stored in a clean solution of an approved sanitizer.

(9) The IOC area shall be effectively separated from the public.

(F) Construction.

(1) Floors shall be constructed of concrete, asphalt, tight wood, or other similarly cleanable material and shall be kept clean and in good repair.

(2) Light bulbs and fluorescent tubes shall be shielded, coated, or otherwise shatter-resistant and provide 20-foot candles of illumination.

(3) All IOC equipment, including tables, shall be safe, corrosion resistant, nonabsorbent, smooth, easily cleanable, durable, and free of seams and difficult to clean areas.

(4) Warewashing is not permitted outside. All utensils/equipment used in outdoor cooking/serving of food shall be returned to the permitted retail food establishment for proper cleaning; except that, in-place cleaning may be allowed for grills and similar equipment.

(G) Handwashing Sinks.

If IOC exceeds four (4) times per calendar year, the following handwashing sink requirement shall be met:

(1) A permanently installed exterior handwashing sink shall be provided pursuant to 5-202.12, 5-203.11 and 5-204.11.

(2) If using a portable handwashing sink, it shall have a minimum five (5) gallon potable water-dispensing tank and a minimum seven-point five (7.5) gallon waste water holding tank.

(3) The handwashing sink shall be provided with soap and disposable paper towels.

(4) When a permanently installed exterior handwashing sink is not required, a container of water with a spigot, soap, disposable towels and a catch bucket shall be provided.

(5) Gloves and/or hand sanitizers shall not be allowed as a substitute for handwashing facilities.

(H) Authorization.

(1) No retail food establishment shall conduct IOC operations that does not have an authorization issued by the Department.

(2) Any retail food establishment that operates or proposes to conduct IOC operations must apply to the Department for an authorization thru the application process.

(3) Only a retail food establishment who complies with the requirements of this regulation and this standard shall be entitled to, receive and retain such an authorization.

(4) Once IOC has been authorized, the retail food establishment shall notify the Department of any changes to the authorized IOC operation, such as, but not limited to, operations, procedures, menus, or changes in the retail food establishment in accordance with 8-304.11(B).

9-7 BARBECUE PIT AND PIT-COOKING ROOM CONSTRUCTION

This standard shall apply to the construction and operation of a barbeque pit or smokehouse room as part of a retail food establishment.

(A) Definition.

Barbecue is defined as a single process method of cooking by which meat, poultry, or fish (either whole or in pieces) is covered and slow cooked in a pit or on a spit using an indirect or direct heat source.

(B) General.

Barbecue pit rooms shall be located on the physical premises of the permitted retail food establishment.

(C) Employees.

(1) Food employees shall not contact exposed, ready-to-eat-food with their bare hands and shall use suitable utensils such as deli tissue, spatulas, tongs, single-use gloves, or dispensing utensils.

(2) Personal clothing and belongings shall be stored in a designated place away from food preparation, food service, dry storage areas, utensil and single-service article storage, and utensil washing areas.

(D) Food.

(1) All food items shall be protected from contamination during transportation, storage, cooking, display, and service.

(2) All food employees shall prepare, hold, and serve food according to all applicable sections of Chapter 3, *Food*.

(3) Pit rooms shall have at least one temperature measuring device for checking temperatures of food that meets the following requirements:

- (a) Able to be calibrated and
- (b) Appropriate for the food density being checked.

(4) Adequate refrigeration shall be provided to support the cooking activity conducted in the pit room at the permitted retail food establishment.

(E) Pit-Cooking Room Restrictions.

(1) Pit-cooking rooms built according to these minimum construction requirements shall be restricted to barbecue cooking equipment and the single process of cooking.

(2) No additional food preparation or processing activities shall be permitted in the pit room unless there is full compliance with all construction requirements pursuant to Chapter 6 of this regulation.

(F) Construction.

(1) All sides and the ceiling of the pit room shall be completely enclosed.

(2) Screening may be used above wainscot height, four (4) feet on walls, and must be at least sixteen (16) mesh per inch.

(3) All outside openings shall be protected against insects by tight-fitting, self-closing doors, closed windows, screening, approved fly fans, or other means.

(4) Canvas flaps or other effective devices may be required to protect against blowing contamination.

(5) A large tight-fitting garage door may be allowed without a self-closer but shall remain closed during cooking operations.

(6) Floors of pit-cooking rooms, excluding pit floors, shall be constructed of smooth, durable materials such as sealed concrete, quarry tile, vinyl floor covering, or other approved material.

(7) Floors shall be maintained in good repair.

(8) Floors approved for water flushing, such as quarry tile or sealed concrete, shall be graded to floor drains and shall have junctures between walls and floors sealed.

(9) Interior walls shall have smooth, easily cleanable, and washable surfaces to at least wainscot height (4 feet).

(10) If screening is used above wainscot, studs and other exposed bracing shall be sealed or painted.

(11) Concrete blocks or other masonry products used for wall construction shall be trowelled, skim-coated, or receive sufficient coats of full strength block filler to render a smooth surface prior to the application of a washable paint.

(12) Ceilings shall be finished to provide a smooth, nonabsorbent, and easily cleanable surface.

(13) Trusses and rafters shall not be exposed.

(14) Ceiling joists shall be properly sealed.

(15) Pit-cooking rooms shall be ventilated and kept reasonably free of excessive heat, vapors, smoke, and fumes by ventilating the pit itself or by ventilating the room. Pit ventilation can be achieved by a chimney or duct using dampers, pit doors, or other devices to control airflow. Pit-cooking rooms may be ventilated by a cathedral ceiling with screened roof-ridge vents, mechanical exhaust fans, or other effective methods approved by the Department when pits are not directly vented to the outside.

(16) At least twenty (20) foot-candles of light shall be provided at all working surfaces, including the handwashing sink.

(G) Cooking Pit and Cooker Construction.

(1) Cooking pit floors may consist of a solid base of compacted clay with a top layer of clean sand to absorb grease drippings. Sand shall be replaced as necessary to maintain a safe and sanitary condition.

(2) Pit floors may also be constructed of concrete, firebrick, or other material that can be cleaned and maintained.

(3) Cooking pit walls (exterior sides only) shall be smooth, easily cleanable, and washable.

(4) Concrete blocks or other masonry products used for pit construction shall be trowelled, skim coated, or receive sufficient coats of full strength block filler applied to the exterior wall prior to the application of a washable paint.

(5) Pit grills, grates, and other supports shall be constructed of smooth, easily cleanable, nonabsorbent, non-toxic material, and shall be in sections that are easily removable for cleaning.

(6) Hog wire, chicken wire, hardware cloth, and similar materials, that are not galvanized or have welded joints, are permitted for single-use only and shall be discarded after each cooking period. Expanded metal and cast iron grating are recommended materials that can be cleaned and maintained.

(7) Pit covers shall be single-use or shall be constructed of a smooth, easily cleanable, nonabsorbent, and non-toxic material.

(8) The use of cookers and mobile cookers in lieu of a barbeque pit shall require the prior approval of the Department. These units shall be located in the pit room.

(H) Handwashing Sinks.

(1) Handwashing sinks shall be provided pursuant to 5-202.12, 5-203.11, and 5-204.11.

(2) The handwashing sink shall be provided with soap and disposable paper towels.

(3) Gloves and/or hand sanitizers shall not be allowed as a substitute for handwashing facilities.

(I) Authorization.

(1) No retail food establishment shall operate a barbecue pit that does not have an authorization issued by the Department.

(2) Any retail food establishment that operates or proposes to operate a barbecue pit must apply to the Department for an authorization through the application process.

(3) The following additional documentation shall be submitted as part of the application process:

(a) Information about food prepared in the barbecue pit room and

(b) Any other information requested by the Department.

(4) Only a retail food establishment that complies with the requirements of this regulation and standard shall be entitled to receive and retain such an authorization.

(5) Once a barbecue pit has been authorized, the Department shall be notified of any changes to the barbecue pit, such as, but not limited to, operational changes, menu changes, or changes in the barbecue pit in accordance with 8-304.11(B).

9-8 TEMPORARY FOOD SERVICE ESTABLISHMENTS

This standard shall apply to the construction and operation of a temporary food establishment.

(A) Definitions.

A **temporary food service establishment** is defined as an establishment that may be authorized by the Department to operate at a fixed location for a period of time not to exceed fourteen (14) consecutive days in connection with a fair, carnival, circus, trade show, movie or filming location, golf or other national sporting events, and other transitory gatherings organized by the community. This standard also applies to retail food service establishments that operate in an area affected by a natural or man-made disaster and where a state of emergency or a public health emergency has been declared.

(B) General.

(1) Temporary food service establishments shall comply with all applicable sections of this regulation except as outlined in this standard.

(2) The Department may prohibit the distribution of certain time/temperature control for safety food, and may modify specific requirements for physical facilities when, in the opinion of the Department, no health hazard will result.

(C) Employees.

(1) Food vendors and/or employees shall not contact exposed, ready-to-eat-food with their bare hands and shall use suitable utensils such as deli tissue, spatulas, tongs, single-use gloves, or dispensing utensils.

(2) Personal clothing and belongings shall be stored in a designated place away from food preparation, food service, dry storage areas, utensil and single-use article storage, and utensil washing areas.

(D) Food.

(1) All food/ice shall be obtained from sources approved by the Department.

(2) All food items shall be protected from contamination during transportation, storage, cooking, display, and service.

(3) All food vendors shall prepare, hold, and serve food according to all applicable sections of Chapter 3, *Food*.

(4) All time/temperature for safety food cooked offsite shall be provided by a retail food establishment or mobile food establishment permitted under this regulation.

(5) Time/temperature for safety foods that have been cooked or are in hot holding at any point during the daily operating hours shall be discarded at the end of the day.

(6) Condiments shall be protected from contamination by being kept in dispensers that are designed to provide protection or offered in individual packages.

(7) Cakes, breads, and cookies that are not made at a permitted retail food establishment may be offered for sale only if they are not a time/temperature for safety food.

(8) Ice shall be obtained in closed single-service bags or approved covered containers and shall be protected from contamination. Ice used as a coolant for foods shall not be used for edible ice.

(9) Each temporary food service establishment shall have at least one temperature measuring device for checking temperatures of food that meets the following requirements:

- (a) Able to be calibrated; and
- (b) Appropriate for the food density being checked.

(E) Service.

(1) During operations, food shall be stored, cooked, displayed, and served from the temporary food service establishment only.

(2) Customer self-service of unpackaged time/temperature control for safety foods is prohibited.

(3) Temporary food service establishments shall provide only single-service articles for use by the consumer.

(4) Condiments shall be protected from contamination by being kept in dispensers that are designed to provide protection or offered in individual packages.

(5) In use wiping cloths must be stored in clean solution of an approved sanitizer.

(6) A test kit that accurately measures the parts per million concentration of an approved sanitizer shall be accessible and used.

(7) Food shall be kept covered except during times of continuous serving or display.

(8) Covers or lids may be removed only for monitoring, stirring, or adding additional ingredients.

(F) Construction.

(1) Floors shall be constructed of concrete, asphalt, tight wood, or other similar cleanable material.

(2) Floors shall be kept clean and in good repair.

(3) Walls shall be constructed of a solid, easily cleanable material.

(4) Screening may be used above wainscot height, four (4) feet, on walls and must be at least sixteen (16) mesh per inch.

(5) Studs and joists may be exposed, provided they are sealed.

(6) Ceilings shall be constructed of a solid, easily cleanable material.

(7) Exposed ceiling joists and rafters may be allowed, provided they are sealed.

(8) Light bulbs and fluorescent tubes shall be shielded, coated, or otherwise shatter-resistant and provide at least twenty (20) foot candles of illumination.

(9) All outside openings shall be protected against insects by tight-fitting, self-closing doors, closed windows, screening, approved air curtains, or other means.

(10) Canvas flaps or other effective devices may be required to protect against blowing contamination where screening is used.

(11) Counterservice openings shall be equipped with approved air curtains, self-closing windows, or free-falling windows or screens that must be at least sixteen (16) mesh per inch. Where air curtains are used, the size of the openings shall be limited so that the fans effectively prevent the entrance of flying insects.

(12) A temporary food establishment shall be equipped with a warewashing sink with at least three (3) compartments large enough to accommodate two thirds of the largest utensil. This requirement shall not apply to temporary food establishments engaged only in the dispensing of prepackaged food.

(13) The warewashing sink shall be supplied with hot and cold water under pressure, equipped with a mixing faucet that is capable of servicing all sink compartments.

(14) Adequate refrigeration shall be provided.

(15) A temperature measuring device shall be provided for each refrigeration unit.

(16) Equipment shall be installed in a manner that allows it to be maintained in a sanitary condition.

(17) Ice and beverages may be dispensed in the serving area if protected from contamination. This area must be sheltered but is not required to be screened or enclosed.

(G) Handwashing Sinks.

(1) All temporary food service establishments shall have a separate handwashing sink, equipped with hot and cold water under pressure through a mixing valve or combination faucet.

(2) The handwashing sink shall be separated from food and food contact surfaces by either a splashguard or a distance of at least twelve (12) inches.

(3) Soap and disposable paper towels must be provided and be adjacent to the handwashing sink.

(4) Gloves and/or hand sanitizers shall not be allowed as a substitute for handwashing facilities.

(H) Water system.

(1) Drinking water hoses shall be made from food grade materials and shall be a different color from hoses used for sewage.

(2) Drinking water hoses shall be capped or covered when not in use and shall be stored separately from sewage hoses.

(3) When attached to a drinking water system, the temporary food service establishment shall be equipped with an approved backflow prevention device.

(4) Connections to the drinking water and sewage tanks shall be different types or sizes to eliminate contamination of the drinking water supply.

(5) Sewage and drinking water hose connections shall not be interchangeable.

(6) Water heaters with sufficient capacity shall be provided in facilities that prepare and serve time/temperature for safety food.

(I) Sewage Retention.

(1) Sewage that is not directly discharged into an approved sewage system shall be kept in closed containers adequate in number and capacity to prevent spillage and must be discharged into an approved sewage disposal system as often as needed.

(2) All sewage lines shall be connected to sewage tanks with watertight seals.

(3) Used cooking oil shall be disposed of in an approved manner.

(4) Adequate and approved toilet facilities shall be provided.

(5) Adequate trash cans and other sanitary facilities, as deemed necessary by the Department, shall be provided to support the temporary food service establishments operating at the event.

(J) Specific Exemptions.

(1) Temporary food service establishments are exempt from the requirements for training certification in 2-102.12(B).

(2) Temporary food service establishments that provide foods pursuant to 8-301.12(A)(11),(12),(19) and (20) of this regulation are exempt from the requirements of this standard.

(K) Authorization.

(1) No person, retail food establishment, or mobile food unit may serve time/temperature for safety food at a temporary food service establishment unless the sponsoring entity obtains authorization from the Department.

(2) The sponsoring entity of an event where temporary food service establishments will operate shall appoint an Event Coordinator as a point of contact.

(3) Any sponsoring entity that operates or proposes to operate an event where temporary food service establishments will operate shall apply for authorization on the form provided by the Department prior to commencement of the event. The following information shall be submitted with the application:

(a) Event Coordinator name and contact information;

(b) The dates of the fourteen (14) consecutive days of operation;

(c) A list of temporary food service establishments, with contact information, that will operate at the event; and

(d) The time that all temporary food service establishments are required to be ready for operation.

(4) Each temporary food service establishment shall be authorized by the Department prior to serving food to the public at the event.

(5) The Department may require a sponsoring entity or a temporary food service establishment to submit information sufficient to determine if the definition and requirements of this standard or regulation are met. This information may include, but is not limited to, information defining the fair, carnival, circus, or organized event, event schedule(s), hours of food vendor operations, vendor list and foods specific to those vendors, and vendor contact information.

(6) All food vendors shall meet the requirements for temporary food service establishment.

(7) Food vendors shall not be allowed to operate under the requirements of Sections 9-9, *Community Festivals*, 9-10, *Special Promotions*, or 9-11, *Retail Food Establishment - South Carolina Farmers Markets, Seasonal Series, and Remote Service*, of this regulation.

(8) When the Department determines that a sponsoring entity or a temporary food service establishment has violated applicable provisions of this standard or regulation, the Department may issue a written notice directing any or all temporary food service establishments to cease operations until the violations are corrected as determined by the Department.

(9) Any temporary food service establishment that proposes to operate at one event and location for more than fourteen (14) days, either by remaining in operation for additional consecutive days, or by reopening after a short period of closure, shall comply with the requirements for, and be permitted as, a retail food establishment or a mobile food establishment.

(10) If a retail food service establishment is operating as a temporary food service establishment in an area affected by a natural or man-made disaster after a state of emergency or a public health emergency has been declared, it may be allowed to exceed fourteen (14) consecutive days of operation if approved by the Department.

9-9 COMMUNITY FESTIVALS

This standard shall apply to the service of food and the requirements of food vendors at community festivals.

(A) Definitions.

Community festivals are defined as events sponsored by a community group, city/county/state organization, as a community celebration, that are generally theme related, and have multiple food vendors recruited to provide food to the public for a time period not to exceed three (3) consecutive days or no more than seventy-two (72) continuous hours. Each community festival is unique and will not be held more frequently than annually, although a sponsoring organization or group might have multiple but differently themed community festivals in a year.

(B) General.

(1) Community festival food vendors shall comply with all applicable sections of this regulation except as outlined in this standard.

(2) The Department may prohibit the distribution of certain time/temperature control for safety food and may modify specific requirements for physical facilities when, in the opinion of the Department, no health hazard will result.

(C) Employees.

(1) Food vendor employees shall not contact exposed, ready-to-eat-food with their bare hands and shall use suitable utensils such as deli tissue, spatulas, tongs, single-use gloves, or dispensing utensils.

(2) Personal clothing and belongings shall be stored in a designated place away from food preparation, food service, dry storage areas, utensils, single-use article storage, and utensil washing areas.

(D) Food.

(1) All food/ice shall be obtained from sources approved by the Department.

(2) All food items must be protected from contamination during transportation, storage, cooking, display, and service.

(3) All food vendors shall prepare, hold, and serve food according to all applicable sections of Chapter 3, *Food*.

(4) Time/temperature for safety foods, such as raw meat products, shall be ready to be cooked.

(5) All time/temperature for safety food fully prepared or cooked offsite shall be provided by a retail food establishment or mobile food establishment permitted under the regulation.

(6) Only quantities of meat, such as barbecue, may be pulled, chopped, or cut for same day service in the food vendor's preparation area.

(7) No mechanical chopping equipment will be allowed in unenclosed preparation areas.

(8) Time/temperature for safety foods that have been cooked or in hot holding at any point during the daily operating hours shall be discarded at the end of the day.

(9) Condiments shall be protected from contamination by being kept in dispensers that are designed to provide protection or offered in individual packages.

(10) Cakes, breads, and cookies that are not made at a permitted retail food establishment may be offered for sale only if they are not a time/temperature for safety food.

(11) Ice shall be obtained in closed single-service bags or approved covered containers and shall be protected from contamination. Ice used as a coolant for foods shall not be used for edible ice.

(12) Each community festival food vendor shall have at least one temperature measuring device for checking temperatures of food that meets the following requirements:

(a) Able to be calibrated; and

(b) Appropriate for the food density being checked.

(13) Food shall be kept covered except during times of continuous serving or display.

(14) Covers or lids may be removed only for monitoring, stirring, or adding additional ingredients.

(E) Construction.

(1) Food preparation areas shall have overhead protection and adequate barriers (e.g., tables or equipment) to prevent the access to the area by the public.

(2) Equipment shall arrive clean and ready to use.

(3) Utensils and single use articles shall be clean, protected during storage, and in sufficient quantities to conduct the activity.

(F) Handwashing Sinks.

(1) When a handwashing sink is not available, a container of water with a spigot, soap, disposable towels, and a catch bucket shall be provided.

(2) Gloves and/or hand sanitizers shall not be allowed as a substitute for handwashing facilities.

(G) Water system.

(1) Drinking water hoses shall be made from food grade materials and shall be a different color from hoses used for sewage.

(2) Drinking water hoses shall be capped or covered when not in use and shall be stored separately from sewage hoses.

(3) When attached to a drinking water system, the hose shall be equipped with an approved backflow prevention device.

(H) Sewage Retention.

(1) Sewage that is not directly discharged into an approved sewage system shall be kept in closed containers with adequate capacity or adequate in number to prevent spillage and must be discharged into an approved sewage disposal system as often as needed.

(2) All sewage lines shall be connected to sewage tanks with watertight seals.

(3) Used cooking oil shall be disposed of in an approved manner.

(4) Adequate toilet facilities shall be provided.

(5) Adequate trash cans and other sanitary facilities, as deemed necessary by the Department, shall be provided to support the community festival food vendors.

(I) Specific Exemptions.

(1) Community festival food vendors are exempt from the requirements for training certification in 2-102.20.

(2) Community festival food vendors that provide food pursuant to 8-301.12(A)(11),(12),(19) and (20) are exempt from the requirements of this standard.

(3) Hot water requirements are waived for food vendors at community festivals.

(J) Authorization.

(1) No person, retail food establishment, or mobile food unit may serve time/temperature control for safety food at a community festival unless the sponsoring entity obtains authorization from the Department.

(2) The sponsoring entity of a community festivals shall appoint an Event Coordinator as a point of contact.

(3) Any sponsoring entity that operates or proposes to operate a community festival where time/temperature for safety food will be served shall apply for authorization on the form provided by the Department prior to commencement of the festival. The following information must be submitted with the application:

(a) The Event Coordinator's name and contact information;

(b) The dates of the seventy-two (72) continuous hour period in which all food vendors will be in operation;

(c) A list of food vendors, with contact information, that will operate at the event; and

(d) The time that all food vendors are required to be ready for operation.

(4) Each community festival food vendor shall be authorized by the Department prior to serving food to the public at the festival.

(5) The Department may require a sponsoring entity or a food vendor to submit information sufficient to determine if the definition and requirements of this standard or regulation are met. This information may include, but is not limited to, information defining the community group, city/county/state organization, event schedule(s), hours of food vendor operations, vendor list and foods specific to those vendors, and vendor contact information.

(6) When the Department determines that a sponsoring entity or a food vendor has violated applicable provisions of this standard or regulation, the Department may issue a written notice directing any or all food vendors to cease operations until the violations are corrected as determined by the Department.

9-10 SPECIAL PROMOTIONS

This standard shall apply to the service of food and the requirements of food vendors at special promotions.

(A) Special promotions are defined as events sponsored by businesses or city/county organizations that may be authorized by the Department to prepare and dispense food for the purpose of promoting a product or service. Preparation and dispensing food at special promotions are limited to one (1) day in duration at four (4) separate times per year. Special promotions do not include regularly occurring sporting events, such as, but not limited to, school ballgames.

(B) General.

(1) Food preparation and service areas shall comply with all applicable sections of this regulation except as outlined in this standard.

(2) The Department may prohibit the distribution of certain time/temperature control for safety foods, and may modify specific requirements for physical facilities when, in the opinion of the Department, no health hazard will result.

(C) Employees.

(1) Food vendor employees shall not contact exposed, ready-to-eat-food with their bare hands and shall use suitable utensils such as deli tissue, spatulas, tongs, single-use gloves, or dispensing utensils.

(2) Personal clothing and belongings shall be stored in a designated place away from food preparation, food service, dry storage areas, utensil and single-use article storage, and utensil washing areas.

(D) Food.

(1) All food/ice shall be obtained from sources approved by the Department.

(2) All food items must be protected from contamination during transportation, storage, cooking, display, and service.

(3) All food vendors shall prepare, hold, and serve food according to all applicable sections of Chapter 3, *Food*.

(4) Time/temperature for safety foods, such as raw meat products, shall be ready to be cooked.

(5) All time/temperature for safety food cooked offsite shall be provided by a retail food establishment or mobile food establishment permitted under this regulation.

(6) Condiments shall be protected from contamination by being kept in dispensers that are designed to provide protection or offered in individual packages.

(7) Cakes, breads, and cookies that are not made at a permitted retail food establishment may be offered for sale only if they are not a time/temperature for safety food.

(8) Ice shall be obtained in closed single-service bags or approved covered containers and shall be protected from contamination.

(9) Ice used as a coolant for foods shall not be used for edible ice.

(10) Each food vendor shall have at least one temperature measuring device for checking temperatures of food that meets the following requirements:

- (a) Able to be calibrated; and
- (b) Appropriate for the food density being checked.

(E) Construction.

(1) Food preparation areas shall have overhead protection and adequate barriers (e.g., tables or equipment) to prevent the access to the area by the public.

(2) Equipment shall arrive clean and ready to use.

(3) Utensils and single-service articles shall be clean, protected during storage, and in sufficient quantities to conduct the activity.

(F) Handwashing Sinks.

(1) When a handwashing sink is not available, a container of water with a spigot, soap, disposable towels, and a catch bucket shall be provided.

(2) Gloves and/or hand sanitizers shall not be allowed as a substitute for handwashing facilities.

(G) Water system.

(1) Drinking water hoses shall be made from food grade materials and shall be a different color from hoses used for sewage.

(2) Drinking water hoses shall be capped or covered when not in use and shall be stored separately from sewage hoses.

(3) When attached to a drinking water system, the hose shall be equipped with an approved backflow prevention device.

(H) Sewage Retention.

(1) Sewage that is not directly discharged into an approved sewage system shall be kept in closed containers with adequate capacity to prevent spillage and must be discharged into an approved sewage disposal system as often as needed.

(2) All sewage lines shall be connected to sewage tanks with watertight seals.

(3) Used cooking oil shall be disposed of in an approved manner.

(I) Specific Exemptions.

(1) Special promotions are exempt from the requirements for training certification in 2-102.20.

(2) Special promotions that provide food pursuant to 8-301.12(A)(11),(12),(19) and (20) are exempt from the requirements of this standard.

(3) Hot water requirements are waived for special promotions.

(4) Toilet and service sink facilities are not required for special promotions.

(J) Authorization.

(1) The Department may require a sponsoring entity to submit information sufficient to determine if a special promotion complies with this standard and regulation. This information may include, but is not limited to, information defining the businesses, or city/county organizations, event schedule(s), hours of food vendor operations, vendor list and foods specific to those vendors, and vendor contact information.

(2) When the Department determines that a sponsoring entity has violated applicable provisions of this standard or regulation, the Department may issue a written order directing the special promotion to cease operations.

This standard shall apply to the service of food and the requirements of food vendors participating in SC Farmers Markets, Seasonal Series, Remote Service Operations, or other events as approved by the Department.

(A) Definitions.

(1) **Community-based farmers market** means a market sponsored by a community or governmental organization either having been Certified by the South Carolina Department of Agriculture as a SC Certified Farmer's Market or a farmers market that meets the definition of the Farmers Market Coalition which states, "A farmers market operates multiple times per year and is organized for the purpose of facilitating personal connections that create mutual benefits for local farmers, shoppers, and communities and implements rule or guidelines of operation that ensure that the farmers market consists principally of farms selling directly to the public products that the farms have produced."

(2) **Seasonal series** means a regularly occurring event sponsored by a community or governmental organization for promoting local business, culture, or other local specialties.

(3) **Remote service operation** means a permitted retail food establishment providing food to individual consumers at an indoor location by food employees of the retail establishment who maintain control of the food service.

(B) General.

(1) Retail food establishments at a seasonal series or community-based farmers market or remote service site shall comply with all applicable sections of this regulation except as outlined in this standard.

(2) The Department may prohibit the distribution of certain time/temperature control for safety foods and may modify specific requirements for physical facilities when, in the opinion of the Department, no health hazard will result.

(3) Permitted retail food establishments may be authorized by the Department to cook and serve food to the public at community farmers markets and/or seasonal series only two (2) days per week during one continuous period of time not to exceed six (6) hours.

(4) Community-based farmers market and seasonal series shall designate the days of the week food vendors are allowed to operate.

(5) Roadside produce stands and flea markets are not defined as community-based farmers markets or seasonal series, and this standard shall not apply to those locations.

(C) Employees.

(1) Retail food establishment employees shall not contact exposed, ready-to-eat-food with their bare hands and shall use suitable utensils such as deli tissue, spatulas, tongs, single-use gloves, or dispensing utensils.

(2) Personal clothing and belongings shall be stored in a designated place away from food preparation, food service, dry storage areas, utensils and single-use article storage, and utensil washing areas.

(D) Food.

(1) Preparation of bulk food, including washing, slicing, peeling, and cutting, shall occur at the permitted retail food establishment.

(2) All food items shall be protected from contamination during transportation, storage, cooking, display, and service.

(3) All food vendors shall prepare, hold, and serve food according to all applicable sections of Chapter 3, *Food*.

(4) Time/temperature for safety foods that have been cooked or are in hot holding at any point during the daily operating hours shall be discarded at the end of the day.

(5) Condiments shall be protected from contamination by being kept in dispensers that are designed to provide protection or offered in individual packages.

(6) Ice shall be obtained from an approved source, in closed single-service bags or approved covered containers and shall be protected from contamination.

- (7) Ice used as a coolant for foods shall not be used for edible ice.
- (8) Each retail food establishment shall have at least one temperature measuring device for checking temperatures of food that meets the following requirements:
 - (a) Able to be calibrated; and
 - (b) Appropriate for the food density being checked.
- (9) Food shall be kept covered except during times of continuous serving or display.
- (10) Covers or lids shall not be removed other than for monitoring, stirring, or adding additional ingredients.

(E) Construction.

- (1) Food preparation areas shall be provided with overhead protection and have adequate barriers (e.g., tables or equipment) to prevent the access to the area by the public.
- (2) Equipment and utensils shall arrive clean, ready to use, and in sufficient quantities to conduct the activity.
- (3) Equipment and utensils shall only be cleaned at the permitted retail food establishment.
- (4) Only single-service articles shall be provided for use by the consumer.

(F) Handwashing Sinks.

- (1) Each food vendor shall have at least one (1) handwashing facility located at the individual vendor location that may be either:
 - (a) A portable handsink that provides water under pressure or
 - (b) A container of water with a spigot and catch bucket.
- (2) All handwashing facilities must have adequate water dispensing storage capacity to meet the demand for handwashing. The wastewater storage capacity must be larger than the water storage container.
- (3) Handwashing facilities must include soap and disposable towels.
- (4) Gloves and/or hand sanitizers shall not be allowed as a substitute for handwashing facilities.

(G) Water System.

- (1) Drinking water hoses shall be made from food grade materials and shall be a different color from hoses used for sewage.
- (2) Drinking water hoses shall be capped or covered when not in use and shall be stored separately from sewage hoses.
- (3) When attached to a drinking water system, the hose shall be equipped with an approved backflow prevention device.

(H) Sewage Retention and Refuse Removal.

- (1) Sewage that is not directly discharged into an approved sewage system shall be kept in closed containers adequate in number and capacity to prevent spillage and must be discharged into an approved sewage disposal system as often as needed.
- (2) All sewage lines shall be connected to sewage tanks with watertight seals.
- (3) Used cooking oil shall be disposed of in an approved manner.
- (4) Adequate toilet facilities shall be provided.
- (5) Adequate trash cans, as deemed necessary by the Department, shall be provided to support the retail food establishment.

(I) Specific Exemptions.

Seasonal series or community-based farmers markets that provide foods pursuant to 8-301.12(A)(11),(12),(19) and (20) are exempt from authorization based on the requirements of this standard.

(J) Authorization.

- (1) No retail food establishment, or mobile food unit may serve time/temperature control for safety foods at a seasonal series or community-based farmers market unless the sponsoring entity

obtains authorization from the Department. Pre-approval is not required for remote service operations.

(2) The sponsoring entity of a seasonal series or community-based farmers market shall appoint an Event Coordinator as a point of contact.

(3) Any sponsoring entity that operates or proposes to operate a seasonal series or community-based farmers market where time/temperature control for safety foods will be served by retail food establishments shall apply for authorization from the Department. The following information shall be submitted:

- (a) The Event Coordinator name and contact information;
- (b) The one day of the week and hours of operation for food service; and
- (c) A list of retail food establishments, with contact information, that will operate at the event.

(4) Each retail food establishment at a seasonal series or community-based farmers market shall be authorized by the Department prior to serving food to the public at the event.

(5) The Department may require a sponsoring entity or a retail food establishment to submit information sufficient to determine if the definition and requirements of this standard or regulation are met. This information may include, but is not limited to, information defining the community group, governmental organization, SC Certified Farmer's Market certification, association to Farmers Market Coalition, event schedule(s), hours of food vendor operations, vendor list and foods specific to those vendors, and vendor contact information.

(6) When the Department determines that a sponsoring entity or a retail food establishment has violated applicable provisions of this standard or regulation, the Department may issue a written notice directing any or all retail food establishment vendors to cease operations until the violations are corrected as determined by the Department.

HISTORY: Amended by State Register Volume 19, Issue No. 6, eff June 23, 1995; State Register Volume 38, Issue No. 6, Doc. No. 4424, eff June 27, 2014; State Register Volume 39, Issue No. 4, Doc. No. 4424, eff April 24, 2015 (errata); SCSR 43-5 Doc. No. 4842, eff May 24, 2019; SCSR 43-9 Doc. No. 4842, eff September 27, 2019 (errata).

61-28. Repealed.

HISTORY: Former Regulation, titled Horse Meat and Kangaroo Meat, repealed by State Register Volume 40, Issue No. 4, Doc. No. 4552, eff April 22, 2016.

61-29. Environmental Health Inspections and Fees.

A. Purpose. The Department of Health and Environmental Control (Department), to prevent disease and protect the environment, is required by various state laws and regulations to conduct environmental health inspections at facilities licensed, regulated, or registered by other state agencies. The Department also is requested by various state and federal agencies by policy or program guidelines to provide general environmental health inspections of specified facilities. These inspections cannot be provided unless funds to defray the cost of conducting the inspections and administering and operating the program are made available.

B. Inspections. The Department may conduct environmental health inspections for agencies which have developed inspection standards. These inspection standards shall be approved by the Department prior to performance of environmental health inspections. Requests for inspection shall be made by the agency on forms prescribed by the Department and shall contain all information requested on the form. The Department shall report the results of the inspection to the facility and to the requesting agency.

C. Facilities. Facilities subject to these inspections include, but are not limited to: Private and Public Child Day Care Centers, Child Day Care Centers Operated by Religious Bodies or Groups, Private and Public Group Day Care Centers, Family Day Care Homes, Residential Child Caring Institutions, Residential Group Caring Facilities for Children, and Spouse Abuse Shelters under the jurisdiction of the Department of Social Services (DSS), and Child Development Centers under the jurisdiction of the Department of Mental Retardation (DMR).

D. Fees. The fee for conducting environmental health inspections is sixty dollars (\$60.00) per facility, and shall be remitted to the Department by the agency requesting the inspection, or in such other manner as approved by the Department, prior to the inspection.

E. Enforcement Provisions. The Department shall conduct follow-up inspections and provide consultation and assistance to owners/operators of facilities with violations of statutes and regulations enforced by the Department (e.g., water, sewage, swimming pools, and lead). Follow-up inspections to ascertain compliance with other inspection standards noted by the Department are the responsibility of the requesting agency. The Department shall cooperate with the requesting agency in the resolution of problems arising from health inspections. Other follow-up inspections shall be conducted only upon written application and payment of a fee as prescribed above.

HISTORY: Added by State Register Volume 16, Issue No. 6, eff June 26, 1992.

61-30. Environmental Protection Fees.

CONTENTS

- A. Purpose and Scope.
- B. Definitions.
- C. Payment of Fees.
- D. Penalties.
- E. Reporting.
- F. Appeals.
- G. Schedule of Fees.
- H. Time Schedules
- I. Compliance with Other Statutes and Regulations.
- J. Severability.

A. Purpose and Scope.

Pursuant to South Carolina Code Sections 48-2-50 (1993) and 48-39-145, the Department of Health and Environmental Control shall charge fees for environmental programs it administers pursuant to federal and state law and regulations. This regulation prescribes those fees applicable to applicants and holders of permits, licenses, certificates, certifications, and registrations (hereinafter, "permits") and establishes schedules for timely action on permit applications. This regulation also establishes procedures for the payment of fees, provides for the assessment of penalties for nonpayment, and establishes an appeals process to contest the calculation or applicability.

B. Definitions.

(1) "*Actual Emissions*" As pertains to Air Quality Control, the actual rate of emissions in tons per year of any regulated pollutant which was emitted over the preceding calendar year or any other period determined by the department to be representative of normal source operation. Actual emissions must be calculated using the unit's actual operating hours, production rates, and in-place control equipment, types of materials processed, stored, or combusted during the preceding calendar year or such other time period established by the department.

(2) "*Actual Flow*" means (a) aggregate flow as reported on the Discharge Monitoring Reports submitted for the previous year by Industrial dischargers; (b) flow limit as established by NPDES and ND permits for municipal and other non-industrial domestic dischargers.

(3) "*Adjudicatory Hearing*" means a trial-type proceeding conducted by the Department pursuant to the Department's Procedures for Contested Cases, as defined in R.61-72.101.

(4) "*Administratively Complete*" means a determination by the Department that all elements of an application, as specified in the applicable regulation and including but not limited to all required signatures and tender of the application fee, where required, have been received.

(5) "*Applicant*" means a person who applies for, or who is required to apply for a permit from the Department, or on whose behalf a permit application is made or required.

(6) “*Application*” means those forms supplied by the Department, properly completed, together with such technical reports, plans and specifications as may be required by statute or regulation to apply for a new permit; to renew an expired permit; or to request a major modification to an existing permit requiring substantial technical review by the Department.

(7) “*Consumer Price Index (CPI)*” The average of the Consumer Price Index for all-urban consumers published by the U. S. Department of Labor as of the close of the 12-month period ending on August 31 of each calendar year.

(8) “*Department*” means the Department of Health and Environmental Control.

(9) “*Environmental Protection Fund*” means a special agency-restricted, interest-bearing account established within the Treasurer’s Office in which is deposited all fees as authorized to be collected for the Department’s environmental programs.

(10) “*Minor activity*” As pertains to Coastal Zone Management Program, activities which are noncommercial/nonindustrial in nature and provide personal benefits that have no connection with a commercial/industrial enterprise. These include, but are not limited to, activities to construct such structures as private docks, bulkheads to prevent erosion of individual property, beachfront homes seaward of the baseline, and private boat ramps.

(11) “*Major activity*” As pertains to Coastal Zone Management Program, any construction activity that is not a minor activity. These include, but are not limited to, activities such as marina construction, construction of docks for commercial endeavors, dredging for navigation channels, pipeline construction, and beach renourishment projects.

(12) “*Permit Extension*” As pertains to Coastal Zone Management critical area permits, is the extension of an existing permit as allowed pursuant to Section 48-39-150(F) and R.30-4(D).

(13) “*Permit*” means any permit, license, certificate, registration, plan approval, variance, or other approval issued by or required by the Department or any of its divisions, pursuant to any statute or regulation.

(14) “*Permit Reissuance*” is the renewal of an existing permit, license, certification or registration at the end of or during the original period of the existing permit, license, certification or registration.

(15) “*Permitted Emissions*” As pertains to Air Quality, emissions of a regulated pollutant, as specified in a source’s air operating permit issued by the Department. Any physical or operational limitation on a source’s capacity to emit a pollutant, including air pollution control equipment and restrictions on hours of operation or on the type or amount of material combusted, stored, or processed, shall be considered in calculating total emissions.

(16) “*Permittee*” means any person authorized to conduct any activity or business pursuant to a valid permit issued by or filed with the Department.

(17) “*Person*” means any individual, trust, firm, public or private corporation or authority, partnership, association or other entity or any group thereof or any officer, employee, or agent thereof, including the State and the federal government and any agency or authority thereof, and including any city, town, county, or district of the State.

(18) “*Public Hearing*” A proceeding, properly noticed in accordance with applicable state and federal laws, during which comments are received and testimony is taken to establish a record of concern prior to an administrative action by the Department.

(19) “*Public Notice*” Notice of application or of proposed agency action published in accordance with applicable statutes and regulations.

(20) “*Regulated Pollutant*” As pertains to Air Quality, means the actual or permitted emissions from a source for each of the following compounds or substances:

(a) Except as provided for under G(2)(c), any pollutant regulated by Regulation 61-62.

(b) Volatile Organic Compounds.

(c) Except as provided for under G(2)(c), any pollutant for which a National Ambient Air Quality Standard has been promulgated.

(d) Any pollutant that is addressed by any standard promulgated under Section 111 or 112 of the 1990 Federal Clean Air Act or Regulation 61-62, Standard No. 8.

(21) "*Sources Subject to Fees*" As pertains to Air Quality Control, all sources operating under a permit issued by the Department.

(22) "*Time Schedules*" In accordance with S.C. Code Sections 48-2-70 and 48-39-150, a "schedule of timely review" for purposes of this regulation shall begin when the applicant is notified that the application is administratively complete or within ten days of receipt of the application, whichever comes first; and end when a final decision is rendered. It will include required technical review, required public notice, and end with a final decision by the Department to issue or deny the permit. The time schedule may be tolled or extended in accordance with the conditions stipulated in Section H(1) of this regulation.

(23) "*Transfer of permits*" As pertains to the Coastal Zone Management Program, means the written permission of the Department transferring a permit from one person to another.

C. **Payment of Fees.**

Application and other fees shall be paid in full as follows:

(1) Application fees:

(a) The Department may specify through the establishment of payment invoices, permit application forms, or other standardized instructions the form and manner of payment of all permit application fees.

(b) Application fees shall be due when the application is submitted. The Department will not process an application until the application fee is received.

(c) If the applicant withdraws the permit application anytime before or after the application has been deemed Administratively Complete, but prior to the Technical review of the application, the Department shall refund the entire application fee to the applicant.

(d) Once an applicant has been notified that the application has been deemed Administratively Complete, the Department shall issue or deny the permit within the time period established in Section H below; if no permit decision has been rendered by the end of the relevant time period, the application fee shall be refunded.

(2) Other Fees:

(a) The permit holder shall be notified of all fees other than application fees through routine invoicing schedules developed by the Department. All fees other than application fees are assessed on the state fiscal year of July 1 through June 30 of the following year. The holder of any valid permit on July 1 of each year will be assessed fees for the entire following fiscal period.

(b) New facilities permitted at any time during the fiscal year shall pay the entire annual operating fee prior to issuance of an operating permit except for those fees assessed pursuant to the Clean Air Act.

(c) All fees other than application fees are due within thirty days of billing. Unpaid fees, late fees, and returned checks are subject to the provisions of paragraph D below.

(d) Unless the permittee seeks an extension of the time for making payment, the permittee shall make payment in full on or before the date, and in the manner and form, specified in the invoice. Except to the extent authorized by the Department, late payment, nonpayment, partial payment, or failure to make payment in the specified manner and form shall constitute a failure by the permittee to pay the fee when due.

(3) All fees shall be payable to the Department of Health and Environmental Control and mailed to the Bureau of Finance, 2600 Bull Street, Columbia, S.C. 29201.

(4) Construction permits or modifications, revision, or reissuance of an operating permit will not be issued for a facility that is in default of fees due under this regulation.

D. **Penalties.**

(1) All fees other than application fees remaining unpaid thirty (30) days after billing will be issued a late notice with no penalty due; however, it will contain advisement of penalty for non-payment after sixty (60) days. Fees remaining unpaid after sixty (60) days will be assessed a ten percent (10%) penalty. Persons delinquent will be issued a notice of the ten percent (10%) penalty due the Department as well as advisement of further penalties should fees remain unpaid. Fees remaining unpaid at the end of ninety (90) days will be assessed a twenty five percent (25%) penalty in addition

to the ten percent (10%) sixty day penalty. The sum of both penalties may not exceed five thousand dollars. Persons delinquent at the end of ninety (90) days under this paragraph, will be notified by the Department by certified mail at their last known address.

(2) All returned checks will be subject to a returned check fee as outlined in the DHEC Administrative Policy and Procedures Manual. This penalty will be in addition to those outlined in Paragraph D(1).

(3) Failure to pay fees may, after a hearing in accordance with the provisions of Section F, result in the revocation of an existing permit, license, registration or certification.

E. Reporting.

A quarterly report will be made to the DHEC Board. The report shall include, but not be limited to, fees set and established under this regulation, changes made in the fee schedule since the last report, number of applications received and number of permits issued by each permitting program, adherence to the time schedules as listed in Section H., reduction, if any, in the backlog of permit applications awaiting review, the amount collected and expended by each fee source and any other information requested by the Board.

F. Appeals.

Any person required to pay a fee established pursuant to this regulation who disagrees with the calculation or applicability of the fee may submit to the Department a petition for a hearing together with the total amount of the fee assessed by the Department. The petition must comply with the requirements of Section 201 of Regulation 61-72 and must identify the fee which is challenged and set forth the grounds on which relief is sought. Such petition and the full amount of the fee due must be received by the Department no later than thirty days after the due date. The hearing shall be in accordance with Regulation 61-72, Procedures for Contested Cases, and the State Administrative Procedures Act. If, through the appeals process, it is determined that the fee was improperly assessed, the Department shall return the amount determined to be improperly assessed with interest not to exceed the statutory rate.

G. Schedule of Fees.

(1) Water Pollution Control.

(a) Annual Fees for NPDES and State Construction Permits and State Land Application Permits.

Annual operating fees for facilities with five or less pipes must be calculated based on the previous year's actual flow except for municipal separate storm sewer system (MS4) permits and coverage under a general permit. Annual operating fees for facilities with more than five pipes must be calculated based on the number of pipes except for municipal separate storm sewer system (MS4) permits and coverage under a general permit.

(i) Facilities with five or less discharge pipes:	
1. Flow greater than 4,999,000 gal/day	\$ 2,660
2. Flow 2,000,000 - 4,999,999 gal/day	\$ 2,130
3. Flow 1,000,000-1,999,999 gal/day	\$ 1,600
4. Flow 500,000-999,999 gal/day	\$ 1,330
5. Flow 100,000-499,999 gal/day	\$ 1,065
6. Flow 50,000-99,000 gal/day	\$ 800
7. Flow 0-49,999 gal/day	\$ 530
(ii) For six (6) or more discharge pipes	\$ 1,600
	plus \$800/discharge for each discharge
	pipe over five. (\$2,400 minimum charge).
(iii) Coverage under General Permit	\$ 100
(except for NPDES Storm Water General Permits)	
(iv) Municipal Separate Storm Sewer Systems	
1. Individual Permits	
a. Large MS4	\$ 25,000
(population equal to or greater than 250,000)	
b. Medium MS4	\$ 15,000
(population equal to or greater than 100,000 and less	
than 250,000)	
c. Small MS4	\$ 10,000
(population less than 100,000)	

2.	Coverage under a MS4 General Permit	\$ 2,000
(v)	Agricultural Facilities. Annual Fee will be based on maximum permitted capacity.	
1.	Swine Facilities	
a.	Facilities with a capacity of 1,000,000 pounds or more of normal production animal live weight at any one time	\$ 500
b.	Facilities with a capacity between 500,000 pounds and 1,000,000 pounds of normal production animal live weight at any one time	\$ 300
c.	Facilities with a capacity of less than 500,000 pounds of normal production animal live weight at any one time	\$ 150
2.	Other Animal Operations	
a.	Dry Manure/Litter Operations	\$ 75
b.	Wet Manure/Litter Operations	\$ 150
(vi)	Industrial NPDES Storm Water General Permit Coverage	\$ 75

(b) Water Quality Certification Application Fees.

(i)	Certification of major activities requiring federal or state permits	\$ 1,000
(ii)	Certification of minor activities requiring federal or state permits	\$ 100

(c) Construction Permit Fees.

(i)	Pretreatment Systems	
1.	For simple systems, such as one-component systems (e.g. oil/water separators, air strippers, PH control, etc.)	\$ 200
2.	Complex (such as Multi-Component) systems	\$ 600
(ii)	Collection Systems	
1.	Non-Delegated Program	
a.	1000 ft. or less	\$ 100
b.	1,001 to 9,999 ft.	\$ 200
c.	10,000 ft. or greater	\$ 350
d.	Pump stations with or without sewer lines (Fee exempt for individual, residential pumps)	\$ 350
2.	Delegated Project Review Program	\$ 75
(iii)	Wastewater Treatment Facilities. Fees for modifications without expansions will be assessed by the Department only for those modifications which require the actual submission of plans and specifications to the Department for review.	
1.	Facilities with a Flow of 1,000,000 GPD or greater	
a.	New	\$ 1,050
b.	Expansion	\$ 800
c.	Modification without Expansion (Engineering review required)	\$ 550
d.	Modification without Expansion (No Engineering review required)	NC
2.	Facilities with a Flow of 0-999,999 GPD	
a.	New	\$ 700
b.	Expansion	\$ 550
c.	Modification without Expansion (Engineering review required)	\$ 400
d.	Modification without Expansion (No Engineering review required)	NC
(iv)	Project submittals with both collection and treatment components pay the sum of the applicable collection and treatment fees under (i), (ii), and (iii) above.	
(v)	Construction NPDES Storm Water Permit	
1.	When the Department is the entity responsible for reviewing the Stormwater Pollution Prevention Plan submitted for review	\$ 125 Plus \$ 100 per disturbed acre

(not to exceed \$2000)

- 2. When an entity other than the Department is responsible for review of the Storm Water Pollution Prevention Plan and the entity's approval serves as a notice of intent for coverage under the general permit. \$ 125

(d) Agricultural Waste Management Plan Application.

- (i) New or Expanding Swine Facilities
 - 1. Facilities with a capacity of 1,000,000 pounds or more of normal production animal live weight at any one time \$ 2,500
 - 2. Facilities with a capacity between 500,000 pounds and 1,000,000 pounds of normal production animal live weight at any one time \$ 680
 - 3. Facilities with a capacity of less than 500,000 pounds of normal production Animal live weight at any one time \$ 340
- (ii) New * or expanding Other Animal Facilities
 - 1. Dry Manure/Litter Operation \$ 165
 - 2. Wet Manure/Litter Operation \$ 240
- (e) Industrial Storm Water 'No Exposure' Certification \$ 350

* includes conversion to another type of facility, i.e. poultry to swine.

(2) DHEC: Safe Drinking Water Act.

(a) In order to comply with the provisions of the federal Safe Drinking Water Act, the Department is authorized to collect a fee from each public water system. The fee must be based upon the number of taps through which the system provides water to its customers. The fees collected must be returned to the department for the purposes of implementing the Safe Drinking Water Act Regulatory Program including engineering plan review, compliance inspections, and enforcement; and for providing technical assistance and monitoring and laboratory analytical services for the public water systems of the State. The fee shall be as follows:

(i) Community and Non-Transient Non-Community Water Systems

Fee = Program Administration Component + Distribution Monitoring Component + Source Monitoring Component

Program Administration Component:

\$14.38 x (# Taps Up To 10) + \$9.60 x (# Taps From 11 To 25) + \$7.76 x (# Taps From 26 To 50) + \$5.75 x (# Taps From 51 To 100) + \$3.85 x (# Taps From 101 To 500) + \$2.88 x (# Taps From 501 To 1,000) + \$1.96 x (# Taps From 1,001 To 5,000) + \$1.44 x (# Taps From 5,001 To 10,000) + \$0.92 x (# Taps From 10,001 To 15,000) + \$0.46 x (# Taps From 15,001 To 25,000) + \$0.29 x (# Taps From 25,001 To 50,000) + \$0.17 x (# Taps From 50,001 To 100,000) + \$0.12 x (# Taps Greater Than 100,000)

Distribution Monitoring Component:

\$262.50 (Systems Serving Up To 100 Taps); Or,
 \$750.00 (Systems Serving 101 To 1,000 Taps); Or,
 \$3,750 (Systems Serving 1,001 To 15,000 Taps); Or,
 \$7,500 (Systems Serving Greater Than 15,000 Taps)

Source Monitoring Component:

[(\$250 x (#GW Sources)) + (\$500 x (#SW Sources))] (Up To 25 Taps); Or,
 [(\$450 x (#GW Sources)) + (\$800 x (#SW Sources))] (From 26 To 100 Taps);
 Or, [(\$1,250 x (#GW Sources)) + (\$1,800 x (#SW Sources))] (Greater Than 100 Taps); Or,
 [Maximum \$7,500]

Program Administration Component of Fee (Base Amount + Rate Per Tap)

<i>System Size</i>	<i>Base Amount</i>	<i>Rate Per Tap</i>
1 – 10	\$ 0	\$14.38 First 10 Taps
11 – 25	\$ 143.80	\$ 9.60 Taps 11–25

26 – 50	\$ 287.80	\$ 7.76	Taps 26–50
51 – 100	\$ 481.80	\$ 5.75	Taps 51–100
101 – 500	\$ 769.30	\$ 3.85	Taps 101–500
501 – 1000	\$ 2,309.30	\$ 2.88	Taps 501–1,000
1,001 – 5,000	\$ 3,749.30	\$ 1.96	Taps 1,001–5,000
5,000 – 10,000	\$ 11,589.30	\$ 1.44	Taps 5,001–10,000
10,001 – 15,000	\$ 18,789.30	\$ 0.92	Taps 10,001–15,000
15,001 – 25,000	\$ 23,389.30	\$ 0.46	Taps 15,001–25,000
25,001 – 50,000	\$ 27,989.30	\$ 0.29	Taps 25,001–50,000
50,001 – 100,000	\$ 35,239.30	\$ 0.17	Taps 50,001–100,000
100,001 and Above	\$ 43,739.30	\$ 0.12	Taps Over 100,000

DISTRIBUTION AND SOURCE MONITORING COMPONENTS OF FEE

<i>System Size (Number Of Taps)</i>	<i>Distribution Monitoring (Fixed Rate)</i>	<i>Source Monitoring (Rate per Source)</i>	
		<i>Ground Water</i>	<i>Surface Water</i>
1 – 10	\$262.50	\$ 250	\$ 500
11 – 25	\$262.50	\$ 250	\$ 500
26 – 50	\$262.50	\$ 450	\$ 800
51 – 100	\$262.50	\$ 450	\$ 800
101 – 500	\$ 750	\$1,250	\$1,800
501 – 1000	\$ 750	\$1,250	\$1,800
1,001 – 5,000	\$ 3,750	\$1,250	\$1,800
5,000 – 10,000	\$ 3,750	\$1,250	\$1,800
10,001 – 15,000	\$ 3,750	\$1,250	\$1,800
15,001 – 25,000	\$ 7,500	\$1,250	\$1,800
25,001 – 50,000	\$ 7,500	\$1,250	\$1,800
50,001 – 100,000	\$ 7,500	\$1,250	\$1,800
100,001 And Above	\$ 7,500	\$1,250	\$1,800

(ii) Other Public Water Systems

Transient Non-Community Syst	Fee = \$275
Systems Serving More Than 1 Tap But Less Than 15 Taps and Serving Less Than 25 People	Fee = \$175
Systems Serving 1 Tap and Serving Less Than 25 People	Fee = \$125
Vending Machines	Fee = \$75

(iii) For the purposes of this fee schedule, tap is defined as a service connection, the point at which water is delivered to the consumer (building, dwelling, commercial establishment, camping space, industry, etc.) from a distribution system, whether metered or not and regardless of whether there is a user charge for consumption of the water.

(iv) The Department shall submit an annual report to the Senate Finance Committee, House Ways and Means Committee, South Carolina Section American Water Works Association and the Municipal Association detailing activities funded from safe drinking water fees. The report shall include the amount of fees collected from each waterworks and the listing of expenditures from those fees. The expenditures shall be accompanied by a list of benefits the waterworks receive from the State as a result of the fees. In providing monitoring and laboratory analytical services, DHEC will consider least cost alternatives including contracting with private laboratories when appropriate. DHEC shall include all applicable direct and indirect costs in developing cost comparisons with private laboratories.

(v) Penalties. All fees remaining unpaid thirty (30) days after billing will be issued a late notice with no penalty due; however, it will contain advisement of penalty for non-payment after sixty (60) days. Fees remaining unpaid after sixty days will be assessed a ten percent (10%) penalty. Fees remaining unpaid at the end of ninety (90) days will be assessed a twenty-five percent (25%)

penalty in addition to the sixty day penalty. The Department may waive any or all of the assessed penalties in extenuating circumstances. The sum of both penalties may not exceed five thousand dollars. Persons delinquent under this paragraph will be notified by the Department by certified mail at their last known address.

1. All returned checks will be subject to a returned check fee as outlined in the DHEC Administrative Policy and Procedures Manual. This penalty will be in addition to those outlined above.

2. No monitoring will be conducted on systems with fees unpaid at the end of ninety (90) days.

(b) Construction General Permit (for Distribution Systems) Annual Fee. The annual fee is \$1,000.

(c) Construction Permit Application Fees

(i) Distribution systems and related components	
1. 1,000 feet or less of line	\$150
2. 1,001 feet to 9,999 feet	\$400
3. 10,000 feet or greater	\$600
4. Distribution storage/pump stations	\$600
(ii) Supply/Treatment from Groundwater Sources	
1. Well systems (test well)	\$500
2. Well systems, (follow-up, including well head piping, storage	\$500
3. Well systems (one step)	\$1,000
4. Treatment systems (except for chemical feed systems)	\$500
5. Chemical feed systems	\$250
6. Small water system permits	\$250
(iii) Supply/Treatment from Surface Water Sources	
1. New treatment plants	\$2,000
2. Expansions of existing facilities	\$1,500
3. Modifications or addition of components	\$1,000
4. Plant storage, pumping and piping facilities	\$500
5. Chemical feed systems	\$250
(iv) Drinking Water Dispensing Stations/Bottled Water Plants (using distribution water)	\$500
(v) General Permit (which may include Delegated Review Program Approval)	
1. Application for permit (not a renewal)	\$1,000
2. Delegated review permit	\$75
(vi) Permit extensions	\$50

(3) Air Quality.

(a) General.

(i) The fees assessed are those fees sufficient to cover reasonable costs associated with the development, processing, and administration of the Title V air quality program. Such costs are defined as those necessary to administer the permit program, the Small Business Stationary Source Technical and Environmental Compliance Assistance Program, support staff, equipment, legal services, contracts with consultants and program expenses listed in Section 502(b)(3)(a) of Title V of the 1990 amendments to the Federal Clean Air Act.

(ii) Fees collected shall be placed in a separate non-reverting account within the Department to be used exclusively for the expenses in Section G(3)(a)(i).

(iii) Except as provided in Section F of this regulation, fees are non-refundable.

(iv) Types of permits used in Table 1 below refer to the Definitions used in Regulation 61-62.1.

(v) All sources are subject to the fee schedule in paragraph (b) below. All sources subject to Title V requirements under Regulation 61-62.70 are also subject to the fee schedule in paragraph (c) below.

(b) Annual Fee. The source owner or operator must pay an annual permit fee to the Department. Beginning on July 1, 1994, and for each subsequent year, fees will be as follows:

(i) \$25.00 per ton (plus Consumer Price Index (CPI) adjustment) of regulated pollutant based on the actual emissions for the preceding calendar year or any other period determined by the

Department to be representative of normal source operation. The CPI adjustment is that percentage of \$25.00/ton equal to the percentage, if any, by which the CPI for the most recent calendar year ending before the beginning of such year exceeds the CPI for 1989.

(ii) New sources or any source without sufficient data to be able to determine actual emissions must be assessed the above \$25.00 a ton fee with appropriate CPI adjustment calculated on a pro rata basis for their months of operation. The fee must be based on permitted emissions, until such time as “Actual emissions” can be calculated, and must be paid before the operating permit is issued.

(c) Annual Title V Program Maintenance Fee. The owner or operator of a source subject to the Title V requirements under Regulation 61–62.70 will be assessed the following annual maintenance fee set forth in Table 1 and based on actual emissions as determined in paragraph (3)(b) above.

Actual Emission Level	Fee
< (less than) 10 tons	\$500.00
10 tons to 50 tons	\$1,000.00
> (greater than) 50 tons to 100 tons	\$2,000.00
> (greater than) 100 tons to 250 tons	\$3,500.00
> (greater than) 250 tons to 1,000 tons	\$6,500.00
> (greater than) 1,000 tons	\$10,000.00

(d) Should funds in the non-reverting account exceed the anticipated budgeted expenditures for the following year, the fee described in Section G.3.b(i) and (ii) and G.3.c. above may be adjusted by the Board. At no time shall this adjustment cause a depletion of funds to a level less than ten percent (10%) of the previous year’s expenditures for the Title V permitting requirements of the 1990 Federal Clean Air Act. Any adjustment of fees will require a public hearing to propose the adjustment prior to a final decision by the Board.

(e) Exceptions.

(i) No fees will be assessed for emissions of carbon monoxide.

(ii) No fee will be assessed for actual or permitted emissions in excess of 4,000 tons/year per pollutant.

(iii) The Department may exclude, from the fee calculations, insignificant quantities of actual emission not required in a permit application pursuant to Regulation 61-62.70.5(c).

(4) Laboratory Certification Services:

(a) Application Fee	\$	125
(b) Minimum Annual Fee (per laboratory)	\$	125
(c) Clean Water Act (CWA) Inorganics per parameter	\$	20
(d) Safe Drinking Water Act (SDWA) Inorganics per parameter	\$	20
(e) SDWA “Secondary” Inorganics per parameter	\$	20
(f) CWA Organics:		
(i) PCBs and Pesticides	\$	350
(ii) Herbicides	\$	350
(iii) Volatiles	\$	350
(iv) Semi-Volatiles	\$	350
(v) Dioxins and Furans	\$	350
(g) SDWA Organics:		
(i) Trihalomethanes	\$	350
(ii) Organic Compounds	\$	350
(iii) Volatiles	\$	350
(h) Microbiology:		
(i) Total Coliform	\$	75
(ii) Fecal Coliform	\$	75
(iii) Fecal Streptococci	\$	75
(i) Biology		

(i)	Toxicity Testing	\$	500/ Species
(ii)	Taxonomy	\$	250
(j)	Solid and Hazardous Wastes (SW-846 Methods):		
(i)	Inorganics (per parameter)	\$	20
(ii)	Organics (per parameter group)	\$	350
	Note: SW-846 certification fees shall be capped at \$1,500 for those laboratories which have paid the applicable per-parameter fees for CWA tests.		
(k)	Air Quality Analysis:		
(i)	Inorganics (per parameter)	\$	20
(ii)	Organics (per parameter group)	\$	350
	Note: Air Quality Certification fees shall be capped at \$1,500 for those laboratories which have paid the applicable per-parameter fees for CWA tests.		

(5) Radioactive materials licenses including reciprocity and general licenses specified in R.61-63.

(a)	Low-Level Radioactive Waste Shallow Land Disposal	\$	600,000
(b)	Low-Level Waste Interim On Site Storage & Processing:		
(i)	Solid Components Only	\$	7,500
(ii)	Combination Waste Streams	\$	15,000
(c)	Low-Level Waste Processing Services:		
(i)	Less than 200 FT ³ /year	\$	15,000
(ii)	Greater than 200 FT ³ /year	\$	75,000
(d)	Low-Level Waste Consolidation Services	\$	37,500
(e)	Decontamination, Recycling, Pilot Study Services & Contaminated Equipment Storage (Non-Waste)	\$	4,500
(f)	Decommissioned Facility:		
(i)	Test Reactor	\$	750
(ii)	Non Fuel Cycle	\$	750
(iii)	Fuel Cycle	\$	7,500
(g)	Natural Occurring from Processes	\$	750
(h)	Radioactive material Manufacturing/Processing	\$	40,500
(i)	Irradiator (unshielded)	\$	5,994
(j)	Irradiator (Self-contained)	\$	313
(k)	Large Quantity Source Material	\$	1,250
(l)	Industrial Radiography (In-Plant only)	\$	1,119
(m)	Industrial Radiography (Temporary Field Site)	\$	1,344
(n)	General License for Distribution	\$	806
(o)	Medical Institution	\$	707
(p)	Teletherapy	\$	1000
(q)	Industrial Gauges	\$	344
(r)	Laboratories-Commercial/Medical	\$	325
(s)	Educational Institution	\$	407
(t)	Nuclear Pharmacy	\$	1,244
(u)	Medical Private Practice	\$	588
(v)	Moisture/Density Gauge	\$	325
(w)	Gas Chromatograph	\$	188
(x)	Services Consultants	\$	207
(y)	Bone Mineral Analyzer	\$	432
(z)	Eye Applicator	\$	432
(aa)	Medical/Academic Broad License	\$	2,313
(bb)	Well Logging	\$	1,125
(cc)	Mobile Scanning Services	\$	675
(dd)	Decontamination/Nuclear Laundry	\$	4,375
(ee)	All Other	\$	338

(6) Radioactive Waste Transportation Permits.

- (a) Type X - Annually greater than 75 cubic feet \$2,500
- (b) Type Y - annually less than 75 cubic feet \$300
- (c) Type Z - Combination X or Y but not for disposal within State-Transport only \$100

(7) Radioactive Material fees for review and approval of special projects, topical reports, on site disposals, permits, licenses, amendments, renewals and inspections that are not covered by the above schedule, but are based on the full cost recovery for the review or inspection, will be calculated using a professional staff-hour rate equivalent to the sum of the average cost to the agency for a professional staff member, including salary and benefits, administrative support, travel, and certain program support. The professional staff-hour rate will be based on the applicable fiscal year budget but would not exceed one hundred dollars per hour.

(8) Hazardous and Mixed Waste.

Annual Operating Fee \$ 600

(9) Public Swimming Pool Fees.

(a) Construction Permits.

(i) Type "A", "B", "C", "D", and "F" Pools - \$400 plus \$0.50 per square foot of surface area.

(ii) Type "E" Pools - \$1,000 per flume (including minimum required design landing area) or water course, to include water slide. Additional area above minimum required landing area and all other Type "E" pools will be charged according to (i) above.

(iii) The Department may collect an additional \$250 from the owner for each repeat final inspection that is required due to incomplete construction or construction that is not in accordance with permitted plans and specifications.

(b) Annual Operating Permits.

(i) Type "A", "B", "C", "D" and "F" Pools - \$125 for the first pool on a property plus \$100 for each additional pool on the same property.

(ii) Type "E" Pools - \$100 per flume or water course.

(10) Individual Residential Wells and Irrigation Wells. In accordance with R.61-44, Permitting of Individual Residential Wells and Irrigation Wells, the Department is authorized to collect a fee for each application to install an individual residential well and irrigation well. The fee collected must be returned to the Department for the purposes of developing and implementing the Individual Residential Well and Irrigation Well program, including proposed well construction review, compliance inspections, technical assistance, enforcement, and for providing bacteriological analytical services for new individual residential wells. The fee shall be as follows:

- (a) Individual Residential Well \$ 70
- (b) Irrigation Well \$ 50

(11) Individual Residential Well Monitoring - These fees are to be charged for water samples collected by individuals from their residential well and submitted to the Department for analysis. These fees will not be charged if the samples are considered part of a Department groundwater contamination investigation and may be waived or reduced based on the individual's ability to pay. Ambient water samples and samples from public water systems will not be accepted and analyzed.

- (a) Total or Fecal Coliform \$ 20 per test
- (b) Metals and Minerals \$ 50 per sample
- (c) Other Inorganic Parameters \$ 25 per parameter
- (d) Volatile Organic Chemicals \$ 50 per sample
- (e) Herbicides, Pesticides, and other Synthetic Organic Parameters \$ 50 per parameter

(12) Infectious Waste Annual Fees.

- (a) Generators of 1000 pounds per month or more. \$ 600

- (b) Generators of 50 pounds per month through 999 pounds per month \$ 150
- (c) Transporters \$ 500

(13) Coastal Zone Management Program

- (a) General.
 - (i) The fees assessed are those fees sufficient to cover a portion of the reasonable costs associated with the development, processing, and administration of the Coastal Zone Management Program.
 - (ii) Fees collected shall be placed in a separate non-reverting account within the Department to be used exclusively for the expenses in G(13)(a)(i), except for the amounts dedicated to the Coastal Resources Access Fund (CRAF). DHEC-OCRM shall make matching grants from the fund on a 50/50 basis to local governments in the South Carolina Coastal Zone for projects which enhance the public's use and enjoyment of coastal resources. A portion of the funds collected as per G(13)(b) shall be dedicated to the CRAF.
 - (iii) Local governments will only be charged the fee for a minor activity and State agencies will not be charged.
- (b) Critical Area Permit Application Fees
 - (i) Minor activity: \$250.00, except for docks 100 feet or less in length for which the fee will be \$150.00
 - (ii) Major activity: \$1000.00
 - (iii) Extensions or transfers of minor permits: \$25.00
 - (iv) Extensions or transfers of major permits: \$100.00
 - (v) Amendments for minor permits which must be placed on public notice: \$100.00
 - (vi) Amendments for major permits which must be placed on public notice: \$1000.00

(14) Oil and Gas Annual Fees

Terminal Facility Registration Fees \$250.

H. Time Schedules.

(1) General

(a) All times given in days are given in calendar days. The last day of the period is to be included, unless it is a Saturday, Sunday, or legal holiday, in which case the period runs until the end of the next day which is not a Saturday, Sunday or legal holiday. With respect to permit reissuance, the schedule for timely action shall apply only if the applicant so elects and notifies the Department in writing.

(b) The day notice is mailed to the applicant that the application is deemed administratively complete shall be counted. If notice that the application is Administratively Complete or notice that the application is not Administratively Complete, together with notice of the specific items deemed to be lacking, is not mailed to an applicant within ten (10) working days of receipt of an application, the time period will begin.

(c) The time schedule shall be tolled when the Department makes a written request for additional information and shall resume when the Department receives the requested information from the applicant. If an applicant fails to respond to such a request within 180 days, the Department will consider the application withdrawn and the application fee will be forfeited. The Department shall notify the applicant no later than 10 days prior to expiration of the 180-day period.

(d) The time periods given in Section H.2 shall be stayed if:

- (i) The applicant requests that permit review be suspended;
- (ii) The Department at least ten days prior to the expiration date, requests a delay in the review process to which the applicant agrees;
- (iii) The Department is requested to hold a public hearing, in which case the time schedule will be tolled for no more than 60 days.

(e) Change in Project.

(i) Determination of Change. The Department may determine that the applicant has filed a new application whenever additional information provided by the applicant during any Departmental review period, in response to any statement identifying deficiencies in the application or supporting materials, or during any period allowed for public comment, either:

1. results in a change in the category in which the permit application is classified, or;
2. significantly increases or changes the nature of the potential effects of the proposed project or activity on public health and safety or the environment. Upon making a determination that the applicant has filed a new application, the Department shall promptly notify the applicant in writing. The notice shall indicate the basis for the determination and summarize the provisions relative to such determinations. The determination that a project has changed shall not be grounds for a request for adjudicatory hearing; however, an applicant aggrieved by such a determination may seek review of the determination as an issue in any appeal of the permit decision.

(ii) Effects of determination on schedule.

1. Immediately upon issuance of the notification, the schedule for timely action shall be suspended.
2. If the determination resulted from a proposed change in design or operation of the proposed project or activity the applicant may, within 30 days, withdraw the change and return to its previous proposal by so notifying the Department in writing. If the applicant so notifies the Department, the schedule for timely action shall resume at the point at which it was suspended.
3. If the determination resulted from any other cause, or if the applicant does not elect to withdraw the change; the Department shall begin a review of the new application pursuant to the relevant schedule for timely action.

(iii) Effects of determination on fee. Unless the applicant elects to proceed with the previous application the original application shall be deemed withdrawn, and the fee shall be forfeited; provided, that the Department shall credit any amount to be refunded toward the permit application fee payable for the new permit unless the applicant requests a refund.

(f) Extension of schedule by other actions.

(i) Failure of payment. Whenever a check or other form of payment of an application fee is returned for insufficient funds, or if payment in full is in any other manner prevented, the schedule for timely action shall be suspended. The department shall notify the applicant of such suspension in writing.

(g) Extension of periods for Departmental action.

(i) The time periods for the Department to take any action shall be extended whenever action by another federal, state, or municipal governmental agency is required before the Department may act, or judicial proceedings then underway affect the ability of the Department or the applicant to proceed with the application, or when the Department has commenced enforcement proceedings which could result in revocation of an existing permit for that facility or activity and denial of the application. The applicant shall promptly notify the Department in writing whenever it believes that action by another governmental agency is required, or that judicial proceedings affect the ability of the Department or the applicant to proceed with the application.

(ii) The Department shall provide written notice to the permit applicant within ten (10) days of making a determination that an extension is necessary. Such notice shall contain a statement of the reasons for which the schedule must be extended.

(iii) When the Department determines that the reason for such extension is no longer applicable, the Department shall so notify the applicant in writing within ten (10) days of making such determination. The time period for the Department to complete the a timely review shall begin on the day the notice is mailed.

(2) Environmental Permit.

(a) Water Pollution Control:

(i) New/increased capacity NPDES or land application permits	180 Days
(ii) Construction Permit for new treatment plant or expansion with increased volume, mass loading, or loading, or addition of pollutant to be controlled.	120 Days (or 20 Days beyond effluent discharge permit issuance, whichever is greater)
(iii) Construction Permit for treatment plant upgrade (without expansion and no change in effluent discharge permit limits)	90 Days
(iv) Construction permit for pre-treatment system	90 Days
(v) Construction Permit for sewer systems (including pump stations and force main systems)	60* Days *Add 45 days if separate navigable waterway permit is applicable
(vi) Storm water discharge under General Permit	7 Days
(vii) Water Quality Certification	180 Days
(b) Agricultural Waste Management Plan Application	
(i) Swine Facilities	
1. Facilities with a capacity of 420,000 pounds or more of production animal live weight at any one time	120 Days
2. Facilities with a capacity of less than 420,000 pounds of normal production animal live weight at any one time	90 Days
(ii) Other Animal Facilities	
1. Dry Manure/Litter Operation	90 Days
2. Wet Manure/Litter Operation	120 Days
(c) Air Quality:	
(i) Construction permit	90 Days (Except for permits issued under the NESHAP Regulation [R.61-62.63] which provides 105 days for permit issuance.)
(ii) Operating permit	90 Days
(iii) PSD Construction Permit	270 Days
(iv) Title V Operating Permit	540 Days
(d) Laboratory Certification:	
(i) Initial certification	90 Days
(e) Radioactive Materials licenses:	
(i) New license - on-site disposal, broad license	30 Days
(ii) New license - storage/treatment	180 Days
(iii) License renewal - annual	30 Days
(iv) Transporter permit	10 Days
(f) Hazardous and Mixed Waste Management:	
(i) Commercial Hazardous Waste Facilities	990 Days
(ii) Non-Commercial Hazardous Waste Facilities	540 Days

Applications for permit modifications which add or delete units or which change the capacity of permitted units will be processed within The time schedules above.

- (g) Solid Waste Management.
- (i) Municipal Solid Waste Landfill Permit:
1. Solid Waste Landfill Siting Study:
 - a. Preliminary Hydrogeologic Characterization Report 60 Days
 - b. Site Hydrogeologic Characterization Work Plan 90 Days

c.	Site Hydrogeologic Characterization Report	120 Days
2.	Permit Application	360 Days
(ii)	Industrial Solid Waste Landfill Permit:	
1.	Solid Waste Landfill Siting Study:	
a.	Preliminary Hydrogeologic Characterization Report	60 Days
b.	Site Hydrogeologic Characterization Workplan	90 Days
c.	Site Hydrogeologic Characterization Report	120 Days
2.	Permit Application	360 Days
(iii)	Municipal Incinerator Ash Landfill Permit:	
1.	Solid Waste Landfill Siting Study:	
a.	Preliminary Hydrogeologic Characterization Report	60 Days
b.	Site Hydrogeologic Characterization Workplan	90 Days
c.	Site Hydrogeologic Characterization Report	120 Days
2.	Permit Application	360 Days
(iv)	Municipal Solid Waste Incineration Permit	180 Days
(v)	Construction, Demolition and Land-Clearing Debris Landfill Permit	120 Days
(vi)	Waste Tire Permit (Processing, Collection and Disposal Permit)	90 Days
(vii)	Waste Tire Hauler Registration	30 Days
(viii)	Transfer Station Permit	90 Days
(ix)	Research, Development and Demonstration Permit	90 Days
(x)	Municipal Solid Waste Processing Permit	90 Days
(xi)	Lead-Acid Battery Facility Registration	30 Days
(xii)	Yard Trash Composting Facility Registration	30 Days
(h)	Infectious Waste Management:	
(i)	Treatment facility	270 Days
(ii)	Intermediate handling facility	270 Days
(i)	Drinking Water Permits:	
(i)	Drinking Water Construction	45 Days
(ii)	Recreational Waters	15 Days
(iii)	UST Construction Permit 15 Days In Coastal Zone	45 Days
(iv)	UST Operating Permit	10 Days
(v)	UIC Construction Permit	60 Days
(vi)	UIC Operating Permit	45 Days

(j) Individual Residential Wells and Irrigation Wells (issued under a general permit with the 48-hour period calculated from the time and date of receipt of the Notice of Intent excluding weekends and legal state holidays):

(i)	Individual Residential Well	48 Hours
(ii)	Irrigation Well	48 Hours

(3) Coastal Zone Management Program.

(g) Solid Waste Management.

(a) Critical Area Permits

- (i) Minor activities: 30 days
- (ii) Major activities: 90 days
- (iii) Extensions or transfers of minor activity permits: 15 days
- (iv) Extensions or transfers of major activity permits: 30 days
- (v) Amendments of minor activity permits: 30 days
- (vi) Amendments of major activity permits: 90 days

I. Compliance with Other Statutes and Regulations.

Nothing in this regulation shall relieve the applicant of the duty to comply with all other applicable environmental statutes and regulations.

J. Severability.

Should any section, paragraph or other part of these regulations be declared invalid for any reason, the remainder shall not be affected.

HISTORY: Added by State Register Volume 19, Issue No. 6, eff June 23, 1995; Amended by State Register Volume 22, Issue No. 6, Part 2, eff June 26, 1998; State Register Volume 23, Issue No. 6, eff June 25, 1999; State Register Volume 25, Issue No. 2, eff February 23, 2001; State Register Volume 26, Issue No. 6, Part 1, eff June 28, 2002; State Register Volume 28, Issue No. 3, eff March 26, 2004; State Register Volume 29, Issue No. 3, eff March 25, 2005; State Register Volume 30, Issue No. 6, eff June 23, 2006; State Register Volume 32, Issue No. 5, eff May 23, 2008; State Register Volume 36, Issue No. 2, eff February 24, 2012; State Register Volume 38, Issue No. 6, Doc. No. 4460, eff June 27, 2014.

61–31. Health Care Cooperative Agreements.

CHAPTER 1 PURPOSE, DEFINITIONS, APPLICABILITY

SECTION 101. Purpose:

These Regulations implement the legislative intent that there be a state regulatory program to permit and encourage cooperative agreements between hospitals, health care purchasers, or other health care providers which would otherwise violate federal or state anti-trust laws when the benefits outweigh disadvantages caused by their potential adverse effects on competition.

This is encouraged because the cost of improved technology and scientific methods contribute significantly to the increasing cost of health care; and cooperative agreements among hospitals, health care purchaser, and other health care providers will foster improvements in the quality of health care for South Carolinians.

SECTION 102. Definitions:

As used in this regulation:

- 1) “Affected persons” means a health care provider or purchaser:
 - a) who provides or purchases the same or similar health care services in the geographic area served or to be served by the applicants for a Certificate of Public Advantage: or
 - b) who has notified the Department of his interest in applications for Certificates of Public Advantage and has a direct economic interest in the decision. Other than health insurers licensed in South Carolina, persons from other states who would otherwise be considered “affected persons” are not included unless that state provides for similar involvement of persons from South Carolina in a similar process in that state.
- 2) “Certificate of Public Advantage” mean the formal approval, including any conditions or modifications, by the Department of a contract, business or financial arrangement, or other activities or practices between two or more health providers, health provider networks, or health care purchasers that might be construed to be violations of state or federal laws.
- 3) “Cooperative agreement” means an agreement between two health care providers, health provider networks, or health care purchasers or among more than two health care providers, health provider networks, or health care purchasers for the sharing, allocation, or referral of patients or the sharing or allocation of personnel, instructional programs, support services and facilities, medical, diagnostic or laboratory facilities, procedures, equipment, or other health care services traditionally offered by health care facilities or other health care providers or the acquisition or merger of assets among or by two or more health providers, health provider networks or health care purchasers, provided the agreement does not involve price-fixing or predatory pricing or illegal tying arrangements.
- 4) “Department” means the Department of Health and Environmental Control.
- 5) “Health care provider” means a health care professional licensed, certified, or registered under the laws of this State, an organization licensed pursuant to Section 44-69-30 or Section 44-71-30, or a facility licensed pursuant to Section 44-7-260 or Section 44-89-40 to provide health care services or any other person as defined in Section 44-7-130(15) who provides health services in a freestanding or mobile facility.
- 6) “Health care purchaser” means a person or organization that purchases health care services on behalf of an identified group of persons, regardless of whether the cost of coverage of services

is paid for by the purchaser or by the person receiving coverage or services, including but not limited to:

- a) health insurers as defined by Section 38-71-92;
 - b) employee health plans offered by self-insured employers;
 - c) group health coverage offered by fraternal organizations, professional associations, or other organizations;
 - d) state and federal health care programs; and
 - e) state and local public employees health plans.
- 7) "Health provider networks" means an organization of health care providers which offers health services to a resident of this State. An organization may be a partnership, corporation including an association, a joint stock company, or any other legal entity recognized by the State.
- 8) "Health service area" means the proposed primary service area of all facilities or entities involved in the cooperative agreement.
- 9) "Federal or state antitrust laws" means a federal or state law prohibiting monopolies or agreements in restraint of trade, including the Federal Sherman Act and Clayton Act, the Federal Trade Commission Act, and Chapters 3 and 5 of Title 39 of the 1976 Code.
- 10) "Party" or "Party to a cooperative agreement" means a person who negotiates or enters into a cooperative agreement.
- 11) "Person" means an individual, a trust or estate, a partnership, a corporation, an association, a joint stock company, an insurance company, a health maintenance organization, a state, a political subdivision of a state, an instrumentality including a municipal corporation of a state, or any legal entity recognized by the State.
- 12) "A complete application" means a Questionnaire [page 15 of these Regulations] with all applicable questions answered, and a narrative addressing each point set out in Section 202, and any additional information requested by the Department pursuant to Section 302.
- 13) "Receipt" means actual receipt of a written document.

SECTION 103. Applicability:

This regulation applies to health care providers, health care networks, and health care purchasers who apply for a Certificate of Public Advantage and to those who receive a Certificate of Public Advantage.

The issuance of a Certificate of Public Advantage is not required in order for health care providers, purchasers or networks, to negotiate and enter into cooperative agreements with other health care providers. Parties to a cooperative agreement may apply to the Department for a Certificate of Public Advantage, should they desire.

CHAPTER 2 APPLICATION

SECTION 201. Application Submission:

Two copies of the application shall be forwarded to the Department in the format described in Section 202. The application shall be on 8 ½ × 11 paper, one side only, and three hole punched on the left side.

SECTION 202. Application:

In answering the following questions, the applicants may refer to specific sections of the executed cooperative agreement in lieu of repeating the required information.

For each response for which confidentiality has been sought pursuant to Section 310, include the following statement: "Submitted separately under claim of confidentiality."

An application shall consist of:

- (a) PART A. Questionnaire.

QUESTIONNAIRE
PART A.

Parties To The Cooperative Agreement

Name	Title	Address
1.		
2.		
3.		
4.		
5.		

Brief Description of Proposal

Describe Proposed Market Area

Person Responsible For This Application	Title
Address	Telephone Number

All parties hereby certify that the information contained in this Application, including all assurances and attachments, are accurate and correct to the best of our knowledge and belief.

Signature _____ Date _____

(b) PART B. Narrative

1.(A) Describe the agreement in detail, including all the parties and each party's responsibilities, obligations and commitments.

(B) State whether the project will change the existing services of a health care provider.

(C) Describe any shared services.

(D) Describe any obligation for future commitments or negotiations.

(E) Describe the nature and scope of the cooperation that is required by each party to the agreement.

(F) Describe in detail any monetary or other consideration passing to a party under the cooperative agreement.

(G) Describe in detail any merger, lease, change of ownership or other change in control of the assets of any party to the cooperative agreement.

2. Provide the total cost of the project and the costs to be incurred by category. Examples include but are not limited to consultants, capital costs, and management costs. Describe what part of the cost is borne by each party.

3. Provide the following ownership disclosure for each party in the agreement.

(A) The name of the party;

(B) Address of each party;

(C) The complete title of the governing body (if any);

(D) The name, title and address of the presiding officer of the governing body;

(E) The name and mailing address of all persons and/or entities having 5% or more ownership interest or owner's equity of any of the parties to include a schedule of percent and type ownership of each;

(F) A list of all officers of each party;

(G) A copy of any agreement, contract, option, understanding, intent or other arrangement that will effect a change in any of the information provided in subparagraphs (A) through (F)

above. If such an agreement exists, provide similar information for the party after the terms of the arrangement are carried out; and

(H) If any of the licensees of the cooperative agreement are a subsidiary corporation, provide a diagram of the licensee's relationship to the parent corporation and list the name and address of the parent corporation.

4. Demonstrate and document that the likely benefits accruing from the cooperative agreement outweigh the likely disadvantages. At a minimum, include the economic, administrative, and patient impact of the agreement. Describe how the cooperative agreement will foster cost containment, eliminate duplicate services or otherwise positively impact the health care system. Describe how the cooperative agreement will reduce competition, reduce patient choice, or otherwise negatively impact the health care system.

5. Discuss alternatives that have been considered and the advantage and disadvantages of each alternative.

6. Discuss any improvements in access and any problems patients may experience, such as costs, availability, or accessibility, upon initiation of the proposed cooperative agreement.

7. Identify any costs associated with implementation of the cooperative agreement and provide documentation of the availability of the necessary funds.

8. Describe the current service area of each party to the cooperative agreement and describe the proposed service area upon initiation of the cooperative agreement.

9. Describe the current market share of each party to the cooperative agreement and describe the proposed market share upon initiation of the cooperative agreement.

10. Provide a current annual budget for each party involved in the cooperative agreement and a three year projected budget for all entities after the initiation of the cooperative agreement. The budgets must be in sufficient detail so as to determine the fiscal impact of this cooperative agreement on each party. The budgets must be prepared by a Certified Public Accountant (CPA) and all assumptions used must be shown.

11. Document that the proposed agreement is economically feasible both immediately and long term. Describe the impact that the cooperative agreement will have on costs per unit of service.

12. Describe how the agreement enhances or restricts health care services to Medicaid, indigent or charity patients.

13. Provide the name, address and telephone number of the individual who should be contacted for monitoring the implementation of this agreement.

14. Provide a timetable for implementing all components of the cooperative agreement.

15. Provide any additional information that would assist the Department in evaluating this cooperative agreement.

(c) Part C. Programmatic Documents

1. An executed copy of the negotiated cooperative agreement between all parties; or

2. A written copy of the negotiated cooperative agreement and documentation that the proposed subject has been approved by the governing body of each party.

(d) Part D. Assurances

The parties must furnish written assurance of each of the following:

1. that the parties will submit to the Department for approval any changes that occur to the approved cooperative agreement;

2. that the parties will carry out the agreement in accordance with the approved application;

3. that the parties understand that the Department may revoke a Certificate of Public Advantage at any time for reasons outlined in Section 503 of these regulations;

4. that the Department or its authorized representatives at any time during normal hours of operation shall be allowed to make an on-site inspection to determine compliance in accordance with the application for which the Certificate of Public Advantage was issued;

5. that the parties will cooperate with the Department or any investigation regarding compliance with the application for which the Certificate of Public Advantage was issued by providing relevant information in a timely manner, assisting in the collection of data, or satisfying other relevant requests from the Department;

6. that the parties will submit at least every two years, the information required by Section 502 of these regulations;

7. that this cooperative agreement does not involve price fixing, predatory pricing or illegal tying arrangements;

8. that the parties understand that the issuance of a Certificate of Public Advantage does not exempt any of the parties from compliance with the provisions of *Regulation 61-15, Certification of Need for Health Facilities and Services*.

CHAPTER 3 DISPOSITION OF APPLICATION

SECTION 301. Submission of Application:

Two copies of the application, and the filing fee set forth in Section 509 shall be submitted to the Bureau of Health Facilities and Services Development, S.C. Department of Health and Environmental Control, 2600 Bull Street, Columbia, SC 29201.

SECTION 302. Additional Information:

(A) After receipt of an application and the appropriate filing fee, the Department will review the application. The Department may request additional information within thirty days of receipt of the application. The applicant will have thirty days from the date of the request to submit the additional information.

(B) If the additional information submitted in response to the Department's request is incomplete, the Department will have fifteen (15) days in which to request further information. If information necessary to deem the application complete is not submitted within thirty (30) days of the second request, the application will be considered withdrawn. An application that is withdrawn does not preclude the applicant from resubmitting a new application.

(C) An application is complete when the Department notifies the applicant that all necessary information has been received or when no request for additional information has been made within thirty days of receipt of the original application.

SECTION 303. Notice and Opportunity for Public Hearing:

(A) Upon receipt of an application and the appropriate filing fee the Department shall publish in the State Register a notice of the receipt of the application.

(B) An affected person as defined in these regulations who requests a public hearing must do so in writing within thirty days of notice pursuant to Section 304 that a completed application has been received by the Department.

(C) The Department will determine whether a public hearing will be held; grounds for denying a public hearing include, but are not limited to, a finding that the requestor is not an affected person. When such a public hearing is held, thirty days prior notice of the hearing will be provided to affected persons. The written notification of the hearing shall include the proposed schedule for review, time, date and place of the public hearing. The public hearing shall provide an opportunity for any person to present information relevant to the application.

SECTION 304. Notification of Affected Persons:

Upon the Department's determination that an application is complete, the Department shall publish in a newspaper having general circulation in the area a public notice that the cooperative agreement application is complete, and when affected persons may request a public hearing. The public notice shall run three consecutive days. Any affected person who has requested in writing to be notified of the determination of the completeness of an application shall be notified in writing by the Department.

SECTION 305. Review by the S.C. Attorney General:

Upon receipt of a completed application, the Department shall forward a copy of the application to the S. C. Attorney General. After review in accordance with SC Code § 44-7-550, the Attorney General may advise the Department in writing to approve or deny the application. If no report is

received from the Attorney General within thirty days, the Department will consider that as a recommendation to approve the request. If the Attorney General recommends denial of the Certificate of Public Advantage, the Department will consider the reasons therefor. The Attorney General's opinion is advisory and DHEC is responsible for rendering the final decision.

SECTION 306. Review Time Frames:

The Department must make a decision on the complete application within 60 days of the receipt of a complete application or notification to the applicant that an application is complete, if additional information has been requested, or within sixty days of any public hearing, whichever is later.

SECTION 307. Department Decision:

On the basis of staff review of the record established by the Department, including but not limited to comments from the Attorney General's office, the application, written and verbal comments by affected persons and other persons concerning the application, data studies, literature and other information available to the Department, the staff of the Department shall make a proposed decision to grant or deny the Certificate of Public Advantage. The proposed decision of the Department shall be in writing and shall set forth the basis for the decision. The Department shall furnish a copy of the decision to applicants and any affected persons who have asked to be notified. The proposed decision becomes the final agency decision within fifteen (15) days after the receipt of a notice of the proposed decision by the applicant or an affected person who has requested to be notified of the decision, unless a contested case hearing is requested pursuant to *Chapter 5-Appeals* of this regulation. The Department's proposed decision is not final until the completion of the contested case proceedings. The Department shall publish its final decisions in the State Register.

SECTION 308. Project Changes During Review Period:

The Department will review any amendments submitted during the review process and may notify the applicant that the amendments constitute a new application, and that the requirements of Section 301, 302, and 303 of this regulation must be complied with. All applicable times shall be counted as though the amendment were a new application.

SECTION 309. Validity of Certificate of Public Advantage:

The Certificate of Public Advantage, if issued, is only valid for the project described in the application including parties involved, services to be offered, mergers or consolidations approved, or other factors as set forth in the application, except as it may be modified in accordance with these regulations. Implementation of a project or undertaking a project that is not in accordance with the Certificate of Public Advantage application or conditions subsequently agreed to by the applicant and the Department may be grounds for revocation of the Certificate of Public Advantage.

SECTION 310. Proprietary Information:

Information obtained by the Department from the parties requesting a Certificate of Public Advantage shall be available to the public in accordance with the Freedom of Information Act unless the Department determines that the information is protected from disclosure. The Department will make this determination if an applicant submits the information sought to be protected separately, clearly marked as "Confidential", and submits justification that the information is entitled to protection from disclosure under one or more of the grounds therefore in the Freedom of Information Act. Such grounds include but are not limited to:

- 1) Trade secrets including feasibility planning, marketing studies, and evaluations and other materials which contain references to potential customers, competitive information, or evaluations;
- 2) Information of a personal nature where the public disclosure thereof would constitute unreasonable invasion of personal privacy;
- 3) Documents of and documents incidental to proposed contractual arrangements and documents of and documents incidental to proposed sales or purchases of property; or
- 4) Correspondence or work products or any other material that would violate attorney-client relationships.

SECTION 311. Administrative and Judicial Review:

Upon receipt of the advice of the Attorney General or at the end of the review period outlined in Section 306 of these regulations, the Department shall issue a staff decision approving or denying the application for a Certificate of Public Advantage. The Department's staff decision is final fifteen

days after receipt by the applicant unless an administrative appeal is commenced in accordance with applicable regulations. The applicant or affected party is entitled to administrative and judicial review in accordance with the State's Administrative Procedures Act.

SECTION 312. Conditional Approval

The Department may establish conditions for approval that are reasonably necessary to ensure that the cooperative agreement and the activities engaged under it are consistent with these regulations and its purpose to promote cooperation and limit health care costs; protect against abuse of private economic power; improve access to care; improve efficiencies in the delivery of care, including improving economics of scale in the delivery of services; reduce or eliminate unnecessary duplication of services or technology; and to ensure that the activity is appropriately supervised and regulated. Such conditions shall be stated in the Certificate of Public Advantage and shall be fully enforceable.

CHAPTER 4 CRITERIA FOR REVIEW

SECTION 401. Issuance of a Certificate of Public Advantage:

The Department shall issue a Certificate of Public Advantage for a cooperative agreement if it determines that the applicant has demonstrated that the likely benefits resulting from the agreement outweigh the likely disadvantages from the agreement; and the reduction in competition likely to result from the agreement is reasonably necessary to obtain the benefits likely to result.

SECTION 402. Evaluation of Benefits and Disadvantages:

1. In evaluating the benefits likely to result from the cooperative agreement the Department shall consider, but is not limited to:

- a) enhancement of the quality of health and health related care provided to South Carolina citizens;
- b) preservation of health care providers close to communities traditionally served by those providers;
- c) gains in the cost-efficiency of the services offered by health care providers or purchasers involved;
- d) improvements in the use of health care provider resources and equipment;
- e) avoidance or elimination or reduction of duplication of health care resources;
- f) improvements in access to health care for citizens in the community;
- g) support of the agreement by purchasers and payers in the health service area;
- h) the extent of financial risk-sharing by the parties as a result of the agreement;
- i) the provision or enhancement of health care services to Medicaid, indigent, or charity care patients by the parties to the agreement.

2. In evaluating the disadvantages likely to result from the agreement, the Department shall consider but is not limited to:

- a) the likely adverse impact, if any, on the ability of the health care purchasers to negotiate optimal payment and service arrangements with the health care providers or health provider networks;
- b) the extent of any reduction in competition among health care providers, purchasers, or other persons furnishing goods or services to or in competition with health care providers or purchasers that is likely to result directly or indirectly from the health care cooperative agreement;
- c) the likely adverse impact, if any, on patients in the quality, availability, and price of health care services;
- d) the extent to which the agreement may increase the costs of prices of health care at a hospital or other health care provider which is a party to the agreement;
- e) the extent to which services to Medicaid, indigent, or charity care patients are adversely impacted by the agreement.

SECTION 403. Evaluation of Impact of Reduction of Completion:

In evaluating whether the reduction in competition is necessary to obtain the likely benefits, the Department shall consider, but is not limited to:

- 1) The availability of arrangements that:
 - a) are less restrictive to competition and achieve the same benefits;
 - b) offer a more favorable balance of benefits over disadvantages attributable to a reduction in competition likely to result from the agreement;
- 2) The ease with which health care providers or health care purchasers may obtain contracts with other health plans;
- 3) The difficulty in establishing new competing health plans in the relevant geographic market, including the ability to offer services requiring a certificate of need or purchasing these services from another health care provider or health provider network; and
- 4) The sufficiency of the number or type of providers under contract with the health plan available to meet the needs of plan enrollees.

SECTION 404. Additional Considerations:

The Department may consider other information or factors relevant to the purposes of the Health Care Cooperation Act and this regulation. The information or factors so considered shall be specifically stated in the staff decision. Should the Department consider other information or factors that are not published in these regulations, the Department will notify the applicant as soon as is reasonable practical and will provide them an opportunity to respond.

CHAPTER 5 MONITORING

SECTION 501. Monitoring:

The Department shall actively monitor and regulate agreements approved under this regulation. The Department may request information, conduct inspections, or conduct audits whenever necessary to ensure that the agreements remain in compliance with the conditions of approval and the approved application. The same rules apply to information acquired by the Department through information received, inspections conducted or audits conducted as in Section 310 of these regulations. The Department shall provide the applicant at least ten day notice of a compliance audit. The Department shall afford the applicant at least ten days to respond to any complaint, question or problem identified by the Department.

SECTION 502. Activities Report:

(A) During the time the Certificate of Public Advantage is in effect, a report on the activities pursuant to the cooperative agreement must be filed by the parties to the cooperative agreement with the Department at least every two years. Based on this report the Department shall determine whether the cooperative agreement continues to comply with the terms of the Certificate of Public Advantage.

(B) The report shall contain, but not be limited to the following:

1. a detailed description of the implementation of the approved application, contract or other agreement between parties;
2. a detailed description of any changes, modifications, deviations, amendments, or other differences from the approved application;
3. an assessment of the success or failure of the agreement to accomplish the goals, benefits, or other results expected from the approved application. Provide any supporting documentation on which these conclusions are based; and
4. any additional information the parties feel will assist the Department in order to make the assessment required in this Section.

SECTION 503. Revocation of Certificate of Public Advantage:

The Department may revoke a certificate upon a finding that:

- (A) the parties to the agreement are not complying with its terms or the conditions of approval as stated in the Certificate of Public Advantage, or the agreement is not in substantial compliance with the terms of the application or conditions of approval; or

(B) the likely benefits resulting from the certified agreement no longer outweigh any disadvantages attributable to any potential reduction in competition resulting from the agreement; or

(C) the Department's certification was obtained as a result of intentional material misrepresentation to the Department or as the result of coercion, threats, or intimidation toward any party to the cooperative agreement; or

(D) failure to pay the annual monitoring fee.

SECTION 504. Administrative and Judicial Review:

A decision by the department to revoke a Certificate of Public Advantage is subject to administrative and judicial review in accordance with the State's Administrative Procedures Act.

SECTION 505. Civil or Criminal Enforcement:

Nothing in this regulation limits the authority of the Attorney General to initiate civil enforcement action or criminal prosecution upon the determination that health care providers, health providers networks, or health care purchasers have exceeded the scope of the Certificate of Public Advantage approved by the Department.

SECTION 506. Termination of Agreements:

A party to a cooperative agreement who terminates the agreement shall notify the Department within fifteen days of the termination. If all parties terminate their participation in the cooperative agreement, the Department shall revoke the Certificate of Public Advantage for the agreement.

SECTION 507. Certificate of Need Requirement:

Nothing in this Regulation exempts health care providers or purchasers from compliance with the provisions of the S. C. Certification of Need Program.

SECTION 508. Changes After Receipt of a Certificate of Public Advantage:

If an applicant amends, alters, or otherwise changes the agreement after receipt of a Certificate of Public Advantage, the Department will decide whether or not the amendment is substantial and thereby requires another review. A change in the application will be considered substantial if the Department believes that the change materially changes the reasons for approval, might materially impact the benefits or disadvantages to the community to be served, or will change the service area of the original application. The addition or deletion of a party to the agreement does not necessarily constitute a substantial change unless the Department believes that the above mentioned criteria will occur.

SECTION 509. Fees:

(A) Filing Fee: A non-refundable filing fee shall accompany each application for a Certificate of Public Advantage. The filing fee shall be \$3,000 per party to the cooperative agreement up to a maximum of \$15,000 per application. The filing fee must be received with the application in order for the Department to accept the application and begin processing the application.

(B) Monitoring Fee: An annual monitoring fee shall be assessed to each approved application for which a Certificate of Public Advantage is in effect. The annual monitoring fee shall be \$5,000 for each Certificate which has five or fewer parties and \$7,000 for each Certificate that involves more than five parties. Failure to pay this fee will result in revocation of the Certificate of Public Advantage.

HISTORY: Added by State Register Volume 19, Issue No. 6, eff June 23, 1995. Amended by State Register Volume 34, Issue No. 6, eff June 25, 2010.

Editor's Note

Republished in 2020 to correct a scrivener's error, adding "Section 404" to precede "Additional Considerations".

61-32. Wholesale Bottled Water, Soft Drink, and Ice Manufacturing.

(Statutory Authority: S.C. Code Sections 44-1-140 and 44-1-150)

CONTENTS:

SECTION I. PURPOSE.

SECTION II. SCOPE.

SECTION III. DEFINITIONS.

SECTION IV. ADULTERATED OR MISBRANDED BOTTLED WATER, SOFT DRINKS, OR ICE.

SECTION V. COMPLIANCE PROCEDURES.

SECTION VI. LABELING.

SECTION VII. INSPECTION OF BOTTLED WATER, SOFT DRINK, AND ICE PLANTS AND DISTRIBUTION STATIONS.

SECTION VIII. EXAMINATION OF BOTTLED WATER, SOFT DRINKS, AND ICE.

SECTION IX. BOTTLED WATER, SOFT DRINK, AND ICE PLANTS AND DISTRIBUTION STATIONS.

SECTION X. SUBMISSION OF PLANS.

SECTION XI. RECIPROCITY.

SECTION XII. OUT OF STATE BOTTLED WATER IMPORTS.

SECTION XIII. RECALL.

SECTION XIV. EQUIPMENT AND FACILITIES IN OPERATION PRIOR TO JULY 1, 2020.

SECTION XV. PROCEDURE WHEN INFECTION OR HIGH RISK INFECTION IS SUSPECTED.

SECTION XVI. ENFORCEMENT PROVISIONS.

SECTION XVII. SEVERABILITY CLAUSE.

SECTION I. PURPOSE

This regulation sets forth minimum health standards, procedures, and practices to ensure that wholesale BOTTLED WATER, SOFT DRINKS, and ICE are manufactured in South Carolina in a safe and wholesome manner.

SECTION II. SCOPE

This regulation shall apply to all PERSONS who manufacture or distribute wholesale BOTTLED WATER, SOFT DRINKS, or ICE, sold for human consumption in South Carolina.

SECTION III. DEFINITIONS

A. ADEQUATE - substantial compliance with acceptable health standards, procedures, and practices.

B. ADULTERATED or ADULTERATION - BOTTLED WATER, SOFT DRINKS, or ICE are deemed to be ADULTERATED if the product:

1. Bears or contains any poisonous or deleterious substance in a quantity that may render it injurious to health;
2. Bears or contains any added poisonous or deleterious substance for which no state or federal regulation has established a safe tolerance, or in excess of such tolerance if one has been established;
3. Consists, in whole or in part, of any substance unfit for human consumption;
4. Has been produced, processed, prepared, packaged, or held under unsanitary conditions;
5. Is packaged in a container which is composed, in whole or in part, of any poisonous or deleterious substance which may render the contents injurious to health;
6. Has any substance added thereto, or mixed or packaged therewith, so as to increase its bulk or weight, or reduce its quality or strength, or make it appear better or of greater value than it is; or
7. Is in violation of Section 402 of the Federal Food, Drug, and Cosmetic Act, as amended (21 U.S.C. Section 342).

C. APPROVED - acceptable to the Department based on a determination of conformity with principles, practices, and generally recognized standards that protect public health.

D. APPROVED LABORATORY - a laboratory APPROVED by the Department or certified by the U.S. Environmental Protection Agency (EPA), or certified (accredited) by a third-party organization acceptable to the Department.

E. APPROVED SOURCE - the source of the water used in a plant's operations or a bottled water plant's product water, whether it be from a spring, artesian well, drilled well, public or community

water system, or any other source that has been inspected and the water sampled, analyzed, and found of a safe and sanitary quality with or without treatment, and APPROVED by the Department in accordance with Regulation 61–58, State Primary Drinking Water Regulations.

F. ARTESIAN WATER - BOTTLED WATER from a well tapping a confined aquifer in which the water level stands at some height above the top of the aquifer. ARTESIAN WATER may be collected with the assistance of external force to enhance the natural underground pressure. On request, plants shall demonstrate to the Department that the water level stands at some height above the top of the aquifer.

G. BOTTLED WATER - water that is intended for human consumption and that is sealed in bottles or other CONTAINERS with no added ingredients except that it may optionally contain safe and suitable antimicrobial agents. It does not include those FOOD ingredients that are declared in ingredient labeling as “water,” “carbonated water,” “disinfected water,” “filtered water,” “seltzer water,” “soda water,” “SPARKLING WATER,” and “tonic water.”

H. BOTTLING - filling, capping, packaging, or enclosing in CONTAINERS.

I. BOTTLING PLANT - any establishment involved in the manufacturing or packaging of SOFT DRINKS and/or BOTTLED WATERS.

J. BUSINESS DAY - every official work day of the week excluding weekends and state holidays.

K. BULK WATER - source water collected at an APPROVED site remote from the BOTTLING PLANT and transported to the BOTTLING PLANT for further processing and BOTTLING.

L. CODE OF FEDERAL REGULATION (CFR) - a codification of the general and permanent rules and regulations (administrative LAW) published in the Federal Register by the executive departments and agencies of the federal government of the United States. Citations to the CFR in this regulation refer sequentially to the Title, Part, and Section numbers. For example, the citation 21 CFR 117.10 refers to Title 21, Part 117, Section 117.10.

M. CONTAINER - any material used for the packaging of SOFT DRINKS, BOTTLED WATERS, and ICE, whether of glass, plastic, metal, paper, or any combination thereof.

N. DEMINERALIZED WATER - BOTTLED WATER that is produced by distillation, deionization, reverse osmosis, or other suitable process, that meets the definition of PURIFIED WATER in the United States Pharmacopoeia, and is specified by the U. S. Food and Drug Administration (FDA) in 21 CFR 165.110.

O. DEIONIZED WATER - BOTTLED WATER that has been produced by a process of deionization, that meets the definition of PURIFIED WATER in the United States Pharmacopoeia, and is specified by the FDA in 21 CFR 165.110.

P. DEPARTMENT - the South Carolina Department of Health and Environmental Control and its authorized representatives.

Q. DISTILLED WATER - BOTTLED WATER that has been produced by a process of distillation, meets the definition of PURIFIED WATER in the United States Pharmacopoeia, and is specified by FDA in 21 CFR Section 165.110.

R. DRINKING WATER - water that is intended for human consumption and that is sealed in bottles or other CONTAINERS with no added ingredients, except that it may optionally contain safe and suitable antimicrobial agents.

S. EMPLOYEE - a permit holder, PERSON in charge, PERSON having supervisory or managerial duties, PERSON on the payroll, family member, volunteer, PERSON performing work under a contractual agreement, or any other PERSON working in a BOTTLED WATER, SOFT DRINK, or ICE plant or distribution station.

T. EQUIPMENT - all machinery, utensils, conveyors, CONTAINERS, cases, and other articles used in the manufacturing of BOTTLED WATER, SOFT DRINKS, or ICE.

U. EXCLUSION - prevention of a PERSON from working as an EMPLOYEE in a BOTTLED WATER, SOFT DRINKS, or ICE plant or distribution station, or entering a BOTTLED WATER, SOFT DRINKS, or ICE plant or distribution station as an EMPLOYEE.

V. FDA - United States Food and Drug Administration.

W. FOOD - means FOOD as defined in section 201(f) of the Federal Food, Drug, and Cosmetic Act (“FD&C”) and includes raw materials and ingredients.

X. GROUND WATER - water from a subsurface saturated zone that is under a pressure equal to or greater than atmospheric pressure. GROUND WATER must not be under the direct influence of surface water.

Y. ICE - the product, in any form, obtained as a result of freezing water by mechanical or artificial means.

Z. ICE VENDING MACHINES - any self-service machines that act as stand-alone units and may operate without full-time service personnel. These units are activated by the insertion of money; the ICE is bagged automatically or dispensed in bulk to the customer.

AA. IMMINENT HEALTH HAZARD - a significant threat or danger to health that is considered to exist when there is sufficient evidence to show that a product, practice, circumstance, or event creates a situation requiring immediate correction or cessation of operation to prevent illness or injury based on the number of potential illnesses or injuries, and the nature, severity, and duration of the anticipated illness or injury.

BB. LAW - applicable local, state, and federal statutes, regulations, and ordinances.

CC. MANUFACTURED BOTTLED WATER, SOFT DRINKS, AND/OR ICE PRODUCTS DISTRIBUTION STATION - any place or PREMISES, except RETAILERS, where manufactured BOTTLED WATER, SOFT DRINKS, and ICE products are received, stored, and dispensed to RETAILERS (may also be referred to as “Distribution Station”).

DD. MANUFACTURED BOTTLED WATER, SOFT DRINKS, AND/OR ICE PRODUCTS DISTRIBUTOR - any PERSON, except a RETAILER, who receives, stores, and dispenses manufactured BOTTLED WATER, SOFT DRINKS, and ICE products to RETAILERS (may also be referred to as “Distributor”).

EE. MANUFACTURED BOTTLED WATER, SOFT DRINKS, AND/OR ICE PRODUCTS MANUFACTURER - any PERSON, except a RETAILER, who manufactures, processes, or freezes manufactured BOTTLED WATER, SOFT DRINKS, and ICE products for distribution or sale.

FF. MANUFACTURED BOTTLED WATER, SOFT DRINKS, AND/OR ICE PRODUCTS PLANT - any place or PREMISES, except RETAILERS, where manufactured BOTTLED WATER, SOFT DRINKS, and ICE products are manufactured, processed, or frozen for distribution or sale.

GG. MICROORGANISMS - means yeasts, molds, bacteria, viruses, protozoa, and microscopic parasites and includes species that are PATHOGENS. The term “undesirable MICROORGANISMS” includes those MICROORGANISMS that are PATHOGENS, that subject FOOD to decomposition, that indicate that FOOD is contaminated with filth, or that otherwise may cause FOOD to be ADULTERATED.

HH. MINERAL WATER - BOTTLED WATER containing not less than 250 parts per million (ppm) total dissolved solids (TDS), coming from a source tapped at one or more boreholes or springs, originating from a geologically and physically protected underground water source. MINERAL WATER is distinguished from other types of water by its constant level and relative proportions of minerals and trace elements at the point of emergence from the source, with consideration given to the cycles of natural fluctuations. No minerals may be added to this water.

II. NATURAL WATER - bottled spring, mineral, artesian, or WELL WATER that is derived from an underground formation or water from surface water that only requires minimal processing, is not derived from a municipal system or public water supply, and is unmodified except for limited treatment (e.g., filtration, ozonation, or equivalent disinfection process).

JJ. PACKAGED ICE - ICE products packaged by APPROVED manufacturers and sold through retail outlets.

KK. PATHOGEN - a microorganism of public health significance.

LL. PERMIT - the document issued by the DEPARTMENT that authorizes a PERSON or entity to operate a BOTTLED WATER, SOFT DRINKS, or ICE plant or distribution station.

MM. PERMIT HOLDER - the entity, such as the owner, the owner's agent, or other PERSON, that possesses a valid PERMIT to operate a BOTTLED WATER, SOFT DRINKS, or ICE plant or distribution station and is legally responsible for its operation.

NN. PERSON - an association, a corporation, individual, partnership, other legal entity, government, or governmental subdivision or agency.

OO. PEST - any objectionable animals or insects including, but not limited to, birds, rodents, flies and larvae.

PP. PURIFIED WATER - BOTTLED WATER produced by distillation, deionization, reverse osmosis, or other suitable process, that meets the definition of PURIFIED WATER in the United States Pharmacopoeia, and is specified by the FDA in 21 CFR 165.110.

QQ. PREMISES -

1. The physical facility, its contents, its land, and any adjacent or bordering contiguous land or property under the control of the PERMIT HOLDER; or

2. The physical facility, its contents, and land or property not described in (a) of this definition if the facilities and contents are under the control of the PERMIT HOLDER and may impact the BOTTLED WATER, SOFT DRINKS, or ICE plant or distribution station personnel, facilities, or operations, and the BOTTLED WATER, SOFT DRINKS, or ICE plant or distribution station is only one component of a larger operation, such as a healthcare facility, hotel, motel, school, recreational camp, or prison.

RR. RESTRICTION - limitation of the activities of an EMPLOYEE so that there is no risk of transmitting a disease that is transmissible through BOTTLED WATER, SOFT DRINKS, or ICE or their ingredients and the EMPLOYEE does not work with exposed BOTTLED WATER, SOFT DRINKS, or ICE or their ingredients, clean EQUIPMENT, utensils, linens, or unwrapped single-service or single-use articles.

SS. RETAIL FOOD ESTABLISHMENT - an establishment that sells FOOD products directly to consumers as its primary function. RETAIL FOOD ESTABLISHMENTS include, but are not limited to, grocery stores, convenience stores, roadside stands, farmers markets, and community supported agriculture (CSA) operations. Any business making FOOD (including a farm business) with at least 50.1 percent in direct to individual consumer FOOD sales satisfies the definition of a RETAIL FOOD ESTABLISHMENT and is exempt from the Bioterrorism Act registration regulations under the 2002 Bioterrorism Act (21 CFR 1.225) as a RETAIL FOOD ESTABLISHMENT. The term "consumers" does not include businesses. A RETAIL FOOD ESTABLISHMENT also includes certain farm-operated businesses selling FOOD directly to consumers as their primary function.

TT. RETAILER - any PERSON who sells, serves, or dispenses at retail manufactured BOTTLED WATER, SOFT DRINKS, or ICE products that have been processed in an APPROVED manufactured BOTTLED WATER, SOFT DRINKS, or ICE products plant.

UU. REMODELED - any enlarging, replacing of floors, walls, or ceilings, or changing in any respect the structure at which a SOFT DRINK, BOTTLED WATER, or ICE plant is housed. This does not apply to repainting or refinishing of floors or walls.

VV. REVERSE OSMOSIS WATER - BOTTLED WATER that is produced by a process of reverse osmosis, that meets the definition of "PURIFIED WATER" in the United States Pharmacopoeia, and is specified by the FDA in 21 CFR 165.110.

WW. RISK - the likelihood that an adverse health effect will occur within a population as a result of a hazard in a FOOD.

XX. SANITIZE - to ADEQUATELY treat cleaned surfaces by a DEPARTMENT -accepted process that is effective in destroying vegetative cells of PATHOGENS, and in substantially reducing numbers of other undesirable MICROORGANISMS, but without adversely affecting the product or its safety for the consumer.

YY. SOFT DRINK - any nonalcoholic, flavored carbonated beverage, including but not limited to soda or soda water, fruit flavored drink, nonalcoholic still beverage, and seltzer or club soda.

ZZ. SPARKLING BOTTLED WATER - BOTTLED WATER that, after treatment and possible replacement of carbon dioxide, contains the same amount of carbon dioxide that it had at the

emergence from the source. Manufacturers may add carbonation to previously noncarbonated BOTTLED WATER products and label such water appropriately (e.g. sparkling SPRING WATER).

AAA. SPRING WATER - BOTTLED WATER derived from an underground formation from which water flows naturally to the surface of the earth. SPRING WATER must comply with the FDA standard of identity in 21 CFR 165.110.

BBB. STERILE WATER - BOTTLED WATER that meets the requirements under "Sterility Tests" <71> in the current United States Pharmacopoeia and specified by the FDA in 21 CFR 165.110.

CCC. UNEXPOSED PACKAGED FOOD - packaged FOOD that is not exposed to the environment.

DDD. WELL WATER - BOTTLED WATER from a hole bored, drilled, or otherwise constructed in the ground that taps the water of an aquifer.

Additional definitions related to this regulation are found in 21 CFR 117.3, as amended.

SECTION IV. ADULTERATED OR MISBRANDED BOTTLED WATER, SOFT DRINKS, OR ICE

A. No PERSON within South Carolina, or its jurisdiction, shall produce, provide, sell, offer, or expose for sale or have in possession with intent to sell, any BOTTLED WATER, SOFT DRINKS, or ICE that is ADULTERATED or misbranded. Any BOTTLED WATER, SOFT DRINK, or ICE that may contain any unwholesome substance, or that does not conform to an applicable standard of identity or other requirement specified under Section III for that particular BOTTLED WATER, SOFT DRINK, or ICE product, shall be deemed ADULTERATED and/or misbranded.

B. The DEPARTMENT may place a hold order on any BOTTLED WATER, SOFT DRINKS, or ICE it determines or has reason to believe:

1. originated from an unAPPROVED SOURCE;
2. may be unsafe, unwholesome, ADULTERATED, misbranded, or not honestly presented;
3. is not labeled according to LAW; or
4. is otherwise not in compliance with this regulation.

C. The DEPARTMENT may suspend a PERSON's PERMIT for violating a hold order.

D. The DEPARTMENT may impound, condemn, forbid the sale of, or cause to be removed or destroyed, any FOOD that is determined to be in violation of this regulation, unwholesome, contaminated, ADULTERATED, misbranded, or from an unAPPROVED source.

E. The DEPARTMENT may issue a hold order to a PERMIT HOLDER or to a PERSON who owns or controls the FOOD, as specified above, without prior warning, notice of a hearing, or a hearing on the hold order.

F. The DEPARTMENT may examine BOTTLED WATER, SOFT DRINKS, and ICE as often as necessary to determine freedom from ADULTERATION or misbranding. Under a hold order, BOTTLED WATER, SOFT DRINKS, or ICE shall be suitably stored. No PERSON shall remove or alter a hold order, notice, or tag placed on BOTTLED WATER, SOFT DRINKS, or ICE by the DEPARTMENT. No PERSON shall relabel, repack, reprocess, alter, dispose of, or destroy such BOTTLED WATER, SOFT DRINKS, or ICE, or the CONTAINERS thereof, without permission of the DEPARTMENT, except on order by a court of competent jurisdiction.

G. When BOTTLED WATER, SOFT DRINKS or ICE are found to be ADULTERATED by pesticides, herbicides, or other poisonous substances, the PERSON or entity in possession of the product shall remove the product from the market, disposed of, and sale stopped until analysis provides the product to be free from ADULTERATION.

SECTION V. COMPLIANCE PROCEDURES

A. PERMIT.

1. It shall be unlawful for any PERSON to manufacture or distribute BOTTLED WATER, SOFT DRINKS, and/or ICE products in South Carolina without a valid PERMIT issued by the DEPARTMENT for the specific BOTTLED WATER, SOFT DRINK, or ICE products plant or distribution station. Grocery stores, restaurants, soda fountains, and similar establishments where BOTTLED WATER, SOFT DRINKS, or ICE are served or sold at retail, but not processed, may be exempt from the requirements of this section.

2. Every BOTTLED WATER, SOFT DRINKS, or ICE manufacturer and distributor must obtain and maintain a PERMIT. PERMITS are nontransferable with respect to PERSONs and/or locations.

B. Suspension of PERMIT.

1. The DEPARTMENT may suspend a PERMIT whenever:

- a. it has reason to believe a public health hazard exists;
- b. the PERMIT HOLDER has violated any of the requirements of this regulation;
- c. the PERMIT HOLDER has violated its PERMIT or an order of the DEPARTMENT, including but not limited to a hold order; or
- d. the PERMIT HOLDER has interfered with the DEPARTMENT in the performance of its duties.

A suspension shall remain in effect until the violation has been corrected to the satisfaction of the DEPARTMENT.

2. The DEPARTMENT may without prior warning, notice of a hearing, or hearing suspend a PERMIT to operate a BOTTLED WATER, SOFT DRINK, or ICE plant or distribution station when the DEPARTMENT determines that the operation of the BOTTLED WATER, SOFT DRINK, or ICE plant or distribution station, including but not limited to a willful refusal to permit authorized inspection, constitutes an IMMINENT HEALTH HAZARD. Upon summary PERMIT suspension, all manufacturing and distribution operations shall immediately cease. During the process, the PERMIT shall remain suspended unless the IMMINENT HEALTH HAZARD has been corrected.

3. Any BOTTLED WATER, SOFT DRINK, or ICE manufacturer or distributor whose PERMIT has been suspended may make written application for the reinstatement of the PERMIT.

4. Within seven (7) business days of receiving the written application, the DEPARTMENT shall make inspections and/or collect samples for analysis to determine whether the conditions cited in the notice of suspension no longer exist. If conditions warrant, the DEPARTMENT may reinstate the PERMIT.

C. Revocation of PERMIT.

1. The DEPARTMENT may revoke a PERMIT for repeated violations of any of the requirements of this regulation, the PERMIT, or an order of the DEPARTMENT, or for interference with the DEPARTMENT or its staff in the performance of duties. Notwithstanding any other provisions of this regulation, the PERMIT may be revoked if the DEPARTMENT is threatened with bodily harm or physical interference in the performance of inspectional duties.

2. The DEPARTMENT may deny a new PERMIT based upon past noncompliance, including previous enforcement, suspension, or revocation history.

3. Any PERSON whose PERMIT is revoked shall not be eligible to apply for re-permitting within one (1) year from the date of revocation. Any PERSON whose PERMIT has previously been revoked and who obtains a subsequent PERMIT and violates the provisions of this regulation, resulting in revocation of the PERMIT for a second time, shall not be granted another PERMIT for a period of five (5) years.

SECTION VI. LABELING

All BOTTLED WATER, SOFT DRINK, and ICE products shall be labeled according to the requirements in 21 CFR Part 101, as amended.

SECTION VII. INSPECTION OF BOTTLED WATER, SOFT DRINK, AND ICE PLANTS AND DISTRIBUTION STATIONS

A. Each BOTTLED WATER, SOFT DRINK, or ICE manufacturer and distributor whose products are intended for consumption within South Carolina shall be inspected by the DEPARTMENT prior to the issuance of a PERMIT.

B. Following the issuance of a PERMIT, the DEPARTMENT shall inspect each BOTTLED WATER, SOFT DRINK, or ICE manufacturer and distributor at a frequency determined by the RISK level assigned to the product(s) being manufactured or distributed or as otherwise deemed necessary by the DEPARTMENT to determine compliance with this regulation.

C. A copy of the inspection report will be provided, either electronically or in paper form, to the PERMIT HOLDER, manager, or other duly authorized representative.

D. Every BOTTLED WATER, SOFT DRINK, or ICE manufacturer and distributor shall, upon request of a DEPARTMENT representative, permit DEPARTMENT access to all parts of the establishment or facilities to determine compliance with the provisions of this regulation. A PERMIT HOLDER, manager, or other duly authorized representative shall furnish the DEPARTMENT, upon request and for official use only, a true statement of the actual quantities of BOTTLED WATER, SOFT DRINK, or ICE product purchased and sold, a list of all sources of such BOTTLED WATER, SOFT DRINK, or ICE products, records of inspections, and records of tests.

E. It is unlawful for any PERSON who, in an official capacity, obtains any information under the provisions of this regulation which is entitled to protection as a trade secret to use such information to his own advantage or to reveal it to any unauthorized PERSON.

SECTION VIII. EXAMINATION OF BOTTLED WATER, SOFT DRINKS, AND ICE

A. Chemical, microbiological, or extraneous material testing procedures shall be used, where necessary, to identify sanitation failures or possible contamination. All FOOD that has become ADULTERATED shall be rejected, or if permissible, treated or processed to eliminate the contamination.

B. BOTTLED WATER manufacturers must perform weekly total coliform monitoring on the finished product of each BOTTLED WATER product type and conduct quarterly rinse/swab tests on BOTTLED WATER CONTAINERS (incoming, as well as those immediately from the washer) and closures. This monitoring and testing must be performed in-house or by an APPROVED LABORATORY as stipulated in 21 CFR Section 129.80. For microbiological contaminants (total coliform), each BOTTLED WATER manufacturer must analyze a representative sample from a batch or segment of a continuous production run for each BOTTLED WATER product type produced by the plant.

C. Samples of source water shall be taken and analyzed by the BOTTLED WATER plant as often as necessary, but at a minimum frequency of once each year for chemical contaminants and once every four (4) years for radiological contaminants. Facilities that use a public water system for source water may substitute public water system testing results, or certificates showing full compliance with all provisions of the Environmental Protection Agency's National Primary and Secondary Drinking Water Regulations pertaining to chemical contaminants.

D. For chemical, physical, and radiological contaminants, a representative sample from a batch or segment of continuous production run for each type of finished BOTTLED WATER product produced by a water BOTTLING PLANT shall be analyzed annually to ensure that the product(s) complies with current FDA standards.

SECTION IX. BOTTLED WATER, SOFT DRINK, AND ICE PLANTS AND DISTRIBUTION STATIONS

A. Water supply for BOTTLED WATER, SOFT DRINK, and ICE plants and ICE and water vending.

1. The water supply shall be from an APPROVED public water system as defined in R.61-58, State Primary Drinking Water Regulations.

2. The design, operation, and maintenance of water purification systems used to further treat potable water shall be certified as meeting the specifications of the American National Standard Institute/National Sanitation Foundation (ANSI/NSF). All chemicals and products added to the potable water shall meet ANSI/NSF Standard 60. All materials and products installed that come into contact with the potable water shall meet ANSI/NSF Standard 61. The certifying party shall be accredited by the American National Standards Institute. They shall not be operated beyond their rated capacity and shall be maintained in a clean, sanitary condition at all times. This shall include dispensed water and ICE VENDING MACHINES.

3. Potable running water at a suitable temperature, and under pressure as needed, shall be provided in all areas where required for the processing of SOFT DRINKS, BOTTLED WATER, and ICE; for the cleaning of EQUIPMENT, utensils, and CONTAINERS; and for EMPLOYEE sanitary facilities.

4. Carbonated water shall be conveyed in APPROVED stainless steel or equal FOOD-grade piping and not in piping of galvanized iron, lead, zinc, or other deleterious materials.

5. All water storage and cooling tanks shall be of noncorrosive material, properly covered; air vents properly filtered, clean, and free from dust both inside and outside; and the inlet and outlet so arranged as to prevent contamination during filling and emptying.

B. Required rooms.

1. Except as APPROVED by the DEPARTMENT under paragraph B.2 below, each BOTTLED WATER and SOFT DRINK plant shall have a separate room (commonly called a syrup or blend room) or separate area of the filling room for mixing ingredients for BOTTLED WATER or SOFT DRINKS. This room or separate area of the filling room shall be used only for mixing ingredients and storage of mixed batches.

2. Each BOTTLED WATER and SOFT DRINK plant shall have a separate room for filling and sealing CONTAINERS (commonly called a filling or BOTTLING room). This room shall contain only necessary filling, sealing, electronic inspection, coding, and labeling EQUIPMENT. Only the exit end of the bottle washing machine shall open into this room through a tight-fitting wall. If APPROVED by the DEPARTMENT, the mixing of ingredients and storage of mixed batches may be conducted in this room.

3. ICE for human consumption shall be processed and packaged only in rooms used exclusively for processing and packaging ICE for human consumption. ICE for human consumption shall not be processed or packaged on open platforms or on trucks or delivery vehicles, or in any manner which would allow contamination from overhead drip, condensation, dirt, or other contaminants.

C. Transportation of BULK WATER for BOTTLED WATER plants.

1. BULK WATER shall be from a public water system as APPROVED and defined in R.61-58 by the DEPARTMENT.

2. The means and methods of transporting BULK WATER shall be APPROVED by the DEPARTMENT. Bulk tanks, hoses, pumps, and connections used for loading, transporting, and unloading water shall be SANITIZED. Source water for transport shall be treated with an effective disinfectant APPROVED by the DEPARTMENT at an APPROVED concentration prior to being transported.

3. Tank filling and delivery hose connections shall be cleaned and SANITIZED on a regular basis. The tank shall be sealed at all times except when being filled, being cleaned and SANITIZED, and when the water is being unloaded. A record of such cleaning and SANITIZING shall be maintained with the vehicle and shall be available upon request by the DEPARTMENT. Pumps, hoses, connections, and fittings shall be capped and protected from contamination when not in use. The tank manhole shall not be used as a means of filling the tank. To prevent collapse of the tank during delivery of BULK WATER, the manhole may be opened but shall be provided with an air filter to prevent contamination.

4. All surfaces which come into contact with water during storage prior to transport shall be of smooth, impervious, nonabsorbent, corrosion resistant, and nontoxic material such as stainless steel of the American Iron and Steel Institute 300 Series, or equally corrosion resistant, nontoxic material. All water contact surfaces shall be free of substances that may render the water hazardous to health or may adversely affect the flavor, color, turbidity, odor, radiological, microbiological, or chemical quality of the water.

5. BULK WATER transport is intended to move source water from one area to another for the purpose of treatment, packaging, and human consumption. Such water shall not be dispensed directly to consumers from a BULK WATER transport tank or indirectly through some other vending device, unless otherwise APPROVED by the DEPARTMENT. In case of an emergency, such as a DRINKING WATER shortage or outage, or a contaminated water supply, treated water may be dispensed directly from a properly SANITIZED water transport tank.

D. Returnable CONTAINER cleaning.

1. All returnable CONTAINERS shall be ADEQUATELY, mechanically washed and SANITIZED prior to filling. Unless the CONTAINERS are sealed after washing, they shall be washed immediately

prior to filling. Hand cleaning of CONTAINERS is prohibited except as a preliminary to subsequent mechanical washing.

2. Metal and glass CONTAINERS.

(a) All metal and glass CONTAINERS shall be exposed to a minimum three percent (3%) alkali solution of which not less than sixty percent (60%) is caustic soda (sodium hydroxide) by an APPROVED automatic mechanical method for a period of not less than five (5) minutes at a temperature of not less than 130°F, or to an equivalent cleaning and sanitizing process APPROVED by the DEPARTMENT.

(b) CONTAINERS shall be rinsed of all caustic soda with potable water.

3. Polycarbonate CONTAINERS.

(a) Polycarbonate CONTAINERS shall be cleaned with APPROVED non-caustic detergents at their required concentrations by an APPROVED mechanical method.

(b) An APPROVED sanitizing rinse consisting of chlorine, bromine, iodine, quaternary ammonia, or ozonated water at the proper APPROVED temperature/time/concentration must follow the cleaning cycle.

4. A permanent record of key operating parameters of the CONTAINER washer should be maintained. These records or logs should include, but are not limited to, wash temperatures, concentrations of cleaners, concentrations of SANITIZERS, lack of carryover of cleaners or caustic in bottles, and maintenance on the washer. Tests on cleaner/SANITIZER concentrations and carryover should be carried out at start-up and regularly thereafter throughout the shift. All maintenance on the washer should be recorded, such as cleaning or aligning spray jets. All records shall be kept on file at least two (2) years for regulatory inspection. Each washer shall be equipped with an indicating thermometer.

E. Single-service CONTAINERS.

1. Single-service CONTAINERS shall be manufactured from FOOD-grade materials that do not impart odors or tastes to the product, nor contaminate the product with MICROORGANISMS, or toxic or injurious substances.

2. Single-service CONTAINERS shall be packaged and stored in a manner APPROVED by the DEPARTMENT prior to filling.

3. Unless otherwise APPROVED by the DEPARTMENT, all single-service CONTAINERS shall be inverted and rinsed with potable water, then treated by filtered compressed air or vacuumed to remove dust prior to filling.

F. Inspection of returnable CONTAINERS.

1. Bottles.

(a) All empty bottles shall be visually inspected immediately after the final rinse of the washing operation for defects, chips, foreign objects, and unclean product contact surfaces as the bottles pass on a conveyor before a well-illuminated background at a speed slow enough for the inspector to achieve high efficiency.

(b) Dirty bottles shall be removed from the production line and either destroyed or rewashed. Defective bottles shall be removed from the production line and destroyed. When inspectors break bottles for cullet, ADEQUATE protection shall be provided for exposed bottles in the immediate area to prevent glass fragments from entering them.

(c) Electronic inspection devices can be used in addition to visual inspection; however, electronic inspection devices shall not be substituted for visual inspection of returnable bottles without the approval of the DEPARTMENT. Inspectors shall have good eyesight, with or without corrective lenses, and shall be rotated to non-inspection work as often as is necessary to maintain high efficiency.

(d) Returnable bottles shall not be used where their condition or design may prevent proper inspection of the contents thereof.

2. Metal canisters.

(a) All metal canisters shall be visually inspected immediately after the final rinse of the washing operation for the presence of foreign objects or unclean product contact surfaces.

(b) Unclean canisters shall be either immediately returned to the washer or removed to the storage area for unclean canisters.

G. CONTAINER closures.

1. CONTAINER closures shall be manufactured from FOOD-grade materials which do not impart odors or tastes to the product, nor contaminate the product with MICROORGANISMS, or toxic or injurious substances.

2. CONTAINER closures shall be received by the BOTTLING PLANT in an undamaged package sealed by the manufacturer.

3. All CONTAINER closures shall be stored in a clean, dry place protected from insects, rodents, dust, splash, or other contamination. Closures which have been touched on the inner side by the operator, as may occur while adjusting EQUIPMENT, shall be discarded.

4. CONTAINER closures not used during the period of processing operations shall be resealed in their original CONTAINER or stored in an APPROVED tightly covered CONTAINER.

5. Only new CONTAINER closures shall be used.

H. Filling and sealing.

1. CONTAINERS shall be filled and sealed with APPROVED mechanical EQUIPMENT. Manual filling and sealing shall be prohibited, except when otherwise APPROVED by the DEPARTMENT for package sizes in which mechanical sealing EQUIPMENT is not yet readily available.

2. Filling EQUIPMENT which fills glass CONTAINERS under pressure should be provided with an ADEQUATE shield to protect against broken glass entering unsealed CONTAINERS. Whenever a glass bottle breaks while being filled or sealed, the machinery involved shall be stopped and all broken glass shall be removed from parts that touch the opening of bottles or contact the product. This shall be performed in such a manner to protect against transferring broken glass into nearby bottles that have exposed openings.

3. No PERSON or his clothing shall come in contact with any portion of the CONTAINER or EQUIPMENT that might result in contamination of the product.

4. The contents of all imperfectly sealed CONTAINERS shall be discarded.

I. SANITATION OF BOTTLED WATER, SOFT DRINK, AND ICE PLANTS AND DISTRIBUTION STATIONS

1. All BOTTLED WATER, SOFT DRINK, and ICE manufacturers and distributors, regardless of exemption status, shall comply with the requirements of 21 CFR Part 117, Subpart A - General Provisions, Subpart B - Current Good Manufacturing Practice, and Subpart F - Requirements Applying to Records That Must Be Established and Maintained, as amended.

2. All BOTTLED WATER, SOFT DRINK, and ICE plants and distribution stations that have been granted a Qualified Facility Exemption by the FDA or that are solely engaged in the storage of refrigerated UNEXPOSED PACKAGED FOODS when temperature controls are necessary to prevent PATHOGEN growth shall comply with the requirements of 21 CFR Part 117, Subpart A - General Provisions, Subpart B - Current Good Manufacturing Practice, Subpart D - Modified Requirements, and Subpart F - Requirements Applying to Records That Must Be Established and Maintained, and be familiar with Subpart E - Withdrawal of a Qualified Facility Exemption, as amended.

3. All BOTTLED WATER, SOFT DRINK, and ICE plants and distribution stations that have not been granted a Qualified Facility Exemption by the FDA shall comply with the requirements of 21 CFR Part 117, Subpart A - General Provisions, Subpart B - Current Good Manufacturing Practice, Subpart C - Hazard Analysis and Risk -Based Preventive Controls, and Subpart F- Requirements Applying to Records That Must Be Established and Maintained, as amended.

4. All BOTTLED WATER, SOFT DRINK, and ICE plants and distribution stations under an FDA order to withdraw their Qualified Facility Exemption are subject to the requirements of 21 CFR Part 117, Subpart E - Withdrawal of a Qualified Facility Exemption, as amended.

5. BOTTLED WATER, SOFT DRINK, and ICE plants and distribution stations that have not been granted a Qualified Facility Exemption by the FDA and have identified a hazard requiring a

supply-chain applied control shall comply with the requirements of 21 CFR Part 117, Subpart G - Supply-Chain Program, as amended.

SECTION X. SUBMISSION OF PLANS

Before a SOFT DRINK, BOTTLED WATER, or ICE plant is constructed or extensively REMODELED, or when an existing structure is converted for use as a SOFT DRINK, BOTTLED WATER, or ICE plant, the BOTTLED WATER, SOFT DRINK, or ICE manufacturer must submit properly prepared plans and specifications for such construction, remodeling, or conversion to the DEPARTMENT for review and approval before construction, remodeling, or conversion. The plans and specifications shall indicate the proposed layout, arrangement, mechanical plans, and construction materials of work areas, and the make and model number of proposed fixed EQUIPMENT and facilities.

SECTION XI. RECIPROCITY

A. BOTTLED WATER, SOFT DRINKS, and ICE from out of state or outside the United States may be sold in South Carolina only if the DEPARTMENT determines they are manufactured and distributed under provisions substantially equivalent to the requirements of this regulation and ADEQUATELY enforced.

B. Upon receiving from any PERSON, entity, or any regulatory agency outside this state a report of a possible violation of this regulation by a PERMIT HOLDER, the DEPARTMENT may conduct such inspection or investigation as it deems appropriate. Upon receiving information that SOFT DRINKS, BOTTLED WATER, or ICE manufactured outside this state and introduced into this state may have been manufactured in violation of applicable state or federal LAW, or not in conformance with prevailing and applicable standards and good public health practices, the DEPARTMENT may notify appropriate regulatory authorities located outside this state and request that such authorities take appropriate action.

SECTION XII. OUT-OF-STATE BOTTLED WATER IMPORTS

Due to additional FDA laboratory testing requirements for BOTTLED WATER products, out-of-state water bottlers shall submit the following to the DEPARTMENT: (a) a certification signed by the applicable regulatory agency with jurisdiction over the BOTTLING in the state of origin stating that the plant(s) is permitted or licensed as required, the source water supply meets all EPA public DRINKING WATER requirements, and is operated and maintained in a sanitary manner based on previous plant inspection(s); (b) the name, address, and phone number(s) of all plant(s) manufacturing bottled products for sale in South Carolina; (c) a copy of the latest finished BOTTLED WATER product water analyses (total coliform, inorganic, organic, radiological); and (d) the location(s) where the product(s) may be sampled in South Carolina.

SECTION XIII. RECALL

A. For BOTTLED WATER, SOFT DRINK, and ICE manufacturers and distributors that have not been granted a Qualified Facility Exemption by the FDA, the Recall Plan requirements of 21 CFR 117.139 supersede the requirements of this section.

B. Each SOFT DRINK, BOTTLED WATER, and ICE manufacturer and distributor shall develop and maintain procedures for the notification of regulatory officials, consumer notification, and product recall, and shall implement any said procedure as necessary with respect to any product for which the PERMIT HOLDER or the DEPARTMENT has reason to believe circumstances exist that may adversely affect its safety for the consumer. If the DEPARTMENT determines, based upon representative samples, RISK analysis, information provided by the SOFT DRINK, BOTTLED WATER, or ICE manufacturer or distributor, and/or other information available to the DEPARTMENT, that the circumstances present an IMMINENT HEALTH HAZARD and that a form of consumer notice or product recall can effectively avoid or significantly minimize the threat to public health, the DEPARTMENT may order the SOFT DRINK, BOTTLED WATER, or ICE manufacturer and/or distributor to initiate a level of product recall or, if appropriate, issue a form of notification to customers. Each SOFT DRINK, BOTTLED WATER, and ICE manufacturer and distributor shall be responsible for disseminating the notice in a manner designed to inform customers who may be affected by the problem.

SECTION XIV. EQUIPMENT AND FACILITIES IN OPERATION PRIOR TO JULY 1, 2020

A. EQUIPMENT and physical facilities of BOTTLED WATER, SOFT DRINK, and ICE plants and distribution stations in operation prior to July 1, 2020 are deemed in compliance even if they do not

meet all construction, EQUIPMENT, and facilities requirements of this regulation if the facilities and EQUIPMENT:

1. are in compliance with the regulatory standards in place for such EQUIPMENT and facilities on January 1, 2020; and
2. are capable of being maintained in a sanitary condition; and
3. are not a public health hazard or nuisance; and
4. are replaced in the normal course of operation with EQUIPMENT and facilities that meet the requirements of this regulation.

B. This section shall not apply to EQUIPMENT installed or construction commenced on or after July 1, 2020.

SECTION XV. PROCEDURE WHEN INFECTION OR HIGH RISK INFECTION IS SUSPECTED

When reasonable cause exists to suspect the possibility of transmission of infection from any PERSON concerned with the handling of BOTTLED WATER, SOFT DRINKS, or ICE products, or their ingredients, the DEPARTMENT is authorized to require any or all of the following measures:

- A. The immediate EXCLUSION or RESTRICTION of that PERSON from handling BOTTLED WATER, SOFT DRINKS, and ICE products, or their ingredients;
- B. The immediate removal of the BOTTLED WATER, SOFT DRINKS, and ICE products concerned from distribution and use; and/or
- C. ADEQUATE medical and bacteriological examination of the PERSON, of their associates, and of their bodily discharges.

SECTION XVI. ENFORCEMENT PROVISIONS

This regulation is issued under the authority of S.C. Code Ann. Sections 44–1–140 and 44–1–150 and shall be enforced by the DEPARTMENT. Any PERSON found to be in violation of this regulation, in non-compliance with an issued PERMIT, or in violation of an order issued by the DEPARTMENT shall be subject to civil monetary penalties, PERMIT suspension, and/or PERMIT revocation. Each day of continued violation shall be a separate offense.

SECTION XVII. SEVERABILITY CLAUSE

Should any section, paragraph, sentence, clause or phrase of this regulation be declared unconstitutional or invalid for any reason, the remainder of said regulations shall not be affected thereby.

HISTORY: Amended by State Register Volume 16, Issue No. 6, eff June 26, 1992; State Register Volume 28, Issue No. 5, eff May 28, 2004; SCSR 44–6 Doc. No. 4903, eff June 26, 2020.

61–33. Drycleaning Facility Restoration Trust Fund.

(Statutory Authority: 1976 Code Section 44–56–410, et seq.)

Table of Contents

33.1. Purpose and Applicability.

33.2. Definitions.

33.3. Severability.

SUBPART A. Eligibility Applications.

33.4. General Provisions.

33.5. Due Diligence.

SUBPART B. Moratorium for Eligible Sites.

33.6. Moratorium for Eligible Sites.

SUBPART C. Financial Responsibility.

33.7. General Provisions.

33.8. Transfer of Ownership.

- 33.9. Excluded Costs.
- 33.10. Remitting Payments To The Fund.
- 33.11. Costs Incurred for Emergency Actions.

SUBPART D. Facility Prioritization.

- 33.12 General Provisions.
- 33.13. Immediate Removal Actions.
- 33.14. Emergency Sites.
- 33.15. Restoration Priority List.

SUBPART E. Restoration.

- 33.16. General Provisions.
- 33.17. Detailed Facility Investigation.
- 33.18. Restoration Goals and Evaluation.
- 33.19. Restoration Implementation.

33.1. Purpose and Applicability.

(A) This regulation contains procedures to implement the Drycleaning Facility Restoration Trust Fund Act and establishes the criteria for determining priority for rehabilitation of Drycleaning Facilities contaminated with Drycleaning Solvents using funds provided under this Act.

(B) Applicability:

(1) This regulation applies to dry cleaners, Persons and wholesalers that have registered with the Department of Revenue where:

(i) The owner or operator of a Site uses or has used Drycleaning Solvents for the purpose of cleaning clothing and other fabrics; or,

(ii) The Person owns, has dominion, has legal or rightful title, or has a ground lease interest in the real property where a Drycleaning Facility or Wholesale Supply Facility is or has been located; or,

(iii) The wholesaler stores or has stored Drycleaning Solvent for wholesale distribution to Drycleaning establishments.

(2) This regulation does not apply to any dry cleaner that has chosen not to participate in the Drycleaning Facility Restoration Trust Fund as specified in the Drycleaning Facility Restoration Trust Fund Act.

(3) This regulation does not apply to any dry cleaner owned by a government entity as specified in the definition of Drycleaning Facility.

(4) This regulation does not apply to textile mills, linen supply, or uniform rental facilities unless operated as a commercial Drycleaning Facility prior to July 1, 1995 as specified in Section 44-56-410(3).

(5) This regulation does not apply to Releases that occur after November 18, 1980 that are the result of gross negligence.

33.2. Definitions.

For the purpose of these regulations, the following definitions will apply.

(A) "Act" means Article 4 of the S.C. Hazardous Waste Management Act, Section 44-56-400 et seq. of the Code of Laws of 1976 as amended, known as the Drycleaning Facility Restoration Trust Fund.

(B) "Board" means the Board of the South Carolina Department of Health and Environmental Control.

(C) "Deductible" means the monies specified in the Act that the Responsible Applicant is responsible for paying.

(D) "Department" means the Department of Health and Environmental Control, including personnel thereof authorized by the Board to act on behalf of the Department or Board.

(E) “Drycleaning Facility” means a professional commercial establishment located in this State for the purpose of cleaning clothing and other fabrics utilizing a process that involves the use of drycleaning solvent. In the case of a retail establishment, the establishment is one that operates or has at some time in the past operated in whole or in part for the purpose of cleaning clothing and other fabrics for members of the public, other drycleaning facilities, and dry drop-off facilities. In the case of a wholesale establishment, the establishment is one that operates or has at some time in the past operated in whole or in part for the purpose of cleaning clothing and other fabrics for other drycleaning facilities or dry drop-off facilities. “Drycleaning facility” includes laundry facilities that are using or have used drycleaning solvent as part of their cleaning process but does not include textile mills, uniform rental and linen supply facilities, or drycleaning facilities owned or operated by a local, state, or federal government.

(F) “Drycleaning Solvents” means nonaqueous solvents used in the cleaning of clothing and other fabrics and includes halogenated drycleaning fluids and nonhalogenated drycleaning fluids, and their breakdown products. “Drycleaning Solvent” includes solvent that has been recycled for use at a drycleaning facility and applies only to those solvents used at a drycleaning facility or handled by a wholesale supply facility.

(G) “Emergency Site” means a site that is contaminated with Drycleaning Solvents at concentrations above an action level or the appropriate risk-based standard set by the Department:

- (1) In a public or private drinking water well; or,
- (2) At off-site areas with high potential for human exposure.

(H) “Existing Drycleaning Facility” means a Drycleaning Facility that started operation before November 24, 2004.

(I) “Former Drycleaning Facility” means a Drycleaning Facility that ceased to be operated as a Drycleaning Facility before July 1, 1995.

(J) “Fund” means the Drycleaning Facility Restoration Trust Fund.

(K) “Gross Negligence” means any action where normal reasonable precautions, including but not limited to the requirements of Section 44–56–480 of the Act, and including those in general widespread industrial practice, have been avoided, neglected, or deliberately omitted.

(L) “Ineligible” means a Drycleaning Facility or contaminated Site that has been permanently barred from receiving monies from the Fund and to which the moratorium does not apply pursuant to the Act.

(M) “New Drycleaning Facility” means a Drycleaning Facility that started operation on or after November 24, 2004.

(N) “Nonhalogenated Drycleaning Fluid” means any nonaqueous solvent used in a drycleaning facility that contains less than ten percent by volume of any halogenated drycleaning fluid. Nonhalogenated Drycleaning Fluid includes petroleum-based Drycleaning Solvents and their breakdown components.

(O) “Person” means an individual, partnership, corporation, association, trust, estate, receiver, company, limited liability company, or another entity or group.

(P) “Registrant” means a dry cleaner or Person who has registered with the Department of Revenue pursuant to the Act.

(Q) “Release” means the accidental or intentional spilling, leaking, pumping, pouring, emitting, emptying, discharging, injecting, escaping, leaching, dumping, or disposing into the environment of a Drycleaning Solvent.

(R) “Responsible Applicant” is defined as follows:

- (1) For an existing Drycleaning Facility, the current registrant identified to the Department of Revenue on the yearly registrations forms.
- (2) For an existing Drycleaning Facility that ceases to operate as such, the most recent registrant identified to the Department of Revenue at the time the operation was discontinued.
- (3) For a former Drycleaning Facility, the registrant which most recently owned or operated the Drycleaning Facility.

(4) For a Drycleaning Facility that was owned by one registrant and concurrently operated by a different registrant and both are eligible for the Fund, the registrant who operated the facility.

(S) "Site" means the area where a Drycleaning Facility or Wholesale Supply Facility is or has been located and where drycleaning fluids have been deposited, stored, disposed of, or placed, or otherwise come to be located.

(T) "Wholesale Supply Facility" means a commercial establishment that supplies Drycleaning Solvents to Drycleaning Facilities.

33.3. Severability.

Should any section, paragraph, sentence, clause or phrase of this regulation be declared unconstitutional or invalid for any reason, the remainder of this regulation shall not be affected thereby.

SUBPART A

Eligibility Applications

33.4. General Provisions.

(A) In order for a Drycleaning Facility or Wholesale Supply Facility to be considered for Fund eligibility, the Responsible Applicant shall submit an application package on forms provided by the Department and consisting of:

- (1) A signed application form;
- (2) The findings of due diligence as defined in subsection 33.5 if this is the first application package completed by a registrant; and,
- (3) A signed containment certification form.

Forms can be obtained from the DHEC website or by mail from: DHEC - Bureau of Land and Waste Management, Attn.: Drycleaning Facility Restoration Trust Fund Program, 2600 Bull Street, Columbia, SC, 29201.

(B) The Responsible Applicant is responsible for compliance with these regulations.

(C) The Responsible Applicant shall submit a separate application package for each Drycleaning Facility where an eligibility determination is desired. Deadlines for submittal of an application package are as specified in Section 44-56-470(D). If the Department declares a Drycleaning Facility or Wholesale Supply Facility an emergency or an immediate removal site as detailed in subsections 33.14 and 33.13, the Responsible Applicant shall submit the application package for a determination of eligibility not later than forty-five days after the Department's declaration, if the package had not been submitted previously.

(D) The Department will notify the Responsible Applicant within ninety days after receipt and review of an application package. This notification will include a statement that the application package is either complete or incomplete.

(1) The submittal date of the application package shall be the date of its receipt by the Department.

(2) If the application package is incomplete, the Responsible Applicant shall be allowed up to forty-five days from the Department's request for further information. Failure to provide the information as requested shall render the application package null and void. A new application package may be submitted.

(E) Within one hundred and eighty days after initial receipt of a complete application package, the Department will notify the Responsible Applicant as to whether the Site is eligible or ineligible for the Fund. Eligibility for the Fund is contingent on:

(1) The Responsible Applicant submitting an application by the deadlines specified in Section 44-56-470 (D); and,

(2) The Responsible Applicant meeting all criteria set forth in all sections of the Act.

(F) The Department will prioritize all Sites based upon Subpart D of this regulation for which an application package has been submitted.

33.5. Due Diligence.

(A) The Responsible Applicant shall exercise due diligence to identify any and all former Drycleaning Facilities for which the Responsible Applicant was the owner, operator, Person or otherwise potentially financially liable. This identification shall extend backwards in time until either the existence of a Former Drycleaning Facility is discovered or the history of the property reasonably indicates that it could not have been used as a Former Drycleaning Facility. This due diligence shall include the following:

(1) A review of all property currently or previously owned by the applicant to determine if a Former Drycleaning Facility operated on the property prior to, or concurrent with, the Responsible Applicant ownership of the property.

(2) A review of any property previously owned by any Responsible Applicant's acquired subsidiary business to determine if a Drycleaning Facility operated on the property at any time prior to, or concurrent with, the Responsible Applicant's ownership interest of the property; and,

(3) A review of any business location currently or formerly operated by the Responsible Applicant or the Responsible Applicant's acquired subsidiary business on leased property to determine if a Former Drycleaning Facility was at any time operated by the Responsible Applicant or his acquired subsidiary business.

(B) A narrative summary including supporting documentation of all property location reviews shall be submitted with the first eligibility application.

(C) The Responsible Applicant shall have a continuing obligation to disclose the location of Former Drycleaning Facilities for which the applicant is liable. The Responsible Applicant shall submit application packages in compliance with the Act and include an addendum to the narrative summary described in subsection 33.5(B):

(1) Within ninety days of the Responsible Applicant discovering a Former Drycleaning Facility not previously identified in the narrative summary. This addendum shall include information on the newly-identified Former Drycleaning Facility and a detailed explanation of why the site was not discovered using due diligence. If the Department subsequently determines that the Former Drycleaning Facility should have been discovered using a reasonable application of due diligence, the Former Drycleaning Facility shall not be eligible for the Fund or the moratorium.

(2) Within one hundred and eighty days after the Responsible Applicant acquires new commercial property either through direct acquisition or through a new ownership interest in an acquired subsidiary business that included a Former Drycleaning Facility. Any properties not identified within one hundred and eighty days will not be eligible for the Fund.

(D) Any costs incurred by the Responsible Applicant to identify Former Drycleaning Facilities shall not be credited toward the Responsible Applicant deductible nor be eligible for reimbursement from the Fund.

SUBPART B

Moratorium for Eligible Sites

33.6. Moratorium for Eligible Sites.

In order to qualify for the moratorium on judicial or administrative actions by the Department:

(A) The Site must be determined by the Department to be eligible for the Fund under Subpart A.

(B) The dry cleaner or Person shall comply with the Act and all regulations promulgated by the Department for the proper control, management, or disposal of Drycleaning Solvents and wastes containing Drycleaning Solvents, including any regulations to restrict Releases to the atmosphere.

(C) The Releases of Drycleaning Solvent must not be the result of gross negligence after November 18, 1980.

SUBPART C

Financial Responsibility

33.7. General Provisions.

(A) The Responsible Applicant shall submit the application for eligibility and pay any deductibles as set forth in subsection 33.10 and shall be current with payment of all surcharges and fees.

(B) The Department will only negotiate with the Responsible Applicant or his/her designee.

(C) Nothing in this subsection shall preclude the Responsible Applicant from entering into contractual arrangements with any other owners/operators or Persons to obtain a share, if any, of the cost of the assessments or the deductibles from the Fund.

(D) Designation of the Responsible Applicant shall not preclude the Department from seeking judicial or administrative actions against any and all responsible parties in the event that the Site is no longer eligible for the Fund or the moratorium.

33.8. Transfer of Ownership.

(A) The seller shall notify the Department within fifteen days after ownership of any Drycleaning Facility is conveyed to a different Person or after the responsibilities under this regulation for any Former Drycleaning Facility are conveyed to a different Person.

(1) The seller shall submit this notification in writing.

(2) This notification shall include the identity of the purchaser along with a mailing address and telephone number.

(B) Once a Site is determined to be eligible for the Fund, subsequent conveyance of the ownership of the Drycleaning Facility shall not restrict the eligibility of the Site for the Fund or the moratorium.

(C) The new owner of the Drycleaning Facility shall be financially responsible for any remaining portion of the previous owner's deductible as specified in subsection 33.10.

(D) The new owner of the Drycleaning Facility shall be financially responsible for all surcharges and fees.

(E) Once a Drycleaning Facility or Wholesale Supply Facility has been determined by the Department to be ineligible for the Fund, that facility shall not become eligible for the Fund even if ownership is transferred to a different Person.

33.9. Excluded Costs.

(A) Excluded costs incurred by the Responsible Applicant shall not be accredited towards the Responsible Applicant deductible or be considered for reimbursement from the Fund.

(B) Excluded costs include but are not limited to:

(1) Compensation for any time expended by the Responsible Applicant or his employees to conduct due diligence, locate potential Release points of Drycleaning Solvents, or complete any required information or application forms.

(2) Fees paid to attorneys, accountants, or other auxiliary personnel which may be incurred as a result of negotiating with the Department.

(3) Any real or perceived loss of revenue resulting from any activities performed under these regulations.

33.10. Remitting Payments to the Fund.

(A) After the Department spends Fund money on a site, the Responsible Applicant shall pay into the Fund any unspent balance of his/her deductible up to the amount spent by the Department.

(B) The Responsible Applicant shall remit the full balance of the expended funds or shall enter into a payment plan with the Department within thirty days after notification by the Department that the funds have been used.

(C) If the Responsible Applicant chooses to enter into a payment plan, the Responsible Applicant shall make payments to the Fund on a quarterly basis.

(1) No interest shall be assessed for any outstanding balance paid in full within one year after notification by the Department.

(2) For payments extending beyond one year, interest shall be collected as a fixed-rate, simple interest on the remaining balance spent by the Department.

(3) The Department will set the annual interest rate at one and one-half times greater than the Federal Prime Interest rate in effect on the first day of July of that year. All payment plans entered into during the fiscal year July 1 through June 30 shall be set at that that rate.

33.11. Costs Incurred for Emergency Actions.

If the Department uses Fund money on an emergency site pursuant to subsection 33.14.(B) and an eligibility application is not submitted as specified in subsection 33.4, the Department shall recover to the fund the total amount expended, plus interest, from any Person responsible to the Fund for the contamination.

SUBPART D

Facility Prioritization

33.12. General Provisions.

(A) All sites will be prioritized after an application package has been received using the prioritization system described in subsection 33.15 to determine the appropriate order by which Fund monies will be expended for the most efficient reduction of risk.

(B) Publication of the prioritization list.

(1) The prioritization list will be published on an annual basis thereafter on the Department's web site.

(2) This list will be revised as sites are re-scored or added to the list.

(C) The Department will determine whether a Site is an Emergency Site or a candidate for an immediate removal action based on information obtained from any source.

(D) The Department may expend Fund monies to reduce the threat to human health for an Emergency Site before an eligibility assessment has been submitted.

(E) Once the concerns of the Emergency Site or the immediate removal site have been addressed, additional restoration will proceed at the Site based on its priority determined through use of the prioritization system.

(F) The Department may reprioritize a Site at any time to reflect new information gained on the Site.

33.13. Immediate Removal Actions.

(A) The Department may require an immediate removal action at a Site if the Department determines that:

(1) Waste containing a substantial concentration of Drycleaning Solvent that has not entered into the environment is present at the Site; and,

(2) Early removal of the waste will effectively reduce the long-term cost of restoring the Site; and,

(3) The waste can easily be removed from the Site through conventional methods of segregation, excavation, and/or pumping from containers.

(B) The Responsible Applicant shall remove the waste from the Site within 45 days after notification by the Department.

(1) The removed waste must be managed in accordance with the South Carolina Hazardous Waste Management Regulations, R.61-79 as amended.

(2) Any costs incurred by the Responsible Applicant for removal of the waste shall not be accredited towards his/her deductible or reimbursed from the Fund.

(3) Failure to remove the waste properly after due notice shall constitute gross negligence under this regulation.

(C) Immediate removal actions will not include any extraction techniques to reduce the contaminant concentrations in soil or water.

33.14. Emergency Sites.

(A) The Department will declare a Site to be an Emergency Site if:

(1) Any currently used drinking water is contaminated with Drycleaning Solvents or their breakdown products at concentrations greater than the appropriate risk based criteria and/or established standards; or,

(2) Drycleaning Solvents, or their breakdown products, are found in surface soils at concentrations greater than the appropriate risk based criteria and/or established standards for short term exposure and the Department has determined that the potential for human contact is likely.

(B) If the Department declares a Site to be an Emergency Site, money from the Fund will be allocated for the Department to reduce the risk of human exposure. Preference will be given to an action that provides long-term permanent protection without continual maintenance; however, nothing in this section shall preclude the Department from employing temporary measures or technologies to reduce the risk of exposure as deemed appropriate. The Department will notify all exposed individuals and may select the appropriate remedy after consultation with the exposed individuals.

33.15. Restoration Priority List.

(A) The prioritization system to be used when ranking sites for remedial action under this regulation will consider the following:

- (1) Age and number of years of operation;
- (2) Types of Drycleaning Solvent used;
- (3) Location in relation to affected or potentially affected receptors; and,
- (4) The likelihood of contamination migrating to the population or resources.

(B) Sites can be removed from the prioritization list for the following reasons:

- (1) An assessment by the Department shows no evidence of contamination;
- (2) Restoration of the site is completed; or,
- (3) The Site is deemed ineligible.

SUBPART E

Restoration

33.16. General Provisions.

The goal of the restoration phase will be to alleviate any known existing exposure pathway where the clean-up goals are exceeded. The clean-up goals for each Site will be determined on a site specific basis and will be based on the appropriate risk based criteria and/or standards established by the Department.

33.17. Detailed Facility Investigation.

(A) The purpose of the detailed facility investigation is to collect data to determine the nature and extent of contamination at a Site and to support evaluation and selection of restoration alternatives. The detailed facility investigation can include, but may not be limited to, the following:

- (1) Physical characteristics of the site, including important surface and subsurface features, soil types, and hydrogeology.
- (2) The general characteristics of the Drycleaning Solvent waste in the source areas, including quantity, physical state, concentration, and potential mobility.
- (3) Actual and potential exposure pathways including inhalation, ingestion, and dermal adsorption.

(B) A detailed facility investigation work plan will be developed. The work plan will describe the number, type, and location of samples to be collected and the type of analysis to be performed.

(C) A detailed facility investigation report shall be developed after the completion of the field work. The report will summarize the information and data collected during the investigation. In addition, the report will evaluate potential treatment alternatives that will meet the restoration objectives of subsection 33.18.

33.18. Restoration Goals and Evaluation.

(A) The Department will evaluate the restoration alternatives presented in the approved detailed facility investigation report. The selection criteria shall consider:

(1) The effectiveness of the technology to eliminate or reduce the existing and potential risks, hazards, and concerns of Drycleaning Solvents both during implementation and following completion of the selected restoration;

(2) The ability to implement a remedy as it relates to the degree of difficulty associated with construction and management of the remedy, including the technical, administrative, and logistic problems that affect the resources necessary to complete the restoration;

(3) Compliance with Federal and State environmental laws; and,

(4) The capital cost, both direct and indirect, and the annual management and maintenance costs.

(B) The Department will publish a notice of availability and a brief explanation of the proposed restoration alternatives in a major local newspaper of general circulation. The Department will present the findings of the detailed facility investigation and the proposed plan in a public meeting and will accept written comments for a period of not less than thirty calendar days after the meeting.

(C) The Department will review the public comments to determine if the proposed restoration alternative remains the most appropriate alternative for the Site.

(D) The Department will document the evaluation process, including response to public comments, and the selected restoration alternative, in the administrative record for the Site.

33.19. Restoration Implementation.

(A) The Department will review and approve a restoration design report developed by the selected contractor, which will include the actual design and provisions for the implementation of the selected restoration as documented in subsection 33.18(D).

(B) The Department will review the restoration on a periodic basis to ensure that the goals are met to eliminate or reduce the existing and potential risks, hazards, and concerns of Drycleaning Solvents in the environment. In the event that the technology does not achieve the stated goals, the Department will select another remedy after public participation as detailed in subsection 33.18.

HISTORY: Added by State Register Volume 21, Issue No. 6, Part 2, Doc. No. 2071, eff June 27, 1997. Amended by State Register Volume 41, Issue No. 5, Doc. No. 4705, eff May 26, 2017.

Editor's Note

Reprinted in 2016 to include reserved items which were inadvertently omitted from the main volume.

61-34. RAW MILK FOR HUMAN CONSUMPTION.

(Statutory Authority: S.C. Code §§ 44-1-140(3) and 44-1-150)

Editor's Note

HISTORY: Amended by State Register Volume 33, Issue No. 6, eff June 26, 2009; SCSR 46-4 Doc. No. 5033, eff April 22, 2022.

Table of Contents

SECTION I.	Definitions and Standards
SECTION II.	Adulterated or Misbranded Raw Milk or Raw Milk Products
SECTION III.	Permits
SECTION IV.	Inspection of Dairy Farms and Plants Producing and Packaging Raw Milk and Raw Milk Products for Human Consumption
SECTION V.	The Examination of Raw Milk and Raw Milk Products for Human Consumption
SECTION VI.	Labeling
SECTION VII.	Standards for Raw Milk and Raw Milk Products for Human Consumption
SECTION VIII.	Standards for Further Processing of Raw Milk Products
SECTION IX.	Bottling, Packaging, Container Filling, and Container Closure/Sealing
SECTION X.	Animal Health
SECTION XI.	Recall
SECTION XII.	Enforcement
SECTION XIII.	Delayed Implementation
SECTION XIV.	Severability Clause

SECTION I. Definitions and Standards.

A. The following definitions shall apply in the interpretation and the enforcement of this Regulation:

1. Abnormalities of Milk means

- a. Abnormal Milk: Milk that is visibly changed in color, odor, and/or texture.
- b. Undesirable Milk: Milk that, prior to the milking of the animal, is known to be unsuitable for sale, such as colostrum.
- c. Contaminated Milk: Milk that is not sellable or is unfit for human consumption following treatment of the animal with veterinary products, i.e. antibiotics, which have withhold requirements or treatment with medicines or insecticides not approved for use on dairy animals by the United States Food and Drug Administration (FDA) or the United States Environmental Protection Agency (EPA).

2. Adulterated: means raw milk or raw milk products are deemed to be adulterated if the product:

- a. Bears or contains any poisonous or deleterious substance in a quantity that may render it injurious to health;
- b. Bears or contains any added poisonous or deleterious substance for which no safe tolerance has been established by state or federal regulation, or is in excess of such tolerance if one has been established;
- c. Consists, in whole or in part, of any substance unfit for human consumption;
- d. Has been produced, processed, prepared, packaged, or held under unsanitary conditions;
- e. Is packaged in a container which is composed, in whole or in part, of any poisonous or deleterious substance which may render the contents injurious to health;
- f. Has any substance added thereto or mixed or packaged therewith so as to increase its bulk or weight, or reduce its quality or strength, or make it appear better or of greater value than it is;
- g. Is in violation of Section 402 of the Federal Food, Drug, and Cosmetic Act, as amended (21 U.S.C. 342); or
- h. Contains any animal drug residues.

3. Automatic Milking Installation (AMI) means the entire installation of one (1) or more automatic milking units, including the hardware and software utilized in the operation of individual automatic milking units, the animal selection system, the automatic milking machine, the milk cooling system, the system for cleaning and sanitizing the automatic milking unit, the teat cleaning system, and the alarm systems associated with the process of milking, cooling, cleaning, and sanitation.

4. Buttermilk means a cultured dairy product that is produced by culturing milk or cream with characterizing microbial organisms and which contains at least 3.25% milkfat and at least 8.25% milk solids not fat.

5. Clean means the effective and thorough removal of product and/or contaminants from direct product contact surfaces.

6. Code of Federal Regulations (CFR) means the current Code of Federal Regulations.

7. Common Name means the generic term commonly used for domestic animals, i.e., cattle, goats, sheep, horses, water buffalo, etc.

8. Craft Usage means the use of raw milk to create products such as soap, candles, or other non-edible products.

9. Cream means a dairy product that is composed of the higher-fat layer separated from the top of milk and which contains at least 18% milkfat.

10. Dairy Farm means any place or premises where one (1) or more lactating animals (cows, goats, sheep, water buffalo, or other hooved mammals) are kept for milking purposes and from which a part or all of the milk or milk products are provided, sold, or offered for sale.

11. Department means the South Carolina Department of Health and Environmental Control and its representatives.

12. Drug means:

a. A substance recognized in the official United States Pharmacopeia, official Homeopathic Pharmacopeia of the United States, or official National Formulary, or any supplement to any of them;

b. A substance intended for use in the diagnosis, cure, mitigation, treatment, or prevention of disease;

c. A substance (other than food) intended to affect the structure or any function of the body; and

d. A substance intended for use as a component of a substance specified in clause a, b, or c but does not include devices or their components, parts, or accessories.

13. Goat Milk means the normal lacteal secretion, practically free of colostrum, obtained by the complete milking of one (1) or more healthy goats. Goat milk sold in retail packages shall contain not less than 2.5 percent milkfat and not less than 7.5 percent milk solids not fat. Goat milk shall be produced according to the sanitary standards of this Regulation.

14. Kefir means a cultured dairy product that is produced by fermentation of milk by *Lactobacillus bulgaricus*, *Lactobacillus acidophilus*, and *Lactobacillus caucasicus* and which contains not less than 3.5% milk fat or, if made from goat milk, not less than 2.8% milkfat.

15. Milk means the normal lacteal secretion of hooved mammals, practically free of colostrum, obtained by the complete milking of one (1) or more healthy hooved mammals. This product shall be produced according to the sanitary standards of this Regulation. Hooved mammals milk shall include bovine milk, goat milk, sheep milk, water buffalo milk, etc.

16. Milk or Milk Products Distributor means any person who offers for sale milk or milk products that have been packaged at a permitted location.

17. Milk or Milk Products Plant means any place, premises, or establishment where milk or milk products are collected, handled, processed, and stored or prepared for distribution.

18. Milk or Milk Products Producer means any person who operates a dairy farm and provides, sells, or offers milk or milk products for sale that were produced at the farm.

19. Misbranded Milk or Milk Product means any milk or milk product when:

a. The product's container bears or accompanies any false or misleading written, printed, or graphic matter;

b. The milk or milk product does not conform to the definitions as contained in this Regulation; or

c. The product is not labeled in accordance with this Regulation.

20. Officially Designated Laboratory means a commercial laboratory authorized to do official work by the Department or a milk industry laboratory officially designated by the Department for the examination of producer samples of SC Grade A raw milk and raw milk products for human consumption and commingled milk tank truck samples of raw milk and raw milk products for drug residues and bacterial limits.

21. Person means any individual, producer, distributor, plant operator, partnership, corporation, company, firm, trustee, association, or institution.

22. Raw Milk means milk that has not received any heat treatment such as pasteurization or any other further processing.

23. Raw Milk Products means unpasteurized buttermilk, kefir, or cream.

24. Risk means the likelihood that an adverse health effect will occur within a population as a result of a hazard in a food.

25. Sanitization means the application of any effective method or substance to a clean surface for the destruction of pathogens and of other organisms as far as is practical. Such treatment shall not adversely affect the equipment, the milk or milk product, or the health of consumers and shall be acceptable to the Department.

26. Sheep Milk means the normal lacteal secretion practically free of colostrum, obtained by the complete milking of one (1) or more healthy sheep. Sheep milk shall be produced according to the sanitary standards of this Regulation.

27. Water Buffalo Milk means the normal lacteal secretion, practically free of colostrum, obtained by the complete milking of one (1) or more healthy water buffalo. Water buffalo milk shall be produced according to the sanitary standards of this Regulation.

B. Standards.

All raw milk and raw milk products for human consumption shall be bottled, packaged, and sealed at the same location where they were produced, or, in the case of raw milk products, at a location under the direct control of the raw milk producer that has been approved by the Department, and all raw milk and raw milk products shall conform to the chemical, physical, bacteriological, and temperature standards as well as the sanitation requirements of this Regulation.

HISTORY: Amended by State Register Volume 33, Issue No. 6, eff June 26, 2009; SCSR 46-4 Doc. No. 5033, eff April 22, 2022.

SECTION II. Adulterated or Misbranded Raw Milk or Raw Milk Products.

A. No person shall, within South Carolina or its jurisdiction, produce, provide, sell, offer, barter, or expose for sale, or have in possession with intent to sell any raw milk or raw milk product that is adulterated or misbranded.

B. Any adulterated or misbranded raw milk or raw milk product may be impounded by the Department and disposed of in accordance with applicable laws or regulations.

C. Raw milk and raw milk products will be examined by the Department in the course of routine or complaint inspections, outbreak investigations, or as otherwise deemed appropriate by the Department to determine that they are not adulterated or misbranded. The Department may, upon written notice to the owner or person in charge, place a hold order on any raw milk or raw milk product that it determines, or has probable cause to believe, to be unwholesome or otherwise adulterated or misbranded. Under a hold order, raw milk and raw milk products shall be permitted to be suitably stored. It shall be unlawful for any person to remove or alter a hold order, notice, or tag placed on raw milk or raw milk products by the Department, and neither such raw milk or raw milk products nor the containers thereof shall be relabeled, repacked, reprocessed, altered, disposed of, or destroyed without permission of the Department except if ordered by a court of competent jurisdiction.

D. Adding water to raw milk will be considered a violation of this Regulation if the raw milk contains in excess of three percent (3%) water. A cryoscope shall be used to determine percentage of water by measuring the freezing point of the raw milk. When the freezing point of raw milk is greater than 32.945°F (-0.525°C), the farm shall be notified that the raw milk apparently contains added water. If a second violation of this freezing point standard occurs within two (2) years, milking or processing operations may be observed, and samples will be collected and analyzed. The freezing point obtained from raw milk collected during the observation shall be used to determine a definite freezing point standard from the farm. A violation of the determined freezing point standard for a specific operation by over three (3%) percent within two (2) years of setting the standard for the individual farm shall call for a two (2) calendar day permit suspension or equivalent.

E. When raw milk or raw milk products are found to be adulterated by the presence of drugs, pesticides, herbicides, or other poisonous substances, they shall be placed under a hold order and additional samples analyzed. Raw milk or raw milk products found to be adulterated shall be disposed of until analysis shows the product not to be adulterated. If testing reveals raw milk or raw milk products are positive for drug residues, the raw milk or raw milk products shall be disposed of in a manner that removes it from the human or animal food chain. The Department shall immediately suspend the producer's SC Grade "A" permit, or equally effective measures shall be taken, to prevent the sale or distribution of raw milk or raw milk products containing drug residues, and a penalty shall be imposed. Future sales or distribution are prohibited until subsequent testing reveals the raw milk or raw milk products are free of drug residue. The SC Grade "A" producer's permit may be reinstated to allow the sale or distribution of raw milk or raw milk products when a representative sample taken by the Department from the producer's raw milk or raw milk products is no longer positive for drug residue. Whenever a drug residue test is positive, a recall shall be initiated, and an investigation shall be made to determine the cause. The farm inspection must be completed by the Department to

determine the cause of the residue and actions that need to be taken to prevent future violations, including on-farm changes in procedures necessary to prevent future occurrences.

HISTORY: Amended by State Register Volume 33, Issue No. 6, eff June 26, 2009; SCSR 46-4 Doc. No. 5033, eff April 22, 2022.

SECTION III. Permits.

A. It shall be unlawful for any person who does not possess a permit from the Department to manufacture, bring into, send into, or receive into South Carolina or its jurisdiction, have in storage, sell, barter, or offer for sale therein, or offer to give away any raw milk or raw milk products defined in this Regulation, including but not limited to raw milk for craft usage.

B. Raw milk and raw milk products that have been manufactured under the provisions of this Regulation may be further distributed or sold at retail locations in South Carolina by distributors and retailers. Distributors and retailers are not required to have a permit, provided that the product has not been repackaged or relabeled.

C. Although distributors and retailers listed in Section III.B do not require a permit, the Department retains the authority to conduct an investigation in response to a complaint. The Department may require corrective action and issue orders as deemed necessary in response to food safety or health risks identified during the investigation.

D. Only a person who complies with the requirements of this Regulation shall be entitled to receive and retain a permit. Permits shall not be transferable to other persons and/or locations or used by a person other than the permit holder.

E. Every producer of raw milk or raw milk products for human consumption shall hold a valid permit issued by the Department prior to beginning operation. No permit shall be issued until all parts of the operation meet the requirements of this Regulation.

F. The production, distribution, storage, and sale of unpasteurized milk products other than the raw milk products defined in this Regulation (unpasteurized buttermilk, kefir, and cream) are prohibited in South Carolina and will be considered to be violations of this Regulation, except that aged raw milk cheese may be produced in accordance with the provisions of R.61-36, Manufactured Grade Dairy Products.

G. The addition of flavoring or other ingredients to raw milk or raw milk products other than cultures, citric acid, or salt needed for the processing of buttermilk and kefir is prohibited; provided, kefir may also contain harmless edible stabilizers subject to the limitations in VIII.C of this Regulation.

H. The Department may deny a permit to produce, distribute or sell raw milk or raw milk products for human consumption when the applicant or facility has a history of noncompliance with other standards, regulations, or statutes governing milk and milk products.

HISTORY: Amended by State Register Volume 33, Issue No. 6, eff June 26, 2009; SCSR 46-4 Doc. No. 5033, eff April 22, 2022.

SECTION IV. Inspection of Dairy Farms and Plants Producing and Packaging Raw Milk and Raw Milk Products for Human Consumption.

A. Each dairy farm or plant manufacturing raw milk or raw milk products for human consumption shall be inspected by the Department prior to the issuance of a permit. Following the issuance of a permit, the Department shall inspect each dairy farm or plant at a frequency determined by the risk level assigned to the product(s) being manufactured or distributed, or as otherwise deemed necessary by the Department. Inspections of dairy farms will be made at milking time when possible.

B. The Department shall conduct inspections and investigations as are necessary for the enforcement of this Regulation.

C. The inspector will notify the owner or other responsible person of the intent to inspect upon arrival at the premises.

D. A copy of the inspection report will be provided, either electronically or in paper form, to the permit holder, manager, or other duly authorized representative.

E. Every raw milk producer shall, upon request of a Department representative, permit the Department access to all parts of the establishment or facilities to determine compliance with the

provisions of this Regulation. A permit holder, manager, or other duly authorized representative shall furnish the Department, upon request and for official use only, a true statement of the actual quantities of raw milk or raw milk product purchased and sold, and a list of all sources of ingredients, records of inspections, records of tests, and cooling time and temperature records.

F. Should a violation of any requirement set forth in Section VII or Section VIII be found to exist on an inspection, a second inspection shall be required after the time deemed necessary to remedy the violation, but not before three (3) calendar days. Any violation of a requirement of Section VII or Section VIII may result in enforcement action pursuant to Section XII of this Regulation. When the Department at any time finds that a critical processing element violation involving conditions whereby direct contamination of raw milk or raw milk products is occurring, the Department shall take immediate action to prevent transfer from the vessel or location of such raw milk or raw milk products until such violations of critical processing element(s) have been corrected.

G. It shall be unlawful for any person who, in an official capacity, under the provisions of this Regulation obtains any information of disposition of milk, or results of inspections or tests thereof to use such information to his/her own advantage or to reveal it to any unauthorized person.

HISTORY: Amended by State Register Volume 33, Issue No. 6, eff June 26, 2009. Renumbered from § V and amended by SCSR 46-4 Doc. No. 5033, eff April 22, 2022.

SECTION V. The Examination of Raw Milk and Raw Milk Products for Human Consumption.

A. Samples of raw milk or raw milk products for human consumption may be taken for analysis for public health purposes, at any reasonable time or place, and examined for any other public health reason by the Department.

B. Samples of raw milk and raw milk products for human consumption shall be collected and tested prior to a permit being issued. No permit shall be issued until the milk and milk products meet the requirements of Section VII and Section VIII.

C. The producer shall provide to the Department satisfactory pathogenic testing results prior to:

1. receiving a permit and beginning production and/or distribution; or
2. reinstatement of a permit that has been suspended because of positive results of testing for pathogenic organisms in association with a suspected outbreak of disease. In testing associated with a suspected outbreak of disease, the Department shall provide up to two (2) tests at no cost to the producer; pathogen testing required beyond these two (2) tests shall be the responsibility of the producer.

D. Samples of raw milk and raw milk products shall be collected by the producer or the Department, as directed, at a frequency that is deemed appropriate by the Department based on the level of risk of the product. The Department will require sampling for bacterial counts, somatic cell counts, coliform, cooling temperatures, drugs, pesticide residue, and/or pathogenic organisms as deemed appropriate by the Department. Sampling will be conducted in accordance with Department standard operating procedures for sampling of raw milk and raw milk products.

E. Whenever two (2) of the last four (4) consecutive bacterial counts, somatic cell counts, coliform determinations, or cooling temperatures, taken on separate days, exceed the standard for the raw milk or raw milk products as defined in this Regulation, the Department shall send written notice thereof to the person concerned. This notice shall be in effect so long as two (2) of the last four (4) consecutive samples exceed the standard. An additional sample shall be taken within twenty-one (21) calendar days of the sending of such notice, but not before the lapse of three (3) calendar days. The Department shall suspend the permit in accordance with Section XII whenever the standard is violated by three (3) of the last five (5) bacterial counts, coliform determinations, cooling temperatures, or somatic cell counts.

F. When sampling for pathogenic organisms is conducted in association with a suspected outbreak of disease, and the samples test positive for pathogenic organisms, such positive finding of pathogenic organisms shall be considered an imminent health hazard, and the product involved shall be disposed of and not be offered for sale. The Department shall immediately suspend the permit. The permit shall remain suspended until a representative sample containing a minimum of two (2) consecutive milkings are found to be free of pathogenic organisms.

G. Samples shall be analyzed at an official or appropriate officially designated laboratory. All sampling procedures and required laboratory examinations shall be in substantial compliance with the latest edition of Standard Methods for the Examination of Dairy Products (SMEDP) of the American Public Health Association, and the latest edition of Official Methods of Analysis (OMA) of the Association of Official Agricultural Chemists (AOAC) International. Such procedures, including the certification of sample collectors, and examinations shall be evaluated in accordance with the Evaluation of Milk Laboratories.

H. All violations of bacteria, coliform, somatic cell counts, and cooling temperature standards shall be followed by inspection, if needed, to determine and correct the cause.

HISTORY: Amended by State Register Volume 33, Issue No. 6, eff June 26, 2009. Renumbered from § VI and amended by SCSR 46-4 Doc. No. 5033, eff April 22, 2022.

SECTION VI. Labeling.

A. All bottles, containers, and packages enclosing raw milk or raw milk products for human consumption shall be labeled in accordance with the applicable requirements of the Federal Food, Drug and Cosmetic Act as amended, the Nutrition Labeling and Education Act (NLEA) of 1990 and regulations developed thereunder, and the Code of Federal Regulations, and shall comply with the applicable requirements of this section.

B. No person shall use any misleading marks, words, or endorsements upon the label. The Department may permit the use of registered trade designs or similar terms on the bottle cap or label when, in its opinion, they are not misleading and are not used to obscure the labeling required by the Regulation.

C. All bottles, containers, and packages enclosing raw milk or raw milk products for human consumption shall be conspicuously marked with:

1. The word "Raw" on the exterior surface. Acceptable locations shall include the principal display panel, the secondary or informational panel, or the cap/cover.

2. The identity of the farm where packaged. This identity shall include the name and the Department Permit Number.

3. The following consumer advisory, in print no smaller than six (6) point font, shall be included on the package: "This is a raw milk product that is not pasteurized. Consuming raw milk products may increase your risk of foodborne illness."

4. The common name of the hooved mammal producing the milk shall precede the name of the milk or raw milk product when the product is made from other than cattle's milk. As an example, "Goat," "Sheep," "Water Buffalo," or "Other Hooved Mammal" milk, respectively.

D. Raw milk that has had cream separated from it must also be labeled as per Section VIII.B.3.

E. The term Grade "A" Raw may only be used with the designation of SC to read "SC Grade 'A' Raw". Other grade designations may not be used.

F. Descriptive labeling terms such as "wholesome" or "healthy" must not be used. The label must not be false or misleading. The use of the term "cultured" is allowed and optional for buttermilk and kefir.

G. A permit holder's label and Department permit number are not transferable and may only be used by that permit holder.

HISTORY: Amended by State Register Volume 33, Issue No. 6, eff June 26, 2009. Renumbered from § IV and amended by SCSR 46-4 Doc. No. 5033, eff April 22, 2022.

SECTION VII. Standards for Raw Milk and Raw Milk Products for Human Consumption.

A. General

1. All raw milk and raw milk products for human consumption shall be produced to conform with the following chemical, bacteriological, and temperature standards, and the sanitation requirements of this section.

2. No process or manipulation other than appropriate refrigeration shall be applied to raw milk or raw milk products for the purpose of removing or deactivating microorganisms.

Table 1. Chemical, Physical, Bacteriological, and Temperature Standards

SC GRADE "A" RAW MILK AND RAW MILK PRODUCTS FOR HUMAN CONSUMPTION	Temperature	Raw milk: Cooled to 10°C (50°F) or less within four (4) hours or less, of the commencement of the first milking, and to 7°C (45°F) or less within two (2) hours after milking, provided, that the blend temperature after the first and subsequent milkings does not exceed 10°C (50°F). Raw milk and raw milk products: All finished, processed, and packaged raw milk and raw milk products shall be maintained at 7°C (45° F) or less after processing, during storage, and during transportation. Production of buttermilk shall also meet the requirements of Section VIII.A.3.
	Bacterial Limits	Individual producer raw milk and raw milk products not to exceed 10,000 per mL
	Drugs	No positive results on drug residue detection methods
	Somatic Cell Count*	Individual producer raw milk not to exceed 500,000 per mL.
	Coliform	Not to exceed 10 per gram.
	Pathogenic Organisms: **Escherichia Coli	Individual producer: raw milk and raw milk products not to exceed zero (0) organisms
	**0157:H7	Individual producer: raw milk and raw milk products not to exceed zero (0) organisms
	**Salmonella	Individual producer: raw milk and raw milk products not to exceed zero (0) organisms
	**Listeria Monocytogenes	Individual producer: raw milk and raw milk products not to exceed zero (0) organisms
	**Campylobacter	Individual producer: raw milk and raw milk products not to exceed zero (0) organisms

* Goat Milk 1,000,000 per mL: when greater than 1,000,000, additional confirmatory or screening tests will be used.

** Pathogenic testing required before permitting and in association with a foodborne disease outbreak. See Section V.C.1, V.C.2, and V.F.

B. Sanitation Requirements for SC Grade "A" Raw Milk and Raw Milk Products for Human Consumption.

1. Milk with Abnormalities

a. Lactating animals which show evidence of the secretion of milk with abnormalities in one (1) or more quarters, based upon bacteriological, chemical, or physical examination, shall be milked last or with separate equipment and the milk shall be discarded as the Department may direct.

b. Lactating animals that have been treated with, or have consumed, chemical, medicinal, or radioactive agents, which are capable of being secreted in the milk and which, in the judgment of the Department, may be deleterious to human health, shall be milked last or with separate equipment and the milk disposed of as the Department may direct.

c. Raw milk or raw milk products from lactating animals being treated with medicinal agents, which are capable of being secreted in the milk, shall not be offered for sale for such period as is

recommended by the attending veterinarian or as indicated on the package label of the medicinal agent.

d. Raw milk or raw milk products from lactating animals treated with or exposed to insecticides not approved for use on dairy animals by the United States Environmental Protection Agency shall not be offered for sale.

e. The Department may require additional tests for the detection of milk with abnormalities as it deems necessary.

f. Bloody, stringy, off-colored milk, or milk that is abnormal to sight or odor, shall be handled and disposed of as to preclude the infection of other lactating animals and the contamination of milk utensils.

g. Lactating animals secreting milk with abnormalities shall be milked last or in separate equipment which effectively prevents the contamination of the wholesome supply. Milking equipment used on animals with abnormalities in their milk shall be maintained clean to reduce the possibility of re-infecting or cross infection of the dairy animals.

h. Equipment, utensils, and containers used for the handling of milk with abnormalities shall not be used for the handling of raw milk or raw milk products to be offered for sale, unless they are first cleaned and effectively sanitized.

i. Processed animal waste derivatives used as a feed ingredient for any portion of the total ration of the lactating dairy animal shall:

(1) Be properly processed in accordance with at least those requirements contained in the Model Regulations for Processed Animal Wastes developed by the Association of American Feed Control Officials; and

(2) Not contain levels of deleterious substances, harmful pathogenic organisms, or other toxic substances which are secreted in the milk at any level that may be harmful to human health.

j. Unprocessed poultry litter and unprocessed recycled animal body discharges shall not be fed to lactating dairy animals.

2. Milking Barn, or Parlor Construction

A milking barn or parlor shall be provided on all dairy farms in which the milking herd shall be housed during milking time operations.

a. All floors must be constructed of concrete or equally impervious material. Floors shall be easily cleaned and shall be graded to drain and maintained in good repair and free of excessive breaks or worn areas that may create pools.

b. Walls and ceilings shall be smooth, painted, or finished in an approved manner, and be in good repair. Ceilings shall be dust-tight; approved materials include wood, tile, smooth-surfaced concrete, cement plaster, brick, or other equivalent materials with light colored surfaces. Walls, partitions, doors, shelves, windows, and ceilings shall be kept in good repair; and surfaces shall be refinished whenever wear or discoloration is evident. Whenever feed is stored overhead, ceilings shall be constructed to prevent the sifting of chaff and dust into the milking barn, stable, or parlor. If a hay opening is provided from the loft into the milking portion of the barn, such opening shall be provided with a dust-tight door which shall be kept closed during milking operations.

c. Separate stalls or pens for horses, calves, and bulls shall be provided. Such portions of the barn that are not separated by tight partitions shall comply with all requirements of this item.

d. Natural and/or artificial light well distributed for day and/or night milking must be provided to ensure that all surfaces and particularly the working areas will be plainly visible. The equivalent of at least ten (10) foot-candles (110 lux) of light in all working areas shall be provided.

e. Sufficient air space and air circulation to prevent condensation and excessive odors must be provided.

f. There must be no overcrowding by the presence of calves, cows, or other barnyard animals in walk or feed alleys. Inadequate ventilation and excessive odors may also be evidence of an overcrowded barn.

g. There must be dust-tight covered boxes or bins, or separate storage facilities for ground, chopped, or concentrated feed. A dust-tight partition, provided with doors that are kept closed

except when in actual use, shall separate the milking portion of the barn from any feed room or silo in which feed is ground or mixed, or in which sweet feed is stored. When conditions warrant, the Department may approve a barn without four (4) walls extending from floor to roof, or a shed-type barn provided the requirement of Section VII.B.3, which prohibits animals and fowl from entering the barn, is satisfied. Lactating animal-housing areas (stables without stanchions, such as loose housing stables, pen stables, resting barns, free stall barns, holding barns, loafing sheds, and wandering sheds) may be of shed-type construction, provided no milking is conducted therein. (These structures are classified as part of the cowyard under Section VII.B.4.)

h. The Department may grant a variance or waiver from one or more of the requirements of paragraphs VII.B.2.a through VII.B.2.g when, in the opinion of the Department, a health hazard or nuisance will not result from the variance or waiver.

3. Milking Barn, Stable, or Parlor Cleanliness

a. The interior of the milking barn, stable, or parlor shall be kept clean. Floors, walls, ceilings, windows, pipelines, and equipment shall be free of filth and/or litter and shall be clean. Outside surfaces of pipeline systems located in the milking barn, stable, or parlor must be kept reasonably clean.

b. Gutter cleaners must be kept reasonably clean.

c. Swine and fowl shall be kept out of the milking barn.

d. Feed shall be stored in a manner that will not increase the dust content of the air or interfere with the cleaning of the floor (as in covered, dust-tight boxes or bins). Open feed dollies or carts may be used for distributing the feed, but not storing food, in the milking area.

e. Food mangers shall be kept clean so as not to attract flies; leftover feed in feed mangers must appear fresh and not be wet or soggy.

4. Cowyard

a. The cowyard, which is interpreted to be the enclosed or unenclosed area approximately adjacent to the milking barn in which the lactating animals may congregate, including animal-housing areas and feed lots, shall be graded and drained and shall have no standing pools of water or accumulations of organic wastes.

b. Wastes from the barn, milkroom, or processing room shall not be allowed to pool in the cowyard. Depressions and soggy areas shall be filled, and lactating animal lanes kept reasonably dry. Cowyards which are muddy due to recent rains should not be considered as violating this item.

c. Manure, soiled bedding, and waste feed shall not be stored or permitted to accumulate in such a manner as to permit the soiling of lactating animals' udders and flanks. Animal-housing areas (stables without stanchions, such as loose-housing stables, pen stables, resting barns, holding barns, loafing sheds, wandering sheds, free-stall housing) shall be considered part of the cowyard. Manure packs shall be solid to the footing of the animal.

d. In loafing or lactating animal housing areas, lactating animal droppings and soiled bedding shall be removed, or clean bedding added, at sufficiently frequent intervals to prevent the soiling of the lactating animal's udder and flanks.

e. Waste feed shall not be allowed to accumulate.

f. Swine shall be kept out of the cowyard.

g. Cowyards shall be kept reasonably free of animal droppings. Animal droppings shall not be allowed to accumulate in piles that are accessible to the animals.

5. Milkroom or Processing Room—Construction and Facilities

a. A separate milkroom and/or processing room of sufficient size shall be provided, in which the cooling, handling, further processing, and storing of milk and the washing, sanitizing, and storing of milk containers and utensils shall be conducted, except as provided for in Section VII.B.12 of this Regulation.

b. Every milkroom and processing room shall be provided with a smooth floor constructed of concrete or equally impervious material graded to drain and maintained in good repair. Floors shall be sloped to drains so that there are no pools of standing water. Liquid waste shall be

disposed of in a sanitary manner; all floor drains shall be accessible and shall be trapped if connected to a sanitary sewer system.

c. The joints between floors and walls shall be watertight.

d. The walls and ceilings shall be constructed of smooth material, in good repair, well painted, or finished in an equally suitable manner. Surfaces and joints shall be tight and smooth. Acceptable materials include sheet metal, tile, cement block, brick, concrete, cement plaster, or similar materials of light color. Surfaces up to splash height shall be non-absorbent and easily cleanable.

e. Every milkroom and processing room shall have adequate natural and/or artificial light and be well ventilated. A minimum of twenty (20) foot-candles (220 lux) of light shall be provided at all working areas from natural and/or artificial light for milkroom and processing room operations.

f. The milkroom and processing room shall be used for no other purpose than milkroom and processing room operations; there shall be no direct opening into any barn, stable, parlor or into a room used for domestic purposes. A direct opening between the milkroom or processing room and milking barn, stable or parlor is permitted when a tight-fitting self-closing solid door(s) hinged to be single or double acting is provided and opens outward from the milk room. A vestibule, if used, must comply with the applicable milkroom and processing room construction requirements. Screened vents in the wall between the milkroom or processing room and a breezeway, which separates the milkroom or processing room from the milking parlor, are permitted, provided animals are not housed within the milking facility.

g. Water under pressure shall be piped into the milkroom and/or processing room.

h. Every milkroom and processing room shall be adequately ventilated to minimize odors and condensation on floors, walls, ceilings, and clean utensils.

i. Vents, if installed, and lighting fixtures shall be located to preclude the contamination of bulk milk tanks or clean utensil storage area.

j. The milkroom and/or processing room shall be equipped with a wash-and-rinse vat having at least two (2) compartments. Each compartment must be of sufficient size to accommodate the largest utensil or container used. The cleaning-in-place vat for milk pipelines and milk machines may be accepted as one (1) part of the two (2)-compartment vat; provided that the cleaning-in-place station rack in or on the vat and milking machine inflations and appurtenances are completely removed from the vat during the washing, rinsing, and/or sanitizing of other utensils and equipment. Where mechanical cleaning/recirculated systems eliminate the need for handwashing of equipment, the presence of the second wash vat compartment may be optional if so determined by the Department on an individual farm basis.

k. Each milkroom and/or processing room shall be provided with facilities for heating water in sufficient quantity and to such temperatures for the effective cleaning of all equipment and utensils.

6. Milkroom and Processing Room - Cleanliness

a. The floors, walls, ceilings, windows, tables, shelves, cabinets, wash vats, non-product contact surfaces of milk containers, utensils, and equipment, and other milkroom or processing room equipment shall be kept clean. Vestibules, if provided, shall be kept clean.

b. Only articles directly related to milkroom or processing room activities shall be permitted in the milkroom or processing room.

c. The milkroom and processing room shall be kept free of trash, animals, and fowl.

d. Incidental articles such as desks, refrigerators, and storage cabinets may be in the milkroom or processing room provided they are kept clean, ample space is available to conduct the normal operations in the milkroom or processing room, and they will not cause contamination of the milk.

7. Toilet

a. Every dairy farm shall be provided with one (1) or more toilets, conveniently located and properly constructed, operated, maintained and utilized in a sanitary manner. There shall be at least one (1) flush toilet connected to a public sewer system or to an individual sewage-disposal system, or if occupied for less than two (2) hours per day, a portable chemical toilet may be used.

Such sewage systems shall be constructed and operated in accordance with applicable Department regulations and statutes.

b. The waste shall be inaccessible to flies and shall not pollute the soil surface or contaminate any water supply.

c. The toilet room, including all fixtures and facilities, shall be kept clean and free of insects and odors.

d. Where flush toilets are used, doors to toilet rooms shall be tight and self-closing. All outer openings in toilet rooms shall be screened or otherwise protected against the entrance of insects.

8. Water Supply

a. Water for milkroom or processing room and milking operations shall be from an approved supply properly located, protected, and operated, and shall be easily accessible, adequate, and of a safe, sanitary quality.

b. No cross-connection shall exist between a safe water supply and any unsafe or questionable water supply, or any other source of pollution.

c. There shall be no submerged inlets through which a safe water supply may be contaminated.

d. The well or other source of water shall be located and constructed in such a manner that neither underground nor surface contamination from any sewerage systems, privy, or other source of pollution can reach such water supply.

e. New individual water supplies and water supply systems that have been repaired or otherwise become contaminated shall be thoroughly disinfected before being placed in use. The supply shall be made free of the disinfectant by pumping to waste before any sample for bacteriological testing shall be collected.

f. All containers and tanks used in the transportation of water shall be sealed and protected from possible contamination. These containers and tanks shall be subjected to a thorough cleaning and a bacteriological treatment prior to filling with potable water to be used at the dairy farm. To minimize the possibility of contamination of the water during its transfer from the potable tanks to the elevated or groundwater storage at the dairy farm, a suitable pump, hose, and fittings shall be provided. When the pump, hose, and fittings are not being used, the outlets shall be capped and stored in a suitable dust-proof enclosure to prevent their contamination. The storage tank at the dairy farm shall be constructed of impervious material provided with a dust and rainproof cover, as well as with an approved-type vent and roof hatch. All new reservoirs, or reservoirs which have been cleaned, shall be disinfected prior to placing them into service.

g. Samples for bacteriological examination shall be taken upon the initial approval of the physical structure based upon the requirements of this Regulation, when any repair or alteration of the water supply system has been made, and at least every year.

h. Bacteriological examinations shall be conducted in a laboratory acceptable to the Department.

i. Current records of water test results shall be retained on file with the Department or as the Department directs.

9. Utensils and Equipment - Construction

a. All multiuse containers, equipment, and utensils that are exposed to raw milk or raw milk products, or from which liquids may drip, drain or be drawn into raw milk or raw milk products, and used in the handling, storage, or transportation of milk shall be made of smooth, non-absorbent, corrosion-resistant, nontoxic materials, and shall be constructed to be easily cleaned. Acceptable materials include:

(1) Stainless steel of the AISI (American Iron and Steel Institute) 300 series, or equally corrosion-resistant, nontoxic metal;

(2) Heat-resistant glass; or

(3) Plastic or rubber and rubber-like materials which are relatively inert, resistant to scratching, scoring, decomposition, crazing, chipping, and distortion under normal use conditions; are nontoxic, fat resistant, relatively nonabsorbent, and relatively insoluble; do not release compo-

nent chemicals or impart flavor or odor to the product; and which maintain their original properties under repeated use conditions.

b. All containers, utensils, and equipment shall be in good repair and shall be free of breaks, corrosion, pits, cracks, or inclusions.

c. All milk pails used for hand milking and stripping shall be seamless and of the hooded type. Seamless hooded pails having an opening not exceeding one-third the area of that of an open pail of the same size shall be used for hand milking and hand stripping.

d. Strainers, if used, shall be constructed of perforated metal design, or single-service strainer media should be utilized. Multiple-use woven material shall not be used for straining milk.

e. All single-service articles shall be manufactured, packaged, transported, stored, and handled in a sanitary manner and shall comply with the applicable requirements of Section IX. Articles intended for single-service use shall not be reused.

f. Farm holding/cooling tanks, welded sanitary piping, and transportation tanks shall comply with the applicable requirements of Section VII.B.9.a, g, and h.

g. Mechanically cleaned milk pipelines and return-solution lines shall be self-draining. If gaskets are used, they shall be self-positioning and of material meeting specifications described in Section VII.B.9.a.(3), and shall be of such design, finish, and application as to form a smooth, flush interior surface. If gaskets are not used, all fittings shall have self-positioning faces designed to form a smooth, flush interior surface. All interior surfaces of welded joints in pipelines shall be smooth and free of pits, cracks, and inclusions.

h. Mechanically cleaned milk pipelines and return solution lines installed after the effective date of this Regulation shall have welded ferrule/flange fittings; rolled fittings shall not be used.

i. Detailed plans for cleaned-in-place pipeline systems shall be submitted to the Department for written approval prior to installation. No alteration or addition shall be made to any milk pipeline system without prior written approval of the Department.

j. All milking machines, including heads, milk claws, milk tubing, and other milk-contact surfaces shall be constructed to be easily cleaned and inspected. Pipelines, milking equipment, and appurtenances that require a screwdriver or special tool shall be considered easily accessible for inspection, provided the necessary tools are available at the milkroom or processing room. Milking systems shall not have components incorporated in the return solution lines that by design do not comply with the criteria for product-contact surfaces, such as:

- (1) Ball type plastic valves;
- (2) Plastic tees with barbed ridges to better grip the plastic or rubber hoses; and
- (3) PVC water type piping.

k. Milk cans shall have umbrella-type lids.

l. Farm holding/cooling tanks, welded sanitary piping, and transportation tanks shall comply with the applicable requirements of this Regulation.

m. During filling, flexible plastic/rubber hoses may be used between the fill valves of bottom fill and top fill bulk milk storage tanks, when needed for functional purposes. Such hoses shall be drainable, be as short as practical, have sanitary fittings, and be supported to maintain uniform slope and alignment. The end fittings of such hoses shall be permanently attached in such a manner that will assure a crevice-free joint between the hose and the fitting and can be cleaned by mechanical means. The hoses shall be included as part of a mechanical cleaning system.

n. Transparent flexible plastic tubing (up to 150 feet in length) used in connection with milk transfer stations shall be considered acceptable if it meets the "3-A Sanitary Standards for Multiple-Use Plastic Materials Used as Product Contact Surfaces for Dairy Equipment, Number 20" and if it remains sufficiently clear that the interior surfaces can be properly inspected. Short lengths of flexible plastic tubing (eight [8] feet or less) may be inspected for cleanliness by sight or by use of a "rod." The transparency or opacity of such tubing under this condition is not a factor in determining cleanliness.

o. Whenever air under pressure is used for the agitation or movement of milk, or is directed at a milk-contact surface, it shall be free of oil, dust, rust, excessive moisture, extraneous materials, and odor.

10. Utensils and Equipment—Cleaning

a. The product-contact surfaces of all multiuse containers, equipment, and utensils used in the handling, storage, or transportation of raw milk and raw milk products shall be cleaned after each milking or once every twenty-four (24) hours for continuous operations.

b. There shall be a separate wash manifold for all mechanically cleaned milk pipelines in all new or extensively remodeled facilities.

11. Utensils and Equipment - Sanitization

a. The product-contact surfaces of all multiuse containers, equipment, and utensils used in the handling, storage, or transportation of raw milk and raw milk products shall be sanitized before each usage.

b. Sanitization shall be achieved by use of the following methods:

(1) Complete immersion in hot water at a temperature of at least 77°C (170°F), for at least five (5) minutes, or exposure to a flow of hot water at a temperature of at least 77°C (170°F), as determined by the use of a suitable accurate thermometer (at the outlet) for at least five (5) minutes;

(2) Complete immersion for at least one (1) minute in or exposure for at least one (1) minute to a flow of a chemical sanitizer of acceptable strength. All product-contact surfaces must be wetted by the sanitizing solution, and piping so treated must be filled. Sanitizing sprays may be used. Chemical solutions, once used, shall not be reused for sanitizing but may be reused for other purposes; or

(3) By any method which has been demonstrated to be equally effective and approved by the FDA, EPA, or the Department.

12. Utensils and Equipment - Storage

a. All containers, utensils, and equipment used in the handling, storage, or transportation of raw milk and raw milk products, unless stored in sanitizing solutions, shall be stored to assure complete drainage and shall be protected from contamination prior to use, except that pipeline milking equipment such as milker claws, inflations, weigh jars, meters, milk hoses, milk receivers, tubular coolers, plate coolers, milk pumps, and AMI milking equipment which are designed for mechanical cleaning and other equipment, as accepted by FDA, which meets these criteria, may be stored in the milking barn or parlor, provided this equipment is designed, installed, and operated to protect the product and solution-contact surfaces from contamination at all times.

b. Strainer pads, parchment papers, gaskets, and similar single-service articles shall be stored in a suitable container or cabinet and protected against contamination.

13. Utensils and Equipment—Handling

After sanitization, all containers, utensils, and equipment shall be handled in a manner that prevents contamination of any product-contact surface.

a. Sanitized product-contact surfaces, including farm cooling holding tank openings and outlets, shall be protected against contact with unsanitized equipment and utensils, hands, clothing, splash, condensation, and other sources of contamination.

b. Any sanitized product-contact surface which has been otherwise exposed to contamination shall be cleaned and sanitized before being used.

14. Milking—Flanks, Udders, and Teats

a. Milking shall be done in the milking barn or parlor.

b. The flanks, udders, bellies, and tails of all milking cows shall be free from visible dirt. All brushing shall be completed prior to milking.

c. The udders and teats shall be cleaned and treated with a sanitizing solution just prior to the time of milking, and shall be relatively dry before milking. Sanitizing solutions shall be used in accordance with manufacturer specifications and recommendations.

- d. Wet hand milking is prohibited.
- e. Flanks, bellies, tails, and udders shall be clipped as often as necessary to facilitate cleaning of these areas.

15. Drug and Chemical Control

a. Cleaners and Sanitizers

(1) Cleaners and sanitizers shall be stored in dedicated end-use containers which properly identify the contents.

(2) Bulk cleaners and sanitizers that are transferred from the manufacturer's or distributor's container shall be stored only in an end-use container that is properly labeled with the container's contents.

(3) The manufacturer's or distributor's label for each cleaner and sanitizer, including the product name, chemical description, use directions, precautionary and warning statement, first aid instructions, container storage and maintenance instructions and the name and address of the manufacturer or distributor, shall be maintained on the premises and be readily accessible for reference or inspection.

b. Drugs

(1) Drugs shall be properly labeled to include the name and address of the manufacturer or distributor for over-the-counter (OTC) drugs or veterinary practitioner dispensing the product for prescription and extra label use drugs. Drug labels shall also include:

- (a) Directions for use and prescribed withholding times;
- (b) Cautionary statements, if needed; and
- (c) Active ingredient(s) in the drug product.

(2) Drugs dispensed by a pharmacy on the order of a veterinarian shall have labeling that includes the name of the prescribing veterinarian and the name and address of the dispensing pharmacy; the address of the prescribing veterinarian may be included on the labeling.

(3) Drugs intended for treatment of non-lactating dairy animals shall be segregated from those drugs used for lactating animals in separate shelves in cabinets, refrigerators, or other storage facilities.

(4) Unapproved drugs shall not be used and shall not be stored in the milkroom, processing room, milking barn, stable, or parlor.

(5) Animal drugs and drug administration equipment shall be stored in such a way that milk, milking equipment, wash vats, and hand sinks are not subject to contamination by the drugs.

(6) Equipment used to administer drugs shall not be cleaned in the wash vats.

(7) Topical antiseptics and wound dressings, unless intended for direct injection into the teat, vaccines and other biologics, and dosage form vitamins and/or mineral products are exempt from labeling and storage requirements, except when it is determined that they are stored in such a manner that they may contaminate the raw milk or raw milk product-contact surfaces of containers, utensils, or equipment.

16. Milking—Transfer and Protection of Milk

a. Each pail or container of milk shall be taken immediately from the milking barn or parlor to the milkroom or processing room. No milk shall be strained, poured, transferred, or stored outside the milkroom or processing room.

b. The milk receiving receptacle shall be raised above the floor.

17. Personnel

a. Adequate handwashing facilities shall be provided, including a lavatory fixture with hot and cold, or warm running water, soap or detergent, and individual sanitary towels, or other approved hand drying devices, convenient to the milkroom, processing room, milking barn, stable, parlor and flush toilet, and shall be used for no other purpose. Utensil wash and rinse vats shall not be considered as handwashing facilities.

b. Hands shall be washed clean and dried with an individual sanitary towel or other approved hand drying device immediately before milking, before performing any milkroom or processing room function, and immediately after the interruption of any of these activities. Milkers shall wear clean outer garments while milking or handling raw milk, raw milk products, milk containers, utensils, or equipment.

c. No person who by medical examination or supervisory observation is shown to have or appears to have an illness, open lesion (including boils, sores, or infected wounds) or any other abnormal source of microbial contamination shall work at any dairy farm in any capacity that brings them into contact with the production, handling, storage, or transportation of raw milk, raw milk products, containers, equipment, and/or utensils.

d. When reasonable cause exists to suspect the possibility of transmission of infection or disease from any person associated with the handling of raw milk or raw milk products, the Department may:

- (1) Order the immediate exclusion of that person from raw milk handling or handling of raw milk products;
- (2) Order the immediate exclusion of the raw milk or raw milk products concerned from distribution and consumption;
- (3) Order adequate medical and bacteriological examination of the person to determine if an infection or disease is present; or
- (4) Order any combination of the previous measures.

18. Cooling

a. Raw milk shall be cooled to 10°C (50°F) or less within four (4) hours or less of the commencement of the first milking, and to 7°C (45° F) or less within two (2) hours after the completion of milking, and shall be maintained at that temperature, including during packaging and transportation; except that, the blend temperature after the first milking and subsequent milking shall not exceed 10°C (50°F).

b. All finished, processed, and packaged raw milk and raw milk products shall be maintained at 7°C (45° F) or less after processing, during storage, and during transportation.

c. Recirculated cold water that is used in plate or tubular coolers or heat exchangers shall be from a safe source and protected from contamination. Such water shall be tested semiannually and shall comply with the bacteriological standards set by the Department.

19. Vehicles.

Vehicles used to transport raw milk and raw milk products shall be constructed and operated to protect their contents from sun, freezing, and contamination. Such vehicles shall be kept clean, inside and out; no substance capable of contaminating raw milk or raw milk products shall be transported with raw milk or raw milk products.

20. Insect and Rodent Control.

a. Effective measures shall be taken to prevent the contamination of milk, containers, equipment, and utensils by insects and rodents, and by chemicals used to control such vermin.

b. Milkrooms and processing rooms shall be free of insects and rodents.

c. Surroundings shall be kept neat, clean, and free of conditions which might harbor or be conducive to the breeding of insects and rodents.

d. Feed shall be stored in such a manner that it will not attract birds, rodents, or insects.

e. Manure packs in loafing areas, stables without stanchions, pen stables, resting barns, wandering sheds, and free-stall housing shall be properly bedded and managed to prevent fly breeding.

f. Milkrooms and processing rooms shall be effectively screened or otherwise protected against the entrance of vermin, including hose ports and floor drains through walls.

g. Outer milkroom and processing rooms doors shall be tight and self-closing. Screen doors shall open outward.

h. Only pesticides approved for use by the Department and/or registered with the U.S. Environmental Protection Agency shall be used for insect and rodent control.

i. Pesticides shall be used only in accordance with manufacturer's directions.

HISTORY: Amended by State Register Volume 33, Issue No. 6, eff June 26, 2009; SCSR 46-4 Doc. No. 5033, eff April 22, 2022.

SECTION VIII. Standards for Further Processing of Raw Milk Products.

A. Buttermilk

1. All equipment used for the production and processing of buttermilk must be smooth, non-absorbent, and easily cleanable.

2. All ingredients must come from an approved source.

3. The pH of the buttermilk must be maintained at 4.6 or below following production and at the time of packaging, or the product must be maintained at 7°C (45° F) or below. All finished, processed, and packaged buttermilk must meet the requirements of VII.B.18.b.

B. Cream

1. All equipment used for the production and processing of cream must be smooth, non-absorbent, and easily cleanable.

2. Cream must be removed from the raw milk vat by the use of a separator or other method approved by the Department. The hand skimming of cream is prohibited.

3. Raw milk that has had the cream removed shall be labeled as "Raw Milk with Cream Removed."

4. All finished, processed, and packaged cream must meet the requirements of VII.B.18.b.

C. Kefir

1. All equipment used for the production and processing of kefir must be smooth, non-absorbent, and easily cleanable.

2. All ingredients must come from an approved source.

3. The product may contain harmless edible stabilizers not to exceed six-tenths of 1 percent (0.6%). Kefir shall contain no more than 10 coliform bacteria per gram and shall be free of molds, yeasts, and other fungi, and other objectionable bacteria that may impair the quality of the product.

4. Conformance with the requirements of I.A.14 and VIII.C.3 shall be demonstrated by a product assessment conducted by a third-party process authority and provided to the Department by the raw milk processor if requested by the Department.

5. All finished, processed, and packaged kefir must meet the requirements of VII.B.18.b.

HISTORY: Added by SCSR 46-4 Doc. No. 5033, eff April 22, 2022.

SECTION IX. Bottling, Packaging, Container Filling, and Container Closure/Sealing.

A. Bottling, Packaging, and Container Filling.

1. Bottling, packaging, and container filling of raw milk and raw milk products shall be done at the place of production in a sanitary manner by approved mechanical equipment. Bottling, packaging, and container filling of raw milk or raw milk products may be conducted in the milkroom and processing rooms or room.

2. Bottling or packaging machine supply tanks and bowls shall have covers which are smooth and easily cleanable and shall be constructed to prevent any contamination from reaching the inside of the filler tank or bowl. All covers shall be in place during operation.

3. A drip deflector shall be installed on each filler valve. The drip deflector shall be designed and adjusted to divert condensation away from the open container.

4. All containers, seals, and caps shall be from an approved Interstate Milk Shippers listed facility.

5. All containers, seals, and caps shall be handled in a sanitary manner and protected against undue exposure during the operation.

6. When any lubricant is applied to the filler equipment or other milk contact surfaces, the lubricant shall be food grade and applied in a sanitary manner.

7. Containers shall be closed immediately after being filled.

B. Container Closure/Sealing.

1. All container caps, sealers, and closures shall be stored in a clean, dry place protected from insects, rodents, dust, splash, or other contamination.

2. Only new containers, container caps, sealers, and closures shall be used. Reusable glass containers must be approved by the Department prior to use.

3. All container closure/sealing shall be done at the place of production in a sanitary manner by approved mechanical equipment.

4. Hand capping or sealing of containers is prohibited.

5. If suitable mechanical equipment for the capping or closing of specific container(s) of 12.8 liters (three [3] gallons) or more is not available, other methods which eliminate all possibility of contamination may be approved by the Department. Approval of such methods shall be obtained prior to beginning operation.

6. Bottles and packages which have been imperfectly capped, sealed, or closed shall have the contents emptied immediately into approved sanitary containers that are protected from contamination and maintained at 7°C (45°F) or less; when handled and stored properly, the contents may be repackaged in new containers at a later time.

7. All caps, seals, and closures shall be designed and applied so that the sealed container is tamper-evident (removal cannot be made without detection), and the pouring lip shall be protected to at least its largest diameter.

8. Caps, sealers, and closures shall not be left in the equipment at the end of an operating period. Caps, sealers, and closures remaining in the chute between the hopper and the capping device shall be discarded.

9. Loose caps, sealers, and closures may be returned to storage by enclosing them in a clean, protective wrap, plastic bag, or container approved by the Department.

HISTORY: Amended by State Register Volume 33, Issue No. 6, eff June 26, 2009. Renumbered from § VIII and amended by SCSR 46-4 Doc. No. 5033, eff April 22, 2022.

SECTION X. Animal Health.

A. All raw milk and raw milk products for human consumption within South Carolina shall be from healthy animals. Raw milk and raw milk products from unhealthy animals shall not be offered for sale, barter, or be given away, or combined with other raw milk or raw milk products for human consumption.

B. All animals producing raw milk or raw milk products for human consumption shall be free of brucellosis and tuberculosis. Animals showing positive by lesions or a positive test shall be reported to the Department and shall also be reported to the State Veterinarian office in accordance with applicable law.

C. For diseases other than brucellosis and tuberculosis, the Department shall require such physical, chemical, or bacteriological tests as it deems necessary. The diagnosis of other diseases in dairy animals shall be based upon the findings of a licensed veterinarian. Any diseased animal disclosed by such test(s) shall be disposed of as the Department directs.

D. Animals shipped into South Carolina for additions to herds shall have been tested for tuberculosis and brucellosis within thirty (30) calendar days prior to being brought into the state, except that this shall not apply, with regard to brucellosis, to those cattle that have been vaccinated for brucellosis and are under thirty (30) months of age.

E. Records supporting the tests required in this section shall be made available to the Department and be validated with the signature of a licensed veterinarian.

HISTORY: Amended by State Register Volume 33, Issue No. 6, eff June 26, 2009. Renumbered from § IX and amended by SCSR 46-4 Doc. No. 5033, eff April 22, 2022.

SECTION XI. Recall.

Each producer and distributor of raw milk and raw milk products for human consumption shall develop and maintain procedures for the notification of regulatory officials, consumer notification, and product recall, and shall implement any of these procedures as necessary with respect to any product for which the producer, distributor, or the Department knows or has reason to believe circumstances exist that may adversely affect its safety for the consumer. If the Department determines, based upon representative samples, risk analysis, information provided by the producer or distributor, and other information available to the Department, that the circumstances present an imminent hazard to the public health and that a form of consumer notice or product recall can effectively avoid or significantly minimize the threat to public health, the Department may order the producer or distributor to initiate a level of product recall or, if appropriate, issue a form of notification to customers. The producer or distributor shall be responsible for disseminating the notice in a manner designed to inform customers who may be affected by the problem.

HISTORY: Amended by State Register Volume 33, Issue No. 6, eff June 26, 2009. Renumbered from § X and amended by SCSR 46-4 Doc. No. 5033, eff April 22, 2022.

SECTION XII. Enforcement.

A. General.

This Regulation is issued under the authority of Sections 44-1-140(3) and 44-1-150, S.C. Code of Laws, 1976, as amended. It shall be enforced in accordance with interpretations and public health reasons approved by the Department.

B. Penalties.

Any person found to be in violation of this Regulation, in noncompliance with the issued permit, or in violation of an order issued by the Department shall be subject to civil monetary penalties, permit suspension, and/or permit revocation. Each day of continued violation shall be a separate offense.

C. Suspension of Permit.

1. The Department may temporarily suspend a permit whenever:
 - a. It has reason to believe that a public health hazard exists;
 - b. The permit holder has violated any of the requirements of this Regulation;
 - c. The permit holder has violated its permit or an order of the Department, including but not limited to, a hold order;
 - d. The permit holder has interfered with the Department in the performance of its duties, including willful refusal to allow an authorized inspection/audit; or
 - e. The permit holder exhibits hostile behavior toward a representative of the Department during the performance of duty.

2. The Department may, without warning, notice, or hearing, immediately suspend the permit of any producer of raw milk or raw milk products whenever, in the opinion of the Department, an imminent health hazard exists. An imminent health hazard may include, but is not limited to, a willful refusal to permit authorized inspection, serious or repeated violations of bacterial, coliform, somatic cell, or cooling temperature standards, violation of drug residue test standards, or the presence of pathogenic organisms. Upon such suspension of the permit, all processing, bottling, and/or distribution activities shall immediately cease and remain ceased while the permit is suspended. The suspension of permit shall remain in effect until the imminent health hazard has been corrected to the satisfaction of the Department.

3. A suspension of permit shall remain in effect until any violation has been corrected to the satisfaction of the Department.

D. Revocation of Permit.

The Department may revoke a permit for serious or repeated violations of any of the requirements of this Regulation, the permit, or an order of the Department, or for interference with the Department or its representatives in the performance of its duties, including willful refusal to allow an authorized inspection/audit. Notwithstanding any other provisions of this Regulation, the permit may be revoked if any Department representative is threatened with bodily harm or physical interference in the performance of inspectional duties.

E. Reinstatement of Permit.

1. Any producer whose permit has been suspended may submit a written application for the reinstatement of the permit. Any application for the reinstatement of a suspended permit must be in writing and must address all violations underlying the suspension and explain the steps taken to correct those violations.

2. Within seven (7) business days of the receipt of such an application, the Department shall make an inspection of the applicant's establishment, and as many additional inspections thereafter as are deemed necessary, to determine whether the conditions cited in the notice of suspension no longer exist. When the findings justify, the permit shall be reinstated.

3. When the permit suspension has been due to a violation of any of the bacteriological, coliform, somatic cell, cooling temperature, or drug residue test standards, the Department may issue a temporary permit whenever resampling of the herd's milk supply indicates the milk supply to be within acceptable limits as prescribed in Section VII. Samples shall then be taken at the rate of not more than two (2) per week on separate days within a three (3)-week period, and the Department shall reinstate the permit upon compliance with the appropriate standards as determined in accordance with Section V of this Regulation.

4. When a permit has been revoked, the holder of the revoked permit may submit a written application for a new permit; however, the Department may deny a new permit based upon past history, including previous enforcement, suspension, or revocation history.

5. Any person whose permit is revoked shall not be eligible to apply for re-permitting within one (1) year from the date of revocation. Any person whose permit has previously been revoked and who obtains a subsequent permit and violates the provisions of this Regulation, resulting in revocation of the permit for a second time, shall not be granted another permit for a period of five (5) years.

HISTORY: Amended by State Register Volume 33, Issue No. 6, eff June 26, 2009. Renumbered from § XI and amended by SCSR 46-4 Doc. No. 5033, eff April 22, 2022.

SECTION XIII. Delayed Implementation.

Existing raw milk or raw milk products permit holders in operation prior to the effective date of the below listed requirements of this Regulation may use labels that do not comply with those requirements (but which meet all labeling requirements previously in effect) until their existing supply of labels as of the effective date of the below requirements is exhausted or for no more than one (1) year from the effective date of these requirements, whichever is sooner:

1. As provided in Section VI.C.3, all labels shall include the following consumer advisory, in no smaller than six (6) point font: "Consuming raw milk products may increase your risk of foodborne illness."

2. As provided in Section VI.E, labels may only use the term Grade "A" Raw in conjunction with the designation of "SC," to read "SC Grade 'A' Raw". Other grade designations may not be used. Raw milk or raw milk products permit holders permitted after the effective date of the requirements referenced in Section XIII.1 and XIII.2 above must comply with all of the labeling requirements of Section VI without any delayed implementation.

HISTORY: Added by SCSR 46-4 Doc. No. 5033, eff April 22, 2022.

SECTION XIV. Severability Clause.

Should any section, paragraph, sentence, clause, or phrase of this Regulation be declared unconstitutional or invalid for any reason, the remainder of this Regulation shall not be affected thereby.

HISTORY: Amended by State Register Volume 33, Issue No. 6, eff June 26, 2009. Renumbered from § XII and amended by SCSR 46-4 Doc. No. 5033, eff April 22, 2022.

61-34.1. PASTEURIZED MILK AND MILK PRODUCTS.

Editor's Note

Unless otherwise noted, the history for 61–34.1 is as follows: Amended by State Register Volume 17, Issue No. 1, eff Jan 22, 1993; State Register Volume 29, Issue No. 5, eff May 27, 2005.

SECTION I. Applicability of the Grade “A” Pasteurized Milk Ordinance, 2019 Revision

A. The following sections, appendices, and footnotes of the Grade “A” Pasteurized Milk Ordinance (PMO or Ordinance), 2019 Revision, apply in their entirety:

1. Section 4, Labeling;
2. Section 6, The Examination of Milk and/or Milk Products;
3. Section 7, Standards for Grade “A” Milk and/or Milk Products (including Items 1r through 19r, and 1p through 22p);
4. Section 8, Animal Health;
5. Section 9, Milk and/or Milk Products Which May Be Sold;
6. Section 10, Transferring; Delivery Containers; Cooling;
7. Section 11, Milk and/or Milk Products from Points Beyond the Limits of Routine Inspection;
8. Section 12, Plans for Construction and Reconstruction;
9. Section 13, Personnel Health;
10. Section 14, Procedures When Infection or High Risk of Infection Is Discovered;
11. Section 18, Separability Clause;
12. Footnotes; and
13. Appendices A through S.

B. The following associated documents of the Grade “A” Pasteurized Milk Ordinance, 2019 Revision, apply in their entirety:

1. Procedures Governing the Cooperative State - Public Health Service, Food and Drug Administration Program of the National Conference on Interstate Milk Shipments, 2019 Revision (Procedures);
2. Methods of Making Sanitation Ratings of Milk Shippers, 2019 Revision (Methods); and
3. Evaluation of Milk Laboratories, 2019 Revision.

C. The following provisions of the Grade “A” Pasteurized Milk Ordinance, 2019 Revision, apply with the additions, exceptions, and superseding amendments specified below:

1. Section 1, Definitions applies with the following exceptions:
 - a. Definition YY, Regulatory Agency, shall be stricken, and the term “Regulatory Agency,” where used in the Pasteurized Milk Ordinance, 2019 Revision, shall be replaced with the term “Department.” The Department shall mean the South Carolina Department of Health and Environmental Control or its authorized representative.
 - b. Ordinance, as used in the Pasteurized Milk Ordinance, 2019 Revision, shall mean the provisions and appendices of the Pasteurized Milk Ordinance, 2019 Revision, as adopted by the South Carolina Department of Health and Environmental Control (“the Department”).
 - c. “... of ...”, as used in the Pasteurized Milk Ordinance, 2019 Revision, shall mean the state of South Carolina.
 - d. Cross-references to “Section 3. of this *Ordinance*” appearing in Section 5, Section 6, and Appendix N shall mean Section C.3 of this Regulation together with applicable portions of Section 3 of the Ordinance.
2. Section 2, Adulterated or Misbranded Milk and/or Milk Products, applies in its entirety with the following additions:
 - a. The following applies in addition to Section 2:

Milk and milk products shall be examined by the Department as often as may be necessary to determine freedom from adulteration or misbranding. The Department may, upon written notice to the owner or person in charge, place a hold order on any milk or milk product which it determines, or has probable cause to believe, to be unwholesome or otherwise adulterated or misbranded. Under a hold order, milk or milk products shall be permitted to be suitably stored. It shall be unlawful for any person to remove or alter a hold order, notice, or tag placed on milk or milk products by the Department, and neither such milk or milk products nor the containers thereof shall be relabeled, repacked, reprocessed, altered, disposed of, or destroyed without permission of the Department, except on order by a court of competent jurisdiction.

Adding water to raw milk will be considered a violation of this Regulation if the raw milk contains in excess of three percent (3%) water. A cryoscope shall be used to determine percentage of water by measuring the freezing point of the raw milk. When the freezing point of milk and milk products, other than cultured products, is greater than 32.945°F (-0.525°C), the farm or plant owner or manager shall be notified that the milk or milk product apparently contains added water. If a second violation of this freezing point standard occurs within two (2) years, milking or processing operations may be observed, and samples will be collected and analyzed. The freezing point obtained from milk collected during the observation shall be used to determine a definite freezing point standard from the individual farm or plant. A violation of the determined freezing point standard for a specific operation by over three (3%) percent within two (2) years of setting the standard for the individual farm or plant shall call for a two (2) calendar day permit suspension or equivalent.

When milk or milk products are found to be adulterated by the presence of drugs, pesticides, herbicides, or other poisonous substances, they shall be placed under a hold order and additional samples analyzed. Milk or milk products found to be adulterated shall be disposed of until analysis shows the product not to be adulterated. If testing reveals milk or milk products are positive for drug residues, the milk or milk products shall be disposed of in a manner that removes it from the human or animal food chain, except where acceptably reconditioned under FDA Compliance Policy Guide (CPG 7126.20). The Department shall determine the producer(s) responsible for the drug residue violation and immediately suspend the producer's Grade "A" permit or equally effective measures shall be taken to prevent the sale or distribution of milk or milk products containing drug residues, and a penalty shall be imposed. Future pick-ups, sales, or distribution are prohibited until subsequent testing reveals the milk or milk product is free of drug residue. The penalty shall be for the value of all milk on the contaminated load plus any costs associated with the disposition of the contaminated load. The Department may accept certification from the violative producer's milk marketing cooperative or purchaser of milk as satisfying the penalty requirements. The Grade "A" producer's permit may be reinstated, or other action taken, to allow the sale of milk or milk products for human food, when a representative sample taken from the producer's milk or milk products, prior to commingling with any other milk or milk product, is no longer positive for drug residue. Whenever a drug residue test is positive, a recall shall be initiated, and an investigation shall be made to determine the cause. The farm inspection must be completed by the Department to determine the cause of the residue and actions that must be taken to prevent future violations including:

- i. On-farm changes in procedures necessary to prevent future occurrences as recommended by the Department.
- ii. Discussion and education on the Drug Residue Avoidance Control measures outlined in Appendix C of the PMO.

When pasteurized milk or milk products are found to be adulterated by drugs, pesticides, herbicides, or other poisonous substances, the adulterated products shall be removed from the market, disposed of, and sale stopped until analysis proves the product to be free from adulteration.

b. The following applies in addition to the Administrative Procedures part of Section 2:

When two (2) of the last four (4) samples of a pasteurized product are in violation of the milkfat or milk solids not fat standard for that product a warning letter shall be issued by the Department. When three (3) of the last five (5) samples are in violation, the Department shall suspend the permit.

3. Section 3, Permits applies with the following exceptions:

a. The second paragraph on page 17 of the PMO, 2019 Revision (paragraph beginning with "Upon notification") shall not apply.

b. The following replaces the entire Administrative Procedures part of Section 3:

ISSUANCE OF PERMITS: Every milk producer, milk product producer, milk distributor, milk products distributor, bulk milk hauler/sampler, milk tank truck, milk transportation company, milk plant, receiving station, transfer station, and milk tank truck cleaning facility operator shall hold a valid permit prior to beginning operation. No permit shall be issued until all parts of the operation meet the requirements of this regulation. Permits shall not be transferable to other persons/locations or used by a person other than the permit holder. The permit for a milk tank truck(s) may be issued to the milk transportation company. Milk producers who transport milk or milk products only from their own dairy farms; employees of a milk distributor or milk plant operator who possesses a valid permit; and employees of a milk transportation company that possesses a valid permit and transports milk or milk products from a milk plant, receiving station or transfer station shall not be required to possess a bulk milk hauler/sampler's permit. Grocery stores, restaurants, soda fountains and similar establishments where milk and milk products are served or sold at retail, but not processed, may be exempt from the requirements of this Section.

While compliance with the requirements for Grade "A" condensed and dry milk products is necessary to receive and retain a permit for these products, it is not the intent of this Regulation to limit the production of a milk plant that condenses and/or dries milk or milk products to Grade "A" products.

The manufacture of ungraded products for other uses in milk plants operating under a permit for the manufacture of Grade "A" condensed and dry milk products is allowed under conditions specified in Section 7 of the Ordinance and whereby such products are processed, packaged, and stored separately. In such cases, a second permit is required, which is issued with the understanding that ungraded products shall be handled in such a manner so as to avoid confusion with the Grade "A" production.

Either or both permits may be temporarily suspended for the violation of any applicable provision of this Regulation or the Ordinance, or revoked for a serious or repeated violation. Suspension of permits for violation of the sanitation Items of Section 7 is provided for in Section 5 of the Ordinance. In addition, the Department may, at any time, institute court action under the provisions of Section 6 of the Ordinance. There is no specific frequency for the issuance of permits. This should be in accordance with the policies of the Department and in agreement with those employed for the issuance of permits under this Regulation.

SUSPENSION OF PERMIT: The Department may temporarily suspend a permit whenever: it has reason to believe that a public health hazard exists; the permit holder has violated any of the applicable requirements of this Regulation or the Ordinance; the permit holder has violated its permit or an order of the Department, including but not limited to a hold order; the permit holder has interfered with the Department in the performance of its duties, including willful refusal to allow an authorized inspection/audit; or the permit holder exhibits hostile behavior toward a representative of the Department during the performance of its duties. A permit suspension shall remain in effect until any violation has been corrected to the satisfaction of the Department.

The Department may, without warning, notice, or hearing, immediately suspend a permit when, in the opinion of the Department, an imminent health hazard exists. An imminent health hazard may include, but is not limited to, a willful refusal to permit authorized inspection, serious or repeated violations of bacterial, coliform, somatic cell, cooling temperature standards, violation of drug residue test standards, or the presence of pathogenic organisms.

Following permit suspension, all manufacturing, bottling, and/or distribution operations shall immediately cease and remain ceased while the permit is suspended. A suspension of the permit shall remain in effect until the violation(s) and any imminent health hazard have been corrected to the satisfaction of the Department.

REVOCAION OF PERMIT: The Department may revoke a permit whenever the permit holder: has committed serious or repeated violations of any of the applicable requirements of this regulation, the Ordinance, a permit, or an order of the Department, including but not limited to a hold order; or has interfered with the Department in the performance of its duties, including willful refusal to allow an authorized inspection/audit. Notwithstanding any other provisions of this regulation, the permit may be revoked if any Department representative is threatened with bodily harm or physical interference in the performance of inspectional duties.

Following permit revocation, all manufacturing, bottling, and/or distribution operations shall immediately cease and remain ceased.

REINSTATEMENT OF PERMITS: Any permit holder whose permit has been suspended may make written application for the reinstatement of their permit. Any application for the reinstatement of a suspended permit must be in writing and must address all violations underlying the suspension and explain the steps taken to correct those violations.

When the permit suspension has been due to a violation of any of the bacterial, coliform, or cooling temperature standards, the Department, within one (1) week after the receipt of notification for reinstatement of permit, shall issue a temporary permit after determining by an inspection of the facilities and operating methods that the conditions responsible for the violation have been corrected. When a permit suspension has been due to a violation of the somatic cell count standard, the Department may issue a temporary permit whenever a resampling of the herd's milk supply indicates the milk supply to be within acceptable limits as prescribed in Section 7 of the Ordinance. Samples shall then be taken at the rate of not more than two (2) per week on separate days within a three (3) week period. This accelerated sampling applies to bacteria, coliform, somatic cell count, and temperature. The Department shall reinstate the permit upon compliance with the appropriate standard as determined in accordance with Section 6 of the Ordinance.

Whenever the permit suspension has been due to a violation of a requirement other than bacteriological, coliform, somatic cell count, drug residue test, or cooling-temperature standards, the notification shall indicate that the violation(s) has been corrected. Within one (1) week of the receipt of such notification, the Department shall make an inspection/audit of the applicant's facility, and as many additional inspections/audits thereafter as are deemed necessary, to determine that the applicant's facility is complying with the requirements. When the findings justify, the permit shall be reinstated.

When a permit suspension has been due to a positive drug residue, the permit shall be reinstated in accordance with the provisions of Appendix N.

When a permit has been revoked, the holder of the revoked permit may make written application for a new permit; however, the Department may deny a new permit based upon past history, including previous enforcement, suspension, or revocation history. Any person whose permit is revoked shall not be eligible to apply for re-permitting within one (1) year from the date of revocation. Any person whose permit has previously been revoked and who obtains a subsequent permit and violates the provisions of this regulation, resulting in revocation of the permit for a second time, shall not be granted another permit for a period of five (5) years.

4. Section 5, Inspection of Dairy Farms and Milk Plants, applies in its entirety with the exception of:

a. Paragraph 3.c on page 22 in the PMO, 2019 Revision, applies in its entirety with the exception that it shall not apply to milk plants that are not Interstate Milk Shippers (IMS) listed.

b. The fifth paragraph on page 23 in the PMO, 2019 Revision (paragraph beginning with "One (1) copy") is replaced by the following: A copy of the inspection report will be provided, either electronically or in paper form, to the permit holder, manager, or other duly authorized representative.

c. The last sentence of the first paragraph on page 25 in the PMO, 2019 Revision (sentence beginning with "After receipt of a notice of violation") is replaced by the following: After receipt of an inspection report identifying a violation, but before the allotted time has elapsed, the milk producer, bulk milk hauler/sampler, responsible person for the milk tank truck, milk tank truck

cleaning facility, milk plant, receiving station, transfer station, or distributor shall have an opportunity to request extension of the time allowed for correction.

5. Section 7, Item 7p, Water Supply, applies in its entirety with the addition of the following:

At a minimum, the water system must meet the state requirements for a category 3 small water system.

6. The following replaces the language of Section 15, Enforcement, in its entirety:

a. This Regulation is adopted and enforced under the authority of S.C. Code Section 44-1-140 and Section 44-1-150. All applicable provisions of the Ordinance shall be enforced by the Department in accordance with this Regulation and the *Grade "A" PMO*, with Administrative Procedures, current edition, as applicable.

b. Compliance with all provisions of the Appendices adopted in this Regulation shall be deemed a requirement of the Ordinance and this Regulation.

c. Any person found to be in violation of this Regulation or an applicable requirement of the Ordinance, in noncompliance with an issued permit, or in violation of an order issued by the Department shall be subject to civil monetary penalties, permit suspension, and/or permit revocation.

7. The following replaces the language of Section 16, Penalty, in its entirety:

Violations shall be punishable in accordance with S.C. Code Section 44-1-150. Each day of continued violation shall be a separate offense.

8. Section 17, Repeal and Date of Effect of the PMO, 2019 Revision, shall not apply.

9. Appendix T applies in its entirety with the exception that it shall not apply to milk plants that are not IMS listed.

10. The following additional language applies in accordance with the Footnotes in the Ordinance:

The Department regulates cottage cheese, dry curd cottage cheese, and reduced fat or low-fat cottage cheese under the terms of the Ordinance. The additional provisions specified in Footnotes 7 through 13 for regulatory agencies that regulate such products are hereby adopted and incorporated by reference into the relevant portions of the Ordinance and this Regulation.

HISTORY: Amended by State Register Volume 39, Issue No. 6, Doc. No. 4497, eff June 26, 2015; SCSR 46-4 Doc. No. 5033, eff April 22, 2022.

SECTION II. Deleted by State Register Volume 39, Issue No. 6, Document No. 4497, eff June 26, 2015.

Editor's Note

Former R. 61-34.1 § III was titled **ADULTERATED OR MISBRANDED MILK OR MILK PRODUCTS**.

SECTION III. Deleted by State Register Volume 39, Issue No. 6, Document No. 4497, eff June 26, 2015.

Editor's Note

Former R. 61-34.1 § III was titled **PERMITS**.

SECTION IV. Deleted by State Register Volume 39, Issue No. 6, Document No. 4497, eff June 26, 2015.

Editor's Note

Former R. 61-34.1 § IV was titled **LABELING**.

SECTION V. Deleted by State Register Volume 39, Issue No. 6, Document No. 4497, eff June 26, 2015.

Editor's Note

Former R. 61-34.1 § V was titled **INSPECTION OF DAIRY FARMS AND MILK PLANTS**.

SECTION VI. Deleted by State Register Volume 39, Issue No. 6, Document No. 4497, eff June 26, 2015.

Editor's Note

Former R. 61-34.1 § VI was titled **THE EXAMINATION OF MILK AND MILK PRODUCTS**.

SECTION VII. Deleted by State Register Volume 39, Issue No. 6, Document No. 4497, eff June 26, 2015.

Editor's Note

Former R. 61-34.1 § VII was titled **STANDARDS FOR MILK AND MILK PRODUCTS**.

SECTION VIII. Deleted by State Register Volume 39, Issue No. 6, Document No. 4497, eff June 26, 2015.

Editor's Note

Former R. 61-34.1 § VIII was titled **ANIMAL HEALTH**.

SECTION IX. Deleted by State Register Volume 39, Issue No. 6, Document No. 4497, eff June 26, 2015.

Editor's Note

Former R. 61-34.1 § IX was titled **MILK AND MILK PRODUCTS WHICH MAY BE SOLD**.

SECTION X. Deleted by State Register Volume 39, Issue No. 6, Document No. 4497, eff June 26, 2015.

Editor's Note

Former R. 61-34.1 § X was titled **TRANSFERRING, DELIVERY CONTAINERS, COOLING**.

SECTION XI. Deleted by State Register Volume 39, Issue No. 6, Document No. 4497, eff June 26, 2015.

Editor's Note

Former R. 61-34.1 § XI was titled **MILK AND MILK PRODUCTS FROM POINTS BEYOND THE LIMITS OF ROUTINE INSPECTION**.

SECTION XII. Deleted by State Register Volume 39, Issue No. 6, Document No. 4497, eff June 26, 2015.

Editor's Note

Former R. 61-34.1 § XII was titled **FUTURE DAIRY FARMS AND MILK PLANTS**.

SECTION XIII. Deleted by State Register Volume 39, Issue No. 6, Document No. 4497, eff June 26, 2015.

Editor's Note

Former R. 61-34.1 § XIII was titled **PERSONNEL HEALTH**.

SECTION XIV. Deleted by State Register Volume 39, Issue No. 6, Document No. 4497, eff June 26, 2015.

Editor's Note

Former R. 61-34.1 § XIV was titled **PROCEDURE WHEN INFECTION OR HIGH RISK OF INFECTION IS DISCOVERED**.

SECTION XV. Deleted by State Register Volume 39, Issue No. 6, Document No. 4497, eff June 26, 2015.

Editor's Note

Former R. 61-34.1 § XV was titled **ENFORCEMENT**.

SECTION XVI. Deleted by State Register Volume 39, Issue No. 6, Document No. 4497, eff June 26, 2015.

Editor's Note

Former R. 61-34.1 § XVI was titled **PENALTY**.

SECTION XVII. Deleted by State Register Volume 39, Issue No. 6, Document No. 4497, eff June 26, 2015.

Editor's Note

Former R. 61-34.1 § XVII was titled **IMPLEMENTATION**.

SECTION XVIII. Deleted by State Register Volume 39, Issue No. 6, Document No. 4497, eff June 26, 2015.

Editor's Note

Former R. 61-34.1 § XVIII was titled **PERMIT FEES**.

SECTION XIX. Deleted by State Register Volume 39, Issue No. 6, Document No. 4497, eff June 26, 2015.

Editor's Note

Former R. 61-34.1 § XIX was titled **UNCONSTITUTIONALITY CLAUSE**.

61-35. [Repealed].

HISTORY: Former Regulation, titled **Imitation Milk, Imitation Milk Products, and Products Made in Semblance of Milk and Milk Products**, repealed by SCSR 44-6 Doc. No. 4902, eff June 26, 2020.

61-36. MANUFACTURED GRADE DAIRY PRODUCTS.

(Statutory Authority: S.C. Code Sections 39-37-120, 44-1-140, and 44-1-150)

TABLE OF CONTENTS

SECTION I.	DEFINITIONS
SECTION II.	ADULTERATED OR MISBRANDED MANUFACTURED GRADE DAIRY PRODUCTS
SECTION III.	COMPLIANCE PROCEDURES
SECTION IV.	LABELING
SECTION V.	INSPECTION OF MANUFACTURED GRADE DAIRY PRODUCTS PLANTS AND MANUFACTURED GRADE DAIRY PRODUCTS DISTRIBUTION STATIONS
SECTION VI.	THE EXAMINATION OF MANUFACTURED GRADE DAIRY PRODUCTS
SECTION VII.	STANDARDS FOR MANUFACTURED GRADE DAIRY PRODUCTS PLANTS AND MANUFACTURED GRADE DAIRY PRODUCTS DISTRIBUTION STATIONS
SECTION VIII.	MANUFACTURED GRADE DAIRY PRODUCTS FROM OUT OF STATE OR OUTSIDE THE UNITED STATES
SECTION IX.	PLANS FOR CONSTRUCTION AND RECONSTRUCTION
SECTION X.	EQUIPMENT AND FACILITIES IN OPERATION PRIOR TO JULY 1, 2020

SECTION XI.	PROCEDURE WHEN INFECTION OR HIGH RISK INFECTION IS SUSPECTED
SECTION XII.	RECALLS
SECTION XIII.	ENFORCEMENT AND PENALTIES
SECTION XIV.	SEVERABILITY CLAUSE

61-36 § I. DEFINITIONS

The following definitions shall apply in the interpretation and the enforcement of this regulation:

A. **ADULTERATED** - a **MANUFACTURED GRADE DAIRY PRODUCT** is deemed to be **ADULTERATED** if the product:

1. Bears or contains any poisonous or deleterious substance in a quantity that may render it injurious to health;
2. Bears or contains any added poisonous or deleterious substance for which no safe tolerance has been established by state or federal regulation, or in excess of such tolerance if one has been established;
3. Consists, in whole or in part, of any substance unfit for human consumption;
4. Has been produced, processed, prepared, packaged, or held under unsanitary conditions;
5. Is packaged in a container which is composed, in whole or in part, of any poisonous or deleterious substance which may render the contents injurious to health;
6. Has any substance added thereto or mixed or packaged therewith so as to increase its bulk or weight, or reduce its quality or strength, or make it appear better or of greater value than it is;
7. Is in violation of Section 402 of the Federal Food, Drug, and Cosmetic Act, as amended (21 U.S.C. 342); or
8. Contains any animal **DRUG** residues.

B. **ALCOHOL INFUSED FROZEN DESSERT**- any **FROZEN DESSERT** that contains five percent (5%) or more alcohol by volume.

C. **APPROVED** - acceptable to the **DEPARTMENT** based on a determination of conformity with principles, practices, and generally recognized standards that protect public health.

D. **ASEPTICALLY PROCESSED MIX** - a **MANUFACTURED GRADE DAIRY PRODUCT** that is hermetically sealed in a container and so thermally processed in conformance with 21 CFR Part 113 and the provisions of this regulation so as to render the product free of **MICROORGANISMS** capable of reproducing in the product under normal non-refrigeration conditions of storage and distribution. The product shall be free of viable **MICROORGANISMS** (including spores) of public health significance.

E. **ASEPTIC PROCESSING** - a process whereby the **MANUFACTURED GRADE DAIRY PRODUCT** has been subjected to sufficient heat processing, and packaged in a **HERMETICALLY SEALED CONTAINER**, to conform to the applicable requirements of 21 CFR Part 113 and the provisions of Section VII A.1.c. of this regulation and maintain the commercial sterility of the product under normal non-refrigerated conditions.

F. **BUSINESS DAY** - every official work day of the week excluding weekends and state holidays.

G. **BUTTER** - the **FOOD** product usually known as **BUTTER** that is made exclusively from **MILK** or cream, or both, with or without salt, and with or without additional coloring matter, and which contains not less than eighty percent (80%) by weight of **MILK** fat. **BUTTER** may contain: (a) **MILK** solids; (b) **APPROVED** bacterial culture; (c) salt; (d) air or inert gas; and (e) **APPROVED** **FOOD** color. **BUTTER** also includes the following **MANUFACTURED GRADE DAIRY PRODUCTS**:

1. **BUTTER WITH (NAMING THE FRUIT, VEGETABLE, OR RELISH)** - **BUTTER** to which any fruit, vegetable, or relish, or any combination thereof, has been added. It may contain less than eighty percent (80%) **MILK** fat if the percentage of **MILK** fat is reduced by the amount of the product added, but the resulting **MILK** fat content must be at least seventy-five (75%).
2. **BUTTER WITH (NAMING THE SEASONING OR FLAVOR)** - **BUTTER** to which a seasoning or a flavor other than that of **BUTTER**, or both, has been added. It must contain at least eighty percent (80%) **MILK** fat.

3. CALORIE-REDUCED BUTTER - the FOOD product usually known as calorie-reduced BUTTER that is prepared from MILK or MILK products or a combination thereof, and which contains at least thirty-nine (39%) MILK fat and not more than fifty percent (50%) of the calories that would normally be present in BUTTER. CALORIE-REDUCED BUTTER may contain: (a) MILK solids; (b) APPROVED bacterial culture; (c) salt; (d) air or inert gas; (e) APPROVED FOOD color; (f) APPROVED emulsifying and stabilizing agents; (g) APPROVED preservatives; and (h) not more than one percent (1%) added edible casein, edible caseinates, or any combination thereof.

4. LIGHT BUTTER OR LITE BUTTER - FOOD product usually known as LIGHT BUTTER or LITE BUTTER, which is prepared from MILK or MILK products or a combination thereof, and which contains at least thirty-nine (39%) MILK fat and not more than sixty percent (60%) MILK fat. LIGHT BUTTER or LITE BUTTER may contain: (a) MILK solids; (b) APPROVED bacterial culture; (c) salt; (d) air or inert gas; and (e) APPROVED FOOD color.

5. WHEY BUTTER - FOOD product usually known as WHEY BUTTER that is prepared from MILK or MILK products or a combination thereof, and which contains at least eighty percent (80%) MILK fat that is recovered from whey, by weight. WHEY BUTTER may contain: (a) MILK solids; (b) APPROVED bacterial culture; (c) salt; (d) air or inert gas; and (e) APPROVED FOOD color.

H. CODE OF FEDERAL REGULATIONS (CFR) - a codification of the general and permanent rules and regulations (administrative LAW) published in the Federal Register by the executive departments and agencies of the federal government of the United States. Citations to the CFR in this regulation refer sequentially to the Title, Part, and Section numbers (e.g., 21 CFR 117.10 refers to Title 21, Part 117, Section 117.10).

I. CHEESE - the fresh or matured product obtained by draining after coagulation of MILK, cream, skimmed or partly skimmed MILK, or a combination of some or all of these products, including any CHEESE that conforms to the requirements of 21 CFR 133, as amended.

J. DEPARTMENT - the South Carolina Department of Health and Environmental Control and its authorized representatives.

K. DRUG - shall mean:

1. articles recognized in the official United States Pharmacopoeia, official Homeopathic Pharmacopoeia of the United States, or official National Formulary, or any supplement to any of them; and

2. articles intended for use in the diagnosis, cure, mitigation, treatment, or prevention of disease in man or other animals; and

3. articles (other than FOOD) intended to affect the structure of any function of the body of man or other animals; and

4. articles intended for use as a component of any articles specified in clauses 1, 2, or 3, but does not include devices or their components, parts, or accessories.

L. EMPLOYEE - permit holder, PERSON in charge, PERSON having supervisory or managerial duties, PERSON on the payroll, family member, volunteer, PERSON performing work under a contractual agreement, or any other PERSON working in a MANUFACTURED GRADE DAIRY PRODUCTS plant or distribution station.

M. EXCLUSION - prevention of a PERSON from working as an EMPLOYEE in a MANUFACTURED GRADE DAIRY PRODUCTS plant or distribution station or entering a MANUFACTURED GRADE DAIRY PRODUCTS plant or distribution station as an EMPLOYEE.

N. FDA - United States Food and Drug Administration.

O. FD&C - United States Food, Drug, and Cosmetic Act, the federal LAWS giving authority to FDA to oversee the safety of FOOD, DRUGS, medical devices and cosmetics, as set forth in 21 U.S.C. Section 301 et seq.

P. FOOD - means FOOD as defined in section 201(f) of the Federal Food, Drug, and Cosmetic Act (FD&C) and includes raw materials and ingredients.

Q. FROZEN DESSERT - as used in this regulation is defined in S.C. Code Ann. Section 39-37-10. They shall also include MIXES used for FROZEN DESSERT manufacturing and products such as gelato and sorbetto made in semblance of those products defined in Section 39-37-10.

R. HERMETICALLY SEALED CONTAINER - a container that is designed and intended to be secure against the entry of MICROORGANISMS and thereby maintain the commercial sterility of its contents after processing.

S. IMITATION MILK AND IMITATION MILK PRODUCTS, SYNTHETIC MILK AND SYNTHETIC MILK PRODUCTS, MILK DERIVATIVES, AND ANY OTHER PRODUCTS MADE IN SEMBLANCE OF MILK OR MILK PRODUCTS - Products made in semblance of MILK and MILK products are products that are made to resemble in form and are intended to be used in substitution for MILK and/or MILK products and that are determined not to be nutritionally inferior to MILK and/or MILK products.

T. IMMINENT HEALTH HAZARD - a significant threat or danger to health that is considered to exist when there is sufficient evidence to show that a product, practice, circumstance, or event creates a situation requiring immediate correction or cessation of operation to prevent illness or injury based on the number of potential illnesses or injuries, and the nature, severity, and duration of the anticipated illness or injury.

U. LAW - applicable local, state, and federal statutes, regulations, and ordinances.

V. MANUFACTURED GRADE DAIRY PRODUCT(S) - refers to all types of dairy based manufactured FOOD products to include CHEESES, BUTTERS, FROZEN DESSERTS (including MIX), and IMITATION MILK and IMITATION MILK PRODUCTS, SYNTHETIC MILK AND SYNTHETIC MILK PRODUCTS, MILK DERIVATIVES, and ANY OTHER PRODUCTS MADE IN SEMBLANCE OF MILK OR MILK PRODUCTS.

W. MANUFACTURED GRADE DAIRY PRODUCTS DISTRIBUTION STATION - any place or PREMISES, except MANUFACTURED GRADE DAIRY PRODUCTS RETAILERS, where MANUFACTURED GRADE DAIRY PRODUCTS are received, stored, and dispensed to retailers (may also be referred to as "Distribution Station").

X. MANUFACTURED GRADE DAIRY PRODUCTS DISTRIBUTOR - any PERSON, except a MANUFACTURED GRADE DAIRY PRODUCTS RETAILER, who receives, stores, and dispenses MANUFACTURED GRADE DAIRY PRODUCTS to retailers (may also be referred to as "Distributor").

Y. MANUFACTURED GRADE DAIRY PRODUCTS MANUFACTURER - any PERSON, except a MANUFACTURED GRADE DAIRY PRODUCTS RETAILER, who manufactures, processes, or freezes MANUFACTURED GRADE DAIRY PRODUCTS for distribution or sale.

Z. MANUFACTURED GRADE DAIRY PRODUCTS PLANT - any place or PREMISES, except MANUFACTURED GRADE DAIRY PRODUCTS RETAILERS, where MANUFACTURED GRADE DAIRY PRODUCTS are manufactured, processed, or frozen for distribution or sale.

AA. MANUFACTURED GRADE DAIRY PRODUCTS RETAILER - any PERSON who sells, serves, or dispenses MANUFACTURED GRADE DAIRY PRODUCTS at retail which have been processed in an APPROVED MANUFACTURED GRADE DAIRY PRODUCTS PLANT.

BB. MICROORGANISMS - means yeasts, molds, bacteria, viruses, protozoa, and microscopic parasites and includes species that are PATHOGENS. The term "undesirable MICROORGANISMS" includes those MICROORGANISMS that are PATHOGENS, that subject FOOD to decomposition, that indicate that FOOD is contaminated with filth, or that otherwise may cause FOOD to be ADULTERATED.

CC. MILK (HOOVED MAMMALS' MILK) - Hooved mammals' MILK is the normal lacteal secretion, practically free of colostrum, obtained by the complete milking of one (1) or more healthy hooved mammals. Hooved mammals for the purpose of this regulation include, but are not limited to, the members of the Order Cetartiodactyla, such as: Family Bovidae (cattle, water buffalo, sheep, goats, yaks, etc.), Family Camelidae (llamas, alpacas, camels, etc.), Family Cervidae (deer, reindeer, moose, etc.), and Family Equidae (horses, donkeys, etc.).

DD. MIX - the unfrozen combination of ingredients of FROZEN DESSERTS except such fruits, nuts, flavors, color, and other ingredients as may be exempted by the DEPARTMENT. MIX shall be PASTEURIZED.

EE. NUISANCE - for purposes of this regulation, a public health NUISANCE, meaning whatever is dangerous to human life or detrimental to health; or whatever structure or PREMISES is not sufficiently ventilated, sewerred, drained, cleaned, or lighted with respect to its intended occupancy.

FF. OFFICIALLY DESIGNATED LABORATORY - a commercial laboratory authorized to do official work by the DEPARTMENT, or a MILK industry laboratory officially designated by the DEPARTMENT for the examination of producer samples of Grade "A" RAW MILK for PASTEURIZATION and commingled MILK tank truck samples of RAW MILK for antibiotic residues and bacterial limits.

GG. OFFICIAL LABORATORY - a biological, chemical, or physical laboratory that is under the direct supervision of the DEPARTMENT.

HH. PASTEURIZATION - the process of heating every particle of MANUFACTURED GRADE DAIRY PRODUCT in properly designed and operated equipment to one of the temperatures given in the following table, and holding the product continuously at or above that temperature for at least the corresponding specified time:

Batch (Vat) PASTEURIZATION	
Temperature	Time
145°F (63°C) *	30 minutes
Continuous Flow (HTST and HHST) PASTEURIZATION	
Temperature	Time
161°F (72°C) *	15 seconds
191°F (89°C)	1.0 second
194°F (90°C)	0.5 second
201°F (94°C)	0.1 second
204°F (96°C)	0.05 second
212°F (100°C)	0.01 second

* If the fat content of the dairy product is ten percent (10%) or greater, or a total solids of eighteen percent (18%) or greater, or if it contains added sweeteners, the specified temperature shall be increased by 5°F (3°C).

Provided, that FROZEN DESSERTS shall be heated to at least the following temperature and time specifications:

Batch (Vat) PASTEURIZATION	
Temperature	Time
155°F (69°C)	30 minutes
Continuous Flow (HTST) PASTEURIZATION	
Temperature	Time
175°F (80°C)	25 seconds
180°F (83°C)	15 seconds

Provided, that MILK for CHEESE making shall be heated to at least the following temperature and time specification:

Batch (Vat) PASTEURIZATION	
Temperature	Time
145°F (63°C)	30 minutes
Continuous Flow (HTST) PASTEURIZATION	
Temperature	Time

161°F (72°C) 15 seconds

Provided, that cream for BUTTER making shall be heated to at least the following temperature and time specifications:

Batch (Vat) PASTEURIZATION	
Temperature	Time
165°F (74°C)	30 minutes
Continuous Flow (HTST) PASTEURIZATION	
Temperature	Time
185°F (85°C)	15 seconds

Provided further that nothing in this definition shall be construed as barring any other process found equivalent to PASTEURIZATION for dairy products, which has been recognized by the FDA as provided in Section 403(h)(3) of the FD&C (21 U.S.C. Section 343(h)(3)), as amended, and which is APPROVED by the DEPARTMENT.

II. PATHOGEN - a microorganism of public health significance.

JJ. PERMIT - the document issued by the DEPARTMENT that authorizes a PERSON or entity to operate a MANUFACTURED GRADE DAIRY PRODUCTS PLANT or MANUFACTURED GRADE DAIRY PRODUCTS DISTRIBUTION STATION.

KK. PERMIT HOLDER - the entity, such as the owner, the owner's agent, or other PERSON, that possesses a valid PERMIT to operate a MANUFACTURED GRADE DAIRY PRODUCTS PLANT or MANUFACTURED GRADE DAIRY PRODUCTS DISTRIBUTION STATION and is legally responsible for its operation.

LL. PERSON - any individual, plant operator, partnership, corporation, company, firm, trustee, association, or institution.

MM. PEST - any objectionable animals or insects including but not limited to birds, rodents, flies, and larvae.

NN. PASTEURIZED MILK ORDINANCE (PMO) - a set of minimum standards and requirements that are established by the FDA for regulating the production, processing, and packaging of Grade "A" MILK.

OO. PREMISES -

1. The physical facility, its contents, its land, and any adjacent or bordering contiguous land or property under the control of the PERMIT HOLDER; or

2. The physical facility, its contents, and land or property not described in (a) of this definition if the facilities and contents are under the control of the PERMIT HOLDER and may impact the MANUFACTURED GRADE DAIRY PRODUCTS PLANT or distribution station personnel, facilities, or operations, and the MANUFACTURED GRADE DAIRY PRODUCTS PLANT or distribution station is only one component of a larger operation such as a healthcare facility, hotel, motel, school, recreational camp, or prison.

PP. RAW MILK - MILK that has not been PASTEURIZED.

QQ. RESTRICTION - limitation of the activities of an EMPLOYEE so that there is no RISK of transmitting a disease that is transmissible through MANUFACTURED GRADE DAIRY PRODUCTS or ingredients and the EMPLOYEE does not work with exposed MANUFACTURED GRADE DAIRY PRODUCTS or ingredients, clean equipment, utensils, linens, or unwrapped single-service or single-use articles.

RR. RETAIL FOOD ESTABLISHMENT - an establishment that sells FOOD products directly to consumers as its primary function. RETAIL FOOD ESTABLISHMENTS include, but are not limited to, grocery stores, convenience stores, roadside stands, farmers markets, and community supported agriculture (CSA) operations. Any business making FOOD (including a farm business) with at least 50.1 percent in direct to individual consumer FOOD sales satisfies the definition of a RETAIL FOOD

ESTABLISHMENT and is exempt from the Bioterrorism Act registration regulations under the 2002 Bioterrorism Act (21 CODE OF FEDERAL REGULATIONS [C.F.R.] 1.225) as a RETAIL FOOD ESTABLISHMENT. The term “consumers” does not include businesses. A RETAIL FOOD ESTABLISHMENT also includes certain farm-operated businesses selling FOOD directly to consumers as their primary function.

SS. RISK - the likelihood that an adverse health effect will occur within a population as a result of a hazard in a FOOD.

TT. SANITIZE - to adequately treat cleaned surfaces by a DEPARTMENT-accepted process that is effective in destroying vegetative cells of PATHOGENS, and in substantially reducing numbers of other undesirable MICROORGANISMS, but without adversely affecting the product or its safety for the consumer.

UU. ULTRA-PASTEURIZED - MANUFACTURED GRADE DAIRY PRODUCT that has been thermally processed at or above 280°F (138°C) for at least two (2) seconds, either before or after packaging, so as to produce a product that has an extended shelf life under refrigerated conditions.

VV. UNEXPOSED PACKAGED FOOD - packaged FOOD that is not exposed to the environment. Additional definitions related to this regulation are found in 21 CFR 117.3, as amended.

HISTORY: Amended by SCSR 44-6 Doc. No. 4902, eff June 26, 2020.

61-36 § II. ADULTERATED OR MISBRANDED MANUFACTURED GRADE DAIRY PRODUCTS

A. No PERSON within South Carolina, or its jurisdiction, shall produce, provide, sell, offer, or expose for sale, or have in possession with intent to sell, any MANUFACTURED GRADE DAIRY PRODUCT that is ADULTERATED or misbranded. Any MANUFACTURED GRADE DAIRY PRODUCT that may contain any unwholesome substance, or that does not conform with an applicable standard of identity or other requirement under Section I for that particular MANUFACTURED GRADE DAIRY PRODUCT, shall be deemed ADULTERATED and/or misbranded.

B. The DEPARTMENT issues PERMITS for the manufacturing of ALCOHOL INFUSED FROZEN DESSERTS. The DEPARTMENT does not regulate the distribution or sale of ALCOHOL INFUSED FROZEN DESSERTS. Compliance with DEPARTMENT requirements under this regulation does not exempt PERSONS engaged in the production, distribution, or sale of ALCOHOL INFUSED FROZEN DESSERTS from any other applicable LAWS governing the sale or distribution of alcoholic products.

C. The DEPARTMENT may place a hold order on a MANUFACTURED GRADE DAIRY PRODUCT that it determines or has reason to believe:

1. Originated from an unAPPROVED source;
2. May be unsafe, unwholesome, ADULTERATED, misbranded, or not honestly presented;
3. Is not labeled according to LAW; or
4. Is otherwise not in compliance with this regulation.

D. The DEPARTMENT may suspend a PERSON’s PERMIT for violating a hold order.

E. The DEPARTMENT may impound, condemn, forbid the sale of, or cause to be removed or destroyed, any FOOD that is determined to be in violation of this regulation, unwholesome, contaminated, ADULTERATED, misbranded, or from an unAPPROVED source.

F. The DEPARTMENT may issue a hold order to a PERMIT HOLDER or to a PERSON who owns or controls the FOOD, as specified above, without prior warning, notice of a hearing, or a hearing on the hold order.

G. The DEPARTMENT may examine MANUFACTURED GRADE DAIRY PRODUCTS as often as necessary to determine freedom from ADULTERATION or misbranding. Under a hold order, MANUFACTURED GRADE DAIRY PRODUCTS shall be suitably stored. It shall be unlawful for any PERSON to remove or alter a hold order, notice, or tag placed on MANUFACTURED GRADE DAIRY PRODUCTS by the DEPARTMENT, and neither such MANUFACTURED GRADE DAIRY PRODUCTS nor the containers thereof shall be relabeled, repacked, reprocessed, altered, disposed of, or

destroyed without permission of the DEPARTMENT, except on order by a court of competent jurisdiction.

H. Whenever MANUFACTURED GRADE DAIRY PRODUCTS are ADULTERATED by DRUGS, pesticides, herbicides, or other poisonous substances, the PERSON or entity in possession of the product shall remove the product from the market, dispose of the product, and stop sale of the product until analysis provides the product to be free from ADULTERATION.

HISTORY: Amended by SCSR 44-6 Doc. No. 4902, eff June 26, 2020.

61-36 § III. COMPLIANCE PROCEDURES

A. PERMIT.

1. It shall be unlawful for any PERSON to manufacture or distribute any MANUFACTURED GRADE DAIRY PRODUCT without a valid PERMIT issued by the DEPARTMENT for the specific MANUFACTURED GRADE DAIRY PRODUCTS PLANT or DISTRIBUTION STATION. Grocery stores, restaurants, and similar establishments where MANUFACTURED GRADE DAIRY PRODUCTS are served or sold at retail, but not processed (other than fountain freezing of APPROVED pasteurized MIX for FROZEN DESSERTS), may be exempt from the requirements of this section.

2. Every MANUFACTURED GRADE DAIRY PRODUCTS PLANT and MANUFACTURED GRADE DAIRY PRODUCTS DISTRIBUTION STATION must obtain a PERMIT. PERMITS are nontransferable with respect to PERSONS and/or locations.

B. Suspension of PERMIT.

1. The DEPARTMENT may suspend a PERMIT whenever:

- a. it has reason to believe that a public health hazard exists;
- b. the PERMIT HOLDER has violated any of the requirements of this regulation;
- c. the PERMIT HOLDER has violated its PERMIT or an order of the DEPARTMENT, including but not limited to, a hold order; or
- d. the PERMIT HOLDER has interfered with the DEPARTMENT in the performance of its duties.

A suspension shall remain in effect until the violation has been corrected to the satisfaction of the DEPARTMENT.

2. The DEPARTMENT may without prior warning or notice, suspend summarily a PERMIT to operate a MANUFACTURED GRADE DAIRY PRODUCTS PLANT or DISTRIBUTION STATION when the DEPARTMENT determines that the operation of the MANUFACTURED GRADE DAIRY PRODUCTS PLANT or DISTRIBUTION STATION, including but not limited to a willful refusal to permit authorized inspection, constitutes an IMMINENT HEALTH HAZARD. Upon summary PERMIT suspension, all manufacturing and distribution operations shall immediately cease. During the process, the PERMIT shall remain suspended unless the IMMINENT HEALTH HAZARD has been corrected.

3. Any MANUFACTURED GRADE DAIRY PRODUCTS MANUFACTURER or MANUFACTURED GRADE DAIRY PRODUCTS DISTRIBUTOR whose PERMIT has been suspended may make written application for the reinstatement of the PERMIT.

4. Within seven (7) BUSINESS DAYS of receiving the written application, the DEPARTMENT shall make inspections and/or collect samples for analysis to determine whether the conditions cited in the notice of suspension no longer exist. If conditions warrant, the DEPARTMENT may reinstate the PERMIT.

C. Revocation of PERMIT.

1. The DEPARTMENT may revoke a PERMIT for repeated violations of any of the requirements of this regulation, the PERMIT, or an order of the DEPARTMENT, or for interference with the DEPARTMENT or its staff in the performance of its duties. Notwithstanding any other provisions of this regulation, the PERMIT may be revoked if the DEPARTMENT is threatened with bodily harm or physical interference in the performance of inspectional duties.

2. The DEPARTMENT may deny a new PERMIT based upon past noncompliance, including previous enforcement, suspension, or revocation history.

3. Any PERSON whose PERMIT is revoked shall not be eligible to apply for re-permitting within one (1) year from the date of revocation. Any PERSON whose PERMIT has previously been revoked and who obtains a subsequent PERMIT and violates the provisions of this regulation, resulting in revocation of the PERMIT for a second time, shall not be granted another PERMIT for a period of five (5) years.

HISTORY: Amended by SCSR 44-6 Doc. No. 4902, eff June 26, 2020.

61-36 § IV. LABELING

MANUFACTURED GRADE DAIRY PRODUCTS must be labeled according to the requirements in 21 CFR Part 101, as amended.

HISTORY: Amended by SCSR 44-6 Doc. No. 4902, eff June 26, 2020.

61-36 § V. INSPECTION OF MANUFACTURED GRADE DAIRY PRODUCTS PLANTS, AND MANUFACTURED GRADE DAIRY PRODUCTS DISTRIBUTION STATIONS

A. Each MANUFACTURED GRADE DAIRY PRODUCTS MANUFACTURER whose MANUFACTURED GRADE DAIRY PRODUCTS are intended for consumption within South Carolina or its jurisdiction shall be inspected by the DEPARTMENT prior to the issuance of a PERMIT.

B. Following the issuance of a PERMIT, the DEPARTMENT will inspect each MANUFACTURED GRADE DAIRY PRODUCTS MANUFACTURER and DISTRIBUTOR at a frequency determined by the RISK level assigned to the product(s) being manufactured or distributed, or as otherwise deemed necessary by the DEPARTMENT to determine compliance with this regulation.

C. When the DEPARTMENT finds a critical processing element violation involving:

1. Improper PASTEURIZATION, whereby every particle of a MANUFACTURED GRADE DAIRY PRODUCT may not have been heated to the proper temperature and held for the required time in properly designed and operated equipment; or

2. Cross contamination whereby direct contamination of a PASTEURIZED MANUFACTURED GRADE DAIRY PRODUCT is occurring; or

3. Conditions whereby direct contamination of a MANUFACTURED GRADE DAIRY PRODUCT is occurring, the DEPARTMENT shall take immediate action to prevent further processing of such MIX or MANUFACTURED GRADE DAIRY PRODUCT until all violations of critical processing element(s) have been corrected. Should correction of such critical processing elements not be accomplished immediately, the DEPARTMENT will take prompt action to suspend the PERMIT as provided for in Section III of this regulation.

D. In the case of a plant producing ASEPTICALLY PROCESSED MIX, when an inspection of the plant or its records reveal that the process used has been less than the required scheduled process, as per the PMO, it shall be considered an IMMINENT HEALTH HAZARD and the DEPARTMENT shall take immediate action to suspend the PERMIT of the plant for the sale of aseptically processed MANUFACTURED GRADE DAIRY PRODUCTS in conformance with Section III of this regulation.

E. A copy of the inspection report will be provided either electronically or in paper form to the PERMIT HOLDER, manager, or other duly authorized representative.

F. Every MANUFACTURED GRADE DAIRY PRODUCTS MANUFACTURER and DISTRIBUTOR shall, upon request of a DEPARTMENT representative, permit the DEPARTMENT access to all parts of the establishment or facilities to determine compliance with the provisions of this regulation. A PERMIT HOLDER, manager, or other duly authorized representative shall furnish the DEPARTMENT, upon request and for official use only, a true statement of the actual quantities of MANUFACTURED GRADE DAIRY PRODUCT purchased and sold, and a list of all sources of such MANUFACTURED GRADE DAIRY PRODUCT, records of inspections, records of tests, and PASTEURIZATION time and temperature records.

G. It is unlawful for any PERSON who, in an official capacity, obtains any information under the provisions of this regulation which is entitled to protection as a trade secret, to use such information to his or her own advantage or to reveal it to any unauthorized PERSON.

HISTORY: Amended by SCSR 44-6 Doc. No. 4902, eff June 26, 2020.

61-36 § VI. THE EXAMINATION OF MANUFACTURED GRADE DAIRY PRODUCTS

A. Sampling criteria.

1. Samples of MANUFACTURED GRADE DAIRY PRODUCTS shall be collected by the manufacturer or the DEPARTMENT, as directed, at a frequency that is deemed appropriate by the DEPARTMENT based on the level of RISK of the product.

2. Samples may be taken while in the possession of the manufacturer and/or distributor, retail stores, cafes, restaurants, and other places where MANUFACTURED GRADE DAIRY PRODUCTS are sold and shall be taken and examined as often as the DEPARTMENT may require.

B. Sampling enforcement.

1. Upon receipt of unsatisfactory samples, as specified in (a) and (b) below, the DEPARTMENT shall send a written notice thereof to the PERMIT HOLDER of the MANUFACTURED GRADE DAIRY PRODUCTS PLANT or MANUFACTURED GRADE DAIRY PRODUCTS DISTRIBUTION STATION.

a. For FROZEN DESSERTS this notice shall be sent when two (2) of the last four (4) consecutive bacterial counts (except those for ASEPTICALLY PROCESSED MIX), coliform determinations, or cooling temperatures, taken on separate days, exceed the limit of the standard for FROZEN DESSERTS. An additional sample shall be taken within twenty-one (21) days of the sending of such notice, but not before the lapse of three (3) days. The DEPARTMENT shall suspend the manufacturer and/or distributor's PERMIT in accordance with Section III and/or take court action as necessary whenever the additional sampling results indicate that three (3) of the last five (5) bacterial counts (except those for ASEPTICALLY PROCESSED MIX), coliform determinations, or cooling temperatures exceed the limit of the standard for FROZEN DESSERTS.

b. For CHEESE and BUTTER, this notice shall be sent when a sample is confirmed to be positive for PATHOGENIC organisms. A positive finding of PATHOGENIC organisms in a sample shall be considered an IMMINENT HEALTH HAZARD, and the product involved shall not be offered for sale. The DEPARTMENT shall immediately suspend the PERMIT and the PERMIT shall remain suspended until a minimum of two (2) consecutive representative samples are found to be free of PATHOGENIC organisms.

2. Whenever a phosphatase test is positive, the cause shall be determined by the PERMIT HOLDER. Where the cause is improper PASTEURIZATION, it shall be corrected, and any MANUFACTURED GRADE DAIRY PRODUCT involved shall not be offered for sale.

3. Whenever a pesticide residue test is positive, an investigation shall be made to determine the cause, and the product involved shall not be offered for sale. The cause shall be corrected. An additional sample shall be taken and tested for pesticide residues and no MANUFACTURED GRADE DAIRY PRODUCT shall be offered for sale until it is shown by a subsequent sample to be free of pesticide residues or below the actionable levels established for such residues.

4. Whenever a DRUG residue test is positive, an investigation shall be made to determine the cause, and the cause shall be corrected in accordance with the provision of Section II of this regulation.

5. Whenever a container or containers of ASEPTICALLY PROCESSED MANUFACTURED GRADE DAIRY PRODUCT is found to be unsterile due to under processing, the DEPARTMENT shall consider this to be an IMMINENT HEALTH HAZARD and shall suspend the PERMIT of the MANUFACTURED GRADE DAIRY PRODUCT plant for the sale of ASEPTICALLY PROCESSED MANUFACTURED GRADE DAIRY PRODUCT. No ASEPTICALLY PROCESSED MANUFACTURED GRADE DAIRY PRODUCT shall be sold until it can be shown that the processes, equipment, and procedures used are suitable for consistent production of a sterile product. All products, including MANUFACTURED GRADE DAIRY PRODUCT, manufactured in or from the lot found to contain one (1) or more unsterile units shall be recalled and disposed of as directed by the DEPARTMENT.

C. Sampling methods.

Samples shall be analyzed at an official or appropriate OFFICIALLY DESIGNATED LABORATORY. All sampling procedures and required laboratory examinations shall be in substantial compliance with the Standard Methods for the Examination of Dairy Products of the American Public Health Association, and the certification of sample collectors, and examinations shall be evaluated in accordance with the United States Public Health Service/FDA Evaluation of MILK Laboratories. Aseptically processed MANUFACTURED GRADE DAIRY PRODUCTS packaged in HERMETICALLY SEALED CONTAINERS shall be tested in accordance with the FDA's Bacteriological Analytical Manual. Examinations and tests to detect adulterants, including pesticides, shall be conducted as the DEPARTMENT requires.

HISTORY: Amended by SCSR 44-6 Doc. No. 4902, eff June 26, 2020.

61-36 § VII. STANDARDS FOR MANUFACTURED GRADE DAIRY PRODUCTS PLANTS AND MANUFACTURED GRADE DAIRY PRODUCTS DISTRIBUTION STATIONS

A. Temperature, bacteriological and chemical requirements.

1. All frozen dessert MIX shall be produced, processed, and PASTEURIZED, ULTRA-PASTEURIZED, or ASEPTICALLY PROCESSED as specified in the PMO and frozen to conform with the following temperature, bacteriological, and chemical standards and the sanitation requirements of this section:

a. RAW MILK and MILK products obtained by a FROZEN DESSERT manufacturer for future PASTEURIZATION, ULTRA-PASTEURIZATION, or ASEPTIC PROCESSING and use in the production of FROZEN DESSERTS must come from an APPROVED source and must be in compliance with the temperature, bacteriological, and chemical standards in R.61-34, Raw Milk for Human Consumption, or R. 61-34.1, Pasteurized Milk and Milk Products, or the PMO.

b. PASTEURIZED FROZEN DESSERTS and/or Heat-Treated, Bulk-Shipped MILK Products:

(1) Temperature - Cooled to 45°F (7°C) or less and maintained thereat.

(2) Bacterial limits * - 30,000 per mL.

(3) Coliform - Not to exceed 10 per mL: provided that, in the case of bulk MILK transport tank shipments, where contents are to be repasteurized, shall not exceed 100 per mL.

(4) Phosphatase ** - Less than 500 milliunits/L by the Fluorometer or Clarion ALP or equivalent.

(5) DRUGS - No positive results on DRUG residue detection methods as referenced in Section 6 - Laboratory Techniques, FDA Grade "A" PMO as amended.

c. ASEPTICALLY PROCESSED MIX:

(1) Temperature - None.

(2) Bacterial limits - No growth by test specified in Section VI.

(3) DRUGS - No positive results on DRUG residue detection methods as referenced in Section 6 - Laboratory Techniques, FDA Grade "A" PMO as amended.

2. Each type of CHEESE shall conform to the sanitation requirements of this section and be produced and processed and PASTEURIZED, ULTRA-PASTEURIZED, and ASEPTICALLY PROCESSED to conform with the temperature, bacteriological, and chemical standards that are outlined below:

a. Except as provided in paragraph A.2.b. below, all MILK and MILK products used in the production of CHEESE shall meet the requirements in either (1) or (2) below:

(1) Be PASTEURIZED or subjected to equivalent heat treatment by the CHEESE manufacturer in accordance with the applicable specifications under the definition of PASTEURIZATION in Section I of this regulation.

a. PASTEURIZATION achieved by methods other than those described in the current PMO must be achieved in accordance with a written procedure that has been APPROVED by the DEPARTMENT; and

b. has been proven by a phosphatase test to achieve PASTEURIZATION.

(2) Be made from PASTEURIZED MILK products or from MILK products which have been subjected to equivalent heat treatment as outlined in Section I of this regulation.

b. If made from RAW MILK (CHEESE labeled as “heat treated”, “unPASTEURIZED”, “RAW MILK”, or “for manufacturing”), CHEESE must be aged for no less than sixty (60) days at a temperature greater than or equal to 35°F (1.7°C) in order to control microbial PATHOGENS.

c. RAW MILK and MILK products obtained by a CHEESE manufacturer for future PASTEURIZATION, ULTRA-PASTEURIZATION, or ASEPTIC PROCESSING and use in the production of CHEESE must come from an APPROVED source and be in compliance with the temperature, bacteriological, and chemical standards in R.61–34, Raw Milk for Human Consumption, or R. 61–34.1, Pasteurized Milk and Milk Products., or the PMO.

d. All CHEESE shall be made from ingredients that conform to the quality specifications for raw materials outlined in 21 CFR 58.430 through 58.437, as amended.

e. Each type of CHEESE must meet the specific standards and limits applicable to it under Subpart B of 21 CFR Part 133, as amended.

3. All BUTTERS shall conform to the sanitation requirements of 21 CFR 117.80 and be produced, processed, and PASTEURIZED, ULTRA-PASTEURIZED, or ASEPTICALLY PROCESSED to conform with the temperature, bacteriological, and chemical standards that are outlined below:

a. All BUTTERS shall be manufactured from MILK or MILK products that have been PASTEURIZED or subjected to equivalent heat treatment in accordance with the applicable specifications under the definition of PASTEURIZATION in Section I of this regulation and shall not be made from RAW MILK or RAW MILK products.

(1) PASTEURIZATION achieved by methods other than those described in the current PMO must be achieved in accordance with a written procedure that has been APPROVED by the DEPARTMENT; and

(2) has been proven by a phosphatase test to achieve PASTEURIZATION.

b. All BUTTERS shall be made from ingredients that conform to the quality specifications for raw materials outlined in 7 CFR 58.322 through 58.331, as amended.

c. BUTTER specifications:

(1) Proteolytic count - Not more than 100 per gram.

(2) Yeast and mold count - Not more than 20 per gram.

(3) Coliform count - Not more than 10 per gram.

(4) Enterococci - Not more than 10 per gram.

4. No process or manipulation other than PASTEURIZATION, ULTRA-PASTEURIZATION or ASEPTIC PROCESSING, freezing, processing methods integral therewith, and appropriate refrigeration (freezing) shall be applied to MANUFACTURED GRADE DAIRY PRODUCTS for the purpose of removing or deactivating MICROORGANISMS.

5. All IMITATION MILK, IMITATION MILK PRODUCTS, AND PRODUCTS MADE IN SEMBLANCE OF MILK AND MILK PRODUCTS shall meet the minimum standards for the MILK or MILK product which it imitates or resembles, including those for fat and solids not fat. To each quart of IMITATION MILK, imitation low-fat MILK, imitation skim MILK, and products made in semblance of these products, 400 U.S.P. units of Vitamin D and 2000 U.S.P. units of Vitamin A shall be added.

B. Post-PASTEURIZATION ingredients.

Only the following flavoring ingredients and other ingredients which have been found to be safe and suitable may be added to a MANUFACTURED GRADE DAIRY PRODUCT after PASTEURIZATION:

1. Fresh fruits and vegetables, provided the resultant equilibrium pH level (4.6 or below when measured at 75°F (24°C)) of the finished product is reached without undue delay and is maintained during the shelf life of the product;

2. Ingredients subjected to prior heating or other technology that has been demonstrated to the FDA to be sufficient to destroy or remove PATHOGENIC MICROORGANISMS;

3. Ingredients having a water activity of 0.85% or less;
4. Ingredients having a high acid content (pH level of 4.6 or below when measured at 75°F (24°C)) or high alkalinity (pH level greater than 11 when measured at 75°F (24°C));
5. Roasted nuts;
6. Dry sugars and salts;
7. Safe and suitable bacterial cultures and enzymes;
8. Alcohol;
9. Ingredients that have been found to be safe and suitable by the FDA.

All such additions shall be made in a sanitary manner that prevents the contamination of the added ingredient or the MANUFACTURED GRADE DAIRY PRODUCT.

C. Sanitation of MANUFACTURED GRADE DAIRY PRODUCTS PLANTS and MANUFACTURED GRADE DAIRY PRODUCTS DISTRIBUTION STATIONS.

1. All MANUFACTURED GRADE DAIRY PRODUCTS MANUFACTURERS and DISTRIBUTORS, regardless of exemption status, shall comply with the requirements of 21 CFR Part 117, Subpart A - General Provisions, Subpart B - Current Good Manufacturing Practice, and Subpart F - Requirements Applying to Records That Must Be Established and Maintained, as amended.

a. In addition to the requirements in Section VII(C)(1) above, BUTTER plants, BUTTER manufacturers, BUTTER distribution stations, and BUTTER distributors shall comply with 7 CFR 58.311 through 58.321, as amended, and 7 CFR 58.332 through 58.344, as amended.

b. In addition to the requirements in Section, VII(C)(1) above, CHEESE plants, CHEESE manufacturers, CHEESE distribution stations, and CHEESE distributors shall comply with 7 CFR 58.406 through 58.429, as amended, and 7 CFR 58.438 through 58.445, as amended.

2. MANUFACTURED GRADE DAIRY PRODUCTS PLANTS and DISTRIBUTION STATIONS that have been granted a Qualified Facility Exemption by the FDA or that are solely engaged in the storage of refrigerated UNEXPOSED PACKAGED FOODS when temperature controls are necessary to prevent PATHOGEN growth shall comply with the requirements of 21 CFR Part 117, Subpart A - General Provisions, Subpart B - Current Good Manufacturing Practice, Subpart D - Modified Requirements, and Subpart F - Requirements Applying to Records That Must Be Established and Maintained, and be familiar with Subpart E - Withdrawal of a Qualified Facility Exemption, as amended.

3. All MANUFACTURED GRADE DAIRY PRODUCTS PLANTS and DISTRIBUTION STATIONS that have not been granted a Qualified Facility Exemption by the FDA shall comply with the requirements of 21 CFR Part 117, Subpart A - General Provisions, Subpart B - Current Good Manufacturing Practice, Subpart C - Hazard Analysis and Risk-Based Preventive Controls, and Subpart F - Requirements Applying to Records That Must Be Established and Maintained, as amended.

4. MANUFACTURED GRADE DAIRY PRODUCTS PLANTS and DISTRIBUTION STATIONS that are requiring a withdrawal of their Qualified Facility Exemption from the FDA shall be subject to the requirements of 21 CFR Part 117, Subpart E - Withdrawal of a Qualified Facility Exemption, as amended.

5. MANUFACTURED GRADE DAIRY PLANTS and DISTRIBUTION STATIONS that have not been granted a Qualified Facility Exemption by the FDA and have identified a hazard requiring a supply-chain applied control shall comply with the requirements of 21 CFR Part 117, Subpart G - Supply-Chain Program, as amended.

6. There shall be separate rooms for processing and packaging of different types of MANUFACTURED GRADE DAIRY PRODUCTS as determined by the DEPARTMENT.

7. Water Supply.

a. Water used for MANUFACTURED GRADE DAIRY PRODUCTS PLANT purposes shall be from a supply properly located, protected, and operated, and shall be easily accessible, adequate, and of a safe, sanitary quality. Any water used as an ingredient must be obtained from an APPROVED public water system as defined in R.61-58. Water for MANUFACTURED GRADE

DAIRY PLANTS that have not been granted a Qualified Facility Exemption by the FDA must be from an APPROVED public water supply.

b. Firms that have been granted a Qualified Facility Exemption by the FDA shall have their water supply tested. Samples for bacteriological testing of individual water supplies may be taken by the DEPARTMENT or by other APPROVED individuals with the results to be submitted to the DEPARTMENT upon the initial approval of the physical structure, annually thereafter, and when any repair or alteration of the water supply system has been made. Examinations shall be conducted in an OFFICIAL LABORATORY at the MANUFACTURED GRADE DAIRY PRODUCT PLANTS expense. The plant must maintain records of the tested samples.

HISTORY: Amended by SCSR 44-6 Doc. No. 4902, eff June 26, 2020.

* Not applicable to cultured products.

** Not applicable to bulk shipped heat-treated products.

61-36 § VIII. MANUFACTURED GRADE DAIRY PRODUCTS FROM OUT OF STATE OR OUTSIDE THE UNITED STATES

MANUFACTURED GRADE DAIRY PRODUCTS from out of state or outside the United States may be sold in South Carolina only if the DEPARTMENT determines they are manufactured and distributed under provisions substantially equivalent to the requirements of this regulation and adequately enforced.

HISTORY: Amended by SCSR 44-6 Doc. No. 4902, eff June 26, 2020.

61-36 § IX. PLANS FOR CONSTRUCTION AND RECONSTRUCTION

Properly prepared plans for all MANUFACTURED GRADE DAIRY PRODUCTS PLANTS or MANUFACTURED GRADE DAIRY PRODUCTS DISTRIBUTION STATIONS regulated under this regulation which are to be constructed, reconstructed, or extensively altered shall be submitted to the DEPARTMENT for written approval before work is begun.

HISTORY: Amended by SCSR 44-6 Doc. No. 4902, eff June 26, 2020.

61-36 § X. EQUIPMENT AND FACILITIES IN OPERATION PRIOR TO JULY 1, 2020

Equipment and physical facilities of MANUFACTURED GRADE DAIRY PRODUCTS PLANTS and MANUFACTURED GRADE DAIRY PRODUCTS DISTRIBUTION STATIONS in operation prior to July 1, 2020 are deemed in compliance even if they do not meet all construction, equipment, and facilities requirements of this regulation if the facilities and equipment:

- A. Are in compliance with the regulatory standards in place for such equipment and facilities on January 1, 2020;
- B. Are capable of being maintained in a sanitary condition;
- C. Are not a public health hazard or NUISANCE; and
- D. Are replaced in the normal course of operation with equipment and facilities that meet the requirements of this regulation.

This section shall not apply to equipment installed or construction commenced on or after July 1, 2020.

HISTORY: Amended by SCSR 44-6 Doc. No. 4902, eff June 26, 2020.

61-36 § XI. PROCEDURE WHEN INFECTION OR HIGH RISK INFECTION IS SUSPECTED

When reasonable cause exists to suspect the possibility of transmission of infection from any PERSON concerned with the handling of MANUFACTURED GRADE DAIRY PRODUCTS, or their ingredients, the DEPARTMENT is authorized to require any or all of the following measures:

- A. The immediate EXCLUSION or RESTRICTION of that PERSON from handling MANUFACTURED GRADE DAIRY PRODUCTS, or their ingredients;

B. The immediate removal of the MANUFACTURED GRADE DAIRY PRODUCTS of concern from distribution and use; and/or

C. Adequate medical and bacteriological examination of the PERSON, of their associates, and any of their bodily discharges.

HISTORY: Amended by SCSR 44-6 Doc. No. 4902, eff June 26, 2020.

61-36 § XII. RECALLS

For MANUFACTURED GRADE DAIRY PRODUCTS MANUFACTURERS and DISTRIBUTORS that have not been granted a Qualified Facility Exemption by the FDA, the Recall Plan requirements of 21 CFR 117.139 supersede the requirements of this section.

If 21 CFR 117.139 does not apply, each MANUFACTURED GRADE DAIRY PRODUCTS MANUFACTURER and MANUFACTURED GRADE DAIRY PRODUCTS DISTRIBUTOR shall develop and maintain procedures for the notification of regulatory officials, consumer notification, and product recall, and shall implement any said procedure as necessary with respect to any product for which the PERMIT HOLDER or the DEPARTMENT has reason to believe circumstances exist that may adversely affect its safety for the consumer. If the DEPARTMENT determines, based upon representative samples, RISK analysis, information provided by the MANUFACTURED GRADE DAIRY PRODUCTS MANUFACTURER and/or MANUFACTURED GRADE DAIRY PRODUCTS DISTRIBUTOR, and/or other information available to the DEPARTMENT, that the circumstances present an IMMINENT HEALTH HAZARD and that a form of consumer notice or product recall can effectively avoid or significantly minimize the threat to public health, the DEPARTMENT may order the MANUFACTURED GRADE DAIRY PRODUCTS MANUFACTURER and/or MANUFACTURED GRADE DAIRY PRODUCTS DISTRIBUTOR to initiate a level of product recall or, if appropriate, issue a form of notification to customers. Each MANUFACTURED GRADE DAIRY PRODUCTS MANUFACTURER and MANUFACTURED GRADE DAIRY PRODUCTS DISTRIBUTOR shall be responsible for disseminating the notice in a manner designed to inform customers who may be affected by the problem.

HISTORY: Amended by SCSR 44-6 Doc. No. 4902, eff June 26, 2020.

61-36 § XIII. ENFORCEMENT AND PENALTIES

Any PERSON found to be in violation of this regulation, in non-compliance with the issued PERMIT, or in violation of an order issued by the DEPARTMENT shall be subject to civil monetary penalties, PERMIT suspension, and/or PERMIT revocation. Each day of continued violation shall be a separate offense.

HISTORY: Amended by SCSR 44-6 Doc. No. 4902, eff June 26, 2020.

61-36 § XIV. SEVERABILITY CLAUSE

Should any section, paragraph, sentence, clause, or phrase of this regulation be declared unconstitutional or invalid for any reason, the remainder of said regulations shall not be affected thereby.

HISTORY: Amended by SCSR 44-6 Doc. No. 4902, eff June 26, 2020.

61-36 § XV. REPEALED

HISTORY: Former Regulation, titled SEVERABILITY CLAUSE, had the following history: Amended by State Register Volume 28, Issue No. 5, eff May 28, 2004. Repealed by SCSR 44-6 Doc. No. 4902, eff June 26, 2020.

61-37. Repealed.

HISTORY: Former Regulation, titled Retail Food Establishment Inspection Fees, had the following history: Added by State Register Volume 24, Issue No. 6, eff June 23, 2000; Amended by State Register Volume 26, Issue No. 6, Part 1, eff June 28, 2002. Repealed by SCSR 43-5, Doc. No. 4842, eff May 24, 2019. See, now, S.C. Code Regs. 61-25.

61-38. Repealed.

HISTORY: Former Regulation, titled Fairs, Camp Meetings, and Other Gatherings, repealed by State Register Volume 40, Issue No. 4, Doc. No. 4552, eff April 22, 2016.

61–39. Repealed.

HISTORY: Former Regulation, titled **Camps**, repealed by State Register Volume 40, Issue No. 4, Doc. No. 4552, eff April 22, 2016.

61–40. Repealed.

HISTORY: Former Regulation, titled **Mobile/Manufactured Home Parks**, repealed by State Register Volume 40, Issue No. 4, Doc. No. 4552, eff April 22, 2016.

61–42. Repealed.

HISTORY: Former Regulation, titled **Sanitation of Schools**, repealed by State Register Volume 40, Issue No. 4, Doc. No. 4552, eff April 22, 2016.

61–43. STANDARDS FOR THE PERMITTING OF AGRICULTURAL ANIMAL FACILITIES.

(Statutory Authority: S.C. Code §§ 44–1–60, 44–1–65, 46–45–80, and 48–1–10 et seq.)

Editor’s Note

The following constitutes the history for 61–43, 50 through 600.

HISTORY: Added by State Register Volume 22, Issue No. 6, Part 2, eff June 26, 1998; Amended by State Register Volume 26, Issue No. 6, Part 2, eff June 28, 2002.

Table of Contents

Part 50	General Definitions.
Part 100	Swine Facilities.
100.10.	Purpose, Applicability, Inactive Facilities, and Facilities Permitted Prior to the Effective Date of the Regulation.
100.20.	Permits and Compliance Period.
100.30.	Exclusions.
100.40.	Relationship to Other Regulations.
100.50.	Permit Application Requirements (Animal Facility Management Plan Submission Requirements).
100.60.	Public Notice Requirements.
100.70.	Permit Decision Making Process.
100.80.	Swine Facility, Lagoon, Treatment System, and Manure Storage Pond Siting Requirements.
100.90.	General Requirements for Swine Manure Lagoons, Treatment Systems, and Swine Manure Storage Ponds.
100.100.	Manure Utilization Area Requirements.
100.110.	Spray Application System Requirements.
100.120.	Frequency of Monitoring for Swine Manure.
100.130.	Dead Swine Disposal Requirements.
100.140.	Other Requirements.
100.150.	Odor Control Requirements.
100.160.	Vector Control Requirements.
100.170.	Record Keeping.
100.180.	Reporting.
100.190.	Training Requirements.
100.200.	Violations.
Part 200	Animal Facilities (other than swine).
200.10.	Purpose, Applicability, Inactive Facilities, and Facilities Permitted Prior to the Effective Date of the Regulation.
200.20.	Permits and Compliance Period.
200.30.	Exclusions.
200.40.	Relationship to Other Regulations.
200.50.	Permit Application Requirements (Animal Facility Management Plan Submission Requirements).
200.60.	Public Notice Requirements.
200.70.	Permit Decision Making Process.

- 200.80. Animal Facility, Lagoon, Treatment System, and Manure Storage Pond Siting Requirements.
- 200.90. General Requirements for Animal Manure Lagoons, Treatment Systems, and Animal Manure Storage Ponds.
- 200.100. Manure Utilization Area Requirements. 200.110. Spray Application System Requirements.
- 200.120. Frequency of Monitoring for Animal Manure.
- 200.130. Dead Animal Disposal Requirements.
- 200.140. Other Requirements.
- 200.150. Odor Control Requirements.
- 200.160. Vector Control Requirements.
- 200.170. Record Keeping.
- 200.180. Reporting.
- 200.190. Training Requirements.
- 200.200. Violations.
- Part 300 Innovative and Alternative Technologies.
 - 300.10. General.
 - 300.20. Submittal Requirements.
 - 300.30. Requirements in Lieu of Requirements Under Part 100 and Part 200 of This Regulation.
 - 300.40. Innovative and Alternative Treatment Technologies.
 - 300.50. Exceptional Quality Compost.
 - 300.60. Public Notice Requirements.
- Part 400 Manure Broker/Land Applier Operations.
 - 400.10. Purpose and Applicability.
 - 400.20. Permits and Compliance Period.
 - 400.30. Relationship to Other Regulations.
 - 400.40. Permit Application Procedures (Broker/Land Applier Management Plan Submission Requirements).
 - 400.50. Permit Decision Making Process.
 - 400.60. Manure Utilization Area Requirements.
 - 400.70. Other Requirements.
 - 400.80. Odor Control Requirements.
 - 400.90. Vector Control Requirements.
 - 400.100. Record Keeping.
 - 400.110. Reporting.
 - 400.120. Training Requirements.
 - 400.130. Violations.
- Part 500 Integrator Registration Program.
 - 500.10. General.
 - 500.20. Submittal Requirements.
 - 500.30. Certificate of Integrator Registration.
 - 500.40. Reporting.
 - 500.50. Other Requirements.
 - 500.60. Violations.
- Part 600 Severability.

PART 50. General Definitions

For purposes of this regulation, the following definitions apply:

“Active Animal Facility” means a facility with a minimum of 30,000 pounds normal production animal live weight and in production.

“Affected Person” means a property owner with standing within a one (1)-mile radius of the proposed building footprint or permitted poultry facility or other animal facility, except a swine facility, who is challenging on his own behalf the permit, license, certificate, or other approval for the failure to comply with the specific grounds set forth in the applicable Department regulations governing the permitting of poultry facilities and other animal facilities, other than swine facilities.

“Agricultural animal” means an animal confined in an agricultural facility.

“Agricultural facility” means a lot, building, or structure, which is used for the commercial production of animals in an animal facility.

“Agronomic rate” means the animal manure and other animal by-products’ application rate designed: (1) to provide the amount of nitrogen needed by the food crop, feed crop, fiber crop, cover crop, or vegetation grown on the land; (2) to minimize the amount of nitrogen in the animal manure that

passes below the root zone of the crop or vegetation grown on the land to groundwater; (3) to provide the amount of other organic and inorganic plant nutrients which promote crop or vegetative growth, such as calcium-carbonate equivalency; and (4) to provide the amount of phosphorus needed by the crop or vegetation grown on the land without causing an excessive buildup of phosphorus in the soil.

“Animal” means any domesticated animal.

“Animal by-product” means a secondary or incidental product of animal production that may include bedding, spilled feed, water or soil, milking center washwater, contaminated milk, hair, feathers, dead animals or other debris. This definition may also refer to dead animal or animal manure compost.

“Animal facility” means an agricultural facility where animals are confined and fed or maintained for a total of forty-five (45) calendar days or more in a twelve (12)-month period and crops, vegetative, forage growth, or post-harvest residues are not sustained in the normal growing season over any portion of the lot or facility. Structures used for the storage of animal manure and other animal by-products from animals in the operation also are part of the animal facility. Two (2) or more animal facilities under common ownership or management are considered to be a single animal facility if they are adjacent.

“Animal Facility Management Plan” means a plan prepared by the United States Department of Agriculture’s Natural Resources Conservation Service (USDA-NRCS) or a professional engineer detailing the management, handling, treatment, storage, or utilization of manure generated in an animal facility. This plan shall include facility management details and a detailed map of each manure utilization area showing all buffer zones and setbacks, a description of the land use, the crops grown on the site, the timing for application of manure to the land and a land use agreement if the site is not owned by the permittee.

“Animal Feeding Operation” means a lot or facility where animals have been, are, or will be stabled or confined and fed for a total of forty-five (45) calendar days or more in any twelve (12)-month period.

“Animal manure” means animal excreta or other commonly associated organic animal manures including, but not limited to, bedding, litter, feed losses, or water mixed with the manure.

“Annual animal manure application rate” means the maximum amount of animal manure that can be agronomically applied to a unit area of land during any 365-day period.

“Annual constituent loading rate” means the maximum amount of a constituent that can be applied to a unit area of a manure utilization area during any 365-day period.

“Application rate” means the amount of manure applied at any one time.

“Approval to Operate (ATO)” means a letter from the Department granting approval to place the facility into operation.

“Average animal live weight” means the sum of the average exit weight of the animal from the facility and the average entry weight divided by two, as shown by the following formula:

$$\text{Average animal live weight} = (\text{Average Exit Weight} + \text{Average Entry Weight})/2$$

“Broker” means a person who accepts or purchases animal manure or other animal by-products from agricultural facilities and transfers this product to a third party for land application.

“Certification of Construction” means a document, certified by the consultant, PE, or NRCS staff, that a certain construction project has been completed in accordance with the terms, conditions, and specifications contained in the permit of applicable regulations.

“Closed facility” means an animal facility that has ceased operations (no confined animals at the facility) and is no longer in production, and all lagoons and waste storage ponds have been properly closed out and cannot be placed back into operation without a new permit.

“Commercial Facility” means an animal facility that produces animals or animal by-products for commercial sale, boards animals, rents animals, or provides a service utilizing the animals for a fee.

“Compost” means an organic soil conditioner that has been stabilized to a humus-like product, is free of viable human and plant pathogens and plant seeds, does not attract insects or vectors, can be handled and stored without nuisance, and is beneficial to the growth of plants.

“Composting” means the biological decomposition and stabilization of organic substrates, under conditions that allow development of thermophilic temperatures as a result of biologically produced heat, to produce a final product that is stable, free of pathogens and plant seeds, and can be

beneficially applied to land. Composting requires special conditions of moisture and aeration to produce thermophilic temperatures.

“Concentrated Animal Feeding Operation (CAFO)” means as defined by the Environmental Protection Agency (EPA).

“Confined Animal Manure Management (Camm) Certification” means an operator, manager, or owner of an animal facility or manure utilization area, has received certification by completing a class and passing an exam that is provided by Clemson University, Clemson Extension, the South Carolina Department of Health and Environmental Control, and the USDA Natural Resource Conservation Service.

“Constituent limit” means a numerical value that describes the amount of a constituent allowed per unit amount of animal manure (e. g., milligrams per kilogram of total solids); the amount of a constituent that can be applied to a unit area of land (e. g., pounds per acre); or the volume of a material that can be applied to a unit area of land (e.g., gallons per acre).

“Cover crop” means a vegetative crop, including, but not limited to, oats, wheat, or barley; grasses; or other crop grown for agronomic use or to maintain topsoil and prevent soil erosion.

“Critical Habitat” means the term used to define those areas of habitat containing physical and biological features that are essential for an endangered or threatened species to recover and that require special management or protection.

“Cumulative constituent loading rate” means the maximum amount of a constituent that can be applied to an area of land.

“Cumulative impacts” means an increase or enlarging of impact to the environment or community by the successive addition or accumulation of animal facilities in an area.

“CWA” means the Clean Water Act (formerly referred to as the Federal Water Pollution Control Act or Federal Water Pollution Control Act Amendments of 1972) Pub. L. 92-500, as amended by Pub. L. 95-217, Pub. L. 95-576, Pub. L. 96-483, and Pub. L. 97-117, 33 U.S.C. 1251 et seq. Specific references to sections within the CWA shall be according to Pub. L. 92-500 notation.

“Deemed Permitted Facility” means an agricultural animal facility that held a valid permit from the Department for their swine facility prior to July 1, 1996, or for their animal facility prior to June 26, 1998.

“Department” means the South Carolina Department of Health and Environmental Control.

“Discharge” means any release, emission or dismissal of sewage, industrial waste, agriculture waste, or other waste into any Waters of the State, whether treated or not.

“Downwind Receptors” means virtual three-dimensional coordinates placed off site where the concentrations of emissions would be measured for comparison to air quality standards.

“Dry manure” means manure, bedding, litter, feed losses, or composted animal material (animal manure or dead animals) that is not in a liquid form. Dry animal manure can normally be easily handled with a shovel or other similar equipment and it can be placed in piles without liquid manure or leachate drainage occurring.

“Dry weight basis” means calculated on the basis of having been dried at 105 degrees Celsius until reaching a constant mass (i.e., essentially 100 percent solids content).

“EPA” means the United States Environmental Protection Agency.

“Ephemeral stream” means a stream that flows only in direct response to rainfall or snowmelt in which discrete periods of flow persist no more than twenty-nine (29) consecutive days per event.

“Evergreen Buffer” means plants such as trees, shrubs, or grasses that have foliage that remain green and functional through at least more than one growing season and are not deciduous.

“Excessive Mortality” means total animal mortality in any one twenty-four (24)-hour period that exceeds the design capacity of the normal method of dead animal disposal. This may include utilizing the barns to compost the excessive mortality.

“Expansion” means an increase in the permitted number of animals or normal production animal live weight that will result in physical construction at the facility. An animal manure treatment lagoon that is converted to an animal manure storage pond is considered an expansion of the facility. For facilities

permitted prior to 1998, where the treatment/storage design function was not clearly specified, the Department shall review the facility's operation records and compliance history to determine the current function and condition of the manure handling structures. If the existing structure can handle additional animals, without physical alteration, significant changes in the original function of the structure, or any significant increase in odor, the Department may allow this increase in animals without classifying the change as an expansion.

"Feedlot" means an animal feeding operation (AFO) which is used in intensive animal farming for finishing livestock.

"FEMA" means the Federal Emergency Management Agency.

"Feed crops" means crops produced primarily for consumption by animals. These include, but are not limited to, corn, grains, and grasses.

"Fiber crops" means crops including, but not limited to, flax and cotton.

"Floodplain" means land adjacent to water bodies that periodically becomes temporarily inundated with water during or after rainfall events. The land inundated from a flood whose peak magnitude would be experienced on an average of once every 100 years is the 100-year floodplain. The 100-year flood has a one percent (1%) probability of occurring in one given year.

"Food crops" means crops produced primarily for human consumption. These include, but are not limited to, fruits, vegetables, and grains.

"Footprint" means the area of ground covered by an agricultural facility (i.e., the part of the property where the animal facility is constructed).

"Freeboard" means additional capacity in a storage/treatment structure designed to provide a safety margin of storage in the event that a rainfall occurs when the structure is full. The design storm is normally a twenty-five (25) year storm of twenty-four (24) hours duration.

"Groundwater" means water below the land surface in the saturated zone.

"Inactive Facility" means an animal facility that is not considered in production, but the facility and/or lagoon(s)/waste pond(s) have not been properly closed out. The owner/operator/permittee will continue to pay the annual fees throughout the inactive period of the permit, will be required to maintain the facility and/or lagoon(s)/waste storage pond(s), and will be inspected by the Department on a routine basis.

"Integrator" or "Integrating company" means any entity or person(s) who contracts with agricultural animal producers to grow animals to be supplied to this person(s) at the time of removal from the animal growing houses or facilities and exercises substantial operational control over an animal facility, along with the owner/operator of the facility. Substantial operational control includes, but is not limited to, the following: directs the activities of persons working at the animal facility either through a contract, direct supervision, or on-site participation; owns the animals; or specifies how the animals are grown, fed, or medicated. This definition does not include independent producers that contract with other independent producers to accomplish a portion of the animal growing process under contract.

"Intermittent stream" means a stream that generally has a defined natural watercourse, which does not flow year-round but flows beyond periods of rainfall or snowmelt.

"Lagoon" means an impoundment used in conjunction with an animal facility, the primary function of which is to store or stabilize, or both, manure, organic wastes, wastewater, and contaminated runoff.

"Land application" means the spraying or spreading of manure or other animal by-products onto the land surface; the injection of manure below the land surface into the root zone; or the incorporation of manure into the soil so that the manure can either condition the soil or fertilize crops or vegetation grown in the soil.

"Land Applier" means any person who accepts or purchases manure or other animal by-products from agricultural facilities for use as a fertilizer or soil enhancer on land either owned, leased, or managed by the land applier.

"Large Animal Facility" means an animal facility (excluding swine facilities) that has a capacity for more than 500,000 pounds and less than 1,000,000 pounds of normal production animal live weight at any one time.

“Large Swine Facility” means a swine facility with a capacity for greater than 500,000 pounds and less than 1,000,000 pounds of normal production animal live weight at any one time.

“Liquid manure” means manure that by its nature, or after being diluted with water, can be pumped easily and is removed, either intermittently or continuously, from an animal lagoon, manure storage pond, or treated effluent from other types of animal manure treatment systems.

“Manure” means the fecal and urinary excretion of livestock and poultry. This material may also contain bedding, spilled feed, water, or soil. It may also include wastes not associated with livestock excreta, such as milking center washwater, contaminated milk, hair, feathers, or other debris. Manure may be described in different categories as related to solids and moisture content, such as dry manure and liquid manure.

“Manure storage pond” means a structure used for impounding or storing manure, wastewater, and contaminated runoff as a component of an agricultural manure management system. Manure is stored for a specified period of time, one (1) year or not less than ninety (90) calendar days, and then the pond is emptied. This definition does not include tanks or other similar vessels.

“Manure utilization area” means land on which animal manure (including swine manure) is spread as a fertilizer and is synonymous with land application site or land application area

“Mass Burial Site” means an area of land approved by the Department designated to be a mass burial site for excessive mortality.

“NRCS” means the Natural Resources Conservation Service of the United States Department of Agriculture.

“NRCS-CPS” means the Natural Resources Conservation Service’s Conservation Practice Standards as given in the USDA-NRCS, SC Handbook of Conservation Practices.

“Normal production animal live weight at any one time” means the maximum number of animals at the facility at any one time multiplied by the average animal live weight of those animals.

“Notice of Intent (NOI)” means a document provided by the Department used by an applicant to notify the surrounding property owners of the applicant’s intent to construct a permitted animal facility.

“Nuisance” means a condition causing annoyance or danger to a limited number of persons or to the general public as determined by the Department.

“Operator” means the person(s) who manage(s) a permitted animal facility and may be CAMM certified.

“Outstanding Recreational or Ecological Resource Waters (ORW)” means waters which are of exceptional recreational, ecological importance, or of unusual value. Such waters may include, but are not limited to: waters in national or state parks or wildlife refuges; waters supporting threatened or endangered species; waters under the National Wild and Scenic Rivers Act or South Carolina Scenic Rivers Act; waters known to be significant nursery areas for commercially important species or known to contain significant commercial or public shellfish resources; or waters used for or having significant value for scientific research and study.

“Owner” means the proprietor of any facility of activity subject to this regulation.

“Pasture” means land on which animals feed directly on feed crops including, but not limited to, legumes, grasses, grain stubble, or stover.

“Permit” means any license, certificate, registration, variance, or other approval issued by or required by the Department or any of its divisions, pursuant to any statute or regulation.

“Permit Extension” means a one (1)-year extension with justification that must be applied for in writing ten (10) calendar days prior to the permit expiration date.

“Permit Modification” means a minor or moderate change to a facility’s permit that is considered, as determined by the Department, to not change the general operations of the permitted site but is necessary to continue the regulated operation of the facility. Permit Modifications are not required to be Public Noticed.

“Permittee” means any person authorized to conduct any activity or business pursuant to a valid permit issued by or filed with the Department.

“Permitting Decision” means any decision by the Department to issue, modify, deny, or withdraw the permit.

“Person” means any individual, public or private corporation, political subdivision, association, partnership, corporation, municipality, state or federal agency, industry, co-partnership, firm, trust, estate, any other legal entity whatsoever, or an agent or employee thereof.

“Plant Available Nitrogen (PAN)” means the quantity of nitrogen made available during the growing season after fertilizing materials are applied. A certain amount of the nitrogen is immobilized, and the remaining nitrogen is available to the plant.

“Potable water well” means any well designed and/or constructed to produce potable water for consumption by humans or animals.

“Producer” means a person who grows or confines animals; a person responsible for the manure produced at an animal facility; a person processing manure; and/or a person responsible for the land application of manure.

“Production” means a facility that meets the permit requirements based on 30,000 pounds of Normal Production Animal Live Weight.

“Professional Engineer” or “Engineer” means a person who, by reason of his or her special knowledge of the mathematical and physical sciences and the principles and methods of engineering analysis and design, acquired by professional education and practical experience, is qualified to practice engineering, all as attested by his or her legal registration as a professional engineer in South Carolina.

“Public Hearing” means a proceeding, properly noticed in accordance with applicable state and federal laws, during which comments are received and testimony is taken to establish a record of concern prior to an administrative action by the Department.

“Public Notice” means the notice of an application or of proposed agency action published in accordance with applicable statutes and regulations.

“Range land” means open land with indigenous vegetation.

“Ranged Animal Facility” means the size of the range area is sufficient to allow for the natural degradation or utilization of the manure with no adverse impact to the environment. Ranged facilities shall also maintain adequate vegetative buffers between the animal range and the adjacent property lines and/or Waters of the State to mitigate runoff from reaching adjacent property and/or Waters of the State.

“Replacement in Kind” means construction of the same size or less of animal growing barn(s), and the same number or less of animal live weight, at the same location as the barn(s) being replaced.

“Residence” means a permanent inhabited dwelling, any existing church, school, hospital, or any other structure which is routinely occupied by the same person or persons more than twelve (12) hours per day or by the same person or persons under the age of eighteen (18) for more than two (2) hours per day, except those owned by the applicant.

“Rolling Average” means the laboratory results from the most recent analysis averaged with the previous manure analysis for a particular form of manure. The rolling average analysis sequence should be restarted after any major modification or changes to the lagoon/waste storage pond.

“Routinely” means a regular course of procedure.

“Runoff” means rainwater or other liquid that drains overland on any part of a land surface and runs off of the land surface.

“Seasonal High Water Table” means the surface between the zone of saturation and the zone of aeration, where the pore water pressure is equal to atmospheric pressure, and which exhibits the shallowest average water depth in relation to the surface during the wettest season.

“Small Animal Facility” means an animal facility (other than swine) that has a capacity for 500,000 pounds of normal production animal live weight or less at any one time.

“Small Swine Facility” means a swine facility with a capacity for 500,000 pounds of normal production animal live weight or less at any one time.

“Source Water Protection Area” means an area either above and/or below ground that is the source of water for a public drinking water system via a surface water intake or a water supply well that is designated by the State for increased protection.

“South Carolina National Heritage Corridor” means a National Heritage Area, federally designated in 1996, spanning seventeen (17) counties and 320 miles across South Carolina, and committed to promoting and preserving the cultural, natural, and historic resources of South Carolina.

“State” means South Carolina.

“Surface Water Runoff” means the flow of water that occurs when excess stormwater, meltwater, or other sources flows over the Earth’s surface.

“Swine” means a domesticated animal belonging to the porcine species.

“Swine by-product” means a secondary or incidental product of swine production that may include bedding, spilled feed, water or soil, hair, dead swine, or other debris. This definition may also refer to dead swine or swine manure compost.

“Swine facility” means an agricultural facility where swine are confined and fed or maintained for a total of forty-five (45) calendar days or more in a twelve (12)-month period and crops, vegetative, forage growth, or post-harvest residues are not sustained in the normal growing season over any portion of the lot or facility. Structures used for the storage of swine manure from swine in the operation are also part of the swine facility. Two or more swine facilities under common ownership or management are considered a single swine facility if they are adjacent or utilize a common system for swine manure treatment and/or storage. For any new or expanding swine facility, the combined normal production of all swine facilities owned by the producer, and of all swine facilities owned by corporations having a common majority shareholder in common with the producer, within 25 miles of the new or expanding facility shall be used to determine the normal production of the new or expanding facility. For example, when a new facility has a proposed capacity of 300,000 pounds of normal production and the producer owns two (2) other swine facilities within 25 miles of the new or expanding swine facility and the normal production of each facility is 400,000 pounds, the proposed swine facility’s normal production is 1,100,000 (300,000 + 400,000 + 400,000) pounds.

“Swine manure” means swine excreta or other commonly associated organic animal manures including, but not limited to, bedding, litter, feed losses, or water mixed with the manure.

“Vector” means a carrier that is capable of transmitting a pathogen from one organism to another including, but not limited to, flies and other insects, rodents, birds, and vermin.

“Waiver” means a document recording the deferral of a right, claim, or privilege.

“Waste Storage Pond” means an earthen waste impoundment that temporarily stores organic wastes such as manure and wastewater.

“Wastewater” means any water that, during the confinement of animals or the handling, storage, or treatment of manure, dead animals, and litter, comes into contact with the animals, manure, litter, or spilled feed. Wastewater includes, but is not limited to, wash waters, contaminated milk, and storm water (except storm water runoff from land application areas where the application of manure has been properly applied) that comes into contact with manure.

“Watershed” means a drainage area contributing to a river, lake, or stream.

“Waters of the State” means lakes, bays, sounds, ponds, impounding reservoirs, springs, artesian wells, rivers, perennial and navigable streams, creeks, estuaries, marshes, inlets, canals, the Atlantic Ocean within the territorial limits of the State, and all other bodies of water, natural or artificial, public or private, inland or coastal, fresh or salt, which are wholly or partially within or bordering the State or within its jurisdiction. This definition does not include ephemeral or intermittent streams. This definition includes wetlands as defined in this section.

“Wetlands” means lands that have a predominance of hydric soil, are inundated or saturated by water or groundwater at a frequency and duration sufficient to support a prevalence of hydrophytic vegetation typically adapted for life in saturated soil conditions, and, under normal circumstances, do support a prevalence of hydrophytic vegetation. Normal circumstances refer to the soil and hydrologic conditions that are normally present without regard to whether the vegetation has been removed. Wetlands shall be identified through the confirmation of the three wetlands criteria: hydric soil,

hydrology, and hydrophytic vegetation. All three criteria shall be met for an area to be identified as wetlands. Wetlands generally include swamps, marshes, and bogs.

“X-Large Animal Facility” means an animal facility (excluding swine) with 1,000,000 pounds or more of normal production animal live weight at any one time.

“X-Large Swine Facility” means a swine facility with 1,000,000 pounds or more of normal production animal live weight at any one time.

HISTORY: Amended by SCSR 45-5 Doc. No. 4997, eff May 28, 2021.

PART 100

SWINE FACILITIES

100.10. Purpose, Applicability, Inactive Facilities, and Facilities Permitted Prior to the Effective Date of the Regulation.

A. Purpose.

1. To establish standards for the growing or confining of swine, processing of swine manure and other swine by-products, and land application of swine manure and other swine by-products in such a manner as to protect the environment, and the health and welfare of citizens of the State from pollutants generated by this process.

2. To establish standards, which consist of general requirements, constituent limits, management practices, and operational standards, for the utilization of swine manure and other swine by-products generated at swine facilities. Standards included in this part are for swine manure and other swine by-products applied to the land.

3. To establish standards for the frequency of monitoring and record keeping requirements for producers who operate swine facilities.

4. To establish standards for the proper operation and maintenance of swine facilities.

5. To establish criteria for swine facilities' and manure utilization areas' location as they relate to protection of the environment and public health. The location of swine facilities and manure utilization areas as they relate to zoning in an area is not covered in this regulation. Local county or municipal governments may have zoning requirements and this regulation neither interferes with nor restricts such zoning requirements. Permit applicants should contact local municipal and county authorities to determine any local requirements that may be applicable.

B. Applicability.

1. This part applies to:

- a. All new swine facilities;
- b. All expansions of existing swine facilities;
- c. New manure utilization areas for existing swine facilities;
- d. All inactive facilities; and
- e. All facilities and lagoon closures.

2. This part applies to all swine manure and other swine by-products applied to the land.

3. This part applies to all land where swine manure and other swine by-products are applied.

C. Inactive Facilities.

1. If a swine facility is inactive for two (2) years or less, a producer may resume operations of the facility under the same conditions by which it was previously permitted by notifying the Department in writing that the facility is being operated again.

2. For swine facilities that have been inactive for more than two (2) years but less than five (5) years, the Department shall review the existing permit and modify its operating conditions as necessary prior to the facility being placed back into operation.

3. For swine facilities that have been inactive for more than five (5) years, the producer shall properly close out any lagoon, treatment system, or manure storage pond associated with the facility. The closeout shall be accomplished in accordance with R.61-82, Proper Closeout of Wastewater Treatment Facilities. The permittee shall submit a closeout plan that meets at a minimum NRCS-CPS

within a time frame prescribed by the Department. Additional time may be granted by the Department to comply with the closeout requirement or to allow a producer to apply for a new permit under this regulation, as appropriate.

4. If a swine facility is inactive for more than five (5) years, the permit is considered expired and the producer shall apply for a new permit. All requirements under this regulation shall be met before the facility can resume operations.

5. During the closeout of the facilities and/or lagoons/waste storage ponds, annual fees are required to be paid until proper closeout is certified and approved.

D. Facilities Permitted Prior to the Effective Date of the Regulation.

1. All existing swine facilities with permits issued by the Department before July 1, 1996, do not need to apply for a permit as they are deemed permitted swine facilities unless they have been inactive for more than two (2) years or expand operations. These facilities shall meet the following sections of Part 100: Section 100.20 (Permits and Compliance Period); Section 100.90 items A, G, and N-T (General Requirements for Lagoons, Treatment Systems, and Manure Storage Ponds); Section 100.100 (Manure Utilization Area Requirements); Section 100.110.G.-J. (Spray Application System Requirements); Section 100.120 A, C, and D (Frequency of Monitoring for Swine Manure); Section 100.130 A, B, C items 2-3 (Dead Swine Disposal Requirements); Section 100.140 A, C-J (Other Requirements); Section 100.150 B-G (Odor Control Requirements); Section 100.160 B-D (Vector Control Requirements); Section 100.170 (Record Keeping); Section 100.180 (Reporting); Section 100.190 A-F (Training Requirements); and Section 100.200 (Violations). The capacity of a deemed permitted facility is the maximum capacity of the existing lagoon, treatment system, or manure storage pond as determined using swine lagoon, treatment system, or manure storage pond capacity design standards of the United States Department of Agriculture's Natural Resource Conservation Service.

2. All existing swine facilities with permits issued by the Department between July 1, 1996, and the effective date of this regulation do not need to apply for a new permit if they hold a valid permit from the Department, unless they have been inactive for more than two (2) years. These facilities shall meet all the requirements of this regulation.

3. All existing swine facilities that were constructed and placed into operation prior to July 1, 1996, but have never received an agricultural permit from the Department, shall apply for a permit from the Department. These facilities shall meet all the requirements of this regulation, as the Department determines appropriate. The Department shall review the site and make a determination on a case-by-case basis on which requirements are applicable.

4. An existing facility may be required to submit for approval an updated Animal Facility Management Plan on a case-by-case basis by the Department. The Department shall notify the permittee in writing of this requirement. The permittee has six (6) months or an agreed upon time frame from the date of notification to submit an updated Animal Facility Management Plan. Failure to submit the updated plan within this time frame is a violation of the South Carolina Pollution Control Act and this regulation, and may result in permit revocation.

5. Both the setbacks and other requirements for manure utilization areas shall be met when a new manure utilization area (MUA) is added by the owner of any swine facility regardless of when the facility was permitted.

6. If an existing facility regulated under Part 200 of this regulation proposes to convert to a swine facility, it shall be considered a new swine facility under this regulation. Converted facilities shall be permitted as new swine facilities and meet all criteria for new swine facilities before they begin operation as a swine facility.

7. If an existing swine facility proposes to expand operations or increase the number of permitted swine such that it falls into a new size classification, the facility shall be considered a new swine facility in that size classification under this regulation. The facility shall meet all the requirements for the new classification.

100.20. Permits and Compliance Period.

A. Permit Requirement. Swine manure and other swine by-products from a new or expanded swine facility can only be generated, handled, stored, treated, processed, or land applied in the State in accordance with a permit issued by the Department under the provisions of this part. Existing producers that are required by the Department to update their Animal Facility Management Plan shall meet the requirements of this part to the extent practical as determined by the Department.

B. Permits issued under this regulation are no-discharge permits.

C. The requirements in this part shall be implemented through a permit issued to any producer who operates a swine facility where swine manure and other swine by-products are generated, handled, treated, stored, processed, or land applied.

D. The requirements under this part may be addressed in permits issued to producers who only land apply swine manure and other swine by-products.

E. Notification Requirements. The permittee shall notify the Department in writing and receive written Departmental approval, except as otherwise noted, prior to any change in operations at a permitted facility, including, but not limited to, the following:

1. Change in ownership and control of the facility. The Department has thirty (30) calendar days from the receipt of a complete and accurate notification of transfer of ownership to either: request additional information regarding the transfer or the new owner; deny the transfer; or approve the transfer. If the Department does not act within thirty (30) calendar days, the transfer is automatically approved. If additional information is requested by the Department in a timely manner, the Department shall act on this additional information, when it is received, within the same time period as the initial notification.

2. Increase in the permitted number of swine.

3. Increase in the normal production animal live weight of the existing permitted swine facility.

4. Addition of manure utilization areas.

5. Change in swine manure and other swine by-products treatment, handling, storage, processing, or utilization.

6. Change in method of dead swine disposal.

F. Permit modifications for items 100.20.E.3 and 100.20.E.5 for facilities regulated under this part, which shall result in expansions, shall adhere to the requirements of this part and other applicable statutes, regulations, or guidelines.

G. Permit modification for items 100.20.E.2–3 which result in an expansion may be required to obtain new written waivers or agreements for reduction of setbacks from adjoining property owners (if applicable).

HISTORY: Amended by SCSR 45–5 Doc. No. 4997, eff May 28, 2021.

100.30. Exclusions.

The following do not require permits from this part unless specifically required by the Department under Section 100.30.G.

A. Existing swine facilities that are deemed permitted under Section 100.10.D.1. are excluded from applying for a new permit unless an expansion is proposed, new manure utilization areas are added, or as required by the Department. New manure utilization areas added to an existing facility shall meet the appropriate requirements in this part. However, deemed permitted facilities shall meet the requirements of this regulation as outlined in Section 100.10.D (Purpose, Applicability, Inactive Facilities, and Facilities Permitted Prior to the Effective Date of the Regulation).

B. Except as given in Section 100.30.G, swine facilities that do not have a lagoon, manure storage pond, or liquid manure treatment system, having 10,000 pounds or less of normal production animal live weight at any one time, are excluded from obtaining a permit from the Department. However, these facilities shall have and implement an Animal Facility Management Plan for their facility that meets the requirements of this regulation.

C. Except as given in Section 100.30.G, swine facilities that do not have a lagoon, manure storage pond, or liquid manure treatment system, having more than 10,000 pounds of normal production

animal live weight at any one time and less than 30,000 pounds of normal production animal live weight at any one time, are excluded from obtaining a permit from the Department. However, these facilities shall submit an Animal Facility Management Plan to the Department and implement an Animal Facility Management Plan for their facility that meets the requirements of this regulation.

D. Except as given in Section 100.30.G, ranged swine facilities where the size of the range area is sufficient to allow for natural degradation or utilization of the swine manure with no adverse impact to the environment are excluded from obtaining a permit from the Department. Ranged facilities shall also maintain adequate vegetative buffers between the swine range and Waters of the State.

E. Except as given in Section 100.30.G, swine facilities that are not classified as swine for commercial purposes are excluded from obtaining a permit from the Department.

F. Except as given in Section 100.30.G, swine facilities that hold valid permits issued by the Department are not required to obtain a new permit if they decide to replace in kind any of the swine growing houses.

G. Swine facilities exempted under Sections 100.30.A, B, C, D, E, and F may be required by the Department to obtain a permit. The Department shall visit the site before requiring any of these facilities to obtain a permit.

HISTORY: Amended by SCSR 45-5 Doc. No. 4997, eff May 28, 2021.

100.40. Relationship to Other Regulations.

The following regulations are referenced throughout this part and may apply to facilities covered under this regulation.

A. Applications, application fees, and the time schedules governing the review of applications, and annual operating fees are addressed in R.61-30, Environmental Protection Fees.

B. The proper closeout of wastewater treatment facilities are addressed in R.61-82, Proper Closeout of Wastewater Treatment Facilities. This includes swine lagoons and manure storage ponds.

C. Setbacks and construction specifications for potable water wells and monitoring wells shall be in accordance with R.61-71, Well Standards.

D. Permits for air emissions from incinerators are addressed in R.61-62, Air Pollution Control Regulations and Standards.

E. Disposal of swine lagoon sludge in a municipal solid waste landfill unit is addressed in R.61-107.19, Solid Waste Management: Solid Waste Landfills and Structural Fill.

F. Disposal of swine manure with domestic or industrial sludge is addressed in R.61-9, Water Pollution Control Permits, and permitted under R.61-9.

G. Laboratory certification is addressed in R.61-81, State Environmental Laboratory Certification Program.

H. Water Classifications and Standards are addressed in R.61-68.

HISTORY: Amended by SCSR 45-5 Doc. No. 4997, eff May 28, 2021.

100.50. Permit Application Procedures (Animal Facility Management Plan Submission Requirements).

A. Preliminary Site Evaluations. The Department shall perform a preliminary evaluation of the proposed site at the request of the applicant. Written requests for a preliminary site inspection shall be made using a form provided by the Department. The Department shall not schedule a preliminary site inspection until all required information specified in the form has been submitted to the Department. This evaluation should be performed prior to preparation of the Animal Facility Management Plan. Once the preliminary site inspection is performed, the Department shall issue an approval or disapproval letter for the proposed site.

B. A producer who proposes to build a new swine facility or expand an existing swine facility shall make application for a permit under this part using an application form provided by the Department. The following information shall be included in the application package.

1. A completed and accurate application form.

2. An Animal Facility Management Plan prepared by qualified Natural Resources Conservation Service (NRCS) personnel or a S.C. registered professional engineer (PE). Other qualified individuals, such as certified soil scientists or S.C. registered professional geologists (PG), may prepare the land application component of an Animal Facility Management Plan. The Animal Facility Management Plan shall, at a minimum, contain:

- a. Facility name, address, telephone numbers, email address (if applicable), county, and National Pollutant Discharge Elimination System Permit or other permit number (if applicable);
- b. Facility location description and the zoning or land use restrictions in this area (this information is available from the county);
- c. Applicant's name, address, email, and telephone number (if different from above);
- d. Operator's name and CAMM number;
- e. Facility capacity;
 - i. Number of swine;
 - ii. Pounds of normal production animal live weight at any one time;
 - iii. Amount in gallons of swine manure generated per year;
 - iv. Description of swine manure storage and storage capacity of lagoon, treatment system, or manure storage pond (if applicable); and
 - v. Description of swine manure and other swine by-products treatment (if any).
- f. Concentration of constituents in swine manure including, but not limited to, the constituents given below:
 - i. Nutrients.
 - (a) Nitrate. (Only needed for aerobic treatment systems)
 - (b) Ammonium-Nitrogen.
 - (c) Total Kjeldahl Nitrogen (TKN).
 - (d) Organic Nitrogen (Organic Nitrogen = TKN - Ammonium Nitrogen)
 - (e) P_2O_5
 - (f) K_2O (potash).
 - ii. Constituents.
 - (a) Copper.
 - (b) Zinc.
 - iii. Name, address, S.C. lab certification number, and telephone number of the laboratory conducting the analyses.
 - iv. For new swine facilities, swine manure analysis information does not have to be initially submitted as the Department shall use swine manure analysis from similar sites or published data (such as: Clemson University, American Society of Agricultural Engineers, Midwest Planning Service Document, NRCS Technical Guide or equivalent) in the review of the application. Analysis of the actual swine manure generated shall be submitted to the Department six (6) months after a new swine facility starts operation or prior to the first application of swine manure to a manure utilization area, whichever occurs first. If this analysis is significantly different from the estimated analysis used in the permitting decision, the Department may require a permit modification as necessary to address the situation. Analysis shall be conducted by Clemson University Extension Service or a laboratory certified by the Department. This laboratory shall have and maintain certification for the constituents to be analyzed.
- g. Swine manure and other swine by-products handling and application information shall be included as follows:
 - i. A crop management plan which includes the time of year of the swine manure and other swine by-products application and how it relates to crop type, crop planting, and harvesting schedule (if applicable) for all manure utilization areas;

- ii. Name, address, email, and telephone number of the producer(s) that will land apply the swine manure and other swine by-products if different from the permittee;
 - iii. Type of equipment used to transport and/or spread the swine manure and other swine by-products (if applicable); and
 - iv. For spray application systems, plans and specifications with supporting details and design calculations for the spray application system.
- h. Facility and manure utilization area information shall be included (as appropriate):
- i. Name, address, and tax map number of landowner and location of manure utilization area(s);
 - ii. List previous calendar years that swine manure and/or dry manure and other swine by-products were applied and application amounts, where available;
 - iii. Facility and manure utilization area location(s) on maps drawn to approximate scale including:
 - (a) Topography (7.5' minutes or equivalent) and drainage characteristics (including ditches);
 - (b) Adjacent land usage (within 1/4 mile of property line minimum) and location of inhabited dwellings and public places showing property lines and tax map number;
 - (c) All known water supply wells on the applicant's property and within 500 feet of the facility's footprint of construction or within 200 feet of any manure utilization areas;
 - (d) Adjacent surface water bodies (including ephemeral and intermittent streams);
 - (e) Swine manure utilization area boundaries and buffer zones;
 - (f) right-of-ways (Utilities, roads, etc.);
 - (g) Soil types as given by soil tests or soil maps, a description of soil types, and boring locations (as applicable);
 - (h) Recorded plats, surveys, or other acceptable maps that include property boundaries; and
 - (i) Information showing the 100-year and 500-year floodplain as determined by FEMA.
 - iv. For manure utilization areas not owned by the permit applicant, a signed agreement between the permit applicant and the landowner acceptable to the Department detailing the liability for the land application. The agreement shall include, at a minimum, the following:
 - (a) Producer's name, farm name, farm address, CAMM number, and county in which the farm is located;
 - (b) Landowner's name, address, email, phone number;
 - (c) Location (map with road names, tax map numbers, and county identified) of the land to receive manure application;
 - (d) Field acreage, acreage less setbacks, and crops grown;
 - (e) Name of manure hauler;
 - (f) Name of manure applier;
 - (g) A statement that land is not included in any other management plans and manure or compost from another farm is not being applied on this land; and any manure utilization areas that are included in multiple Animal Facility Management Plans, identify the names of all facilities that include this manure utilization area in their plan; and
 - (h) A signed statement which informs the landowner that he is responsible for spreading and utilizing this manure in accordance with the requirements of the Department and this regulation.
3. Groundwater monitoring well details and proposed groundwater monitoring program (if applicable).

4. The Animal Facility Management Plan shall contain an odor abatement plan for the swine facility, lagoon, treatment system, manure storage pond, and manure utilization areas. For more specific details, see Section 100.150 (Odor Control Requirements).

5. A Vector Abatement Plan shall be included for the swine facility, lagoon, treatment system, manure storage pond, and manure utilization areas. For more specific details, see Section 100.160 (Vector Control Requirements).

6. The Dead Swine Disposal Plan shall include written details for the handling and disposal of dead swine. Plans should include method of disposal, any construction specifications necessary, and management practices. See Section 100.130 (Dead Swine Disposal Requirements) for more detailed information.

7. A Soil Monitoring Plan shall be developed for all manure utilization areas. See Section 100.100 (Manure Utilization Area Requirements) for more detailed information.

8. Plans and specifications for all other manure treatment or storage structures, such as holding tanks or manure storage sheds.

9. All "Notice of Intent to Build or Expand a Swine Facility" forms as provided by the Department and a tax map (or equivalent) to scale showing all neighboring property owners and identifying which property has inhabited dwellings that are required to be notified. See Section 100.60 (Public Notice Requirements) for more detailed information.

10. An Emergency Plan. The emergency plan shall, at a minimum, contain a list of entities or agencies the producer shall contact in the event of lagoon, treatment system, or manure storage pond breach, mass animal mortality, fire, flood, or other similar type problem. For facilities in the coastal areas of the State, the emergency plan shall address actions to be taken by a producer during hurricane season (such as providing additional freeboard during that time) and when advance warning is given on any extreme weather condition.

11. All waivers as specified in Section 100.80 (Facility, Lagoon, Treatment System, and Manure Storage Pond Siting Requirements), if applicable.

12. Application fee and the first year's operating fee as established by R.61-30.

C. The Department may request an applicant to provide any additional information deemed necessary to complete or correct deficiencies in the swine facility permit application prior to processing the application or issuing, modifying, or denying a permit.

D. Applicants shall submit all required information in a format acceptable to the Department.

E. An application package for a permit is complete when the Department receives all of the required information which has been completed to its satisfaction. Incomplete submittal packages may be returned to the applicant by the Department.

F. Application packages for permit modifications must contain the information applicable to the requested modification or any additional information the Department deems necessary.

HISTORY: Amended by SCSR 45-5 Doc. No. 4997, eff May 28, 2021.

100.60. Public Notice Requirements.

A. Small Swine Facilities.

1. For persons seeking to construct a new small swine facility, the applicant shall:

a. Notify all adjoining property owners and people residing on property within 1/4 mile (1,320 feet) of the proposed location of the facility (footprint of construction and manure storage pond) of the applicant's intent to build a swine facility.

b. Notify the parties listed in A.1.a. of this section using an NOI form provided by the Department. The NOI shall advise the adjoining property owners that they may send comments on the proposed animal facility directly to the Department.

2. For persons seeking to construct a new small swine facility or expand an established small swine facility, the Department shall post a Public Notice of application received, for fifteen (15) business days, on the Department's website. The Department may also post up to four (4) notices, in the four (4) cardinal directions around the perimeter of the property or in close proximity to the property, in visible locations as determined by the Department.

3. For small swine facilities, the Department shall review all comments received. If the Department receives twenty (20) or more letters from different people living in a 2-mile radius of the proposed facility requesting a meeting or the Department determines significant comment exists, a meeting shall be held to discuss and seek resolution to the concerns prior to a permit decision being made. All persons who have submitted written comments shall be invited in writing to the meeting. First Class US mail service, email, or hand delivery to the address of the interested party shall be used by the Department for the meeting invitation. However, if the Department determines that the number of persons who submitted written comments is significant, the Department shall publish a notice of the public meeting in a local newspaper of general circulation instead of notifying each individual by First Class mail. In addition, the Department shall notify all group leaders and petition organizers in writing or email. Agreement of the parties is not required for the Department to make a permit decision.

B. Large Swine Facilities.

1. For persons seeking to construct a new large swine facility or expand an established large swine facility, the applicant shall:

a. Notify all adjoining property owners and people residing on property within 1/4 mile (1,320 feet) of the proposed location of the facility (footprint of construction and manure storage pond) of the applicant's intent to build a swine facility.

b. Notify the parties listed in B.1.a. of this section using an NOI form provided by the Department. The NOI shall advise the adjoining property owners that they may send comments on the proposed animal facility directly to the Department.

2. For persons seeking to construct a new large swine facility or expand an established large swine facility, the Department shall:

a. Post a Public Notice of application received, for fifteen (15) business days, on the Department's website. The Department may also post up to four (4) notices, in the four (4) cardinal directions around the perimeter of the property or in close proximity to the property, in visible locations as determined by the Department;

b. Notify the appropriate county commission;

c. Notify the appropriate water supply district (owners or operators of any potable surface water treatment plant located downstream from the proposed swine facility that could reasonably be expected to be adversely impacted if a significant problem arose); and

d. Notify any person who asked to be notified.

3. First Class US mail service, email, or hand delivery to the address of a person to be notified shall be used by the Department for the notifications in Section 100.60.B.2.b-d. If the Department determines that members of the same group or organization have submitted comments or a petition, the Department shall only notify all groups, organization leaders, and petition organizers in writing or email. The Department shall ask these leaders and organizers to notify their groups or any concerned citizens who signed the petitions.

4. The notice shall contain instructions for public review and comment to the Department on the proposed construction and operation of the swine facility. The notice shall allow for a minimum fifteen (15) business-day comment period.

5. If the Department receives twenty (20) or more letters or emails from different people living in a 2-mile radius of the proposed facility requesting a public meeting or the Department determines there is significant public interest, the Department shall conduct a public meeting and shall provide notice of the public meeting in accordance with the notice requirements provided for in Section 100.60.B.2.a-d. The initial public notice and meeting notice can be combined into one (1) notice.

C. Additional requirements for X-large swine facilities.

1. For persons seeking to construct a new X-large swine facility or expand an established X-large swine facility, the applicant shall notify all property owners and person(s) residing on property within one mile (5,280 feet) of the proposed location of the X-large swine facility (footprint of construction and manure storage pond) by certified mail. The notification must include the following information:

a. Name and address of the person proposing to construct an X-large swine facility;

- b. The type of swine facility, the design capacity, and a description of the proposed swine manure management system;
- c. The name and address of the preparer of the Animal Facility Management Plan;
- d. The address of the local Natural Resources Conservation Service (NRCS) office; and
- e. A statement, approved by the Department, informing the adjoining property owners and property owners within 1 mile of the proposed facility, that they may submit written comments or questions to the Department.

2. The applicant shall conduct a minimum of one public meeting to present to the public the proposed project, its purpose, design, and environmental impacts. The applicant shall provide at least thirty (30) calendar days notice of the meeting date and time by advertisement in a local newspaper of general circulation in the area of the proposed facility. The public meeting notice can be combined into one (1) notice in combination with the notice run by the Department. However, the applicant must provide information concerning the date, time, and location of the public meeting at the time of application. The minutes of the public meeting, proof of advertisement, and opinions derived from the meeting must be submitted to the Department.

3. The Department shall conduct a public meeting and shall provide notice of the public meeting in accordance with the notice requirements provided for in Section 100.60.B.2.a-d. The initial public notice and meeting notice can be combined into one (1) notice. The Department shall provide at least thirty (30) calendar days notice of the meeting.

D. For properties that have multiple owners or properties that are in an estate with multiple heirs, the applicant shall send an NOI to construct an animal facility by certified mail to each individual. This notice shall serve as notice to these multiple property owners of the applicant's intent to build a swine facility.

E. When comments are received by email, the Department shall acknowledge receipt of the comment by email. These comments shall be handled in the same manner as written comments received by postal mail.

F. The Department shall consider all relevant comments received in determining a final permit decision.

G. The Department shall send notice of the permit decision to issue or deny the permit to the applicant, all persons who commented in writing to the Department, and all persons who attended the public meeting, if held. First Class US mail service, email, or hand delivery to the address of a person to be notified shall be used by the Department for the decision notification. However, if the Department determines that members of the same group or organization have submitted comments or a petition, the Department shall only notify all group leaders and petition organizers in writing or email. The Department shall ask these leaders and organizers to notify members of their groups or any concerned citizens who signed the petitions.

H. For permit issuances, the Department shall publish a notice of issuance of a permit to construct or expand a swine facility on the Department's website.

I. For permit denials, the Department shall give the permit applicant a written explanation which outlines the specific reasons for the permit denial.

J. For permit denials, the Department may publish a notice of decision on the Department's website.

K. The Department shall include, at a minimum, the following information in the public notices: the name and location of the facility, a description of the operation and the method of manure and other swine by-products handling, instructions on how to appeal the Department's decision, the time frame for filing an appeal, the date of the decision, and the date upon which the permit becomes effective.

HISTORY: Amended by SCSR 45-5 Doc. No. 4997, eff May 28, 2021.

100.70. Permit Decision Making Process.

- A. No permit shall be issued before the Department receives a complete application package.

B. The agricultural program of the Department is not involved in local zoning and land use planning. Local government(s) may have more stringent requirements for agricultural animal facilities. The permittee is responsible for contacting the appropriate local government(s) to ensure that the proposed facility meets all the local requirements.

C. After the Department has received a complete application package, a technical review shall be conducted by the Department. The Department may request any additional information or clarification from the applicant or the preparer of the Animal Facility Management Plan to help with the determination on whether a permit should be issued or denied. If a permit application package meets all applicable requirements of this part, a permit may be issued.

D. A preliminary site inspection shall be made by the Department before a complete application package is received by the Department.

E. The Department shall consider the cumulative impacts including, but not limited to, impacts from evaporation; storm water; and other potential and actual point and nonpoint sources of pollution runoff; levels of nutrients or other elements in the soils and nearby waterways; groundwater or aquifer contamination; pathogens or other elements; and the pollution assimilative capacity of the receiving waterbody. These cumulative impacts will be considered prior to permitting new or expanded swine facilities. Alternative manure and other swine by-products treatment and utilization methods may be required in watersheds which are nutrient-sensitive waters, or impaired by pathogens.

F. The Department shall act on all permits to prevent, as far as reasonably possible considering relevant standards under state and federal laws, an increase in pollution of the waters and air of the State from any new or enlarged sources.

G. The Department also shall act on all permits so as to prevent degradation of water quality due to the cumulative and secondary effects of permit decisions. Cumulative and secondary effects are impacts attributable to the collective effects of a number of swine facilities in a defined area and include the effects of additional projects similar to the requested permit proposed on sites in the vicinity. All permit decisions shall ensure that the swine facility and manure treatment and utilization alternative with the least adverse impact on the environment will be utilized. To accomplish this, new and expanding facilities, except X-large swine facilities, shall use the best available technology economically achievable for the handling, storage, processing, treatment, and utilization of manure. New and expanding X-large swine facilities shall use the best available technology for the handling, storage, processing, treatment, and utilization of manure. Cumulative and secondary effects shall include, but are not limited to, runoff from land application of swine manure and a swine facility; evaporation and atmospheric deposition of elements; ground-water or aquifer contamination; the buildup of elements in the soil; and other potential and actual point and nonpoint sources of pollution in the vicinity.

H. The setback limits given in Part 100 are siting requirements. The Department shall evaluate the following factors to determine if any special conditions are necessary:

1. Latitude and Longitude;
2. Down-wind receptors; and
3. Nutrient Management Plan.

I. When a permit is issued it shall contain an issue date, an effective date, and, when applicable, a construction expiration date. The effective date shall be at least fifteen (15) calendar days after the issue date to allow for any appeals. If a timely appeal is not received, the permit shall be effective on the effective date.

J. The swine facility, lagoon, treatment system, or manure storage pond can be built only when the permit is effective. The facility cannot be placed into operation until the Department grants a written Approval to Operate (ATO).

K. To receive an ATO, the producer shall have the preparer of the Animal Facility Management Plan submit in writing, to the Department, the following information:

1. Certification that the construction of the structural components (such as the facility footprint, the lagoon, treatment system and/or manure storage pond) has been completed in accordance with the approved Animal Facility Management Plan and the requirements of this regulation;
2. Certification that no portion of the facility has been constructed in the 100-year floodplain;
3. Certification for containment of structural failures, if applicable; and

4. Certification for lagoon or manure storage pond lining, if applicable.

L. The Department shall conduct a final inspection before granting approval to a producer to begin operations.

M. The Department shall grant written approval for the producer to begin operations after it has received the information in 100.70.K and the satisfactory results of a final inspection.

N. Swine Facility Permit Construction Expiration and Extensions.

1. Construction permits issued by the Department for agricultural animal facilities shall be given two (2) years from the effective date of the permit to start construction and three (3) years from the effective date of the permit to complete construction.

2. If the proposed construction as outlined in the permit is not started prior to the construction start expiration date, the construction permit is invalid unless an extension in accordance with this regulation is granted.

3. If construction is not completed and the facility is not placed into operation prior to the construction completion expiration date, the construction permit is invalid unless an extension in accordance with this regulation is granted.

4. If only a portion of the permitted facility (animal growing houses and associated manure treatment and/or storage structures are completely constructed, but not all houses originally permitted were constructed) is completed prior to the construction completion expiration date, the construction for the remainder of the permit may be utilized within the permit life. The permittee shall obtain Departmental approval prior to utilizing the permit in this manner. The Department may require that the permittee submit additional information or update the Animal Facility Management Plan prior to approval.

5. Extensions of the construction permit start and completion dates may be granted by the Department. The permittee shall submit a written request explaining the delay and detailing any changes to the proposed construction. This request shall be received no later than the expiration date that the permittee proposes to extend. The maximum extension period shall not exceed one (1) year. There shall be no more than two (2), one (1)-year extension periods per permit to construct, granted.

O. Permits issued under this regulation for all swine facilities shall be renewed at least every seven (7) years.

P. An expired permit (final expiration date for renewal) issued under this part continues in effect until a new permit is effective if the permittee submits a complete application, to the satisfaction of the Department, at least one hundred eighty (180) calendar days before the existing permit expires. The Department may grant permission to submit an application later than the deadline for submission stated above, but no later than the permit expiration date. If the facility has been closed for any two (2) consecutive years since the last permit was issued, the provision for the expiring permit remaining in effect does not apply since the permit is no longer valid. Permittees shall notify the Department in writing within thirty (30) calendar days before going out of business.

Q. Permit renewal applications shall meet all the requirements of this regulation as the Department determines appropriate. The Department shall review the site and make a determination on a case-by-case basis on which requirements are applicable.

R. No permit will be issued to an applicant who contracts with an integrator or integrating company unless the permit is in accordance with the approved cumulative environmental and public health impact assessment plan as required in part 500.20 (Submittal Requirements) of this regulation.

HISTORY: Amended by SCSR 45-5 Doc. No. 4997, eff May 28, 2021.

100.80. Swine Facility, Lagoon, Treatment System, and Manure Storage Pond Siting Requirements.

A. Siting Requirements applicable to all small swine facilities and the lagoons, treatment systems, and/or manure storage ponds associated with them.

1. The minimum separation distance between a swine facility (not including a lagoon, treatment system, manure storage pond, or manure utilization area) and a potable water well (excluding the applicant's well) is 200 feet. The minimum separation distance between a swine facility (not including

a lagoon, treatment system, manure storage pond, or manure utilization area) and a potable water well owned by the applicant is 50 feet (as required by R.61–71).

2. The minimum separation distance between a lagoon, treatment system, or a manure storage pond and a public or private human drinking water well (excluding the applicant's well) is 500 feet. The minimum separation distance between a lagoon, treatment system, or manure storage pond and a potable water well owned by the applicant is 100 feet.

3. Except for site drainage, the minimum separation distance required between a ditch or swale, which drains directly into Waters of the State (including ephemeral and intermittent streams) and a swine facility, swine lagoon, treatment system, or manure storage pond is 100 feet.

4. The minimum separation distance required between a swine facility, lagoon, treatment system, or manure storage pond and ephemeral or intermittent streams is 100 feet.

5. The minimum separation distance required between a small swine facility (not including the lagoon, treatment system, or manure storage pond) and Waters of the State (excluding ephemeral and intermittent streams) is 100 feet.

6. The minimum separation distance required between a small swine lagoon, treatment system, or manure storage pond and Waters of the State (excluding ephemeral and intermittent streams) is 500 feet.

7. If the Waters of the State (not including ephemeral and intermittent streams) are designated Outstanding Resource Waters, Critical Habitat Waters of federally endangered species, or Shellfish Harvesting Waters, the minimum separation distance required between a small swine lagoon, treatment system, or a manure storage pond and Waters of the State (not including ephemeral and intermittent streams) is 1,320 feet (1/4 mile).

8. For small swine facilities the separation distance required between a swine growing area (pens or barns not including range areas) and the lot line of real property owned by another person is 400 feet and 1,000 feet from the nearest residence.

9. For small swine facilities the separation distance required between a lagoon, treatment system, or manure storage pond and the lot line of real property owned by another person is 600 feet and 1,000 feet from the nearest residence.

10. The distances in items 8 and 9 above can be reduced by written consent of the adjoining property owner, unless a swine facility is located on the adjacent property or within 1,000 feet of the property line. Written consent is not needed when the Department reduces the distances under the requirements of Part 300.

B. Siting Requirements applicable to all large swine facilities, and the lagoons, treatment systems, and manure storage ponds associated with the facility.

1. The minimum separation distance between a large swine facility (not including a lagoon, treatment system, manure storage pond, or manure utilization area) and a potable water well (excluding the applicant's well) is 200 feet. The minimum separation distance between a swine facility (not including a lagoon, treatment system, manure storage pond, or manure utilization area) and a potable water well owned by the applicant is 50 feet (as required by R.61–71).

2. The minimum separation distance between a lagoon, treatment system, or a manure storage pond, and a public or private human drinking water well (excluding the applicant's well) is 500 feet. The minimum separation distance between a lagoon, treatment system, or manure storage pond and a potable water well owned by the applicant is 100 feet.

3. Except for site drainage, the minimum separation distance required between a ditch or swale, which drains directly into Waters of the State (including ephemeral and intermittent streams) and a swine facility, swine lagoon, treatment system, or manure storage pond associated with a large swine facility is 100 feet.

4. The minimum separation distance required between a large swine facility, lagoon, treatment system, or manure storage pond, associated with the facility and ephemeral or intermittent streams is 200 feet.

5. The minimum separation distance required between a large swine facility (not including the lagoon, treatment system, or manure storage pond) and Waters of the State (including ephemeral and intermittent streams) is 200 feet.

6. The minimum separation distance required between a large swine lagoon, treatment system, or manure storage pond and Waters of the State (not including ephemeral and intermittent streams) is 1,320 feet (1/4 mile). If the Waters of the State (not including ephemeral and intermittent streams) are designated Outstanding Resource Waters, Critical Habitat Waters of federally endangered species, or Shellfish Harvesting Waters, the minimum separation distance required between a lagoon, treatment system, or manure storage pond and Waters of the State (not including ephemeral and intermittent streams) is 2,640 feet (1/2 mile). A minimum 100-foot wide vegetative water quality buffer of plants and trees is required to be installed and maintained on the site between the facility and any down slope Waters of the State. Sites with existing vegetation may qualify to utilize the existing vegetation for a buffer, if the vegetation is deemed sufficient. For new facilities constructed in areas where natural vegetation is not present, the Department shall evaluate these sites on a case-by-case basis to determine the amount of vegetative buffer that shall be planted. However, each site shall be required at a minimum to provide a vegetative buffer that meets the current NRCS standards.

7. The minimum separation distance required between a large swine facility (growing area, pens or barns not including range areas) and real property owned by another person is 1,000 feet.

8. For large swine facilities, the minimum separation distance required between a lagoon, treatment system, or a manure storage pond and real property owned by another person is 1,250 feet.

9. The minimum separation distance required between large swine facilities is 2 miles.

10. A separation distance to adjacent land as provided in items 7 and 8 above does not apply to a swine facility, lagoon, treatment system, or manure storage pond which is constructed or expanded, if the titleholder of adjoining land to the concentrated swine operation executes a written waiver with the title holder of the land where the swine facility is established or proposed to be located, under terms and conditions that the parties negotiate. The written waiver becomes effective only upon the recording of the waiver in the office of the Register of Deeds of the county in which the benefited land is located. The filed waiver precludes enforcement of 100.80.B.7 and 8 as it relates to the swine facility and to real property owned by another person. The permittee shall submit a copy of the document with the recording stamp to the Department. The separation distances shall not be reduced or waived if a swine facility is located on the adjacent property or within 1,000 feet of the property line.

C. Siting requirements applicable to X-large swine facilities and the lagoons, treatment systems, and manure storage ponds associated with the facility are as follows:

1. The minimum separation distance required between an X-large swine facility and Waters of the State (including ephemeral and intermittent streams) is 2,640 feet (1/2 mile).

2. The minimum separation distance required between an X-large swine lagoon, treatment system, or manure storage pond and Waters of the State (including ephemeral and intermittent streams) is 2,640 feet (1/2 mile). If the Waters of the State (not including ephemeral and intermittent streams) are designated Outstanding Resource Waters, Critical Habitat Waters of federally endangered species, or Shellfish Harvesting Waters, the minimum separation distance required between a lagoon, treatment system, or manure storage pond and Waters of the State (not including ephemeral and intermittent streams) is 3,960 feet (3/4 mile). A minimum 100-foot wide vegetative water quality buffer of plants and trees is required to be installed and maintained on the site between the facility and any down slope Waters of the State. Sites with existing vegetation may qualify to utilize the existing vegetation for a buffer, if the vegetation is deemed sufficient. For new facilities constructed in areas where natural vegetation is not present, the Department shall evaluate these sites on a case-by-case basis to determine the amount of vegetative buffer that shall be planted. However, each site shall be required, at a minimum, to provide a vegetative buffer that meets the current NRCS standards.

3. The minimum separation distance required between an X-large swine facility (including the lagoon, treatment system, and manure storage pond) and real property owned by another person or a residence (excluding the applicant's residence) is 1,750 feet.

4. The minimum separation distance between an X-large swine facility (including a lagoon, treatment system, or manure storage pond) and a potable water well (excluding the applicant's well)

is 1,750 feet. The minimum separation distance between a swine facility (including a lagoon, treatment system, or manure storage pond) and a potable water well owned by the applicant is 100 feet (as required by R.61-71).

5. The minimum separation distance required between X-large swine facilities is 25 miles.

D. A new swine facility or an expansion of an established swine facility may not be located in the 100-year floodplain.

E. Water (a pond) that is completely surrounded by land owned by the permit applicant and has no connection to other water is excluded from the setback requirements outlined in this part.

F. All lagoon and manure storage pond setbacks contained in this part shall be measured from the outside toe of the dike.

G. Setback limits given in this part are minimum siting requirements, except those not labeled as minimum requirements, which are absolutes. On a case-by-case basis the Department may require additional separation distances to the minimum setbacks applicable to swine facilities. See Section 100.70.H. for specific criteria evaluated for determining if greater setbacks should be required.

HISTORY: Amended by SCSR 45-5 Doc. No. 4997, eff May 28, 2021.

100.90. General Requirements for Swine Manure Lagoons, Treatment Systems, and Swine Manure Storage Ponds.

A. The lagoon, treatment system, or manure storage pond shall be designed by a professional engineer or an NRCS engineer and the construction shall be certified by the design engineer or professional engineer licensed in S.C. It is a violation of this regulation and the South Carolina Pollution Control Act for the owner or operator of the facility to make modifications or physical changes to the lagoon, treatment system, or manure storage pond without the prior approval of the Department and supervision of NRCS or a professional engineer. Plans and specifications for lagoon, treatment system, or manure storage pond modifications shall be designed and certified by NRCS or a professional engineer and submitted to the Department for approval prior to the modification.

B. Swine manure lagoons and manure storage ponds shall be designed at a minimum to NRCS-CPS. The lagoon or manure storage pond shall be designed to provide a minimum storage capacity for manure, wastewater, normal precipitation less evaporation, normal runoff, and residual solids accumulation for the twenty-five (25) year - twenty-four (24) hour storm event (precipitation and associated runoff) and at least one and one half (1 ½) feet of freeboard. New X-large swine facilities shall be designed to provide storage capacity for all the above-mentioned items, including the fifty (50) year - twenty-four (24) hour storm event (precipitation and associated runoff) and at least 2 feet of freeboard.

C. All lagoons and storage ponds constructed or expanded after the date of this regulation shall be provided with a geomembrane liner, designed with an initial specific discharge rate of less than 0.0156 feet/day in order to protect groundwater quality. Lagoons and manure storage ponds at X-large swine facilities within delineated source water protection areas or vulnerable recharge areas, as determined by the Department, shall be lined with a geomembrane liner such that the vertical hydraulic conductivity does not exceed 5×10^{-7} cm/sec. Geomembrane liners, at a minimum, shall meet NRCS-CPS. For existing lagoons or manure storage ponds lined using only soils with low permeability rates (e.g., clay), the Department shall require appropriate documentation to demonstrate that the computed soil permeability of the liner is sufficient to prevent seepage greater than the initial specific discharge rate. Appropriate certification shall be provided by the preparer of the Animal Facility Management Plan that the NRCS-CPS for lining lagoons and/or manure storage ponds with soils have been met.

D. Lagoons and manure storage ponds at swine facilities shall not exceed one million cubic feet of total volume, unless the lagoon or manure storage pond implements a design to control the discharge from a failed lagoon, treatment system, or manure storage pond so that it never enters Waters of the State.

E. Large swine facilities are prohibited from utilizing open anaerobic lagoons or manure storage ponds. These facilities shall utilize best available technology that is economically achievable for the manure handling, treatment, storage, and utilization.

F. X-Large swine facilities are prohibited from utilizing open lagoons or manure storage ponds. These facilities shall utilize best available technology for the manure handling, treatment, storage, and

utilization. Lagoons and manure storage ponds utilized at X-large swine facilities shall be designed with airtight covers. Air pollution control devices utilizing the Best Available Technology shall be installed on all lagoon cover vents and openings to remove ammonia, hydrogen sulfide, methane, formaldehyde, and any other organic and inorganic air pollutants, which may be required by the Department. Such air pollution control devices shall meet all the requirements of the Department and appropriate air quality permits shall be obtained. "Best Available Technology" means, for the air emissions purpose of this regulation, the rate of emissions which reflects the most stringent emissions limitations required by any State regulation or permit, existing at the time the application is made, for all pollutants emitted from this source category; or, the most stringent emissions limit achieved in actual practice, whichever is more stringent.

G. If seepage results in either an adverse impact to groundwater or a significant adverse trend in groundwater quality occurs, as determined by the Department, the lagoon or manure storage pond shall be repaired at the owner's or operator's expense. Assessment and/or additional monitoring (more wells, additional constituents, and/or increased sampling frequency) may be required by the Department to determine the extent of the seepage. The repairs and/or assessment shall be completed in accordance with an implementation schedule approved by the Department. The Department may require groundwater corrective action.

H. Manure and other swine by-products shall not be placed directly in or allowed to come into contact with groundwater and/or surface water. The minimum separation distance between the lowest point of the lagoon and/or manure storage pond and the seasonal high water table beneath the lagoon and/or manure storage pond is 2 feet. If a geomembrane liner is installed, then the minimum separation distance is 1 foot from the seasonal high water table. Designs that include controlled drainage for water table adjustment shall be evaluated by the Department on a case-by-case basis, and may include additional monitoring and groundwater control requirements. If a design is proposed for water table adjustment, the design shall not impact wetlands. Groundwater monitoring wells may be required to be installed and monitored at a frequency as given in the permit for the facility in situations where a liner is used to allow the lowest point of a lagoon to be less than 2 feet to the seasonal high water table.

I. Owners of lagoons and manure storage ponds at large and X-large swine facilities shall be required to install at least one (1) up-gradient and two (2) down-gradient monitoring wells at a depth which the Department considers appropriate around the lagoon or series of lagoons in order to monitor groundwater quality. For small swine facilities, the Department may require monitoring wells upon Department review of the submittal package.

J. A groundwater monitoring plan shall be submitted with the permit application to the Department. All applicable State certification requirements regarding well installation, laboratory analyses, and report preparation shall be met. Groundwater monitoring wells shall be sampled at least once annually by qualified personnel, at the expense of the permittee. Monitoring wells at X-large swine facilities must be sampled at least quarterly, unless more frequent sampling is specified in the permit. The results shall be submitted to the Department in accordance with the specified permit requirements. Groundwater monitoring results shall be maintained by the producer for eight (8) years. The Department may conduct routine and random visits to the swine facility to sample the monitoring wells.

K. The monitoring wells shall be properly installed and sampled prior to use of the lagoon or manure storage pond. All monitoring wells shall be sampled in accordance with the parameters identified in the permit such that a background concentration level can be established.

L. Before the construction of a lagoon and/or a manure storage pond, the owner or operator shall remove all under-drains that exist from previous agricultural operations that are under the lagoon or manure storage pond and/or within 25 feet of the outside toe of the proposed lagoon or manure storage pond dike. This requirement does not include under-drains that are approved as a part of a design that includes controlled drainage for water table adjustment.

M. Lagoons and manure storage ponds at X-large swine facilities shall install automated lagoon level monitoring devices.

N. Proper water levels in lagoons and manure storage ponds, as per plans and specifications, shall be maintained at all times by the permittee. The Department may require specific lagoon or manure

storage pond volume requirements in permits. An approved marker shall be installed to measure waste levels.

O. If a lagoon, treatment system, or manure storage pond, or all of these, breaches or fails, the owner or operator of the swine facility shall immediately notify the Department, the appropriate local government officials, and the owners or operators of any potable surface water treatment plant located downstream from the swine facility that could reasonably be expected to be adversely impacted.

P. Lagoons, treatment systems, and manure storage ponds shall be completely enclosed with an acceptable fence, unless a fence waiver is obtained from the Department.

Q. Lagoons and manure storage ponds shall have at least four (4) warning signs posted in the four (4) cardinal directions around the perimeter of the structure. These signs must read, "Warning - Deep and Polluted Water".

R. Vegetation on the dikes and around the lagoon or manure storage pond should be kept below a maximum height of 18 inches. Trees or deeply rooted plants shall be prevented from growing on the dikes or within 25 feet of the outside toe of the dikes of the lagoon, treatment systems, or manure storage pond. Existing trees on the dikes shall be evaluated by NRCS staff or a dam engineer licensed in South Carolina to determine if they should be removed or remain.

S. Livestock or other animals that could cause erosion or damage to the dikes of the lagoon or manure storage pond shall not be allowed to enter the lagoon or manure storage pond, or graze on the dike or within 25 feet of the outside toe of the dike.

T. The Department shall require existing facilities, regardless of size, with a history of manure handling, treatment, and disposal problems related to a lagoon, to phase out the existing lagoon and incorporate new technology.

HISTORY: Amended by SCSR 45-5 Doc. No. 4997, eff May 28, 2021.

100.100. Manure Utilization Area Requirements.

A. Application Rates. The Department shall approve an Animal Facility Management Plan that establishes an application rate for each manure utilization area based on the agronomic application rate of the specific crop(s) being grown. Other factors considered are the manure and other swine by-products' impact on the environment, animals, and people living in the vicinity. The application rate shall also be based on the limiting constituent (either a nutrient or other constituent as given in item 100.100.B). In developing annual constituent loading rates and cumulative constituent loading rates, the Department shall consider:

1. Soil type;
2. Type of vegetation growing in land-applied area;
3. Proximity to 100-year floodplain;
4. Location in watershed;
5. Nutrient sensitivity of receiving land and waters;
6. Soil nutrient testing in conjunction with soil productivity information;
7. Nutrient, copper, zinc, and constituent content of the manure and other swine by-products being applied;
8. State Approved Source Water Protection Area;
9. Proximity to other point and nonpoint sources;
10. Slope of land (anything over ten percent (10%) must use runoff best management practices, runoff controls, or conservation features as per NRCS);
11. Distance to water table or groundwater aquifer;
12. Timing of manure application to coincide with vegetative cover growth cycle;
13. Timing of harvest of vegetative cover;
14. Hydraulic loading limitations;
15. Soil assimilative capacity;
16. Type of vegetative cover and its nutrient uptake ability;

- 17. Method of land application; and
- 18. Aquifer vulnerability.

B. Constituent Limits for Land Application of Swine manure and other swine by-products.

1. The Department may establish constituent limits in permits on a case-by-case basis on swine manure and other swine by-products to be land applied. Swine manure and other swine by-products containing only the standard constituents at normal concentrations as given by commonly accepted reference sources, such as Clemson University, American Society of Agricultural Engineers, Midwest Planning Service Document, or NRCS, can be land applied at or below agronomic rates without any specific constituent limits in a permit. When the swine manure or other swine by-products analysis indicates there are levels of copper, or other constituents of concern, the Department shall establish constituent limits in permits for each constituent of concern to ensure the water quality standards of R.61-68 are maintained. For these cases, the producer shall comply with the following criteria:

- a. Constituent Limits. If swine manure and other swine by-products subject to a constituent limit is applied to land, either:
 - i. the cumulative loading rate for each constituent shall not exceed the rates in Table 1 of Section 100.100; or
 - ii. the concentration of each constituent in the swine manure and other swine by-products shall not exceed the concentrations in Table 2 of Section 100.100.
- b. Constituent concentrations and loading rates - swine manure.
 - i. Cumulative constituent loading rates.

TABLE 1 OF SECTION 100.100 - CUMULATIVE CONSTITUENT LOADING RATES		
Cumulative Constituent Loading Rate		
Constituent	(kilograms per hectare)	(pounds per acre)
Copper	1500	1339
Zinc	2800	2499

- ii. Constituent concentrations.

TABLE 2 OF SECTION 100.100 - CONSTITUENT CONCENTRATIONS	
Monthly Average Concentrations	
Constituent	Dry weight basis (milligrams per kilogram)
Copper	1500
Zinc	2800

- iii. Annual constituent loading rates.

TABLE 3 OF SECTION 100.100 - ANNUAL CONSTITUENT LOADING RATES		
Annual Constituent Loading Rate		
Constituent	(kilograms per hectare per 365-day period)	(pounds per acre per 365-day period)
Copper	75	67
Zinc	140	125

c. Additional constituent limits may be required, from the application information or subsequent monitoring in a permit thereafter, but such needs shall be assessed on an individual project basis.

d. Swine manure and other swine by-products shall not be applied subject to the cumulative constituent loading rates in Table 1 of Section 100.100.B.1 to land if any of the rates in Table 1 of Section 100.100.B.1 have been reached unless the constituent is removed from the manure and other swine by-products.

e. Swine manure and other swine by-products shall not be applied to land during a 365-day period after the annual application rate in Table 3 of Section 100.100.B.1 has been reached.

f. If swine manure and other swine by-products subject to the cumulative constituent loading rates in Table 1 of Section 100.100.B.1 have not been applied to the site, then the cumulative rates apply.

g. If swine manure and other swine by-products subject to the cumulative constituent loading rates in Table 1 of Section 100.100.B.1 have been applied to the site and the cumulative amount of each constituent is known, the cumulative amount of each constituent applied to the site shall be used to determine the additional amount of each constituent that can be applied to the site in accordance with Section 100.100.B.1.a.i (cumulative loading rate shall not exceed the cumulative constituent loading rate).

h. Manure application shall not exceed the agronomic rate of application for plant available nitrogen (PAN) for the intended crop(s) on an annual basis. For those years that fertilizer is land applied, manure in combination with the fertilizer shall not exceed the agronomic rate of nutrient utilization of the intended crop(s).

2. Any producer who confines swine shall ensure that the applicable requirements in this part are met when the swine manure and other swine by-products are applied to the land.

3. Swine manure and other swine by-products shall not be applied to land that is saturated from recent precipitation, flooded, frozen, or snow-covered. Swine manure and other swine by-products shall not be applied during inclement weather or when a significant rain event is forecasted to occur within forty-eight (48) hours, unless approved by the Department in an emergency situation.

4. Swine manure and other swine by-products shall not be placed directly in groundwater.

5. All land application equipment, (e.g. Spreader, injection) when used once or more per year, shall be calibrated at least annually by the person land applying. A permit may require more frequent calibrations to ensure proper application rates. The two (2) most recent calibration records should be retained by the producer and made available for Department review upon request. If the land application equipment has not been used in over a year, the equipment shall be calibrated prior to use.

6. Swine manure and other swine by-products shall not be applied to the land except in accordance with the requirements in this part.

7. A producer who supplies swine manure and other swine by-products to another person for land application shall provide the person who will land apply the manure and other swine by-products with the concentration of plant available nitrogen, phosphorus, potassium, and the concentration of all other constituents listed in the permit. The producer shall also supply the person who will land apply the manure with a copy of the crop management plan included in their Animal Facility Management Plan.

8. Swine manure and other swine by-products shall not be applied to or discharged onto a land surface when the vertical separation between the ground surface and the seasonal high water table is less than 1.5 feet at the time of application, unless approved by the Department on a case-by-case basis. For special cases, no land application can occur when the vertical separation from the ground surface to the water table is less than 1.5 feet at the time of application unless a situation is deemed an emergency with departmental concurrence.

9. Soil sampling (usually 6–8 inch depth) shall be conducted for each field prior to manure application to determine the appropriate application rate. Each field should be sampled at least once per year. If manure application frequency shall be less than once per year, then at least one (1) soil sample shall be taken prior to returning to that field for land application. All new manure utilization areas shall be evaluated using the NRCS-CPS to determine the suitability for application and the limiting nutrient (nitrogen or phosphorus). However, fields that are high in phosphorus may also be required to incorporate additional runoff control or soil conservation features as directed by the Department.

10. Soil sampling to a depth of 18 inches may be required by the Department within forty-five (45) calendar days after each application of swine manure, but no more than two (2) times per year if the application frequency is more than twice per year. This sampling shall be performed for at least

three (3) years after the initial application on at least one (1) representative manure utilization area for each crop grown to verify the estimated calculated swine manure application rates for the utilization areas. The date of manure application and the date of sampling shall be carefully recorded. The sampling shall be conducted at depths of 0 to 6 inches, 6 to 12 inches, and 12 to 18 inches with nitrates and phosphorus being analyzed.

11. The results of the pre-application and post-application sampling shall be used by the crop farmer to adjust as necessary, the amount of swine manure to be applied to a manure utilization area to meet the agronomic application rate for the crop(s) to be grown. These results shall be submitted to the Department at the time of application for permit renewal.

12. Additional soil sampling to greater depths may be required by the Department on a case-by-case basis to ensure there is no potential for groundwater contamination.

13. The permittee shall obtain the following information needed to comply with the requirements in this part:

a. A manure transfer contract shall be developed for the producer to use with any person who is accepting manure in quantities greater than 12 tons per recipient per year. The contract should contain, at a minimum, the following information:

i. Name, address, county and telephone number of the person who is purchasing or accepting animal manure and other animal by-products;

ii. Manure nutrient composition (pounds per ton of plant available nitrogen, phosphorus, and potassium) to be filled in or provided by the producer. This information shall be obtained from the manure analysis results and the producer shall provide this information on the manure transfer contract.

iii. Land application field information;

iv. Physical description (acreage, crop, soil type);

v. Soil test results (phosphorus, zinc, and copper in pounds/acre); and

vi. Recommended application rates (nitrogen, phosphorus, and potassium in pounds/acre as reported on a soil test).

b. Attach a copy of a soils map, topographic map, county tax map, plat, FSA map, or a site plan sketch that includes the following information:

i. Manure application area with setbacks outlined;

ii. Known water supply wells within 100 feet of the property line;

iii. Adjacent surface waters, including ditches, streams, creeks, and ponds; and

iv. Identification of roads and highways to indicate location.

c. Description of application equipment and name of person to land apply manure;

d. Signed agreement that informs the landowner that he or she is responsible and liable for land applying the animal manure and other animal by-products in accordance with this regulation; and

e. A copy of the land application requirements shall be provided to the recipient of the manure.

14. All persons who routinely accept manure from a producer, in quantities greater than 12 tons per recipient per year, shall be listed in the approved Animal Facility Management Plan. The Animal Facility Management Plan shall include the appropriate manure utilization area information for the sites routinely used by other persons. The producer shall inform the applier of their responsibility and have a signed manure transfer contract to properly manage the land application of manure to prevent discharge of pollutants to Waters of the State (including ephemeral and intermittent streams). The person accepting the manure may be required by the Department to have an Animal Facility Management Plan and a permit for his or her manure utilization areas.

15. All persons who accept manure from a producer, in quantities less than 12 tons per recipient per year are responsible for land applying the manure in accordance with these requirements and must have a signed agreement with the producer explaining their responsibility to comply with this

regulation. The Department may require the persons(s) land applying the manure to correct any problems that result from the application of manure.

16. Swine manure shall not be applied to cropland more than thirty (30) calendar days before planting or during dormant periods for perennial species, unless otherwise approved by the Department in an emergency situation.

17. When the Department receives nuisance complaints on a land application site, the Department may restrict land application of animal manure on this site completely or during certain time periods.

18. The Department may require manure to be disked in immediately.

19. Manure (solid or liquid) shall only be applied when weather and soil conditions are favorable and when prevailing winds are blowing away from nearby dwellings. Animal manure should not be applied to land when the soil is saturated, flooded, during rain events, or when a significant rain event is forecasted to occur within forty-eight (48) hours, unless otherwise approved by the Department in an emergency situation.

20. Manure shall not be spread in the floodplain if there is danger of a major runoff event, unless the manure is incorporated during application or immediately after application.

21. If the manure is stockpiled outside, the manure shall be stored on a concrete pad or other approved pad (such as plastic or clay lined) and covered on a daily basis (unless otherwise specified in the permit) with an acceptable cover to prevent odors, vector attraction, and runoff. The cover should be vented properly with screen wire to let the gases escape. The edges of the cover should be properly anchored.

22. If a producer, who contracts to transfer the swine manure and other swine by-products produced at his or her facility, changes brokers, he or she must submit notification and a new broker contract for approval to the Department.

23. The body of vehicles transporting manure shall be wholly enclosed and, while in transit, be kept covered with a canvas cover provided with eyelets and rope tie-downs, or any other approved method that shall prevent blowing or spillage of loose material or liquids. Should any spillage occur during the transportation of the manure, the owner/operator shall take immediate steps to clean up the manure.

C. Setbacks for manure utilization areas (MUA) for small, large, and X-large swine facilities.

1. Siting Requirements applicable to all manure utilization areas associated with all swine facilities.

a. The minimum separation distance required between a manure utilization area and a residence is 300 feet. If there are no residences within 300 feet of the manure utilization area, manure can be applied up to the property line. The 300-foot setback may be waived with the consent of the owner of the residence. If the application method is injection or immediate (same day) incorporation, manure may be applied up to the property line. The setbacks are imposed at the time of application. The Department may impose these setbacks on previously approved sites to address problems on a case-by-case basis.

b. The minimum separation distance required between a manure utilization area and Waters of the State (not including ephemeral and intermittent streams), ditches, and swales that drain directly into Waters of the State (not including ephemeral and intermittent streams) is 100 feet.

c. The minimum separation distance required between a manure utilization area and ephemeral and intermittent streams is 100 feet when spray application is the application method, 75 feet when incorporation is the application method, and 50 feet when injection is the application method. When incorporation is accomplished within twenty-four (24) hours of the initial application, the distance can be reduced to 50 feet.

d. The minimum separation distance required between a manure utilization area and ditches and swales that drain directly into ephemeral and intermittent streams is 50 feet.

e. The minimum separation distance required between a manure utilization area and a potable drinking water well is 200 feet.

2. Water (pond) that is completely surrounded by land owned by the applicant and has no connection to surface water is excluded from the setback requirements outlined in this part.

3. The Department may establish in permits additional application buffer setbacks for property boundaries, roadways, residential developments, dwellings, water wells, drainage ways, and surface water (including ephemeral and intermittent streams) as deemed necessary to protect public health and the environment. Factors taken into consideration in the establishment of additional setbacks would be swine manure application method, adjacent land usage, public access, aerosols, runoff prevention, adjacent groundwater usage, aquifer vulnerability, and potential for vectors and odors.

D. The Department may establish additional permitting restrictions based upon soil and groundwater conditions to ensure protection of the groundwater and surface Waters of the State (including ephemeral and intermittent streams). Criteria may include, but is not limited to, soil permeability, clay content, depth to bedrock, rock outcroppings, aquifer vulnerability, proximity to State Approved Source Water Protection Area, and depth to the seasonal high groundwater table.

E. The Department may establish permit conditions to require that swine manure and other swine by-products application rates remain consistent with the lime and fertilizer requirements for the cover, feed, food, and fiber crops based on Southeastern land grant universities' published lime and fertilizer recommendations (such as the Lime and Fertilizer Recommendations, Clemson Extension Services).

F. Groundwater Monitoring for Manure Utilization Areas.

1. For X-large swine facilities, at least one (1) up-gradient and two (2) down-gradient groundwater monitoring wells shall be installed for each drainage basin intersected by the manure utilization areas. The location, design, and construction specifications for the monitoring wells shall be submitted in the application package. The information shall be reviewed and approved by the Department prior to permit issuance. The permit will contain specific requirements for sampling the groundwater monitoring wells, including the frequency and parameters for sampling.

2. For small and large swine facilities, the Department may require groundwater monitoring at manure utilization areas as appropriate.

3. The Department may establish minimum requirements in permits for soil and/or groundwater monitoring for manure utilization areas. Factors taken into consideration in the establishment of soil and groundwater monitoring shall include groundwater depth, operation flexibility, application frequency, type of swine manure and other swine by-products, size of manure utilization area, aquifer vulnerability, proximity to a State Approved Source Water Protection Area, and loading rate.

a. The Department may establish pre-application and post-application site monitoring requirements in permits for limiting nutrients or limiting constituents as determined by the Department.

b. The Department may establish permit conditions, which require the permittee to reduce, modify, or eliminate the swine manure and other swine by-products applications based on the results of this monitoring data.

c. The Department may modify, revoke and reissue, or revoke a permit based on the monitoring data.

G. The Department may require periodic monitoring of any wet weather ditches or perennial streams which are in close proximity to any manure utilization areas.

HISTORY: Amended by SCSR 45-5 Doc. No. 4997, eff May 28, 2021.

100.110. Spray Application System Requirements.

A. Spray application of swine manure using irrigation equipment. This includes all methods of surface spray application, including, but not limited to, fixed gun application, traveling or mobile gun application, or center pivot application.

B. New X-large swine facilities are prohibited from utilizing spray application systems for manure application. Manure must be incorporated into the manure utilization fields using subsurface injection at a depth of not less than 6 inches.

C. Manure utilization area slopes shall not exceed ten percent (10%) unless approved by the Department. The Department may require that slopes be less than ten percent (10%) based on site conditions.

D. Swine manure distribution systems shall be designed so that the distribution pattern optimizes uniform application.

E. Hydraulic Application Rates.

1. Application rates shall normally be based on the agronomic rate for the crop to be grown at the manure utilization area. As determined by soil conditions, the hydraulic application rate may be reduced below the agronomic rate to ensure no surface ponding, runoff, or excessive nutrient migration to the groundwater occurs.

2. The hydraulic application rate may be limited based on constituent loading including any constituent required for monitoring under this regulation.

F. Swine manure and other swine by-products shall not be applied when the vertical separation between the ground surface and the seasonal high water table is less than 1.5 feet at the time of application, unless approved by the Department on a case-by-case basis. For special cases, no land application can occur when the vertical separation from the ground surface to the water table is less than 1.5 feet at the time of application unless a situation is deemed an emergency with Departmental concurrence.

G. Conservation measures, such as terracing, strip cropping, etc., may be required in specific areas determined by the Department as necessary to prevent potential surface runoff from entering or leaving the manure utilization areas. The Department may consider alternate methods of runoff controls that may be proposed by the applicant, such as berms.

H. For swine facilities, a system for monitoring the quality of groundwater may also be required for the proposed manure utilization areas. The location of all the monitoring wells shall be approved by the Department. The number of wells, constituents to be monitored, and the frequency of monitoring shall be determined on a case-by-case basis based upon the site conditions such as type of soils, depth of water table, aquifer vulnerability, proximity to State Approved Source Water Protection Area, etc.

I. If an adverse trend in groundwater quality is identified, further assessment and/or corrective action may be required. This may include an alteration to the permitted application rate or a cessation of manure application in the impacted area.

J. Spray application systems shall be designed and operated in such a manner to prevent drift of liquid manure onto adjacent property.

HISTORY: Amended by SCSR 45-5 Doc. No. 4997, eff May 28, 2021.

100.120. Frequency of Monitoring for Swine Manure.

A. The producer and/or integrator shall be responsible for having representative samples based on Clemson University Extension Service recommendations of the swine manure collected and analyzed at least once per year and when the feed composition significantly changes. The constituents to be monitored shall be given in the permit. The analyses shall be used to determine the amount of swine manure to be land applied. In order to ensure that the permitted application rate (normally the agronomic rate) is met, the application amount shall be determined using a rolling average of the previous analyses. The Department shall establish minimum requirements for the proper method of sampling and analyzing of swine manure. Facilities with permits that do not specify which constituents to monitor shall monitor for ammonium-nitrogen, Total Kjeldahl Nitrogen (TKN), organic nitrogen (organic nitrogen = TKN - ammonium nitrogen), P_2O_5 , and K_2O .

B. The Department may require nitrogen, potassium, phosphorus, the constituents listed in Table 1 and Table 2 of Section 100.100 (Manure Utilization Area Requirements), and any other constituent contained in a permit to be monitored prior to each application.

C. Permittees do not have to analyze for any constituent they can demonstrate, to the satisfaction of the Department, is not present in their swine manure.

D. All monitoring shall be done in accordance with collection procedures in Standard Methods for Analysis of Water and Wastewater or other Department guidelines. Analysis shall be conducted by Clemson University Extension Service or a laboratory certified by the Department. This laboratory shall have and maintain certification for the constituents to be analyzed.

HISTORY: Amended by SCSR 45-5 Doc. No. 4997, eff May 28, 2021.

100.130. Dead Swine Disposal Requirements.

A. Dead swine disposal shall be done as specified in the approved Animal Facility Management Plan. The Dead Swine Disposal Plan shall include the following:

1. Primary Method for the handling and disposal of normal mortality on the farm.
2. Alternate Method for the handling and disposal of excessive mortality at the facility. The normal method of disposal may not be sufficient to handle an excessive mortality situation. Each producer shall have a Department-approved emergency or alternate method to dispose of excessive mortality. Excessive mortality burial sites shall be preapproved by the Department prior to utilization.

B. Burial.

1. Burial pits may be utilized for emergency conditions, as determined by the Department, when the primary method of disposal is not sufficient to handle excessive mortality.
2. Burial pits shall not be located in the 100-year floodplain.
3. Soil type shall be evaluated for leaching potential.
4. Burial pits shall not be located or utilized on sites that are in areas that may adversely impact surface or groundwater quality or further impact impaired water bodies.
5. The bottom of the burial pit may not be within 2 feet of the seasonal high groundwater table.
6. No burial site shall be allowed to flood with surface water.
7. Swine placed in a burial site shall be covered daily with sufficient cover (6 inches per day minimum) to prohibit exhumation by feral animals.
8. When full, the burial site shall be properly capped (minimum 2 feet) and grassed to prohibit erosion.
9. Proposed burial pit sites shall be approved by the Department. The Department may conduct a geologic review of the proposed site prior to approval.
10. The Department may require any new or existing producers to utilize another method of dead swine disposal if burial is not managed according to the Dead Swine Disposal Plan or repeated violations of these burial requirements occur or adverse impact to surface or groundwater is determined to exist.

11. The Department may require groundwater monitoring for dead animal burial pits on a case-by-case basis. The Department shall consider all of the facts including, but not limited to, the following: depth to the seasonal high water table; aquifer vulnerability; proximity to a State Approved Source Water Protection Area; groundwater use in the area; distance to adjacent surface waters; number of dead animals buried; and frequency of burial in the area.

C. Incinerators.

1. For facilities proposing an incinerator for dead swine disposal, either a permit for the air emissions shall be obtained from the Department's Bureau of Air Quality before the incinerator can be built or the following criteria shall be met in order to qualify for an exemption from an air permit:
 - a. The emission of particulate matter shall be less than 1 pound per hour at the maximum rated capacity.
 - b. The incinerator shall be a package incinerator that meets the requirements from the Department's Bureau of Air Quality; and
 - c. The incinerator shall not exceed an opacity limit of ten percent (10%).
2. Incinerators used for dead swine disposal shall be properly operated and maintained. Operation shall be as specified in the owner's manual provided with the incinerator. The owner's manual shall be kept on site and made available to Department personnel upon request.
3. The use of the incinerator to dispose of waste oil, hazardous waste, or any other waste chemical is prohibited. The use of the incinerator shall be limited to dead swine disposal only unless otherwise approved by the Department's Bureau of Air Quality.

D. Composters used for dead swine disposal shall be designed by a professional engineer or an NRCS representative and operated in accordance with the approved Animal Facility Management Plan. Packaged composters shall be approved on a case-by-case basis.

E. Disposal of dead swine in a municipal solid waste landfill shall be in accordance with R.61-107.19.

F. Disposal of swine carcasses or body parts into manure lagoons, treatment systems, storage ponds, Waters of the State, ephemeral and intermittent streams, ditches, and swales is prohibited.

G. Disposal of animal carcasses or body parts by rendering shall be approved by the Department and include a signed contract with the rendering company.

H. Other methods of dead animal disposal that are not addressed in this regulation may be proposed in the Dead Animal Disposal Plan.

HISTORY: Amended by SCSR 45-5 Doc. No. 4997, eff May 28, 2021.

100.140. Other Requirements.

A. There shall be no discharge of pollutants from the operation into surface Waters of the State (including ephemeral and intermittent streams). There shall be no discharge of pollutants into groundwater, which could cause groundwater quality not to comply with the groundwater standards established in R.61-68.

B. On a case-by-case basis, the Department may impose additional or more stringent requirements for the management, handling, treatment, storage, or utilization of swine manure and other swine by-products.

C. The following cases shall be evaluated for additional or more stringent requirements:

1. Source water protection. Facilities and manure utilization areas located within a State-approved source water protection area.

2. 303(d) Impaired Water Bodies List. Facilities and manure utilization areas located upstream of an impaired waterbody.

3. Proximity to Outstanding Resource Waters, trout waters, shellfish waters, or potential to adversely affect a federally listed endangered or threatened species, its habitat, or a proposed or designated critical habitat.

4. Aquifer Vulnerability Area is an area where groundwater recharge may affect an aquifer.

D. If an adverse impact to the Waters of the State, including ephemeral and intermittent streams, or groundwater from swine manure and other swine by-products handling, storage, treatment, or utilization practices are documented, through monitoring levels exceeding the standards set forth in R.61-68 or a significant adverse trend occurs, the Department may require the producer responsible for the swine manure and other swine by-products to conduct an investigation to determine the extent of impact. The Department may require the producer to remediate the water to within acceptable levels as set forth in R.61-68.

E. No manure may be released from a swine manure lagoon, treatment system, or storage pond or the premises of a swine facility to Waters of the State, including ephemeral and intermittent streams.

F. Swine medical waste cannot be disposed into swine lagoons, treatment systems, or manure storage ponds, or land applied with swine manure and other swine by-products.

G. In the event of a discharge from a swine lagoon, treatment system, or manure storage pond, the permittee is required to notify the Department immediately, within twenty-four (24) hours of the discharge.

H. When the Department determines that a nuisance exists at a swine facility, the permittee shall take action to correct the nuisance to the degree and within the time frame designated by the Department.

I. Permittees shall maintain all-weather access roads to their facilities at all times.

HISTORY: Amended by SCSR 45-5 Doc. No. 4997, eff May 28, 2021.

100.150. Odor Control Requirements.

A. The Animal Facility Management Plan shall contain an odor abatement plan for the swine facility, lagoon, treatment system, manure storage pond, and manure utilization areas. The plan shall consist of the following:

1. Operation and maintenance practices which are used to eliminate or minimize undesirable odor levels in the form of a Best Management Plan for Odor Control;
2. Use of treatment processes for the reduction of undesirable odor levels;
3. Additional setbacks from property lines beyond the minimum setbacks given in this part;
4. Other methods as may be appropriate; or
5. Any combination of these methods.

B. Producers shall utilize Best Management Practices normally associated with the proper operation and maintenance of a swine facility, lagoon, treatment system, manure storage pond, and any manure utilization area to ensure an undesirable level of odor does not exist.

C. No producer may cause, allow, or permit emission into the ambient air of any substance or combination of substances in quantities that an undesirable level of odor is determined to result unless preventive measures of the type set out below are taken to abate or control the emission to the satisfaction of the Department. When an odor problem comes to the attention of the Department through field surveillance or specific complaints, the Department shall determine if the odor is undesirable.

D. If the Department determines an undesirable level of odor exists, the Department may require these abatement or control practices, including, but not limited to, the following:

1. Remove or dispose of odorous materials;
2. Methods in handling and storage of odorous materials that minimize emissions;
 - a. Dry to a moisture content of fifty percent (50%) or less;
 - b. Solids separation from liquid manure, and composting of solids;
 - c. Use disinfection to kill microorganisms present in manure;
 - d. Aerate manure;
 - e. Anaerobic digestion in a sealed vessel;
 - f. Compost solid manure and other swine by-products;
 - g. Utilize odor control additives.
3. Prescribed standards in the maintenance of premises to reduce odorous emissions;
 - a. Filtration (biofilters or other filter used to remove dust and odor) of ventilation air;
 - b. Keep animals clean and separate from manure;
 - c. Adjust number of animals confined in the pens or paddocks in accordance with Clemson University Animal Space Guidelines;
 - d. Frequent removal of manure from animal houses;
 - e. Add a layer of water in the shallow pits after the manure is removed;
 - f. Feeding areas should be kept dry, and waste feed accumulation should be minimized;
 - g. Maintain feedlot surfaces in a dry condition (twenty-five to forty percent (25 to 40% moisture content), with effective dust control;
 - h. Proper maintenance of the dead swine disposal system;
 - i. Cover or reduce the surface area of manure and other swine by-products storage. (Vents shall be provided for release of pressure created by manure gases if completely sealed covers are used);
 - j. Plant trees around or downwind of the manure and other swine by-products storage and treatment facilities (trees shall not be planted within 25 feet of the toe of the dike);
 - k. Incorporate manure and other swine by-products immediately after land application; and
 - l. Select appropriate times for land application.

4. Best Available Technology to reduce odorous emissions.

E. Nothing in this section prohibits an individual or group of persons from bringing a complaint against a swine facility, including problems at lagoons, treatment systems, manure storage ponds, and manure utilization areas.

F. If the permittee fails to control or abate the odor problems at a swine facility, lagoon, treatment system, manure storage pond, and any manure utilization area to the satisfaction and within a time frame determined by the Department, the permit may be revoked. If the permittee fails to control or abate the odor problems at land application sites, approval for land application of manure on the manure utilization area in question may be revoked. Additional land may be required to be added to the Animal Facility Management Plan, if necessary, to provide a sufficient amount of land for manure utilization.

HISTORY: Amended by SCSR 45-5 Doc. No. 4997, eff May 28, 2021.

100.160. Vector Control Requirements.

A. The Vector Abatement Plan shall, at a minimum, consist of the following:

1. Best management practices used at the swine facility, lagoon, treatment system, manure storage pond, and manure utilization areas to ensure there is no accumulation of organic or inorganic materials to the extent and in such a manner as to create a harborage for rodents or other vectors that may be dangerous to public health.

2. A list of specific actions to be taken by the producer if vectors are identified as a problem at the swine facility, lagoon, treatment system, manure storage pond, or any manure utilization area. These actions should be listed for each vector problem, e.g., actions to be taken for fly problems, actions to be taken for rodent problems, etc.

B. No producer may cause, allow, or permit vectors to breed or accumulate in quantities that result in a nuisance level, as determined by the Department.

C. For an existing facility, if the Department determines a vector problem exists, the Department may require these abatement or control practices, including, but not limited to, the following:

1. Remove and properly dispose of vector infested materials;
2. Methods in handling and storage of materials that minimize vector attraction;
 - a. Remove spilled or spoiled feed from the house as soon as practicably possible, not to exceed forty-eight (48) hours, unless otherwise approved by the Department;
 - b. Remove and properly dispose of dead animals as soon as practicably possible, not to exceed twenty-four (24) hours, unless otherwise approved by the Department;
 - c. Increase the frequency of manure removal from animal houses;
 - d. Prevent solids buildup in the pit storage or on the floors or walkways;
 - e. Remove excess manure packs along walls and curtains;
 - f. Compost solid manure and other swine by-products;
 - g. Appropriate use of vector control chemicals, poisons, or insecticides (take caution to prevent insecticide resistance problems);
 - h. Utilize traps, or electrically charged devices;
 - i. Utilize biological agents;
 - j. Utilize Integrated Pest Management; and
 - k. Incorporate manure and other swine by-products immediately (within twenty-four (24) hours) after land application.
3. Prescribed standards in the maintenance of premises to reduce vector attraction;
 - a. Remove standing water that may be a breeding area for vectors;
 - b. Keep animals clean or separated from manure;
 - c. Keep facility clean and free from trash or debris;
 - d. Properly utilize and service bait stations;

- e. Keep feeding areas dry, and minimize waste feed accumulation;
 - f. Keep grass and weeds mowed around the facility and manure storage or treatment areas;
 - g. Maintain the dead swine disposal system;
 - h. Cover or reduce the surface area of manure and other swine by-products storage. (Vents shall be provided for release of pressure created by manure gases if completely sealed covers are used);
 - i. Properly store feed and feed supplements;
 - j. Conduct a weekly vector monitoring program;
 - k. Be aware of insecticide resistance problems, and rotate use of different insecticides;
 - l. Prevent and repair leaks in waterers, water troughs or cups; and
 - m. Ensure proper grading and drainage around the buildings to prevent rain water from entering the buildings or ponding around the buildings.
4. Utilize the best available control technology to reduce vector attraction and breeding.

HISTORY: Amended by SCSR 45-5 Doc. No. 4997, eff May 28, 2021.

100.170. Record Keeping.

A. A copy of the approved Animal Facility Management Plan, including approved updates, and a copy of the permit(s) issued to the producer shall be retained by the permittee for as long as the swine facility is in operation.

B. All application information submitted to the Department shall be retained by the permittee for eight (8) years. However, if the facility was permitted prior to June 26, 1998, and the permittee has previously discarded these documents since there was no requirement to maintain records at that time, this requirement shall not apply.

C. Records shall be developed for each manure utilization area. These records shall be kept for eight (8) years. The records shall include the following:

- 1. For each time swine manure and other swine by-products are applied to the site, the amount of swine manure and other swine by-products applied (in gallons per acre or pounds per acre, as appropriate), the date and time of the application, and the location of the application;
- 2. All sampling results for swine manure that is land applied;
- 3. All soil monitoring results;
- 4. All groundwater monitoring results, if applicable; and
- 5. Crops grown.

D. Records for the facility to include the following on a monthly basis:

- 1. Animal count and the normal production animal live weight; and
- 2. Mortality count and method of disposal.

E. Records for lagoon, treatment system, or manure storage pond operations to include the following:

- 1. Monthly water levels of the lagoon, treatment system, and manure storage pond; and
- 2. Groundwater monitoring results, if applicable.

F. All records retained by the producer shall be kept at either the facility, an appropriate business office, or other location as approved by the Department.

G. All records retained by the producer shall be made available to the Department during normal business hours for review and copying, upon request by the Department.

HISTORY: Amended by SCSR 45-5 Doc. No. 4997, eff May 28, 2021.

100.180. Reporting.

A. All large and X-large swine operations shall submit, on a form approved by the Department, the following on an annual basis or more frequently if required by a permit or regulation:

1. All manure sampling results for the last year, if applicable, and the latest rolling average concentration for the land limiting constituent;
 2. All soil monitoring results, if applicable;
 3. All groundwater monitoring results, if applicable;
 4. Calculated application rates for all manure utilization areas; and
 5. The adjusted application rates, if applicable, based on the most recent swine manure sampling, soil samples, and crop yields. The application rate change could also be due to a change in field use, crop grown, or other factors.
- B. The Department may require small swine facilities to submit annual reports on a case-by-case basis.
- C. The Department may establish permit conditions to require a swine facility to complete and submit a comprehensive report every five (5) years. The Department shall review this report to confirm that the permitted nutrient application rates have not been exceeded. Based on the results of the review, additional soil and/or groundwater monitoring requirements, permit modification, and/or corrective action may be required.

HISTORY: Amended by SCSR 45-5 Doc. No. 4997, eff May 28, 2021.

100.190. Training Requirements.

- A. An owner/operator of a new or existing swine facility, lagoon, manure storage pond, or manure utilization area shall complete a training program on the operation of swine manure management created by Clemson University, i.e. (CAMM).
- B. Owners/Operators of new and existing swine facilities shall be required to pass a test and become certified as a part of the training program created by Clemson University.
- C. The certification shall be completed by owners/operators of new facilities prior to start-up of operations.
- D. The certification shall be completed by owners/operators of existing facilities within two (2) years of the effective date of this regulation. The certification program shall be completed by owners/operators involved in a transfer of ownership within one (1) year of the transfer of ownership approval.
- E. The certification shall be maintained as long as the facility remains in operation.
- F. Failure to obtain the certification as provided in this Section shall be deemed a violation of this regulation.
- G. Additional Training and Certification Requirements for X-Large Swine Facilities:
1. The Department shall classify all manure treatment systems serving X-large swine facilities, giving due regard to size, types of work, character, and volume of manure to be treated, and the use and nature of the land resources receiving the manure.
 2. Manure treatment systems may be classified in a group higher than indicated at the discretion of the Department by reason of the following:
 - a. Incorporation in the treatment system of complex features which cause the treatment system to be more difficult to operate than usual; or
 - b. A waste stream that is unusually difficult to treat; or
 - c. Conditions of flow; or
 - d. Use of the receiving lands requiring an unusually high degree of system operation control; or
 - e. Combinations of such conditions or circumstances.
 3. The classifications for biological treatment systems are based on the following groups:
 - a. Group I - B. All agricultural manure treatment systems which include one (1) or more of the following units: primary settling, chlorination, sludge removal, Imhoff tanks, sand filters, sludge drying beds, land spraying, grinding, screening, oxidation, and stabilization ponds.

b. Group II - B. All agricultural manure treatment systems which include one (1) or more of the units listed in Group I-B and, in addition, one (1) or more of the following units: sludge digestion, aerated lagoon, and sludge thickeners.

c. Group III - B. All agricultural manure treatment systems which include one (1) or more of the units listed in Groups I-B and II-B and, in addition, one (1) or more of the following: trickling filters, secondary settling, chemical treatment, vacuum filters, sludge elutriation, sludge incinerator, wet oxidation process, contact aeration, and activated sludge (either conventional, modified, or high rate processes).

d. Group IV - B. All agricultural manure treatment systems which include one (1) or more of the units listed in Groups I-B, II-B, and III-B and, in addition, treat manure having a raw five (5)-day biochemical oxygen demand of 5,000 pounds per day or more.

4. The classifications for physical chemical manure treatment systems are based on the following groups:

a. Group I-P/C. All agricultural manure treatment systems which include one (1) or more of the following units: primary settling, equalization, pH control, and oil skimming.

b. Group II-P/C. All agricultural manure treatment systems which include one (1) or more of the units listed in Group I-P/C and, in addition, one (1) or more of the following units: sludge storage, dissolved air flotation, and clarification.

c. Group III-P/C. All agricultural manure treatment systems which include one (1) or more of the units listed in Groups I-P/C and II-P/C and, in addition, one (1) or more of the following: oxidation/reduction reactions, cyanide destruction, metals precipitation, sludge dewatering, and air stripping.

d. Group IV-P/C. All agricultural manure treatment systems which include one (1) or more of the units listed in Groups I-P/C, II-P/C, and III-P/C and, in addition, one (1) or more of the following: membrane technology, ion exchange, tertiary chemicals, and electrochemistry.

5. It shall be unlawful for any person or corporation to operate an agricultural manure treatment system at an X-large swine facility unless the operator-in-charge holds a valid certificate of registration issued by the Board of Certification of Environmental Systems Operators in a grade corresponding to the classification of the agricultural manure treatment system supervised by him or her.

HISTORY: Amended by SCSR 45-5 Doc. No. 4997, eff May 28, 2021.

100.200. Violations.

A. Persons who violate this regulation or any permit issued under this regulation are subject to the penalties in Sections 48-1-320 (Criminal Penalties) and 48-1-330 (Civil Penalties) of the South Carolina Pollution Control Act.

B. X-Large swine facilities shall be assessed automatic penalties (up to \$10,000 per day per violation) for the following violations:

1. Lagoon, treatment system, or manure storage pond breach, or loss of containment that is not the direct result of an Act of God.

2. Manure Utilization Area runoff due to improper manure application methods.

3. Discharge to groundwater on site causing groundwater to exceed any water quality standard established in R.61-68.

C. Second occurrence of any of the violations outlined in 100.200.B. at an X-large swine facility shall result in immediate revocation of the permit and the automatic assessment of appropriate penalties.

D. Immediate cessation of manure application will also be enforced on sites where groundwater quality is adversely affected.

E. Any person who falsifies, tampers with, or knowingly renders inaccurate any monitoring device or method required by the Department to be maintained as a condition in a permit, or who alters or falsifies the results obtained by such devices or methods, shall be deemed to have violated a permit

condition and shall be subject to the penalties provided for pursuant to Sections 48-1-320 and 48-1-330 of the S.C. Code of Regulations.

HISTORY: Amended by SCSR 45-5 Doc. No. 4997, eff May 28, 2021.

PART 200
ANIMAL FACILITIES (OTHER THAN SWINE)

200.10. Purpose, Applicability, Inactive Facilities, and Facilities Permitted Prior to the Effective Date of the Regulation.

A. Purpose.

1. To establish standards for the growing or confining of animals, processing of animal manure and other animal by-products, and land application of animal manure and other animal by-products in such a manner as to protect the environment, and the health and welfare of citizens of the State from pollutants generated by this process.

2. To establish standards, which consist of general requirements, constituent limits, management practices, and operational standards, for the utilization of animal manure and other animal by-products generated at animal facilities. Standards included in this part are for animal manure and other animal by-products applied to the land.

3. To establish standards for the frequency of monitoring and record keeping requirements for producers who operate animal facilities.

4. To establish standards for the proper operation and maintenance of animal facilities.

5. To establish criteria for animal facilities' and manure utilization areas' location as they relate to protection of the environment and public health. The location of animal facilities and manure utilization areas as they relate to zoning in an area is not covered in this regulation. Local county or municipal governments may have zoning requirements and this regulation neither interferes with nor restricts such zoning requirements. Permit applicants should contact local municipal and county authorities to determine any local requirements that may be applicable.

B. Applicability.

1. This part applies to:

- a. All new animal facilities;
- b. All expansions of existing animal facilities;
- c. New manure utilization areas for existing animal facilities;
- d. All inactive facilities; and
- e. All facilities and lagoon closures.

2. This part applies to all animal manure and other animal by-products applied to the land.

3. This part applies to all land where animal manure and other animal by-products are applied.

C. Inactive Facilities.

1. If an animal facility is inactive for two (2) years or less, a producer may resume operations of the facility under the same conditions by which it was previously permitted by notifying the Department in writing that the facility is being operated again.

2. For animal facilities that have been inactive for more than two (2) years but less than five (5) years, the Department shall review the existing permit and modify its operating conditions as necessary prior to the facility being placed back into operation.

3. For all other than swine animal facilities that have been inactive for five (5) or more years, the producer shall properly close out any lagoon, treatment system, or manure storage pond associated with the facility. The closeout shall be accomplished in accordance with R.61-82. The permittee shall submit a closeout plan that meets, at a minimum, NRCS-CPS within a time frame prescribed by the Department. Additional time may be granted by the Department to comply with the closeout requirement or to allow the producer to apply for a new permit under this regulation, as appropriate.

4. If an animal facility is inactive for more than five (5) years, the permit is considered expired and the producer shall apply for a new permit and all requirements of this regulation shall be met before the facility can resume operations.

5. During the closeout of the facilities and/or lagoons/waste storage ponds, annual fees are required until proper closeout is certified and approved.

D. Facilities Permitted Prior to the Effective Date of the Regulation.

1. All existing animal facilities with permits issued by the Department before June 26, 1998, do not need to apply for a new permit as they are deemed permitted (deemed permitted animal facilities) unless they have been inactive for more than two (2) years or expand operations. These facilities shall meet the following sections of Part 200: Section 200.20 (Permits and Compliance Period); Section 200.90.A, D, and J-O (General Requirements for Animal Manure Lagoons, Treatment Systems, and Animal Manure Storage Ponds); Section 200.100. (Manure Utilization Area Requirements); Section 200.110.H-I (Spray Application System Requirements); Section 200.120.A, C-D (Frequency of Monitoring for Animal Manure); Section 200.130.A, B, and C.2.-3. (Dead Animal Disposal Requirements); Section 200.140.A, C-I (Other Requirements); Section 200.150.B-F (Odor Control Requirements); Section 200.160.B-D (Vector Control Requirements); Section 200.170 (Record Keeping); Section 200.180 (Reporting); Section 200.190 (Training Requirements); and Section 200.200 (Violations). The capacity of a deemed permitted facility that does not have a lagoon is the number of animals and normal production animal live weight permitted by the Department prior to the effective date of this regulation. For deemed permitted facilities with lagoons, the capacity is the maximum capacity of the existing animal manure lagoon, treatment system, and animal manure storage pond as determined using the appropriate animal manure lagoon, treatment system, and animal manure storage pond capacity design criteria of the United States Department of Agriculture's Natural Resource Conservation Service.

2. All existing animal facilities with permits issued by the Department between June 26, 1998, and the effective date of this regulation do not need to apply for a new permit if they hold a valid permit from the Department, unless they have been inactive for more than two (2) years. These facilities shall meet all the requirements of this regulation.

3. All existing animal facilities that were constructed and placed into operation prior to June 26, 1998, but have never received an agricultural permit from the Department, shall apply for a permit from the Department. This facility shall meet all the requirements of this regulation as the Department determines appropriate. The Department shall review the site and make a determination on a case-by-case basis on which requirements are applicable.

4. An existing animal facility may be required to submit an updated Animal Facility Management Plan on a case-by-case basis by the Department. The Department shall notify the permittee in writing of this requirement. The permittee has six (6) months or an agreed upon time frame from the date of notification to submit an updated Animal Facility Management Plan. Failure to submit the updated plan within this time frame is a violation of the South Carolina Pollution Control Act and this regulation, and may result in permit revocation.

5. Both the setbacks and other requirements for manure utilization areas shall be met when a new manure utilization (MUA) area is added by the owner of any animal facility regardless of when the facility was permitted.

6. If an existing animal facility regulated under this part proposes to convert to a swine facility, it shall be considered a new swine facility under this regulation. Converted facilities shall be permitted as new swine facilities and meet all criteria for new swine facilities before they begin operation as a swine facility.

HISTORY: Amended by SCSR 45-5 Doc. No. 4997, eff May 28, 2021.

200.20. Permits and Compliance Period.

A. Permit Requirement. Animal manure and other animal by-products from a new or expanded animal facility can only be generated, handled, stored, treated, processed, or land applied in the State in accordance with a permit issued by the Department under the provisions of this part. Existing producers that are required by the Department to update their Animal Facility Management Plan shall meet the requirements of this part to the extent practical as determined by the Department.

B. Permits issued under this regulation are no-discharge permits.

C. The requirements in this part shall be implemented through a permit issued to any producer who operates an animal facility where animal manure and other animal by-products are generated, handled, treated, stored, processed, or land applied.

D. The requirements under this part may be addressed in permits issued to producers who only land apply animal manure and other animal by-products.

E. Notification Requirements. The permittee shall notify the Department in writing and receive written Departmental approval, except as otherwise noted, prior to any change in operations at a permitted facility, including, but not limited to, the following:

1. Change in ownership and control of the facility. The Department has thirty (30) calendar days from the receipt of a complete and accurate notification of transfer of ownership to either: request additional information regarding the transfer or the new owner; deny the transfer; or approve the transfer of ownership. If the Department does not act within thirty (30) calendar days, the transfer is automatically approved. If additional information is requested by the Department in a timely manner, the Department shall act on this additional information, when it is received, within the same time period as the initial notification.

2. Increase in the permitted number of animals.

3. Addition of manure utilization areas.

4. Change in animal manure and other animal by-products treatment, handling, storage, processing, or utilization.

5. Change in method of dead animal disposal.

F. Permit modifications for items 200.20.E.2 and 200.20.E.4 for facilities regulated under this part, which will result in expansions, shall adhere to the requirements of this part and other applicable statutes, regulations, or guidelines.

G. Permit modification for item 200.20.E.2 which result in an expansion may be required to obtain new written waivers or agreement for reduction of setbacks from adjoining property owners (if applicable).

HISTORY: Amended by SCSR 45-5 Doc. No. 4997, eff May 28, 2021.

200.30. Exclusions.

The following do not require permits from this part unless specifically required by the Department under item 200.30.G.

A. Existing animal facilities that are deemed permitted under Section 200.10.D.1 are excluded from applying for a new permit unless an expansion is proposed, new manure utilization areas are added, or as required by the Department. However, deemed permitted facilities shall meet the requirements of this regulation as outlined in Section 200.10.D (Purpose, Applicability, Inactive Facilities, and Facilities Permitted Prior to the Effective Date of the Regulation).

B. Except as given in Section 200.30.G, animal facilities with only ranged animals, and no lagoon, treatment system, or manure storage pond is associated with the facility, are excluded from obtaining a permit from the Department. The range area shall be of sufficient size to allow for natural degradation or utilization of the animal manure with no adverse impact to the environment. Ranged facilities shall also maintain adequate vegetative buffers between the animal range and Waters of the State.

C. Except as given in Section 200.30.G, animal facilities, which do not have a lagoon, manure storage pond, or liquid manure treatment system, having 10,000 pounds or less of normal production animal live weight at any one time are excluded from obtaining a permit from the Department. However, these facilities shall have and implement an Animal Facility Management Plan for their facility that meets the requirements of this regulation.

D. Except as given in Section 200.30.G, animal facilities, which do not have a lagoon, manure storage pond, or liquid manure treatment system, having more than 10,000 pounds of normal production animal live weight at any one time and having less than 30,000 pounds of normal production animal live weight at any one time are excluded from obtaining a permit from the Department. However, these facilities shall submit an Animal Facility Management Plan to the

Department and implement an Animal Facility Management Plan for their facility that meets the requirements of this regulation.

E. Except as given in Section 200.30.G, animal facilities that are not classified as commercial facilities are excluded from obtaining a permit from the Department.

F. Except as given in Section 200.30.G, animal facilities that hold valid permits issued by the Department are not required to obtain a new permit if they decide to replace in kind any of the animal growing houses.

G. Animal facilities exempted under Sections 200.30.A, B, C, D, E, and F may be required by the Department to obtain a permit. The Department shall visit the site before requiring any of these facilities to obtain a permit.

HISTORY: Amended by SCSR 45-5 Doc. No. 4997, eff May 28, 2021.

200.40. Relationship to Other Regulations.

The following regulations are referenced throughout this part and may apply to facilities covered under this regulation.

A. Application and annual operating fees are addressed in R.61-30, Environmental Protection Fees.

B. The proper closeouts of wastewater treatment facilities are addressed in R.61-82, Proper Closeout of Wastewater Treatment Facilities. This includes animal lagoons and manure storage ponds.

C. Setbacks and construction specifications for potable water wells and monitoring wells shall be in accordance with R.61-71, Well Standards.

D. Permits for air emissions from incinerators are addressed in R.61-62, Air Pollution Control Regulations and Standards.

E. Disposal of animal manure in a municipal solid waste landfill unit is addressed in R.61-107.19, Solid Waste Management: Solid Waste Landfills and Structural Fill.

F. Disposal of animal manure with domestic or industrial sludge is addressed in R.61-9, Water Pollution Control Permits, and permitted under R.61-9.

G. Laboratory certification is addressed in R.61-81, State Environmental Laboratory Certification Program.

H. Water Classifications and Standards are addressed in R.61-68.

HISTORY: Amended by SCSR 45-5 Doc. No. 4997, eff May 28, 2021.

200.50. Permit Application Procedures (Animal Facility Management Plan Submission Requirements).

A. Preliminary Site Evaluations. The Department shall perform a preliminary evaluation of the proposed site at the request of the applicant. Written requests for a preliminary site inspection shall be made using a form provided by the Department. The Department shall not schedule a preliminary site inspection until all required information specified in the form has been submitted to the Department. This evaluation should be performed prior to preparation of the Animal Facility Management Plan. Once the preliminary site inspection is performed, the Department shall issue an approval or disapproval letter for the proposed site.

B. A producer who proposes to build a new animal facility or expand an existing animal facility shall make application for a permit under this part using an application form provided by the Department. The following information shall be included in the application package.

1. A completed and accurate application form.

2. An Animal Facility Management Plan prepared by qualified Natural Resources Conservation Service (NRCS) personnel or a S.C. registered professional engineer (PE). Other qualified individuals, such as certified soil scientists or S.C. registered professional geologists (PG), may prepare the land application component of an Animal Facility Management Plan. The Animal Facility Management Plan shall, at a minimum, contain:

a. Facility name, address, telephone numbers, email address (if applicable), county, and National Pollutant Discharge Elimination System Permit or other permit number (if applicable);

- b. Facility location description and the zoning or land use restrictions in this area (this information is available from the county);
- c. Applicant's name, address, email, and telephone number (if different from above);
- d. Operator's name and CAMM number (if available)
- e. Facility capacity;
 - i. Number and type of animals;
 - ii. Pounds of normal production animal live weight at any one time;
 - iii. Amount of animal manure and other animal by-products generated per year (gallons for liquid animal manure and pounds for dry animal manure);
 - iv. Amount in tons of any scraped or separated solid animal manure and other animal by-products generated per year (if applicable);
 - v. Description of animal manure and other animal by-products storage and storage capacity of lagoon, treatment system, or manure storage pond (if applicable); and
 - vi. Description of animal manure and other animal by-products treatment (if any).
- f. Concentration of constituents in liquid animal manure including, but not limited to, the constituents given below:
 - i. Nutrients.
 - (a) Nitrate (only needed for aerobic systems).
 - (b) Ammonium-Nitrogen.
 - (c) Total Kjeldahl Nitrogen (TKN).
 - (d) Organic-Nitrogen (TKN - Ammonium-Nitrogen).
 - (e) P₂O₅.
 - (f) K₂O (potash).
 - ii. Constituents.
 - (a) Arsenic.
 - (b) Copper.
 - (c) Zinc.
 - iii. Name, address, S.C. lab certification number, and telephone number of the laboratory conducting the analyses.
 - iv. For new animal facilities, liquid animal manure analysis information does not have to be submitted as the Department shall use manure analyses from similar sites or published data (such as: Clemson University, American Society of Agricultural Engineers, Midwest Planning Service Document, NRCS Technical Guide or equivalent) in review of the application. Analysis of the actual animal manure generated shall be submitted to the Department twelve (12) months after a new animal facility starts operation or prior to the first application of animal manure to a manure utilization area, whichever occurs first. If this analysis is significantly different from the estimated analysis used in the permitting decision, the Department may require a permit modification as necessary to address the situation. Analysis shall be conducted by a laboratory certified by the Department. This laboratory shall have and maintain certification for the constituents to be analyzed.
- g. Concentration of constituents in dry animal manure including, but not limited to, the following:
 - i. Nutrients (on a dry weight basis).
 - (a) Total Kjeldahl Nitrogen (mg/kg).
 - (b) Total inorganic nitrogen (mg/kg).
 - (c) Total ammonia nitrogen (mg/kg) and Total nitrate, nitrogen (mg/kg).
 - (d) P₂O₅ (mg/kg).
 - (e) K₂O (mg/kg).

- (f) Calcium Carbonate equivalency (if animal manure is alkaline stabilized).
- ii. Constituents (on a dry weight basis).
 - (a) Arsenic (mg/kg).
 - (b) Copper (mg/kg).
 - (c) Zinc (mg/kg).
- iii. Name, address, S.C. lab certification number, and telephone number of the laboratory conducting the analyses.
- iv. For new animal facilities, dry animal manure analysis information does not have to be submitted as the Department shall use manure analyses from similar sites or published data (such as: Clemson University, American Society of Agricultural Engineers, Midwest Planning Service Document, NRCS Technical Guide or equivalent) in review of the application. Analysis of the actual dry animal manure generated shall be submitted to the Department twelve (12) months after a new animal facility starts operation or prior to the first application of animal manure to a manure utilization area, whichever occurs first. If this analysis is significantly different from the estimated analysis used in the permitting decision, the Department may require a permit modification as necessary to address the situation. Analysis shall be conducted by a laboratory certified by the Department. This laboratory shall have and maintain certification for the constituents to be analyzed.
- h. Animal manure and other animal by-products handling and application information shall be included as follows:
 - i. A crop management plan which includes the time of year of the animal manure application and how it relates to crop type, crop planting, and harvesting schedule (if applicable) for all manure utilization areas;
 - ii. Name, address, and telephone number of the producer(s) that will land apply the animal manure and other animal by-products if different from the permittee;
 - iii. Type of equipment used to transport and/or spread the animal manure and other animal by-products (if applicable); and
 - iv. For spray application systems, plans and specifications with supporting details and design calculations for the spray application system.
- i. Facility and manure utilization area information shall be included (as appropriate):
 - i. Name, address, and tax map number of landowner and location of manure utilization area(s);
 - ii. List previous calendar years that animal manure and other animal by-products were applied and application amounts, where available;
 - iii. Facility and manure utilization area location(s) on maps drawn to approximate scale including:
 - (a) Topography (7.5' or equivalent) and drainage characteristics (including ditches);
 - (b) Adjacent land usage (within 1/4 mile of property line minimum) and location of inhabited dwellings and public places showing property lines and tax map number;
 - (c) All known water supply wells on the applicant's property and within 200 feet of the facility's property line or within 200 feet of any manure utilization areas;
 - (d) Adjacent surface water bodies (including ephemeral and intermittent streams);
 - (e) Animal manure utilization area boundaries and buffer zones;
 - (f) right-of-ways (Utilities, roads, etc.);
 - (g) Soil types as given by soil tests or soils maps, a description of soil types, and boring locations (if applicable);
 - (h) Recorded plats, surveys, or other acceptable maps that include property boundaries; and
 - (i) Information showing the 100-year and 500-year floodplain (as determined by FEMA).

iv. For manure utilization areas not owned by the permit applicant, a signed agreement between the permit applicant and the landowner acceptable to the Department detailing the liability for the land application. The agreement shall include, at a minimum, the following:

(a) Producer's name, farm name, farm address, CAMM number, and county in which the farm is located;

(b) Landowner's name, address, phone number;

(c) Location (map with road names, tax map numbers, and county identified) of the land to receive manure application;

(d) Field acreage, acreage less setbacks, and crops grown;

(e) Name of manure hauler;

(f) Name of manure applier;

(g) A statement that land is not included in any other management plans and manure or compost from another farm is not being applied on this land; and any manure utilization areas that are included in multiple Animal Facility Management Plans, identify the names of all facilities that include this manure utilization area in their plan; and

(h) A signed statement which informs the landowner that he or she is responsible for spreading and utilizing this manure in accordance with the requirements of the Department and this regulation.

3. Groundwater monitoring well details and proposed groundwater monitoring program (if applicable).

4. The Animal Facility Management Plan shall contain an odor abatement plan for the animal facility, lagoon, treatment system, manure storage pond, and manure utilization areas. For more specific details, see Section 200.150 (Odor Control Requirements).

5. A Vector Abatement Plan shall be included for the animal facility, lagoon, treatment system, manure storage pond, and manure utilization areas. For more specific details see Section 200.160 (Vector Control Requirements).

6. The Dead Animal Disposal Plan shall include written details for the handling and disposal of dead animals. Plans should detail method of disposal, any construction specifications necessary, and management practices. See Section 200.130 (Dead Animal Disposal Requirements) for specific requirements on dead animal disposal.

7. A Soil Monitoring Plan shall be developed for all manure utilization areas. See Section 200.100 (Manure Utilization Area Requirements) for more detailed information.

8. Plans and specifications for all other manure treatment or storage structures, such as holding tanks or manure storage sheds.

9. All "Notice of Intent to Build or Expand an Animal Facility" forms provided by the Department and a tax map (or equivalent) to scale showing all neighboring property owners and identifying which property has inhabited dwellings. See Section 200.60 (Public Notice Requirements) for more detailed information.

10. An Emergency Plan. The emergency plan should, at a minimum, contain a list of entities or agencies the producer shall contact in the event of lagoon, treatment system, or manure storage pond breach, mass animal mortality, fire, flood, or other similar type problem. For facilities in the coastal areas of the state, the emergency plan should address actions to be taken by a producer during hurricane season (such as providing additional freeboard during that time) and when advance warning is given on any extreme weather condition.

11. All waivers as specified in Section 200.80 (Facility, Lagoon, Treatment System, and Manure Storage Pond Siting Requirements), if applicable.

12. Application fee and first year's operating fee as established by R.61-30.

C. The Department may request an applicant to provide any additional information deemed necessary to complete or correct deficiencies in the animal facility permit application prior to processing the application or issuing, modifying, or denying a permit.

D. Applicants shall submit all required information in a format acceptable to the Department.

E. An application package for a permit is complete when the Department receives all of the required information which has been completed to its satisfaction. Incomplete submittal packages may be returned to the applicant by the Department.

F. Application packages for permit modifications only need to contain the information applicable to the requested modification or any additional information the Department deems necessary.

HISTORY: Amended by SCSR 45-5 Doc. No. 4997, eff May 28, 2021.

200.60. Public Notice Requirements.

A. For new animal facilities, the applicant shall notify all property owners within 1,320 feet of the proposed location of the facility (footprint of construction) of the applicant's intent to build an animal facility. The applicant shall use a notice of intent form provided by the Department. The Department shall post the Public Notice of application received on the Department's website for fifteen (15) business days. The Department may also post up to four (4) notices, in the four (4) cardinal directions around the perimeter of the property or in close proximity to the property, in locations visible to the public within the public right-of-ways determined by the Department. The notice of intent on the Department's website shall advise adjoining property owners that they can send comments on the proposed animal facility directly to the Department.

B. For properties that have multiple owners or properties that are in an estate with multiple heirs, the Department, shall publish a notice of intent to construct an animal facility on the Department's website. This notice on the Department's website shall serve as notice to these multiple property owners of the producer's intent to build an animal facility.

C. For existing animal facilities seeking to expand their current operations, the Department shall post the Public Notice of application received on the Department's website for fifteen (15) business days. The Department may also post up to four (4) notices in the four (4) cardinal directions around the perimeter of the property or in close proximity to the property, in locations visible to the public right-of-way or as determined by the Department.

D. The Department shall review all comments received. If the Department receives twenty (20) or more letters from different "Affected Persons" requesting a meeting or the Department determines significant comment exists, a meeting shall be held to discuss and seek resolution to the concerns prior to a permit decision being made. All persons who have submitted written comments shall be invited in writing to the meeting. First Class US mail service, email, or hand delivery to the address of a person to be notified shall be used by the Department for the meeting invitation. However, if the Department determines that the number of persons who submitted written comments is significant, the Department shall publish a notice of the public meeting on the Department's website instead of notifying each individual by First Class mail or email. In addition, the Department shall notify all group leaders and petition organizers in writing. Agreement of the parties is not required for the Department to make a permit decision.

E. When comments are received by email, the Department shall acknowledge receipt of the comment by email. These comments shall be handled in the same manner as written comments received by postal mail.

F. The Department shall consider all relevant comments received in determining a permit decision.

G. The Department shall give notice of the permit decision to issue or deny the permit to the applicant, all persons who commented in writing to the Department, and all persons who attended the meeting, if held. First Class US mail service or email shall be used by the Department for the notice of decision. However, if the Department determines that members of the same group or organization have submitted comments or a petition, the Department shall only notify all group leaders and petition organizers in writing. The Department shall ask these leaders and organizers to notify their groups or any concerned citizens who signed the petitions.

H. For permit issuances, the Department shall publish a notice of issuance of a permit to construct or expand an animal facility on the Department's website.

I. For permit denials, the Department shall give the permit applicant a written explanation, which outlines the specific reasons for the permit denial.

J. For permit denials, the Department shall publish a notice of decision on the Department's website.

K. The Department shall include, at a minimum, the following information in the public notices on permit decisions: the name and location of the facility; a description of the operation and the method of manure handling; instructions on how to appeal the Department's decision; the time frame for filing an appeal; the date of the decision; and the date upon which the permit becomes effective.

HISTORY: Amended by SCSR 45-5 Doc. No. 4997, eff May 28, 2021.

200.70. Permit Decision Making Process.

A. No permit shall be issued before the Department receives a complete application package.

B. The agricultural program of the Department is not involved in local zoning and land use planning. Local government(s) may have more stringent requirements for agricultural animal facilities. The permittee is responsible for contacting the appropriate local government(s) to ensure that the proposed facility meets all the local requirements.

C. After the Department has received a complete application package, a technical review shall be conducted by the Department. The Department may request any additional information or clarification from the applicant or the preparer of the Animal Facility Management Plan to help with the determination on whether a permit should be issued or denied. If a permit application package meets all applicable requirements of this part, a permit may be issued.

D. A preliminary site inspection shall be made by the Department before a complete application package is received by the Department.

E. The Department shall act on all permits to prevent, so far as reasonably possible considering relevant standards under state and federal laws, an increase in pollution of the waters and air of the State from any new or enlarged sources.

F. The setback limits given in Part 200 are siting requirements. The Department shall evaluate the following factors to determine if any special conditions are necessary:

1. Latitude and Longitude;
2. Down-wind receptors; and
3. Nutrient Management Plan.

G. When a permit is issued, it shall contain an issue date, an effective date, and, when applicable, a construction expiration date. The effective date shall be at least fifteen (15) calendar days after the issue date to allow for any appeals. If a timely appeal is not received, the permit shall be effective on the effective date.

H. An expired permit (final expiration date for renewal) issued under this part continues in effect until a new permit is effective if the permittee submits a complete application, to the satisfaction of the Department, at least one hundred eighty (180) calendar days before the existing permit expires. The Department may grant permission to submit an application later than the deadline for submission stated above, but no later than the permit expiration date. If the facility has been closed for any two (2) consecutive years since the last permit was issued, the provision for the expiring permit remaining in effect does not apply since the permit is no longer valid. Permittees shall notify the Department in writing within thirty (30) calendar days of when they go out of business.

I. The animal facility, lagoon, treatment system, or manure storage pond can be built only when the permit is effective. The facility cannot be placed into operation until the Department has issued a written Approval to Operate (ATO).

J. To receive an ATO, the producer shall have the preparer of the Animal Facility Management Plan submit to the Department written certification that the construction has been completed in accordance with the approved Animal Facility Management Plan and the requirements of this regulation.

K. The Department shall conduct a final inspection before granting an ATO to a producer to begin operations.

L. The Department shall grant written approval for the producer to begin operations after it has received the certification statement in 200.70.J and the results of the final inspection are satisfactory.

M. Animal Facility Construction Permit Expiration and Extensions.

1. Construction permits issued by the Department for agricultural animal facilities shall be given two (2) years from the effective date of the permit to start construction and three (3) years from the effective date of the permit to complete construction.

2. If the proposed construction as outlined in the permit is not started prior to the construction start expiration date, the construction permit is invalid unless an extension in accordance with this regulation is granted.

3. If construction is not completed and the facility is not placed into operation prior to the construction completion expiration date, the construction permit is invalid unless an extension in accordance with this regulation is granted.

4. If a portion of the permitted facility (some of the animal growing houses are completely constructed, but not all houses originally permitted were constructed) is completed prior to the construction completion expiration date, the construction for the remainder of the permit may be utilized within the permit life. The permittee shall obtain Departmental approval prior to utilizing the permit in this manner. The Department may require that the permittee submit additional information or update the Animal Facility Management Plan prior to approval.

5. Extensions of the permit construction start and completion expiration dates may be granted by the Department. The permittee shall submit a written request explaining the delay and detailing any changes to the proposed construction. This request shall be received no later than the expiration date that the permittee proposes to extend. The maximum extension period shall not exceed one (1) year. There shall be no more than two (2), one (1)-year extension periods per permit to construct, granted.

HISTORY: Amended by SCSR 45-5 Doc. No. 4997, eff May 28, 2021.

200.80. Animal Facility, Lagoon, Treatment Systems, and Manure Storage Pond Siting Requirements.

A. Siting requirements applicable to all animal facilities.

1. The minimum separation distance between an animal facility (animal growing areas, houses, pens or barns, not including range areas or manure utilization areas) and a public or private drinking water well (excluding the applicant's well) is 200 feet. The minimum separation distance between an animal facility and a potable water well owned by the applicant is 50 feet (as required by R.61-71).

2. The minimum separation distance between an animal facility and Waters of the State (including ephemeral and intermittent streams) located down slope from the facility is 100 feet.

3. Except for site drainage, the minimum separation distance required between an animal facility and a ditch or swale located down slope from the facility is 50 feet.

4. A new animal facility or an expansion of an established animal facility shall not be located in the 100-year floodplain.

5. The separation distance required between a small animal facility or growing areas (pens or barns not including range areas) and the lot line of real property owned by another person is 200 feet and 1,000 feet from the nearest residence.

6. The separation distance required between large or X-large animal facilities or growing areas (pens or barns not including range areas) and the lot line of real property owned by another person is 400 feet and 1,000 feet from the nearest residence.

B. Siting requirements applicable to all animal lagoons, treatment systems, and manure storage ponds.

1. The minimum separation distance between a lagoon, treatment system, or manure storage pond and a public or private drinking water well (excluding the applicant's well) is 200 feet. The minimum separation distance between an animal lagoon, treatment system, or manure storage pond and a potable water well owned by the applicant is 100 feet.

2. Except for site drainage, the minimum separation distance required between an animal lagoon, treatment system, or manure storage pond and a ditch or swale located down slope from the facility is 50 feet.

3. The minimum separation distance required between an animal lagoon, treatment system, or manure storage pond and Waters of the State (including ephemeral and intermittent streams) located down slope from the facility is 100 feet. If the Waters of the State are designated Outstanding Resource Waters, Critical Habitat Waters of federally endangered species, or Shellfish Harvesting Waters, the minimum separation distance required between a lagoon, treatment system, or manure storage pond and Waters of the State is 500 feet.

4. A new animal lagoon, treatment system, or manure storage pond or an expansion of an established animal lagoon, treatment system, or manure storage pond shall not be located in the 100-year floodplain.

5. The separation distance required between a small animal facility lagoon, treatment system, or manure storage pond and real property owned by another person is 300 feet or 1,000 feet from the nearest residence.

6. The separation distance required between a large animal facility lagoon, treatment system, or manure storage pond and real property owned by another person is 500 feet and 1,000 feet from the nearest residence.

7. The separation distance required between an X-large animal facility lagoon, treatment system, or manure storage pond and real property owned by another person is 600 feet and 1,320 feet from the nearest residence.

C. Siting requirements applicable to all dry animal manure and other animal by-products treatment or storage facilities (including, but not limited to, stacking sheds, burial sites, incinerators, manure, and dead animal composters).

1. The minimum separation distance between a dry animal manure and other animal by-products treatment or storage facility and a public or private drinking water well (excluding the applicant's well) is 100 feet. The minimum separation distance between a dry animal manure and other animal by-products treatment or storage facility and a potable water well owned by the applicant is 50 feet.

2. Except for site drainage, the minimum separation distance required between a dry animal manure and other animal by-products treatment or storage facility and a ditch or swale located down slope from the facility is 50 feet.

3. The minimum separation distance between a dry animal manure and other animal by-products treatment or storage facility and Waters of the State including ephemeral and intermittent streams located down slope from the facility is 100 feet.

4. A new dry animal manure and other animal by-products treatment or storage facility or an expansion of an established dry animal manure and other animal by-products treatment or storage facility shall not be located in the 100-year floodplain.

5. The separation distance required between a dry animal manure and other animal by-products treatment or storage facility operated at an animal growing facility and the lot line of real property and a residence owned by another person shall be equivalent to the setback required for the animal growing areas or houses.

6. The minimum separation distance required between a dry animal manure and other animal by-products treatment or storage facility operated by a manure broker and the lot line of real property owned by another person is 200 feet and 1,000 feet to the nearest residence.

D. Water (a pond) that is completely surrounded by land owned by the permit applicant and has no connection to surface water is excluded from the setback requirements outlined in this part.

E. All lagoon and manure storage pond setbacks contained in this part shall be measured from the outside toe of the dike.

F. The separation distances for property lines given in Section 200.80.A, B, and C above can be waived or reduced by written consent of the adjoining property owner. Written consent is not needed when the Department reduces the distances under the requirements of Part 300.

HISTORY: Amended by SCSR 45-5 Doc. No. 4997, eff May 28, 2021.

200.90. General Requirements for Animal Manure Lagoons, Treatment Systems, and Animal Manure Storage Ponds.

A. The lagoon, treatment system, or manure storage pond shall be designed by a professional engineer or an NRCS engineer and the construction shall be certified by the design engineer or professional engineer licensed in S.C. It is a violation of these regulations and the South Carolina Pollution Control Act for the owner or operator of the facility to make modifications or physical changes to the lagoon, treatment system, or manure storage pond without the prior approval of the Department and supervision of NRCS or a professional engineer. Plans and specifications for lagoon, treatment system, or manure storage pond modifications shall be designed and certified by NRCS or a professional engineer and submitted to the Department for approval prior to the modification.

B. Animal manure lagoons and manure storage ponds shall be designed, at a minimum, to NRCS-CPS. The lagoon or manure storage pond shall be designed to provide a minimum storage for manure, wastewater, normal precipitation less evaporation, normal runoff, residual solids accumulation, capacity for the fifty (50) year-twenty-four (24) hour storm event (precipitation and associated runoff) and at least 2 feet of freeboard.

C. All lagoons and storage ponds shall be provided with a liner, designed with an initial specific discharge rate of less than 0.0156 feet/day, in order to protect groundwater quality. When lagoons or manure storage ponds are lined only using soils with low permeability rates (e.g., clay), the Department shall require appropriate documentation to demonstrate that the computed soil permeability rates of the liner are sufficiently low or certification from the preparer of the Animal Facility Management Plan that the NRCS design standards for lining lagoons and/or manure storage ponds with soils have been met. When geomembrane liners are utilized, they shall be designed, at a minimum, to meet NRCS-CPS.

D. If seepage results in either an adverse impact to groundwater or a significant adverse trend in groundwater quality occurs as determined by the Department, the lagoon or manure storage pond shall be repaired at the owner's or operator's expense. Assessment and/or additional monitoring (more wells, additional constituents, and/or increased sampling frequency) may be required by the Department to further assess the extent of the seepage. The repairs and/or assessment shall be completed in accordance with an implementation schedule approved by the Department. The Department may require groundwater corrective action.

E. Manure shall not be placed directly in or allowed to come into contact with groundwater and/or surface water. The minimum separation distance between the lowest point of the lagoon or manure storage pond and the seasonal high water table beneath the lagoon or manure storage pond is 2 feet. If a geomembrane liner is installed, the minimum separation distance is 1 foot from the seasonal high water table. Designs that include controlled drainage for water table adjustment shall be evaluated by the Department on a case-by-case basis, and may include additional monitoring and groundwater control requirements. If a design is proposed for water table adjustment, the design shall not impact wetlands.

F. Monitoring wells may be required by the Department on a case-by-case basis upon Department review of the submittal package.

G. A groundwater monitoring plan shall be submitted with the permit application to the Department. All applicable State certification requirements regarding well installation, laboratory analyses, and report preparation shall be met. Each groundwater monitoring well installed shall be permitted and shall be sampled at least once annually by qualified personnel at the expense of the permittee. The results shall be submitted to the Department in accordance with the specified permit requirements. Groundwater Sampling results shall be maintained by the producer for eight (8) years. The Department may conduct routine and random visits to the animal facility to sample the monitoring wells.

H. Prior to operation of the lagoon or manure storage pond, all monitoring wells shall be sampled in accordance with the parameters identified in the permit such that a background concentration level can be established.

I. Before the construction of a lagoon and/or a manure storage pond, the owner or operator shall remove all under-drains that exist from previous agricultural operations that are under the lagoon or manure storage pond and/or within 25 feet of the outside toe of the proposed lagoon or manure

storage pond dike. This requirement does not include under-drains that are approved as a part of designs that include controlled drainage for water table adjustment.

J. Proper water levels in lagoons and manure storage ponds, as per plans and specifications, shall be maintained at all times by the permittee. The Department may require specific lagoon or manure storage pond volume requirements in permits. An approved marker shall be installed to measure water levels.

K. If a lagoon, treatment system, or manure storage pond, all of these, breaches or fails, the owner or operator of the animal facility shall immediately notify the Department, the appropriate local government officials, and the owners or operators of any potable surface water treatment plant located downstream from the animal facility that could reasonably be expected to be adversely impacted.

L. Lagoons, treatment systems, and manure storage ponds shall be completely enclosed with an acceptable fence, unless a fence waiver is obtained from the Department.

M. Lagoons and manure storage ponds shall have at least four (4) warning signs posted in the four (4) cardinal directions around the perimeter of the structure. These signs must read, "Warning - Deep and Polluted Water".

N. Vegetation on the dikes and around the lagoon, treatment system, or manure storage pond should be kept below a maximum height of 18 inches. Trees or deeply rooted plants shall be prevented from growing on the dikes or within 25 feet of the outside toe of the dikes of the lagoon, treatment system, or manure storage pond. Existing trees on the dikes shall be evaluated by NRCS staff or a dam engineer licensed in South Carolina to determine if they should be removed or remain.

O. Livestock or other animals that could cause erosion or damage to the dikes of the lagoon, treatment system, or manure storage pond shall not be allowed to enter the lagoon, treatment system, or manure storage pond, or graze on the dike or within 25 feet of the outside toe of the dike.

P. The Department shall require existing facilities, regardless of size, with a history of manure handling, treatment, and disposal problems related to a lagoon, to phase out the existing lagoon and incorporate new technology.

HISTORY: Amended by SCSR 45-5 Doc. No. 4997, eff May 28, 2021.

200.100. Manure Utilization Area Requirements.

A. Application Rates. The Department shall approve an Animal Facility Management Plan that establishes an application rate for each manure utilization area based on the agronomic application rate of the specific crop(s) being grown, and the manure and other animal by-products' impact on the environment. The application rate shall be based on the limiting constituent (a nutrient or other constituent as given in item 200.100.B). In developing annual constituent loading rates and cumulative constituent loading rates, the Department shall consider:

1. Soil type;
2. Type of vegetation growing in land-applied area;
3. Proximity to 100-year floodplain;
4. Location in watershed;
5. Nutrient sensitivity of receiving land and waters;
6. Soil nutrient testing in conjunction with soil productivity information;
7. Nutrient, copper, zinc, and constituent content of the manure and other swine by-products being applied;
8. Proximity to a State Approved Source Water Protection Area;
9. Proximity to other point and nonpoint sources;
10. Slope of land (anything over ten percent (10%) must use runoff best management practices, runoff controls, or conservation features as per NRCS);
11. Distance to water table or groundwater aquifer;
12. Timing of manure application to coincide with vegetative cover growth cycle;
13. Timing of harvest of vegetative cover;

- 14. Hydraulic loading limitations;
- 15. Soil assimilative capacity;
- 16. Type of vegetative cover and its nutrient uptake ability;
- 17. Method of land application; and
- 18. Aquifer vulnerability.

B. Constituent Limits for Land Application of Liquid and Dry Animal manure and other animal by-products and Operational Practices for Land Application.

1. Animal manure and other animal by-products containing only the standard constituents at normal concentrations as given by commonly accepted reference sources, such as Clemson University, American Society of Agricultural Engineers, Midwest Planning Service Document, or NRCS, can be land applied at or below agronomic rates without any specific constituent limits in a permit. When the animal manure analysis indicates there are levels of arsenic, copper, zinc, or other constituents of concern, the Department shall establish constituent limits in permits for each constituent of concern to ensure the water quality standards of R.61-68 are maintained. For these cases the producer shall comply with the following criteria:

- a. Constituent Limits. If animal manure and other animal by-products subject to a constituent limit is applied to land, either:
 - i. The cumulative loading rate for each constituent shall not exceed the cumulative constituent loading rate for the constituent in Table 1 of Section 200.100; or
 - ii. The concentration of each constituent in the animal manure and other animal by-products shall not exceed the concentration for the constituent in Table 2 of Section 200.100.
- b. Constituent concentrations and loading rates - animal manure and other animal by-products.
 - i. Cumulative constituent loading rates.

TABLE 1 OF SECTION 200.100 - CUMULATIVE CONSTITUENT LOADING RATES		
Cumulative Constituent Loading Rate		
Constituent	(kilograms per hectare)	(pounds per acre)
Arsenic	41	37
Copper	1500	1339
Zinc	2800	2499

- ii. Constituent concentrations.

TABLE 2 OF SECTION 200.100 - CONSTITUENT CONCENTRATIONS	
Monthly Average Concentrations	
Constituent	Dry weight basis (milligrams per kilogram)
Arsenic	41
Copper	1500
Zinc	2800

- iii. Annual constituent loading rates.

TABLE 3 OF SECTION 200.100 - ANNUAL CONSTITUENT LOADING RATES		
Annual Constituent Loading Rate		
Constituent	(kilograms per hectare per 365-day period)	(pounds per acre per 365-day period)
Arsenic	2.0	1.8
Copper	75	67
Zinc	140	125

c. Additional constituent limits may be required, from the application information or subsequent monitoring in a permit thereafter, but such needs shall be assessed on an individual project basis.

d. Animal manure and other animal by-products shall not be applied subject to the cumulative constituent loading rates in Table 1 of Section 200.100.B.1 to land if any of the rates in Table 1 of Section 200.100.B.1 have been reached.

e. Animal manure and other animal by-products or animal lagoon sludge shall not be applied to land during a 365-day period after the annual application rate in Table 3 of Section 200.100.B.1 has been reached.

f. If animal manure and the animal by-products subject to the cumulative constituent loading rates in Table 1 of Section 200.100.B.1 have not been applied to the site, then cumulative rates apply.

g. If animal manure and other animal by-products subject to the cumulative constituent loading rates in Table 1 of Section 200.100.B.1 have been applied to the site and the cumulative amount of each constituent applied to the site in the animal manure and other animal by-products is known, the cumulative amount of each constituent applied to the site shall be used to determine the additional amount of each constituent that can be applied to the site in accordance with Section 200.100.B.1.a.i (cumulative loading rate shall not exceed the cumulative constituent loading rate).

h. Manure application shall not exceed the agronomic rate of application for plant available nitrogen (PAN) for the intended crop(s) on an annual basis. For those years that fertilizer is land applied, manures in combination with the fertilizer shall not exceed the agronomic rate of nutrient utilization of the intended crop(s).

2. Any producer who confines animals shall ensure that the applicable requirements in this part are met when the animal manure and other animal by-products are applied to the land.

3. Animal manure and other animal by-products shall not be applied to land that is saturated from recent precipitation, flooded, frozen, or snow-covered. Animal manure and other animal by-products shall not be applied during inclement weather or when a significant rain event is forecasted to occur within forty-eight (48) hours, unless approved by the Department in an emergency situation.

4. Animal manure and other animal by-products shall not be placed directly in groundwater.

5. All land application equipment, when used once or more per year, shall be calibrated at least annually by the person land applying. A permit may require more frequent calibrations to ensure proper application rates. The two (2) most recent calibration records should be retained by the producer and made available for Department review upon request. If the land application equipment has not been used in over a year, the equipment shall be calibrated prior to use.

6. Animal manure and other animal by-products shall not be applied to the land except in accordance with the requirements in this part.

7. A producer who supplies animal manure and other animal by-products to another person for land application shall provide the person who will land apply the manure and other animal by-products with the concentration of plant available nitrogen, phosphorus, potassium, and the concentration of all other constituents listed in the permit. The producer shall also supply the person who will land apply the manure with a copy of the crop management plan included in their Animal Facility Management Plan.

8. Animal manure and other animal by-products shall not be applied to or discharged onto a land surface when the vertical separation between the ground surface and the seasonal high water table is less than 1.5 feet at the time of application unless approved by the Department. For special cases, no land application can occur when the vertical separation from the ground surface to the water table is less than 1.5 feet at the time of application unless a situation is deemed an emergency with Departmental concurrence.

9. Soil sampling (usually 6 to 8 inch depth) shall be conducted for each field prior to manure application to determine the appropriate application rate. Each field should be sampled at least once

per year. If manure application frequency will be less than once per year, then at least one (1) soil sample shall be taken prior to returning to that field for land application. All new manure utilization areas shall be evaluated using the NRCS-CPS to determine the suitability for application and the limiting nutrient (nitrogen or phosphorus). However, fields that are high in phosphorus may also be required to incorporate additional runoff control or soil conservation features as directed by the Department. Additional soil sampling may be required by the Department on a case-by-case basis to ensure there is no potential for groundwater contamination.

10. Soil sampling to a depth of 18 inches may be required by the Department to be performed within forty-five (45) calendar days after each application of animal manure, but no more than two (2) times per year if the application frequency is more than twice per year. This sampling shall be performed for at least three (3) years after the initial application on at least one (1) representative manure utilization area for each crop grown to verify the estimated calculated manure application rates for the utilization areas. The date of manure application and the date of sampling shall be carefully recorded. The sampling shall be conducted at depths of 0 to 6 inches, 6 to 12 inches, and 12 to 18 inches with nitrates and phosphorus being analyzed.

11. The results of the pre-application and post-application sampling shall be used by the crop farmer to adjust as necessary, the amount of animal manure to be applied to a manure utilization area to meet the agronomic application rate for the crop(s) to be grown. These results shall be submitted to the Department at the time of application for permit renewal.

12. Additional soil sampling to greater depths may be required by the Department on a case-by-case basis to ensure there is no potential for groundwater contamination.

13. The permittee shall obtain the following information needed to comply with the requirements in this part:

a. Manure transfer contracts shall be developed for the producer to use with any person who is accepting manure in quantities greater than 12 tons per recipient per year. The contract should contain, at a minimum, the following information:

- i. Name, address, county, and telephone number of the person who is purchasing or accepting animal manure and other animal by-products;
- ii. Manure nutrient composition (pounds per ton of plant available nitrogen, phosphorus, and potassium to be filled in or provided by the producer. This information shall be obtained from three (3) manure analysis results and the producer shall provide this information on the manure transfer contract;
- iii. Land application field information;
- iv. Physical description (acreage, crop soil type);
- v. Soil test results (phosphorus, zinc, and copper in pounds/acre); and
- vi. Recommended application rates (nitrogen, phosphorus, and potassium in pounds/acre as reported on a soil test).

b. Attach a copy of a soils map, topographic map, county tax map, plat, FSA map, or a site plan sketch that includes the following information:

- i. Manure application areas with setbacks outlined;
- ii. Known water supply wells within 100 feet of property lines;
- iii. Adjacent surface waters, including ditches, streams, creeks, and ponds; and
- iv. Identification of roads and highways to indicate location.

c. Description of application equipment and name of person to land apply manure;

d. Signed agreement that informs the landowner that he or she is responsible and liable for land applying the animal manure and other animal by-products in accordance with this regulation; and

e. A copy of the land application requirements shall be provided to the recipient of the manure.

14. All persons who routinely accept manure from a producer, in quantities greater than 12 tons per recipient per year, shall be listed in the approved Animal Facility Management Plan. The Animal

Facility Management Plan shall include the appropriate manure utilization area information for the sites routinely used by other persons. The producer shall inform the applicator of their responsibility to properly manage the land application of manure to prevent discharge of pollutants to Waters of the State (including ephemeral and intermittent streams). A manure transfer contract must be signed. The person accepting the manure may be required by the Department to have an Animal Facility Management Plan and a permit for their manure utilization areas.

15. All persons who accept manure from a producer, in quantities less than 12 tons per recipient per year, are responsible for land applying the manure in accordance with this requirement and must have a signed agreement with the producer explaining their responsibility to comply with the regulation. The Department may require the person(s) land applying the manure to correct any problems that result from the application of manure.

16. Animal manure shall not be applied to cropland more than thirty (30) calendar days before planting or during dormant periods for perennial species, unless otherwise approved by the Department in an emergency situation.

17. If the Department receives complaints on a land application site, the Department may restrict land application of animal manure on this site completely or during certain time periods.

18. The Department may require manure to be disked in immediately.

19. Manure (solid or liquid) shall only be applied when weather and soil conditions are favorable and when prevailing winds are blowing away from nearby dwellings. Animal manure should not be applied to land when the soil is saturated, flooded, during rain events, or when a significant rain event is forecasted to occur within forty-eight (48) hours, unless otherwise approved by the Department in an emergency situation.

20. Manure shall not be spread in the floodplain if there is danger of a major runoff event, unless the manure is incorporated during application or immediately after application.

21. If the manure is stockpiled outside, the manure shall be stored on a concrete pad or other approved pad (such as plastic or clay lined) and covered with an acceptable cover to prevent odors, vector attraction, and runoff on a daily basis (unless otherwise specified in the permit). The cover should be properly vented with screen wire to let the gases escape. The edges of the cover should be properly anchored.

22. If a producer who contracts to transfer the animal manure and other animal by-products produced at their facility changes brokers/land applicators, he or she must submit notification and a new broker/land applicator contract for approval to the Department.

23. The body of vehicles transporting manure shall be wholly enclosed and, while in transit, be kept covered with a canvas cover provided with eyelets and rope tie-downs, or any other approved method which shall prevent blowing or spillage of loose material or liquids. Should any spillage occur during the transportation of the manure, the owner/operator shall take immediate steps to clean up the manure.

C. Setbacks for manure utilization areas.

1. The minimum separation distance required between a manure utilization area and a residence is 300 feet. If there are no residences within 300 feet of the manure utilization area, manure may be applied up to the property line. The 300-foot setback is waived with the consent of the owner of the residence. If the application method is injection or immediate incorporation, manure may be applied up to the property line. The setbacks are imposed at the time of application. The Department may impose these setbacks on previously approved sites to address problems on a case-by-case basis.

2. The minimum separation distance required between a manure utilization area and Waters of the State (including ephemeral and intermittent streams) located down slope from the area is 100 feet when spray application is the application method or when the manure is spread on the ground surface, 75 feet when incorporation is the application method, and 50 feet when injection is the application method. When incorporation is accomplished within twenty-four (24) hours of the initial application, the distance can be reduced to 50 feet.

3. The minimum separation distance required between a manure utilization area and ditches and swales, located down slope from the area, that discharge to Waters of the State including ephemeral and intermittent streams is 50 feet.

4. The minimum separation distance required between a manure utilization area and a potable drinking water well is 200 feet.

5. The Department may establish, in permits, additional application buffer setbacks for property boundaries, roadways, residential developments, dwellings, water wells, drainage ways, and surface water (including ephemeral and intermittent streams) as deemed necessary to protect public health and the environment. Factors taken into consideration in the establishment of additional setbacks would be animal manure application method, adjacent land usage, public access, aerosols, runoff prevention, adjacent groundwater usage, aquifer vulnerability, and potential for vectors and odors.

6. Water (pond) that is completely surrounded by land owned by the applicant and has no connection to surface water is excluded from the setback requirements outlined in this part.

D. The Department may establish additional permitting restrictions based upon soil and groundwater conditions to ensure protection of the groundwater and surface Waters of the State (including ephemeral and intermittent streams). Criteria may include, but is not limited to, soil permeability, clay content, depth to bedrock, rock outcroppings, aquifer vulnerability, proximity to a State Approved Source Water Protection Area, and depth to the seasonal high groundwater table.

E. The Department may establish permit conditions to require that animal manure and other animal by-products application rates remain consistent with the lime and fertilizer requirements for the cover, feed, food, and fiber crops based on Southeastern land grant universities' published lime and fertilizer recommendations, such as the Lime and Fertilizer Recommendations, Clemson Extension Services.

F. The Department may establish minimum requirements in permits for soil and/or groundwater monitoring, for manure utilization areas. Factors taken into consideration in the establishment of soil and groundwater monitoring shall include groundwater depth, operation flexibility, application frequency, type of animal manure and other animal by-products, size of manure utilization area, aquifer vulnerability, proximity to a State Approved Source Water Protection Area, and loading rate.

1. The Department may establish pre-application and post-application site monitoring requirements in permits for limiting nutrients or limiting constituents as determined by the Department.

2. The Department may establish permit conditions, which require the permittee to reduce, modify, or eliminate the animal manure and other animal by-products applications based on the results of this monitoring data.

3. The Department may modify, revoke and reissue, or revoke a permit based on the monitoring data.

G. The Department may require manure to be treated for odor control (i.e., composting or lime stabilizing for dry operations) prior to land application if the manure is not incorporated into the soil at the time of land application or if odors exist or are suspected to exist at an undesirable level. Manure, which has a very undesirable level of odor before treatment, such as turkey manure, shall not normally be permitted to be land applied on land near residences without appropriate treatment for odor control.

HISTORY: Amended by SCSR 45-5 Doc. No. 4997, eff May 28, 2021.

200.110. Spray Application System Requirements.

A. Spray application of liquid animal manure using irrigation equipment. This includes all methods of surface spray application, including, but not limited to, fixed gun application, traveling or mobile gun application, or center pivot application.

B. Manure utilization area slopes shall not exceed ten percent (10%) unless approved by the Department. The Department may require that slopes be less than ten percent (10%) based on site conditions.

C. Animal manure distribution systems shall be designed so that the distribution pattern optimizes uniform application.

D. Hydraulic Application Rates.

1. Application rates shall normally be based on the agronomic rate for the crop to be grown at the manure utilization area. As determined by soil conditions, the hydraulic application rate may be

reduced below the agronomic rate to ensure no surface ponding, runoff, or excessive nutrient migration to the groundwater occurs.

2. The hydraulic application rate may be limited based on constituent loading including any constituent required for monitoring under this regulation.

E. Animal manure and other animal by-products shall not be applied when the vertical separation between the ground surface and the seasonal high water table is less than 1.5 feet at the time of application, unless approved by the Department on a case-by-case basis. For special cases, no land application can occur when the vertical separation from the ground surface to the water table is less than 1.5 feet at the time of application unless a situation is deemed an emergency with Departmental concurrence.

F. Conservation measures, such as terracing, strip cropping, etc., may be required in specific areas determined by the Department as necessary to prevent potential surface runoff from entering or leaving the manure utilization areas. The Department may consider alternate methods of runoff controls that may be proposed by the applicant, such as berms.

G. For an animal facility, a system for monitoring the quality of groundwater may also be required for the proposed manure utilization areas. The location of all the monitoring wells shall be approved by the Department. The number of wells, constituents to be monitored, and the frequency of monitoring shall be determined on a case-by-case basis based upon the site conditions such as type of soils, depth of water table, aquifer vulnerability, proximity to State Approved Source Water Protection Area, etc.

H. If an adverse trend in groundwater quality is identified, further assessment and/or corrective action may be required. This may include an alteration to the permitted application rate or a cessation of manure application on the impacted area.

I. Spray application systems should be designed and operated in such a manner to prevent drift of liquid manure onto adjacent property.

HISTORY: Amended by SCSR 45-5 Doc. No. 4997, eff May 28, 2021.

200.120. Frequency of Monitoring for Animal Manure.

A. The producer and/or integrator shall be responsible for having representative samples, based on Clemson Extension Service recommendations, of the animal manure collected and analyzed at least once per year and/or when the feed composition significantly changes. The constituents to be monitored shall be given in the permit. The analyses should be used to determine the amount of animal manure to be land applied. In order to ensure that the permitted application rate (normally the agronomic rate) is met, the application amount shall be determined using a rolling average of the previous analyses. The Department shall establish minimum requirements for the proper method of sampling and analyzing of animal manure. Facilities with permits that do not specify which constituents to monitor shall monitor for Ammonium-Nitrogen, Total Kjeldahl Nitrogen (TKN), Organic Nitrogen (Organic Nitrogen = TKN - Ammonium Nitrogen), P_2O_5 , and K_2O .

B. The Department may require nitrogen, potassium, phosphorus, the constituents listed in Table 1 and Table 2 of Section 200.100, and any other constituent contained in a permit to be monitored prior to each application.

C. Permittees do not have to analyze for any constituent that they can demonstrate to the satisfaction of the Department is not present in their animal manure.

D. All monitoring shall be done in accordance with collection procedures in Standard Methods for Analysis of Water and Wastewater or other Department guidelines. Analysis shall be conducted by Clemson University Extension Service, or a laboratory certified by the Department. This laboratory shall have and maintain certification for the constituents to be analyzed.

HISTORY: Amended by SCSR 45-5 Doc. No. 4997, eff May 28, 2021.

200.130. Dead Animal Disposal Requirements.

A. Dead animal disposal shall be done as specified in the approved Animal Facility Management Plan. The Dead Animal Disposal Plan should include the following:

1. Primary Method for the handling and disposal of normal mortality at the facility.

2. Alternate Method for the handling and disposal of excessive mortality at the facility. The normal method of disposal may not be sufficient to handle an excessive mortality situation. Each producer shall have a Department-approved emergency or alternate method to dispose of excessive mortality. Excessive mortality burial sites shall be preapproved by the Department prior to utilization.

B. Burial.

1. Burial pits may be utilized for emergency conditions, as determined by the Department, when the primary method of disposal is not sufficient to handle excessive mortality.

2. Burial pits shall not be located in the 100-year floodplain.

3. Soil type shall be evaluated for leaching potential.

4. Burial pits shall not be located or utilized on sites that are in areas that may adversely impact surface or groundwater quality or further impact impaired water bodies.

5. The bottom of the burial pit may not be within 2 feet of the seasonal high groundwater table.

6. No burial site shall be allowed to flood with surface water.

7. Animals placed in a burial site shall be covered daily with sufficient cover (6 inches per day minimum) to prohibit exhumation by feral animals.

8. When full, the burial site should be properly capped (minimum 2 feet) and grassed to prohibit erosion.

9. Proposed burial pit sites shall be approved by the Department. The Department may conduct a geologic review of the proposed site prior to approval.

10. The Department may require any new or existing producer to utilize another method of dead animal disposal if burial is not managed according to the Dead Animal Disposal Plan or repeated violations of these burial requirements occur or adverse impact to surface or groundwater is determined to exist.

11. The Department may require groundwater monitoring for dead animal burial pits on a case-by-case basis. The Department shall consider all of the facts including, but not limited to, the following: depth to the seasonal high water table; aquifer vulnerability; proximity to a State Approved Source Water Protection Area; groundwater use in the area; distance to adjacent surface waters; number of dead animals buried; and frequency of burial in the area.

C. Incinerators.

1. For animal facilities proposing an incinerator for dead animal disposal, either a permit for the air emissions shall be obtained from the Department's Bureau of Air Quality before the incinerator can be built or the following criteria shall be met in order to qualify for an exemption from an air permit:

a. The emission of particulate matter shall be less than 1 pound per hour at the maximum rated capacity;

b. The incinerator shall be a package incinerator that meets the requirements from the Department's Bureau of Air Quality; and

c. The incinerator shall not exceed an opacity limit of ten percent (10%).

2. Incinerators used for dead animal disposal shall be properly operated and maintained. Operation shall be as specified in the owner's manual provided with the incinerator. The owner's manual shall be kept on site and made available to Department personnel upon request.

3. The use of the incinerator to dispose of waste oil, hazardous, or any other waste chemical is prohibited. The use of the incinerator shall be limited to dead animal disposal only unless otherwise approved by the Department's Bureau of Air Quality.

D. Composters. Composters used for dead animal disposal shall be designed by a professional engineer or an NRCS representative and operated in accordance with the approved Animal Facility Management Plan. Packaged composters shall be approved on a case-by-case basis.

E. Disposal of dead animals in a municipal solid waste landfill shall be in accordance with R.61-107.19.

F. Disposal of animal carcasses or body parts into manure lagoons, treatment systems, storage ponds, Waters of the State, ephemeral and intermittent streams, ditches, and swales is prohibited.

G. Disposal of animal carcasses or body parts by rendering shall be approved by the Department and include a signed contract with the rendering company.

H. Other methods of dead animal disposal that are not addressed in this regulation may be proposed in the Dead Animal Disposal Plan.

HISTORY: Amended by SCSR 45-5 Doc. No. 4997, eff May 28, 2021.

200.140. Other Requirements.

A. There shall be no discharge of pollutants from the operation into surface Waters of the State (including ephemeral and intermittent streams). There shall be no discharge of pollutants into groundwater, which could cause groundwater quality not to comply with the groundwater standards established in R.61-68.

B. On a case-by-case basis, the Department may impose additional or more stringent requirements for the management, handling, treatment, storage, or utilization of animal manure and other animal by-products.

C. The following cases shall be evaluated for additional or more stringent requirements:

1. Source water protection. Facilities and manure utilization areas located within a state-approved source water protection area.

2. 303(d) Impaired Water Bodies List. Facilities and manure utilization areas located upstream of an impaired waterbody.

3. Proximity to Outstanding Resource Waters, trout waters, shellfish waters, or potential to adversely affect a federally listed endangered or threatened species, its habitat, or a proposed or designated critical habitat.

4. Aquifer Vulnerability Area, an area where groundwater recharge may affect an aquifer.

D. If an adverse impact to the Waters of the State, including ephemeral and intermittent streams or groundwater, from animal manure and other animal by-products handling, storage, treatment, or utilization practices are documented, through monitoring levels exceeding the standards set forth in R.61-68, or a significant adverse trend occurs, the Department may require the producer responsible for the animal manure and other animal by-products to conduct an investigation to determine the extent of impact. The Department may require the producer to remediate the water to within acceptable levels as set forth in R.61-68.

E. No manure may be released from the premises of an animal facility to Waters of the State, including ephemeral and intermittent streams.

F. Animal medical waste cannot be disposed into animal lagoons, treatment systems, or manure storage ponds, or land applied with animal manure and other animal by-products.

G. In the event of a discharge from an animal facility or an animal lagoon, treatment system, or manure storage pond, the permittee is required to notify the Department immediately, within twenty-four (24) hours of the discharge.

H. When the Department determines that a nuisance exists at an animal facility, the permittee shall take action to correct the nuisance to the degree and within the time frame designated by the Department.

I. Permittees shall maintain all-weather access roads to their facilities at all times.

HISTORY: Amended by SCSR 45-5 Doc. No. 4997, eff May 28, 2021.

200.150. Odor Control Requirements.

A. The Animal Facility Management Plan shall contain an odor abatement plan for the animal facility, lagoon, treatment system, manure storage pond, and manure utilization areas, which shall consist of the following:

1. Operation and maintenance practices which are used to eliminate or minimize undesirable odor levels in the form of a Best Management Plan for Odor Control;

2. Use of treatment processes for the reduction of undesirable odor levels;
3. Other methods as may be appropriate; or
4. Any combination of these methods.

B. Producers shall utilize Best Management Practices normally associated with the proper operation and maintenance of an animal facility, lagoon, treatment system, manure storage pond, and any manure utilization area to ensure an undesirable level of odor does not exist.

C. No producer may cause, allow, or permit emission into the ambient air of any substance or combination of substances in quantities that an undesirable level of odor is determined to result unless preventive measures of the type set out below are taken to abate or control the emission to the satisfaction of the Department. When an odor problem comes to the attention of the Department through field surveillance or specific complaints, the Department shall determine if the odor is at an undesirable level.

D. If the Department determines an undesirable level of odor exists, the Department may require these abatement or control practices, including, but not limited to, the following:

1. Remove or dispose of odorous materials;
2. Methods in handling and storage of odorous materials that minimize emissions;
 - a. Dry manure to a moisture content of fifty percent (50%) or less;
 - b. Solids separation from liquid manure, and composting of solids;
 - c. Disinfection to kill microorganisms present in manure;
 - d. Aeration manure;
 - e. Composting of solid manure and other animal by-products; and/or
 - f. Odor control additives.
3. Prescribed standards in the maintenance of premises to reduce odorous emissions;
 - a. Filtration (biofilters or other filter used to remove dust and odor) of ventilation air;
 - b. Keep animals clean and separate from manure;
 - c. Adjust number of animals confined in the pens or paddocks in accordance with Clemson University Animal Space Guidelines.
 - d. Frequent manure removal from animal houses;
 - e. Feeding areas should be kept dry, and minimize waste feed accumulation;
 - f. Maintaining feedlot surfaces in a dry condition (twenty-five to forty percent (25 to 40%) moisture content), with effective dust control;
 - g. Proper maintenance of the dead animal disposal system;
 - h. Covering or reducing the surface area of manure and other animal by-products storage. (Vents shall be provided for the release of pressure created by manure gases if completely sealed covers are used);
 - i. Planting trees around or downwind of the manure and other animal by-products storage and treatment facilities (Trees shall not be planted within 25 feet of the toe of the dike.);
 - j. Incorporation of manure and other animal by-products immediately after land application; and/or
 - k. Selection of appropriate times for land application.
4. Best Available Technology to reduce odorous emissions.

E. Nothing in this section prohibits an individual or group of persons from bringing a complaint against a facility including problems at lagoons, treatment systems, manure storage ponds, and manure utilization areas.

F. If the permittee fails to control or abate the odor problems at an animal facility, lagoon, treatment system, manure storage pond, and any manure utilization area to the satisfaction and within a time frame determined by the Department, the permit may be revoked. If the permittee fails to control or abate the odor problems at land application sites, approval for land application of manure on the manure utilization area in question may be revoked. Additional land may be required to be

added to the Animal Facility Management Plan, if necessary, to provide a sufficient amount of land for manure utilization.

HISTORY: Amended by SCSR 45-5 Doc. No. 4997, eff May 28, 2021.

200.160. Vector Control Requirements.

A. The Vector Abatement Plan shall, at a minimum, consist of the following:

1. Best management practices used at the animal facility, lagoon, treatment system, manure storage pond, and manure utilization areas to ensure there is no accumulation of organic or inorganic materials to the extent and in such a manner as to create a harborage for rodents or other vectors that may be dangerous to public health.

2. A list of specific actions to be taken by the producer if vectors are identified as a problem at the animal facility, lagoon, treatment system, manure storage pond, or any manure utilization area. These actions should be listed for each vector problem, e.g., actions to be taken for fly problems, actions to be taken for rodent problems, etc.

B. No producer and or land applier may cause, allow, or permit vectors to breed or accumulate in quantities that result in a nuisance level, as determined by the Department.

C. For an existing facility, if the Department determines a vector problem exists, the Department may require these abatement of control practices, including, but not limited to, the following:

1. Remove and properly dispose of vector infested materials;
2. Methods in handling and storage of materials that minimize vector attraction;
 - a. Remove spilled or spoiled feed from the house as soon as practicably possible not to exceed forty-eight (48) hours, unless otherwise approved by the Department;
 - b. Remove and properly dispose of dead animals as soon as practicably possible not to exceed twenty-four (24) hours, unless otherwise approved by the Department;
 - c. Increase the frequency of manure removal from animal houses;
 - d. Prevent solids buildup in the pit storage or on the floors or walkways;
 - e. Remove excess manure packs along walls and curtains;
 - f. Compost solid manure and other animal by-products;
 - g. Appropriately use vector control chemicals, poisons, or insecticides (take caution to prevent insecticide resistance problems);
 - h. Utilize traps, or electrically charged devices;
 - i. Utilize biological agents;
 - j. Utilize Integrated Pest Management;
 - k. Incorporate manure and other animal by-products immediately (within twenty-four (24) hours) after land application; and/or
- l. Contact Clemson Extension Service for appropriate measures to control a vector problem.
3. Prescribed standards in the maintenance of premises to reduce vector attraction;
 - a. Remove standing water that may be a breeding area for vectors;
 - b. Keep animals clean or separated from manure;
 - c. Keep facility clean and free from trash or debris;
 - d. Properly utilize and service bait stations;
 - e. Keep feeding areas dry, and minimize waste feed accumulation;
 - f. Keep grass and weeds mowed around the facility and manure storage or treatment areas;
 - g. Properly maintain the dead animal disposal system;
 - h. Cover or reduce the surface area of manure and other animal by-products storage. (Vents shall be provided for release of pressure created by manure gases if completely sealed covers are used);
 - i. Properly store feed and feed supplements;

- j. Conduct a weekly vector monitoring program;
 - k. Be aware of insecticide resistance problems, and rotate use of different insecticides;
 - l. Prevent and repair leaks in waterers, water troughs, or cups; and/or
 - m. Ensure proper grading and drainage around the buildings to prevent rain water from entering the buildings or ponding around the buildings.
4. Utilize the best available control technology to reduce vector attraction and breeding.

HISTORY: Amended by SCSR 45-5 Doc. No. 4997, eff May 28, 2021.

200.170. Record Keeping.

A. A copy of the approved Animal Facility Management Plan, including approved updates, and a copy of the permit(s) issued to the producer shall be retained by the permittee for as long as the animal facility is in operation.

B. All application information submitted to the Department shall be retained by the permittee for eight (8) years. However, if the facility was permitted prior to June 26, 1998, and the permittee has previously discarded these documents since there was no requirement to maintain records at that time, this requirement shall not apply.

C. Records shall be developed for each manure utilization area. These records shall be kept for eight (8) years. The records shall include the following:

- 1. For each time animal manure and other animal by-products are applied to the site, the amount of animal manure and other animal by-products applied (in gallons per acre or pounds per acre, as appropriate), the date and time of application, and the location of application;
- 2. All sampling results for animal manure that is land applied;
- 3. All soil monitoring results;
- 4. All groundwater monitoring results, if applicable; and
- 5. Crops grown.

D. Records for the facility to include the following on a monthly basis:

- 1. Animal count and the normal production animal live weight; and
- 2. Mortality count and method of disposal.

E. Records for lagoon, treatment system, or manure storage pond operations to include the following:

- 1. Monthly water levels of the lagoon, treatment system, and manure storage pond; and
- 2. Groundwater monitoring results, if applicable.

F. All records retained by the producer shall be kept at either the facility, an appropriate business office, or other location as approved by the Department.

G. All records retained by the producer shall be made available to the Department during normal business hours for review and copying, upon request by the Department.

HISTORY: Amended by SCSR 45-5 Doc. No. 4997, eff May 28, 2021.

200.180. Reporting.

A. Large and X-large animal facilities are required to submit an annual report, on a form approved by the Department. The Department may establish reporting requirements in permits as it deems appropriate. These reporting requirements may include the following:

- 1. All manure sampling results for the last year and the latest rolling average concentration for the land limiting constituent;
- 2. All soil monitoring results, if applicable;
- 3. All groundwater monitoring results, if applicable;
- 4. Calculated application rates for all manure utilization areas; and

5. The adjusted application rates, if applicable, based on the most recent animal manure sampling, soil samples, and crop yield(s). The application rate change could also be due to a change in field use, crop grown, or other factors.
- B. The Department may require small animal facilities to submit annual reports on a case-by-case basis.
- C. The Department may establish permit conditions to require a facility to complete and submit a comprehensive report every five (5) years. The Department shall review this report to confirm that the permitted nutrient application rates have not been exceeded. Based on the results of the review, additional soil and/or groundwater monitoring requirements, permit modification, and/or corrective action may be required.

HISTORY: Amended by SCSR 45-5 Doc. No. 4997, eff May 28, 2021.

200.190. Training Requirements.

- A. An owner/operator of an animal facility or manure utilization area shall attend a training program on the operation of animal manure management under the program created and operated by Clemson University.
- B. Owners/Operators of new and existing animal facilities shall be required to obtain certification under the program created and operated by Clemson University.
- C. The certification program shall be completed by owners/operators of new facilities within one (1) year of the effective date of the issued permit.
- D. The certification program shall be completed by owners/operators of existing facilities within one (1) year of the effective date of this regulation.
- E. Certification shall be maintained as long as the facility remains in operation. All facilities must have a CAMM certified operator at all times.
- F. Failure to obtain the certification as provided in this Section shall be deemed a violation of this regulation and the permit may be revoked.
- G. An owner/operator of a cattle stockyard shall be exempt from attending the training program on the operation of animal manure management under the program created and operated by Clemson University (CAMM).

HISTORY: Amended by SCSR 45-5 Doc. No. 4997, eff May 28, 2021.

200.200. Violations.

- A. Persons who violate this regulation or any permit issued under this regulation are subject to the penalties in Sections 48-1-320 (Criminal Penalties) and 48-1-330 (Civil Penalties) of the South Carolina Pollution Control Act.
- B. Any person who falsifies, tampers with, or knowingly renders inaccurate any monitoring device or method required by the Department to be maintained as a condition in a permit, or who alters or falsifies the results obtained by such devices or methods, shall be deemed to have violated a permit condition and shall be subject to the penalties provided for pursuant to Sections 48-1-320 and 48-1-330 of the S.C. Code of Regulations.

HISTORY: Amended by SCSR 45-5 Doc. No. 4997, eff May 28, 2021.

PART 300

INNOVATIVE AND ALTERNATIVE TECHNOLOGIES

300.10. General.

- A. The Department supports and encourages the use of appropriate innovative and alternative technologies.
- B. When innovative or alternative technology is proposed for an agricultural facility for manure and other animal by-products handling, treatment, storage, processing, or utilization, a meeting should be held with the Department prior to the submittal of the project. The purpose of the meeting is for the applicant and the Department to go over the proposed project and the purpose and expected benefits from the use of the innovative or alternative technology.

HISTORY: Amended by SCSR 45-5 Doc. No. 4997, eff May 28, 2021.

300.20. Submittal Requirements.

A. When innovative or alternative technology is proposed for an agricultural facility for manure and other animal by-products handling, storage, treatment, processing, or utilization, the applicant shall provide to the Department the submittal information contained in Sections 100.50 or 200.50, as appropriate, and a detailed project report which explains the innovative or alternative technology and the purpose and expected benefits of the proposal.

HISTORY: Amended by SCSR 45-5 Doc. No. 4997, eff May 28, 2021.

300.30. Requirements in Lieu of Requirements Under Part 100 or Part 200 of This Regulation.

A. When the Department determines that appropriate alternative or innovative technology is being proposed, the specific requirements given in Part 100 and 200 of this regulation, which deal with the purpose or expected benefits of the technology, may not have to be met except when required by a specific statute or the Department after review of the project. Requirements in Part 100 that apply to X-large swine facilities shall not be reduced or waived.

B. The Department shall review the project and determine the purpose or benefits of the proposed innovative or alternative technology and determine which requirements under Part 100 or 200 do not have to be met and the appropriate requirements to be used in lieu of the requirements in Part 100 or 200.

C. When an alternative or innovative technology is proposed, the review criteria shall be established on a case-by-case basis by the Department when the project is received.

D. When alternative or innovative technology is utilized at an animal facility, the setbacks given in Part 100 or 200 may be reduced by the Department as appropriate. Requirements in Part 100 that apply to large or X-large swine facilities shall not be reduced or waived.

HISTORY: Amended by SCSR 45-5 Doc. No. 4997, eff May 28, 2021.

300.40. Innovative and Alternative Treatment Technologies.

A. The following is a list of innovative or alternative technologies for agricultural facilities to consider. This list is not exhaustive. Other processes exist and new technologies are being developed.

1. Aerobic treatment systems or combination aerobic/anaerobic systems;
2. Artificial (constructed) wetlands use for treatment;
3. Use of steel tanks;
4. Use of solid separators;
5. Methane Gas Recovery Systems;
6. Composting manure solids;
7. Bioreactors;
8. Covered liquid or slurry manure storage;
9. Air Scrubbers;
10. Ozonation; and
11. Alternative Fuels.

B. At a minimum, the preparer of the agricultural Animal Facility Management Plan should consider the technologies given in 300.40.A for use at a proposed agricultural facility when the Animal Facility Management Plan is being developed.

C. When odors exist or are reasonably expected to exist at an undesirable level, the Department may require the use of appropriate innovative or alternative treatment technology to eliminate the odors or the potential for odors.

D. When the Department determines under Section 100.70.G. (Permit Decision Making Process) that there is reasonable potential for cumulative or secondary impacts due to methane gas from

facilities, the Department may require the use of methane gas recovery systems or other appropriate technology to eliminate the potential impacts.

HISTORY: Amended by SCSR 45-5 Doc. No. 4997, eff May 28, 2021.

300.50. Exceptional Quality Compost.

A. When the Department determines that the composting of solid animal manure and other animal by-products is performed in such a manner that the odor and vector attraction potential is reduced and the controlled microbial degradation of the organic manure and other animal by-products has been accomplished, this material may be considered Exceptional Quality Compost. Exceptional Quality Compost may be sold or distributed without regulation by the Department, if it meets the requirements of this part and the standards established by Penn State University. The Department shall review and approve the composter design and proposal for operation and distribution of the composted product. Composting systems shall be designed by a professional engineer or an engineer with the Natural Resources Conservation Service.

B. Composting can be subject to nuisance problems such as odors, dusts, and vector attraction. Therefore, the composting facility shall incorporate measures to control such conditions. An Odor and Vector Abatement Plan shall be developed for a composting facility.

C. Compost Product Quality Standards.

1. Product Standards are necessary to protect public and environmental health and to ensure a measure of commercial acceptability.

a. Based on EPA standards for pathogen reduction, the time/temperature conditions required are equivalent to an average of 128 degrees Fahrenheit (°F) (53 degrees Celsius (°C)) for five (5) consecutive days, 131°F (55°C) for 2.6 consecutive days, or 158°F (70°C) for thirty (30) minutes.

b. The composted product shall meet or exceed the minimum standard of mature or very mature compost as set forth in the USDA Test Methods for the Examination of Composting and Compost (TMECC) Section 05.02-G CQCC Maturity Index. A maturity rating shall be given based upon the Maturity Assessment Matrix given in this method.

c. When land applied, the compost shall adhere to requirements for constituent concentrations and loading rates as outlined in Part 100.100, Part 200.100, or Part 400.60.

2. Compost products which meet these standards and also comply with pathogen quality and vector attraction standards are considered to be of Exceptional Quality and can be used without regulatory oversight, other than the compliance of agronomic application rates based on product analysis.

3. If the Department determines that the composting system is not being operated properly or that the composted product is not of an Exceptional Quality, the composted product shall be handled in accordance with the land application requirements of Part 100, 200, or 400 (as applicable) of this regulation.

4. An operable thermometer capable of measuring temperatures within a compost pile shall be kept at the composting facility for monitoring the temperature of each compost pile or batch. A written log of the daily temperature reading should be kept for each batch of compost. Temperatures shall not be allowed to rise above 180°F (82°C), which may cause combustion in the compost pile and start a fire.

5. The composted product shall be analyzed by Clemson University or another Department approved laboratory. The composted product content information along with recommended application rates shall be distributed with the product. The consumer shall be advised that the composted product shall be applied at an agronomic rate.

HISTORY: Amended by SCSR 45-5 Doc. No. 4997, eff May 28, 2021.

300.60. Public Notice Requirements.

When the Department permits an alternative or innovative technology, the notice on the issuance of the permit required under Sections 100.60.H. or 200.60.H. shall contain a general description of the innovative or alternative process and a summary of the expected benefits.

HISTORY: Amended by SCSR 45-5 Doc. No. 4997, eff May 28, 2021.

PART 400
MANURE BROKER/LAND APPLIER OPERATIONS

400.10. Purpose and Applicability.

A. Purpose.

1. To protect the environment and the health and welfare of citizens of the State from pollutants generated by the processing, treatment, and land application of dry animal manure and other animal by-products.

2. To establish standards, which consist of general requirements, constituent limits, management practices, and operational standards, for the use of dry animal manure and other animal by-products generated at animal facilities. Standards are included in this part for dry animal manure and other animal by-products applied to the land.

3. To establish standards for the frequency of monitoring and record keeping requirements for brokers/land appliers who operate dry animal manure and other animal by-products handling businesses.

4. To establish standards for the proper operation and maintenance of dry animal manure and other animal by-products treatment and storage facilities associated with manure brokering/land applying operations.

5. To establish criteria for dry animal manure and other animal by-products storage facilities' and manure utilization areas' locations as they relate to protection of the environment and public health. The location of dry animal manure and other animal by-products storage facilities and manure utilization areas as they relate to zoning in an area is not covered in this regulation. Local county or municipal governments may have zoning requirements and this regulation neither interferes with nor restricts such zoning requirements. Permit applicants should contact local municipal and county authorities to determine any local requirements that may be applicable.

B. Applicability.

1. This part applies to:

- a. All new and renewing dry manure brokering/land applying operations;
- b. All dry animal manure and other animal by-products treatment or storage facilities operated by brokers/land appliers; and
- c. Permanent manure utilization areas added to a manure broker/land applier management plan.

2. This part applies to all dry animal manure and other animal by-products taken, bought, given, handled, or sold by a manure broker.

3. This part applies to all land where dry animal manure and other animal by-products bought, given, taken, handled, or sold by a manure broker/land applier is applied.

4. This part applies to out-of-state and in-state based manure brokers/land appliers who accept manure and other animal by-products from agricultural animal facilities located in the State.

5. This part applies to all manure brokers/land appliers who bring animal manure and other animal by-products from other states into South Carolina.

6. Part 200.80.C. (Dry Animal manure and other animal by-products Treatment and Storage Facility Siting Requirements) of this regulation applies to dry animal manure and other animal by-products treatment or storage facilities proposed by brokers/land appliers.

7. If a manure broker/land applier proposes to handle, process, treat, or store liquid animal manure as a part of the operation, the requirements of this part shall be met, at a minimum. However, the Department may require that the applicant meet additional requirements applicable to liquid manure that are included in Part 100 and Part 200.

HISTORY: Amended by SCSR 45-5 Doc. No. 4997, eff May 28, 2021.

400.20. Permits and Compliance Period.

A. Permit Requirement. Animal manure and other animal by-products from an animal facility with dry manure handling can only be handled, stored, treated, processed, or land applied in the State in

accordance with a permit issued by the Department. The handling, storage, treatment, and final utilization of animal manure and other animal by-products from a manure broker/land applier operation shall be permitted under the provisions of this part before the broker/land applier can operate in the State.

B. Notification Requirements. The permittee shall notify the Department in writing and receive written Departmental approval, prior to any change in operational procedures in a permitted broker/land applier operation, including, but not limited to, the following:

1. Change in operations or in manure and other animal by-products treatment, storage, handling, or utilization;
2. Change in contracts routinely used in manure and other animal by-products transfers; or
3. Termination of operations.

HISTORY: Amended by SCSR 45-5 Doc. No. 4997, eff May 28, 2021.

400.30. Relationship to Other Regulations.

The following regulations are referenced throughout this part and may apply to facilities covered under this regulation.

A. Application and annual operating fees are addressed in R.61-30, Environmental Protection Fees.

B. The proper closeouts of wastewater treatment facilities are addressed in R.61-82, Proper Closeout of Wastewater Treatment Facilities. This regulation includes animal manure treatment lagoons and manure storage ponds.

C. Setbacks and construction specifications for potable water wells and monitoring wells shall be in accordance with R.61-71, Well Standards.

D. Permits for air emissions from incinerators are contained in R.61-62, Air Pollution Control Regulations and Standards.

E. Disposal of animal manure in a municipal solid waste landfill unit is addressed in R.61-107.19, Solid Waste Management: Solid Waste Landfills and Structural Fill.

F. Disposal of animal manure with domestic or industrial sludge is addressed in R.61-9, Water Pollution Control Permits, and permitted under R.61-9.

G. Laboratory certification is addressed in R.61-81, State Environmental Laboratory Certification Program.

H. Water Classifications and Standards are addressed in R.61-68.

HISTORY: Amended by SCSR 45-5 Doc. No. 4997, eff May 28, 2021.

400.40. Permit Application Procedures (Broker/Land Applier Management Plan Submission Requirements).

A. A person who proposes to operate as a broker/land applier shall submit an application for a permit under this part. The following information shall be included in the application package.

1. A complete application form provided by the Department.
2. A Broker/Land Applier Management Plan prepared by qualified Natural Resources Conservation Service personnel, an S.C. registered professional engineer, or other qualified individuals, such as certified soil scientists or S.C. registered professional geologists. The Broker/Land Applier Comprehensive Nutrient Management Plan shall, at a minimum, contain:
 - a. Brokering/land applying operation name, address, email, telephone number, county, and permit number (if applicable) and CAMM number (or if applicable, date of CAMM class);
 - b. Applicant's name, address, email, and telephone number (if different from above);
 - c. Broker's/land applier's name;
 - d. Dry Animal manure and other animal by-products Storage or Treatment Facility Information (if applicable):
 - i. Description of animal manure and other animal by-products storage and storage capacity;

- ii. Description of animal manure and other animal by-products treatment (if any);
 - iii. Facility location description and the zoning or land use restrictions in this area (this information should be obtained from the county). The minimum separation distance required between a dry animal manure and other animal by-products treatment or storage facility operated by a manure broker/land applier and the lot line of real property owned by another person is 200 feet and 1,000 feet to the nearest residence. However, the Department shall evaluate each proposed site to consider increasing distances, when the amount of manure stored, treated, or processed at this facility is significant.
 - e. Animal manure and other animal by-products handling and application information shall be included as follows:
 - i. A crop management plan which includes the optimum time of year of the animal manure and other animal by-products application and how it relates to crop type, crop planting, and harvesting schedule (if applicable) for manure utilization areas in the State. This information should be used as a guide in the absence of more accurate information. The Plan Preparer may need to include this information for the different regional areas of the State, as necessary, to provide the broker/land applier with crop information for the entire State;
 - ii. Type of equipment used to transport and/or spread the animal manure and other animal by-products;
 - iii. Description of services provided by the broker/land applier (clean-out houses, transport manure and other animal by-products, drop-off only, land application, incorporation of manure and other animal by-products into field, stacking or storing manure and other animal by-products, manure and other animal by-products treatment, etc.);
 - iv. Example of the contract or letter of intent to buy or accept animal manure and other animal by-products between the broker/land applier and the producer who is supplying the animal manure and other animal by-products; and
 - v. Example of the manure transfer contract to be used for the transfer of animal manure and other animal by-products between the broker and the person(s) who is accepting or purchasing the animal manure and other animal by-products. The Department has developed a Manure transfer contract that can be used or the broker may develop his own contract as long as it contains the minimum information outlined in part 400.60.B.12.
 - 3. The Broker/Land Applier Management Plan shall contain an odor abatement plan for the dry animal manure and other animal by-products storage or treatment facility or manure utilization areas, as appropriate.
 - 4. A Vector Abatement Plan shall be developed for the dry animal manure and other animal by-products storage or treatment facility or land application areas (if applicable).
 - 5. A soil monitoring plan shall be developed for all broker/land applier operations.
 - 6. Plans and specifications for the construction and operation of all manure and other animal by-products treatment or storage structures, such as composters or manure storage sheds that are to be owned and operated by the brokering/land applying operation.
 - 7. Adjoining property owners written agreement for reduction of setbacks for any manure storage and/or treatment facilities (if applicable).
 - 8. Application fee and first year's operating fee as established by R.61-30.
 - B. The Department may request an applicant to provide any additional information deemed necessary to complete or correct deficiencies in the broker/land applier operation permit application prior to processing the application or issuing, modifying, or denying a permit.
 - C. Applicants shall submit all required information in a format acceptable to the Department.
 - D. Incomplete submittal packages shall be returned to the applicant by the Department. An application package for a permit is complete when the Department receives all of the required information.
 - E. Application packages for permit modifications only need to contain the information applicable to the requested modification.

HISTORY: Amended by SCSR 45-5 Doc. No. 4997, eff May 28, 2021.

400.50. Permit Decision Making Process.

- A. No permit shall be issued before the Department receives a complete application for a permit.
- B. After the Department has received a complete application package, a technical review shall be conducted by the Department. The Department may request any additional information or clarification from the applicant or the preparer of the Broker/Land Applier Management Plan to help with the determination on whether a permit should be issued or denied. If a permit application package meets all applicable requirements of this part, a permit may be issued.
- C. A site inspection of any proposed sites for dry animal manure and other animal by-products storage or treatment facilities shall be made by the Department before a permit decision is made.
- D. For permit issuances, the Department shall publish a notice of issuance of a permit to operate a dry animal manure brokering operation on the Department's website.
- E. For permit denials, the Department shall give the permit applicant a written explanation, which outlines the specific reason(s) for the permit denial.
- F. When a permit is issued, it shall contain an issue date and an effective date. The effective date shall be at least fifteen (15) calendar days after the issue date to allow for any appeals. If a timely appeal is not received, the permit is effective.
- G. Permits issued under this part for broker/land applier operations shall be renewed every five (5) years. However, subsequent to the issuance of a permit, if the broker/land applier operation is not in operation or production for two (2) consecutive years, the permit is no longer valid and a new permit shall be obtained. If the Broker/Land Applier does not apply for permit renewal or does not fulfill the requirements of the permit renewal, the permit is terminated. Should the broker/land applier allow his or her permit to expire and apply for a new permit within the two (2) years, the broker/land applier will be required to update the management plan before the permit is re-issued.
- H. An expired broker/land applier operation permit which was issued under this part continues in effect until a new permit is effective only if the permittee submits a complete application, to the satisfaction of the Department, at least one hundred twenty (120) calendar days before the existing permit expires. The Department may grant permission to submit an application later than the deadline for submission stated above, but no later than the permit expiration date. If the facility has been closed for any two (2) consecutive years since the last permit was issued, the provision for the expiring permit remaining in effect does not apply since the permit is no longer valid. Permittees shall notify the Department in writing when they go out of business.
- I. At the time of the broker/land applier's renewal application, the Department shall review the yearly Animal Waste Balance Reporting Form, for every year of the current permit. The Department may request additional documentation based on the review of the Animal Waste Balance Reporting Form. The broker/land applier is required to add routine application sites to an updated management plan at the time of renewal. These manure utilization areas that are added to the broker management plan shall meet all the requirements for manure utilization areas included in Part 200 of this regulation.
- J. The brokering/land applying operation can only be built (if a manure storage or treatment facility was included) or operated when the permit is effective. The dry animal manure and other animal by-products treatment or storage facility cannot be placed into operation until the Department grants an ATO.
- K. For manure brokers/land appliers who do not have any constructed facilities associated with their operations, the Department shall issue a permit with an effective date. Once this permit is effective the broker/land applier may begin operations. No additional written approval from the Department shall be required.
- L. For manure brokers/land appliers who are permitted to construct a storage or treatment facility associated with the brokering/land applying operation, approval to begin operations shall be obtained prior to operation. To receive approval to begin operations, the broker/land applier shall have the preparer of the Broker/Land Applier Management Plan submit to the Department written certification that the construction of the dry animal manure and other animal by-products treatment or storage facility has been completed in accordance with the approved Broker/Land Applier Management Plan and the requirements of this regulation.

M. The Department shall conduct a final inspection of any dry animal manure and other animal by-products treatment or storage facilities before granting approval to a broker/land applier to begin operations (if applicable).

N. The Department shall grant written approval for the broker/land applier to begin operations of the dry animal manure and other animal by-products treatment or storage facility after it has received the certification statement in 400.50.M and the results of the final inspection, if conducted, are satisfactory.

HISTORY: Amended by SCSR 45-5 Doc. No. 4997, eff May 28, 2021.

400.60. Manure Utilization Area Requirements.

A. Application Rates. The Department shall approve a Broker/Land Applier Management Plan that establishes application rates based upon the limiting constituent (a nutrient or other constituent as given in item 400.60.B). The limiting constituent shall be nitrogen, unless the soil test results exceed the limits for phosphorus. More information on maximum allowable constituent concentrations are outlined in item 400.60.B and item 400.60.C.

B. Constituent Limits for Land Application of Dry Animal manure and other animal by-products and Operational Practices for Land Application.

1. Dry animal manure and other animal by-products. When the animal manure analysis indicates there are high levels of arsenic, copper, zinc, or other constituent of concern, the producer shall comply with the following criteria:

a. Constituent Limits. If animal manure and other animal by-products subject to a constituent limit is applied to land, either:

i. The cumulative loading rate for each constituent shall not exceed the loading rate in Table 1 of Section 400.60; or

ii. The concentration of each constituent in the animal manure and other animal by-products shall not exceed the concentration in Table 2 of Section 400.60.

b. Constituent concentrations and loading rates - animal manure and other animal by-products.

i. Cumulative constituent loading rates.

TABLE 1 OF SECTION 400.60 - CUMULATIVE CONSTITUENT LOADING RATES

Cumulative Constituent Loading Rate		
Constituent	(kilograms per hectare)	(pounds per acre)
Arsenic	41	37
Copper	1500	1339
Zinc	2800	2499

ii. Constituent concentrations.

TABLE 2 OF SECTION 400.60 - CONSTITUENT CONCENTRATIONS

Monthly Average Concentrations	
Constituent	Dry weight basis (milligrams per kilogram)
Arsenic	41
Copper	1500
Zinc	2800

iii. Annual constituent loading rates.

TABLE 3 OF SECTION 400.60 - ANNUAL CONSTITUENT LOADING RATES

Annual Constituent Loading Rate		
Constituent	(kilograms per hectare per 365-day period)	(pounds per acre per 365-day period)

Arsenic	2.0	1.8
Copper	75	67
Zinc	140	125

c. Additional constituent limits may be required, from the application information or subsequent monitoring in a permit thereafter, but such needs shall be assessed on an individual project basis.

d. No person shall apply animal manure and other animal by-products to land if any of the loading rates in Table 1 of Section 400.60.B.1 have been reached.

e. No person shall apply animal manure and other animal by-products to land during a 365-day period after the annual application rate in Table 3 of Section 400.60.B.1 has been reached.

f. If animal manure and other animal by-products have not been applied to the site, the cumulative amount for each constituent listed in Table 2 of Section 400.60.B.1 may be applied to the site in accordance with Section 400.60.B.1.a.i (cumulative loading rate shall not exceed the cumulative constituent loading rate).

g. If animal manure and other animal by-products have been applied to the site and the cumulative amount of each constituent applied to the site in the animal manure and other animal by-products is known, the cumulative amount of each constituent applied to the site shall be used to determine the additional amount of each constituent that can be applied to the site in accordance with Section 400.60.B.1.a.i (cumulative loading rate shall not exceed the cumulative constituent loading rate).

h. Manure application shall not exceed the agronomic rate of application for plant available nitrogen (PAN) for the intended crop(s) on an annual basis. For those years that fertilizer is land applied, manures in combination with the fertilizer shall not exceed the agronomic rate of nutrient utilization of the intended crop(s).

2. Any person who land applies animal manure and other animal by-products shall ensure that the applicable requirements in this part are met when the animal manure and other animal by-products are applied to the land.

3. If the Department receives complaints on a land application site, the Department may restrict land application of animal manure on this site completely or during certain time periods.

C. Requirements for the land application of animal manure and other animal by-products.

1. Manure (solid or liquid) shall only be applied when weather and soil conditions are favorable and when prevailing winds are blowing away from nearby dwellings. Animal manure and other animal by-products should not be applied to land when the soil is saturated, flooded, during rain events, or when a significant rain event is forecasted to occur within forty-eight (48) hours.

2. Animal manure and other animal by-products shall not be placed directly in groundwater.

3. Animal manure and other animal by-products shall not be applied to cropland more than thirty (30) calendar days before planting or during dormant periods for perennial species, unless otherwise approved by the Department in an emergency situation.

4. The land application equipment, when used once or more per year, shall be calibrated at least annually by the applicator. A permit may require more frequent calibrations to ensure proper application rates. The two (2) most recent calibration records should be retained by the broker/land applier and made available for Department review upon request. If the land application equipment has not been used in over a year, the equipment shall be calibrated prior to use.

5. If the broker chooses to offer manure analysis as a service, the manure shall be analyzed at least once per year. If the broker does not perform manure analysis, the animal producer shall provide the broker with a copy of the most recent manure analysis. Dry animal manure information (as appropriate) shall be included as follows:

a. Dry animal manure shall be analyzed for the following:

i. Nutrients (on a dry weight basis).

(a) Total Kjeldahl Nitrogen (mg/kg).

- (b) Total inorganic nitrogen (mg/kg).
 - (c) Total ammonia nitrogen (mg/kg) and Total nitrate, nitrogen (mg/kg).
 - (d) P₂O₅ (mg/kg).
 - (e) K₂O (mg/kg).
 - (f) Calcium Carbonate equivalency (if animal manure is alkaline stabilized).
- ii. Constituents (on a dry weight basis).
 - (a) Arsenic (mg/kg).
 - (b) Copper (mg/kg).
 - (c) Zinc (mg/kg).
- b. Name, address, email, and telephone number of the laboratory conducting the analyses.
 - c. Analysis shall be conducted by Clemson University Extension Service or a laboratory certified by the Department. This laboratory shall have and maintain certification for the constituents to be analyzed.
6. Permittees do not have to analyze for any constituent that they can demonstrate, to the satisfaction of the Department, is not present in their manure.
7. No person(s) accepting or purchasing manure or other animal by-products from a manure broker shall apply animal manure and other animal by-products to the land except in accordance with the requirements in this part. The broker shall inform the recipient of their responsibility to properly manage the land application of manure to prevent discharge of pollutants to Waters of the State (including ephemeral and intermittent streams) and ditches that lead to Waters of the State.
8. An animal producer who supplies animal manure to a broker/land applier shall provide the broker/land applier with the concentration of plant available nitrogen, phosphorus, potassium, and the concentration of all other constituents listed in the permit. If the broker/land applier is providing an additional service of collecting the manure samples to be analyzed, which shall be agreed upon up-front in the manure transfer contract, the analysis shall identify the name of the farm where the manure originated.
9. Animal manure and other animal by-products shall not be applied to or discharged onto a land surface when the vertical separation between the manure and other animal by-products and the seasonal water table is less than 1.5 feet at the time of application. For special cases, no land application can occur when the vertical separation from the ground surface to the water table is less than 1.5 feet at the time of application unless a situation is deemed an emergency with departmental concurrence.
10. Soil sampling (6–8 inches depth) shall be conducted for each field prior to manure application to determine the appropriate application rate. Each field should be sampled once per year. If manure application frequency will be less than once per year, at least one (1) soil sample should be taken prior to returning to that field for land application. This sample shall not be more than one (1) year old. All new manure utilization areas shall be evaluated using the NRCS-CPS to determine the suitability for application and the limiting nutrient (nitrogen or phosphorus). This information shall be obtained from person(s) accepting dry animal manure and other animal by-products prior to the delivery or land application of animal manure and other animal by-products by the broker/land applier. Soil phosphorus shall be addressed according to NRCS-CPS in the broker management plan. However, fields that are high in phosphorus may also be required to incorporate additional runoff control or soil conservation features as directed by the Department. The Department may require additional limits on soil phosphorus in the permit conditions. Additional soil sampling may be required by the Department on a case-by-case basis to ensure there is no potential for groundwater contamination.
11. The permittee shall obtain information needed to comply with the requirements in this part.
12. A Manure Transfer Contract shall be developed for the broker to use with any person who is accepting manure in quantities greater than 12 tons per recipient per year. The contract should contain, at a minimum, the following information:
- a. Name, address, email, county, and telephone number of the person who is purchasing or accepting animal manure and other animal by-products;

b. Name, address, email, CAMM number, county, and telephone number of the broker who is selling or providing animal manure and other animal by-products;

c. Manure nutrient composition (pounds per ton of plant available nitrogen, phosphorus, and potassium) to be filled in or provided by the broker/land applier. This information shall be obtained from the manure analysis results and the broker shall provide this information on the manure transfer contract;

d. Land Application Field Information:

i. Physical Description (acreage, crop, soil type);

ii. Soil Test Results (nitrogen, phosphorus, potassium, zinc, and copper in pounds/acre); and

iii. Recommended Application Rates (nitrogen, phosphorus, and potassium in pounds per acre as reported on a soil test).

e. Attach a copy of a soils map, topographic map, county tax map, plat, FSA map, or a site plan sketch which includes the following information:

i. Manure application area with setbacks outlined;

ii. Known water supply wells within 100 feet of the property line;

iii. Adjacent surface waters, including ditches, streams, creeks, and ponds; and

iv. Identification of roads and highways to indicate location.

f. Description of application equipment and name of person to land apply manure;

g. Signed agreement that informs the land owner/applier that he is responsible and liable for land applying the animal manure and other animal by-products in accordance with this regulation; and

h. A copy of the land application requirements shall be provided to the recipient of the manure.

13. All persons who routinely accept animal manure and other animal by-products, in quantities greater than 12 tons per recipient per year, from a broker shall be listed in the approved Broker Management Plan at the time of permit renewal. The Broker Management Plan shall include the appropriate manure utilization area information for the sites routinely used by other persons. The person accepting the manure may be required by the Department to have a Management Plan and a permit for their manure utilization areas.

14. Dead animals shall be removed from animal manure and other animal by-products prior to land application. The livestock producer is responsible for removing all dead animals from the manure prior to transfer. Manure brokers/land appliers may not accept manure that contains dead animals, unless the broker/land applier plans to separate out the dead animals and handle the dead animals in accordance with a dead animal disposal plan approved by the Department.

15. If the Department receives complaints on a land application site, the Department may restrict land application of animal manure on the site completely or during certain time periods.

16. The Department may require animal manure and other animal by-products, spread on cropland, to be disked in immediately.

17. Manure (solid or liquid) shall only be applied when weather and soil conditions are favorable and when prevailing winds are blowing away from nearby dwellings. Animal manure should not be applied to land when the soil is saturated, flooded, during rain events, or when a significant rain event is forecasted to occur within forty-eight (48) hours.

18. Any animal manure and other animal by-products that contain fly larvae and fly pupae shall be disked into the ground immediately or treated with an approved and effective fly control method. If the manure utilization on a land application area creates a fly problem for the community, the owner and/or applicator shall be responsible for the control of all flies resulting from the application of the manure. Assistance in fly control and fly problem prevention can be obtained through contact with the local Clemson Extension Service Office.

19. Animal manure and other animal by-products shall not be spread in the floodplain if there is danger of a major runoff event, unless the manure is incorporated during application or immediately after application.

20. If the manure is stockpiled outside, the manure shall be stored on a concrete pad and/or other approved pad and covered with an acceptable cover to prevent odors, vectors, and runoff on a daily basis (unless otherwise stated in the permit). The cover should be properly vented with screen wire to let the gases escape. The edges of the cover should be properly anchored.

21. Manure Brokers/Land Appliers and other manure transporters shall use all sanitary precautions in the collection, storage, transportation, and spreading of animal manure and other animal by-products. The body of all vehicles transporting manure shall be wholly enclosed, or shall at all times, while in transit, be kept covered with an appropriate cover provided with eyelets and rope tie-downs, or any other approved method which shall prevent blowing or spillage of loose material or liquids. Should any spillage occur during the transportation of the animal manure and other animal by-products, the owner/operator shall take immediate steps to clean up the animal manure and other animal by-products.

D. Setbacks for manure utilization areas.

1. The minimum separation distance required between a manure utilization area and a residence is 300 feet. If there are no residences within 300 feet of the manure utilization area, manure may be utilized up to the property line. The setback may be waived with the written consent of the owner of the residence. If the application method is injection or immediate incorporation (same day), manure can be utilized up to the property line.

2. The minimum separation distance required between a manure utilization area and Waters of the State (including ephemeral and intermittent streams) is 100 feet when dry manure is spread on the ground surface, 75 feet when incorporation is the application method, and 50 feet when injection is the application method. When incorporation is accomplished within twenty-four (24) hours of the initial application, the distance can be reduced to 50 feet.

3. The minimum separation distance required between a manure utilization area and ditches and swales that discharge to Waters of the State including ephemeral and intermittent streams is 50 feet.

4. The minimum separation distance required between a manure utilization area and a potable drinking water well is 200 feet.

5. The Department may establish additional application buffer setbacks for property boundaries, roadways, residential developments, dwellings, water wells, drainage ways, and surface water (including ephemeral and intermittent streams) as deemed necessary to protect public health and the environment. Factors taken into consideration in the establishment of additional setbacks would be animal manure application method, adjacent land usage, public access, aerosols, runoff prevention, adjacent groundwater usage, and potential for vectors and odors.

E. The Department may establish additional permitting restrictions based upon soil and groundwater conditions to ensure protection of the groundwater and surface Waters of the State (including ephemeral and intermittent streams). Criteria may include, but is not limited to, soil permeability, clay content, depth to bedrock, rock outcroppings, aquifer vulnerability, proximity to a State Approved Source Water Protection Area, and depth to the seasonal high groundwater table.

F. The Department may establish permit conditions to require that animal manure and other animal by-products application rates remain consistent with the lime and fertilizer requirements for the cover, feed, food, and fiber crops based on Southeastern land grant universities' published lime and fertilizer recommendations, such as the Lime and Fertilizer Recommendations, Clemson Extension Services.

G. The Department may establish minimum requirements in permits for soil and/or groundwater monitoring, for manure utilization areas. Factors taken into consideration in the establishment of soil and groundwater monitoring shall include groundwater depth, operation flexibility, application frequency, type of animal manure and other animal by-products, size of manure utilization area, aquifer vulnerability, proximity to a State Approved Source Water Protection Area, and loading rate.

1. The Department may establish pre-application and post-application site monitoring requirements in permits for limiting nutrients or limiting constituents as determined by the Department.

2. The Department may establish permit conditions, which require the permittee to reduce, modify, or eliminate the animal manure and other animal by-products applications based on the results of this monitoring data.

3. The Department may modify, revoke and reissue, or revoke a permit based on the monitoring data.

H. The Department may require manure to be treated for odor control (i.e., composting or lime stabilizing for dry operations) prior to land application if the manure is not incorporated into the soil at the time of land application or if odors exist or are suspected to exist at an undesirable level. Manure, which has a very undesirable level of odor before treatment, such as turkey manure, shall not normally be permitted to be land applied on land near residences without appropriate treatment for odor control.

HISTORY: Amended by SCSR 45-5 Doc. No. 4997, eff May 28, 2021.

400.70. Other Requirements.

A. On a case-by-case basis, the Department may impose additional or more stringent requirements for the management, handling, treatment, storage, or utilization of animal manure and other animal by-products.

B. The following cases shall be evaluated for additional or more stringent requirements:

1. Source water protection. Facilities and manure utilization areas located within a State Approved Source Water Protection Area.

2. 303(d) Impaired Waterbodies List. Facilities and manure utilization areas located upstream of an impaired waterbody.

3. Proximity to Outstanding Resource Waters, trout waters, shellfish waters, or would adversely affect a federally listed endangered or threatened species, its habitat, or a proposed or designated critical habitat.

4. Aquifer Vulnerability Area, an area where groundwater recharge may affect an aquifer.

C. If an adverse impact to the Waters of the State, including ephemeral and intermittent streams and groundwater, from animal manure and other animal by-products handling, storage, treatment, or utilization practices are documented, through monitoring levels exceeding the standards set forth in R.61-68 or a significant adverse trend occurs, the Department may require the person responsible for the animal manure and other animal by-products to conduct an investigation to determine the extent of impact. The Department may require the person to remediate the water to within acceptable levels as set forth in R.61-68.

D. Animal manure shall not be released to Waters of the State, including ephemeral and intermittent streams.

E. Animal medical waste shall not be land applied with animal manure and other animal by-products.

F. Animal manure and other animal by-products shall not be removed by a manure broker from a quarantined farm, until that quarantine has been lifted by the State Veterinarian.

G. Animal manure and other animal by-products that are quarantined for noxious weed seed contamination shall not be removed by a manure broker unless approved by Clemson Plant Industry.

H. If the Department determines that a complaint exists, the broker/land applier shall take action to correct the nuisance to the degree and within the time frame designated by the Department.

HISTORY: Amended by SCSR 45-5 Doc. No. 4997, eff May 28, 2021.

400.80. Odor Control Requirements.

A. An odor abatement plan shall be included, which may consist of the following:

1. Operation and maintenance practices which are used to eliminate or minimize undesirable odor levels in the form of a Best Management Plan for Odor Control;

2. Use of treatment processes for the reduction of undesirable odor levels;

3. Additional setbacks from property lines beyond the minimum setbacks given in this part;

4. Other methods as may be appropriate; or

5. Any combination of these methods.

B. Person(s) who transport, treat, store, or land apply manure and other animal by-products shall utilize Best Management Practices normally associated with the proper operation and maintenance of an animal manure and other animal by-products treatment or storage facility and any manure utilization area to ensure an undesirable level of odor does not exist.

C. No person(s) who transport, treat, store, or land apply manure and other animal by-products may cause, allow, or permit emission into the ambient air of any substance or combination of substances in quantities that an undesirable level of odor is determined to result unless preventive measures of the type set out below are taken to abate or control the emission to the satisfaction of the Department. When an odor problem comes to the attention of the Department through field surveillance or specific complaints, the Department shall determine if the odor is at an undesirable level.

D. If the Department determines an undesirable level of odor exists, the Department may require these abatement or control practices, including, but not limited to, the following:

1. Remove or dispose of odorous materials;
2. Methods in handling and storage of odorous materials that minimize emissions;
 - a. Dry manure to a moisture content of fifty percent (50%) or less;
 - b. Use disinfection to kill microorganisms present in manure;
 - c. Aerate manure;
 - d. Compost solid manure and other animal by-products; and/or
 - e. Utilize odor control additives.
3. Prescribed standards in the maintenance of premises to reduce odorous emissions;
 - a. Cover or reduce the surface area of manure and other animal by-products storage. (Vents shall be provided for release of pressure created by manure gases if completely sealed covers are utilized);
 - b. Plant trees around or downwind of the manure and other animal by-products storage and treatment facilities;
 - c. Incorporate manure and other animal by-products immediately, within twenty-four (24) hours after land application;
 - d. Select appropriate times for land application.
4. Best available control technology to reduce odorous emissions.

E. If the permittee fails to control or abate the odor problems at a land application site to the satisfaction and within a time frame determined by the Department, the broker permit may be revoked. If the permittee fails to control or abate the odor problems at land application sites, approval for land application of manure on the manure utilization area in question may be revoked. Additional land may be required to be added to the broker management plan, if necessary to provide a sufficient amount of land for manure utilization.

HISTORY: Amended by SCSR 45-5 Doc. No. 4997, eff May 28, 2021.

400.90. Vector Control Requirements.

A. A Vector Abatement Plan shall be developed for the dry animal manure and other animal by-products storage or treatment facility or land application areas (if applicable). The Vector Abatement Plan shall, at a minimum, consist of the following:

1. Normal management practices used at the dry animal manure and other animal by-products storage or treatment facility to ensure there is no accumulation of organic or inorganic materials to the extent and in such a manner as to create a harborage for rodents or other vectors that may be dangerous to public health.
2. A list of specific actions to be taken by the broker/land applier if vectors are identified as a problem at the dry animal manure and other animal by-products storage or treatment facility or land application site. These actions should be listed for each vector problem, e.g., actions to be taken for fly problems, actions to be taken for rodent problems, etc.

3. If the broker is not performing land application, but is only transferring the manure to a person who is accepting responsibility for handling the manure in accordance with this regulation, the person accepting the manure shall be responsible for correcting any nuisance problems resulting from the land application of manure.
- B. No broker/land applier may cause, allow, or permit vectors to breed or accumulate in quantities that result in a nuisance level, as determined by the Department.
- C. For an existing broker/land applier, if the Department determines a vector problem exists, the Department may require these abatement or control practices, including, but not limited to, the following:
 1. Remove and properly dispose of vector infested materials;
 2. Methods in handling and storage of materials that minimize vector attraction;
 - a. Compost solid manure;
 - b. Appropriately use vector control chemicals, poisons, or insecticides (take caution to prevent insecticide resistance problems);
 - c. Utilize traps, or electrically charged devices;
 - d. Utilize biological agents;
 - e. Utilize Integrated Pest Management; and/or
 - f. Incorporate manure and other animal by-products immediately, within twenty-four (24) hours after land application.
 3. Prescribed standards in the maintenance of premises to reduce vector attraction;
 - a. Remove any standing water that may be a breeding area for vectors;
 - b. Keep storage and/or treatment facilities clean and free from trash or debris;
 - c. Properly use and service bait stations;
 - d. Keep grass and weeds mowed around the manure storage and/or treatment areas;
 - e. Cover or reduce the surface area of manure and other animal by-products storage. (Vents shall be provided for release of pressure created by manure gases if completely sealed covers are used);
 - f. Conduct a weekly vector monitoring program;
 - g. Be aware of insecticide resistance problems, and rotate use of different insecticides; and/or
 - h. Ensure proper grading and drainage around the buildings to prevent rain water from entering the buildings or ponding around the buildings.
 4. Utilize the best available control technology to reduce vector attraction and breeding.

HISTORY: Amended by SCSR 45-5 Doc. No. 4997, eff May 28, 2021.

400.100. Record Keeping.

- A. A copy of the approved Broker/Land Applier Management Plan, including approved updates, and a copy of the permit(s) issued to the broker/land applier shall be retained by the permittee for as long as the broker is in operation.
- B. All application information submitted to the Department shall be retained by the permittee for eight (8) years.
- C. Animal Manure Records. These records shall be kept for five (5) years. The records shall include the following:
 1. Name, address, email, county, and phone number of all producers from whom the broker/land applier purchases or accepts animal manure;
 2. Sampling results for the animal manure;
 3. Amount (in tons) of animal manure obtained from each producer; and
 4. Date of transfer.
- D. All completed Manure Transfer contracts, including soil analysis results, between the broker and the person(s) purchasing or accepting animal manure, shall be kept by the broker for eight (8) years.

E. All records retained by the broker/land applier shall be kept at an appropriate business office, or other location, as approved by the Department.

F. All records retained by the broker/land applier shall be made available to the Department during normal business hours for review and copying, upon request by the Department.

HISTORY: Amended by SCSR 45-5 Doc. No. 4997, eff May 28, 2021.

400.110. Reporting.

A. The Department may establish reporting requirements in permits as it deems appropriate. These reporting requirements may include a

Manure Balance Sheet, which lists the producer/farm name and amount (tons) of manure provided and a listing of all person(s) who bought or accepted animal manure and the amount (tons) accepted. Any manure that is currently in storage or treatment structures at the broker/land applier facility shall be accounted for in this report.

B. The Department may require on a case-by-case basis any of the required records, as outlined in section 400.100, to be reported on an annual basis.

HISTORY: Amended by SCSR 45-5 Doc. No. 4997, eff May 28, 2021.

400.120. Training Requirements.

A. An owner/operator of a manure brokering/land applying business shall be trained and certified on the operation of animal manure management under the poultry version of the certification program created and operated by Clemson University (CAMM). The certification shall be obtained within one (1) year of the effective date of the issued permit.

B. The certification program shall be completed by owners/operators of existing brokerage/land applier businesses within one (1) year of the effective date of this regulation or of a transfer of ownership approval.

C. Failure to obtain the certification and education as provided in this Section shall be deemed a violation of this regulation and a violation of the permit.

HISTORY: Amended by SCSR 45-5 Doc. No. 4997, eff May 28, 2021.

400.130. Violations.

Persons who violate this regulation or any permit issued under this regulation are subject to the penalties in Sections 48-1-320 (Criminal Penalties) and 48-1-330 (Civil Penalties) of the South Carolina Pollution Control Act.

HISTORY: Amended by SCSR 45-5 Doc. No. 4997, eff May 28, 2021.

PART 500 INTEGRATOR REGISTRATION PROGRAM

500.10. General.

A. The Department encourages Integrators to be involved with the permitting and compliance of their growers.

B. The Department encourages Integrators to assist growers in the disposal of dead animals and the proper utilization of animal manure.

C. Integrating companies shall inform each prospective grower that they are required by State law to obtain a permit to construct and an approval to operate from the Department, and a certification of construction from the engineering company or NRCS. The Department recommends that growers verify an exemption status from the Department prior to construction of an agricultural animal facility.

HISTORY: Amended by SCSR 45-5 Doc. No. 4997, eff May 28, 2021.

500.20. Submittal Requirements.

A. Each integrating company that contracts with animal producers that operate facilities located within the State shall submit to the Department a Request for Registration form, as provided by the Department. The Integrator shall work with the Department to identify growers that are unpermitted.

The Department may schedule an annual inspection in order to review grower lists and identify unpermitted farms. The integrator shall provide the Department any additional information needed to contact unpermitted growers contracting with their company.

B. Animal Manure Analysis Information. If the producers that contract with the integrator use the same feed rations and have dry animal manure analyses that come out to be consistently the same, they may qualify to use one (1) analysis for their individual testing requirement. However, if any of these producers utilize a different feed ration, utilize a significant amount of medications as compared to the others, or use any other inconsistent bedding materials, animal manure treatments, or vector treatments, they shall be required to run a separate and individual analysis on their animal manure. The Integrator is responsible for notifying the Department of any significant feed composition changes. This benefit shall not be available to liquid manure handling systems, since other factors specific to each site, such as rainfall, could affect the nutrient analysis of the manure.

C. If an integrating company can certify through general feed composition reports that a certain constituent, such as arsenic, is not present in their feed or medications, the producers that contract with that integrator may be exempt from testing for that constituent. The integrator shall submit a written request, along with general feed composition reports, and a list of growers who are using this feed ration. The Department shall approve this report in writing before the constituent can be removed from the analysis requirements. Each grower who is included in this exemption shall be notified in writing by the Department.

D. Swine Integrators must submit a plan addressing cumulative environmental and public health impacts of their contracted facilities with their first request for integrator certification. The plan must cover the integrator's existing contract growers and the projected three (3) year increase in the number of permitted facilities and swine. The plan must include:

1. The general area served by the integrator;
2. The number of existing swine facilities under contract;
3. The number of swine grown (broken down by facility);
4. The number of projected new facilities (broken down by facility size) with the total number of swine;
5. The integrating company's: procedures, protocols, policies, programs, required manure treatment and utilization technologies, etc. to ensure the cumulative impacts from their contracted facilities do not cause any adverse impact to the environment or public health; and
6. An assessment of the adverse environmental or public impact, if any, from the existing and proposed swine facilities under contract with the integrator.
7. The Swine Integrator must also provide to the Department any other supplemental information that may reasonably be required by the Department to assess cumulative adverse environmental or public health impacts.
8. The environmental and public health impact assessment plan must be approved by the Department before integrator certification can be granted. Once approved, the integrator may update the plan at any time. Also, the Department may require the plan be updated from time to time.

E. All permits for growers under contract with the integrator must be in accordance with the integrator's approved plan.

F. All integrators are required to submit, on an annual basis by December 31st of each year, a list of active and inactive growers that have been added and/or released from their contracts.

HISTORY: Amended by SCSR 45-5 Doc. No. 4997, eff May 28, 2021.

500.30. Certificate of Integrator Registration.

A. The Department shall issue a certificate of integrator registration to integrators or integrating companies that meet all the requirements of this part.

B. All integrators or integrating companies shall hold a valid certificate of registration to operate in the State.

C. Certificates of integrator registration issued under this part do not have any administrative procedures for public notice under this regulation.

D. The certificate of integrator registration may be modified, revoked, or reissued if the requirements of this part are not met by the integrator or integrating company.

HISTORY: Amended by SCSR 45-5 Doc. No. 4997, eff May 28, 2021.

500.40. Reporting.

A. The Department may establish reporting requirements for integrators as it deems appropriate. These reporting requirements may include the following:

1. General feed composition reports. Feed composition reports provided in accordance with this section shall be exempt from disclosure under the Freedom of Information Act; and
2. A list of any special treatments or chemicals added to the manure or manure storage structure that are required by the integrator.

HISTORY: Amended by SCSR 45-5 Doc. No. 4997, eff May 28, 2021.

500.50. Other Requirements.

A. An integrator or integrating company shall not knowingly provide animals to an animal facility that does not hold a valid agricultural permit and an approval to operate from the Department. Any existing, unexpired contracts may be fulfilled, but the integrator may not renew the contract until the facility has obtained a valid permit and approval to operate. If an integrator knowingly provides animals to an animal facility that does not hold a valid permit, the Department may require the integrator to remove the animals from the facility and be subject to Part 500.60.

B. The integrator or integrating company shall take reasonable steps to ensure that the animal facilities that are under contract with the company are certified, trained, and educated on compliance with their permit to include the following:

1. Notify growers of their responsibility to update their Animal Facility Management Plan and permit if changes are made in the operation of the farm; and
2. Provide information on technical assistance to its growers on compliance and assist the producers in selecting a corrective action.

HISTORY: Amended by SCSR 45-5 Doc. No. 4997, eff May 28, 2021.

500.60. Violations.

Persons who violate this regulation or any permit issued under this regulation are subject to the penalties in Sections 48-1-320 (Criminal Penalties) and 48-1-330 (Civil Penalties) of the South Carolina Pollution Control Act.

HISTORY: Amended by SCSR 45-5 Doc. No. 4997, eff May 28, 2021.

PART 600. Severability

Should a section, paragraph, sentence, clause, phrase, or other part of this regulation be declared invalid for any reason, the remainder shall not be affected.

HISTORY: Added by State Register Volume 22, Issue No. 6, Part 2, eff June 26, 1998. Amended by State Register Volume 26, Issue No. 6, Part 2, eff June 28, 2002; SCSR 45-5 Doc. No. 4997, eff May 28, 2021.

61-44. Individual Residential Well and Irrigation Well Permitting.

(Statutory Authority: 1976 Code §§ 48-1-10 et seq. and 44-55-10 et seq.)

Table of Contents

- A. Purpose and Scope.
- B. Definitions.
- C. General.
- D. Notice of Intent, Permit, and Approval.
- E. Emergency Well Replacement.
- F. General Permit Fee.
- G. Reference.

- H. Enforcement.
- I. Violations, Penalties.
- J. Severability.

A. PURPOSE AND SCOPE.

1. This regulation, promulgated pursuant to the authority of the Pollution Control Act, Section 48-1-10 *et seq.*, and the Safe Drinking Water Act, Section 44-55-10 *et seq.*, 1976 S.C. Code of Laws, establishes a system and rules for managing and protecting the quality of South Carolina's groundwater, drinking water, and for protection of public health.

2. The South Carolina Department of Health and Environmental Control has concluded that the improper installation of individual residential wells and irrigation wells are endangering public health and the quality of groundwater in this state and therefore finds the need for regulation to govern installation of such wells.

B. DEFINITIONS. The definition of any word or phrase employed in this regulation shall be the same as given in the Well Standards, R.61-71, Pollution Control Act, 48-1-10 *et seq.*, and the Safe Drinking Water Act, Section 44-55-10 *et seq.*, 1976 S.C. Code of Laws. Words or phrases which are not defined in the Acts or Regulations are defined as follows:

- 1. Agent- a person acting on behalf of an owner, subject to the control of the owner, who acts in such a manner as to affect the legal relationships of the owner with third parties.
- 2. General Permit - a permit for the construction of individual residential wells or irrigation wells issued under this regulation authorizing a category of well construction activities within the state.
- 3. Human Consumption - water used for drinking, bathing, cooking, dishwashing and maintaining oral hygiene, or other similar uses.
- 4. Individual Residential Well - a potable water well intended to produce water for human consumption at a single residence or family.
- 5. Irrigation Well - a well intended to produce water for uses other than human consumption, to include, but not be limited to, lawn and landscape watering and agricultural uses.
- 6. Owner - a property owner where the well is to be constructed.
- 7. Replacement Well - a well being constructed to take the place of an existing individual residential well or irrigation well that is being taken out of service.
- 8. Residence - legal residence; the permanent, fixed place of abode which a person intends to be his residence and to which he intends to return.
- 9. Well driller - an individual, corporation, partnership, association, political subdivision, or public agency of this State who is licensed with the S.C. Department of Labor, Licensing, and Regulation for constructing wells and is in immediate supervision of, and responsible for, the construction, development, drilling, testing, maintenance, repair, or abandonment of any well as defined by this regulation. This term shall include owners constructing or abandoning wells on their own property for their own personal use only, except that such owners are not required to be licensed by the Department of Labor, Licensing, and Regulation for constructing wells and are not subject to the bonding requirements of subsection (C)(4) of this regulation.

C. GENERAL.

1. Individual residential wells and irrigation wells shall be constructed or abandoned by well drillers who are licensed for such purposes by the S.C. Department of Labor, Licensing, and Regulation. The licensing required by the subsection does not apply to owners constructing or abandoning wells on their own property for their own personal use only.

2. All individual residential wells and irrigation wells shall be constructed or abandoned in accordance with this regulation, Regulation 61-71, Well Standards, and all other applicable laws, regulations, and standards.

3. The Department must conduct necessary inspections, to the maximum extent as resources allow, to ensure compliance with the provisions of this regulation. The owner shall grant access to the well construction site to the Department at reasonable times for the purpose of conducting such inspections. The inspection program will primarily be conducted by Department personnel located in the District Environmental Quality Control offices. Inspections shall be conducted at the time of construction

when possible. The purpose of inspections is to determine compliance with the Well Standards R.61-71 and this regulation. The inspections shall include, at a minimum, determining: 1) proof of coverage under the general permit, 2) compliance with siting requirements, 3) the presence or absence of an adequate grout seal and compliance with other critical construction standards outlined in R.61-71, and 4) eventual timely submittal of the well record form. Violations of the cited regulations noted during the inspection shall result in enforcement action in accordance with established Department procedures. The Department shall develop an inspection manual which outlines the complete inspection process for Department personnel in accordance with the requirements of this regulation and the Well Standards R.61-71. Interested parties may provide input into development and annual updating of the inspection manual. After one year's training and experience, each district well inspector shall conduct a minimum of 200 inspections annually of individual residential or irrigation wells with a Department goal to inspect a majority of wells constructed under this regulation. Owners shall be provided a copy of the Department's inspection results.

4. The Department shall prepare an annual report detailing activities funded by individual residential well and irrigation well fees including the number of wells issued coverage under the general permit, number of inspections, inspection results, fees collected, and number of enforcement actions. This report shall be submitted to the South Carolina Legislature and the South Carolina Groundwater Association and be available for the general public.

5. Each well driller must meet bonding requirements as established by the Department of Labor, Licensing, and Regulation. The Department shall have full access to a well driller's bond to correct a violation of this regulation and/or Regulation 61-71, Well Standards, where, as part of a Department enforcement action, a well driller is unwilling or unable to take required corrective actions. The bonding provisions required by the subsection does not apply to owners constructing or abandoning wells on their own property for their own personal use only.

6. Irrigation wells shall not be permitted at a residence unless another source of potable water serving the residence is proposed or exists.

7. The Department is authorized to develop a "General Permit" for individual residential well and irrigation well activities.

8. This regulation will become effective 60 days after Legislative approval.

D. NOTICE OF INTENT, PERMIT, AND APPROVAL.

1. It shall be unlawful to construct an individual residential well, an irrigation well, or a replacement well unless conditions of the general permit issued by the Department have been satisfied for the construction of the proposed well.

2. It shall be the responsibility of the well driller to ensure that coverage under this general permit to construct an individual residential well, irrigation well, or replacement well is obtained from the Department prior to construction of the well.

3. It shall be the responsibility of the well driller to ensure that all wells permitted under this regulation are located and constructed in accordance with all applicable regulations.

4. A Notice of Intent (NOI) form provided by the Department, as specified in the general permit, must be submitted to the Department with true and accurate information necessary for determining the location of, and proper construction of, individual residential wells, replacement wells, and irrigation wells. The NOI may be submitted by the owner, agent, or well driller. This information shall include, but may not be limited to, owner name, address, and telephone number, address of the property on which the well is to be installed, proposed date of installation, proposed well location, if the proposed well is a new well or replacement well, and name and license number of the licensed well driller constructing the well. If any information provided on the NOI changes at the time of well construction, the well driller must contact the Department and provide the correct information.

5. Upon receipt of a completed NOI, the Department shall accomplish its review and have either the approval, review comments, or denial transmitted to the applicant within 48 hours. The 48 hour period is calculated from the time and date of receipt of the Notice of Intent excluding weekends and legal state holidays. If notice is not given to the applicant by the end of the 48 hour period, coverage under the general permit for individual residential wells and irrigation wells will be considered approved. The well driller shall also give the Department 48 hours prior notice of well installation with the exact date, time, and location of well installation. This notice can be concurrent with the NOI

review period. The Department shall deny coverage under the general permit when the proposed well would violate Regulation 61–71, Well Standards, the Pollution Control Act, Section 48–1–10 *et seq.*, the Safe Drinking Water Act, Section 44–55–10 *et seq.*, 1976 S.C. Code of Laws, or licensing requirements established by the S.C. Department of Labor, Licensing, and Regulation. Nothing in this regulation shall be used to limit construction of individual residential wells or irrigation wells that are constructed in accordance with the applicable regulations cited above. The Department inspectors will utilize available resources, such as Department records of permits for onsite wastewater systems and subdivision application approvals, to help determine compliance with the NOI provisions in this regulation.

6. Coverage under a general permit issued pursuant to this regulation shall not guarantee that a well will yield water that is of adequate quality and/or quantity for the purposes intended.

7. The well driller shall have a copy of the Notice of Intent before initiating construction of an irrigation well or individual residential well and shall keep a copy of the Notice of Intent on the drilling site at all times.

E. EMERGENCY WELL REPLACEMENT. A well driller may replace an existing individual residential well immediately when an emergency exists. An emergency is deemed to exist when an existing individual residential well has suddenly been rendered useless or the water quality is not fit for human consumption and a replacement well is needed to provide a potable water supply. The Notice of Intent and associated fee shall be submitted within 24 hours of well construction.

F. GENERAL PERMIT FEE.

1. Each well driller, owner, or agent applying for a general permit to construct a new or replacement individual residential well or irrigation well shall pay to the Department a fee in accordance with Regulation 61–30, Environmental Protection Fees.

2. Upon notification of the Department, no permit fee shall be assessed to a well driller, owner, or agent who has replaced, within one year of installation, an unserviceable or otherwise unsatisfactory individual residential well or irrigation well if the unserviceable or unsatisfactory well is properly abandoned.

3. The fee collected must be returned to the Department for the sole purpose of developing and implementing the Individual Residential Well and Irrigation Well Program, including proposed well construction review, compliance inspections, technical assistance, enforcement, and for providing bacteriological analytical services for new individual residential wells.

G. REFERENCE. The definitions and standards established by Regulation 61–71, Well Standards, are herein adopted by reference.

H. ENFORCEMENT. For the purpose of enforcing this regulation, an employee or duly authorized representative of the Department may enter at reasonable times the site of well construction on the property of an owner where a permit has been obtained pursuant to this regulation. The Department, upon receipt of information that a constructed individual residential well or irrigation well may present an unacceptable risk to health of the persons using the well or to the groundwaters of the State, or is in violation of any other applicable statutes or regulations, will initiate enforcement action against the well driller.

I. VIOLATIONS; PENALTIES.

1. Violations of this regulation shall be subject to penalties as provided in Sections 48–1–320, 44–55–90 and 48–1–330 of the 1976 S.C. Code of Laws.

2. Whenever the Department finds that a well driller is in violation of a permit, regulation, standard, or requirement under this regulation, the Department, after written notice of violation, may issue an order requiring the well driller to comply with the permit, regulation, standard, or requirement, or may request the Attorney General to commence an action under this subsection in the appropriate court. The Department may also assess civil penalties as provided in this section for violations of the provisions of this regulation including any order, permit, regulation, or standard.

3. A well driller who fails to take appropriate corrective action, after receiving written notice of violation of a provision of this regulation, is liable for civil penalties or criminal prosecution.

4. A well driller who fails to notify the Department per Section D.5, or fails to obtain coverage under the general permit, after receiving written notice of violation of a provision of this regulation, is liable for civil penalties.

5. The Department shall have full access to a well driller's bond required by the Department of Labor, Licensing, and Regulation to correct a violation of this regulation and/or Regulation 61-71, Well Standards, where, as part of a Department enforcement action, a well driller is unwilling or unable to take required corrective actions.

J. **SEVERABILITY.** Should any section, paragraph, sentence, clause, phrase, or other part of this regulation be declared invalid for any reason, the remainder shall not be affected thereby.

HISTORY: Added by State Register Volume 23, Issue No. 6, eff June 25, 1999.

61-45. South Carolina Central Cancer Registry.

Table of Contents

- A. Purpose.
- B. Definitions.
- C. Reporting of Cancer Cases.
- D. Cancer Case Identification.
- E. Data Items to be Reported.
- F. Content and Design of Forms and Reports.
- G. Procedures for Disclosure of Confidential Information.
- H. Severability.

A. **PURPOSE.** This regulation establishes rules implementing Sections 44-35-20 through -40, 1976 S.C. Code of Laws and Supplement, regarding the South Carolina Central Cancer Registry (SCCCR) requirements for reporting cancer cases, data elements to be collected, content and design of forms and reports, and the procedures for disclosure of confidential registry information.

B. **DEFINITIONS.**

1. "South Carolina Central Cancer Registry (SCCCR)" means the population-based cancer data system for the collection, storage, maintenance, analysis, and dissemination of all cancer cases occurring in South Carolina, diagnosed after December 31, 1995, under the administration of the South Carolina Department of Health and Environmental Control (DHEC).

2. "Reportable cases" means all malignant tumors, pathologically or clinically diagnosed, including in situ and invasive carcinomas, sarcomas, melanomas, leukemias, and lymphomas, excluding carcinoma in situ of the cervix, and all basal and squamous cell carcinomas of non-genital skin sites. Malignant tumors of the skin of genital sites as described in the current edition of the International Classification of Diseases for Oncology published by the World Health Organization, are reportable. Cases of reportable cancers with the following ambiguous terms in the final diagnosis shall also be reported: probable, suspect, suspicious, compatible with, consistent with, and most likely.

3. "Health care providers" means all South Carolina health care facilities and licensed practitioners that diagnose or treat patients with cancer. These include, but are not limited to, hospitals, independent pathology laboratories, freestanding surgical and treatment centers, physicians, nurse practitioners, and physician assistants.

4. "Resident of South Carolina" means a person who lives and sleeps most of the time in or considers their usual home to be in South Carolina as defined by the United States Census Bureau.

5. "Regional registry" means a population-based data system for the collection, storage, maintenance, analysis and interpretation of cancer data for a designated geographic region of the State.

6. "Pathologically diagnosed cancer cases" means cases determined by a licensed physician to have cancer present with histologic (tissue) confirmation.

7. "Clinically diagnosed cancer cases" means cases determined by a licensed physician to have cancer present without histologic (tissue) confirmation.

8. "North American Association of Central Cancer Registries (NAACCR)" means the body that establishes standards for central cancer registry operations.

9. "Department" or DHEC means the South Carolina Department of Health and Environmental Control.

10. "DHEC Cancer Control Advisory Committee (CCAC)" means the multidisciplinary committee that advises the Board of DHEC and the staff of the Division of Cancer Prevention and Control on professional issues pertaining to cancer prevention, detection, care, and surveillance. This includes all SCCCR activities.

11. "Surveillance Subcommittee" means the subcommittee of the DHEC Cancer Control Advisory Committee that is comprised of statewide representation of cancer researchers, the South Carolina Medical Association, the South Carolina Hospital Association, and the South Carolina Budget and Control Board Office of Research and Statistics. This subcommittee has the specific responsibility to determine the appropriateness of requests for confidential data release from the SCCCR.

C. REPORTING OF CANCER CASES.

1. Reportable cancer cases, as defined, which are initially diagnosed after December 31, 1995 shall be reported to DHEC within six months of initial diagnosis.

2. All health care providers that diagnose and/or treat cancer patients in the State are responsible for reporting cancer cases to DHEC, unless those health care providers are already reporting to a regional cancer registry.

3. Responsibility for Reporting:

a. Hospitals with existing cancer registries shall designate an appropriate person to be responsible for reporting all SCCCR reportable cases to DHEC.

b. Hospitals without a cancer registry shall designate the Director of Health Information Management or the functional equivalent employee to be responsible for reporting all SCCCR reportable cases to DHEC.

c. The Director or the functional equivalent of each independent pathology laboratory and private component of a hospital pathology laboratory shall be responsible for reporting the results of examination of tissue specimens and/or hematology examinations to DHEC. Pathologic and hematologic reports indicating the diagnosis of cancer, that have not been previously reported from that laboratory, shall be reported.

d. Physicians shall report to DHEC all new cancer cases diagnosed in their offices that are not referred to a hospital in the State for treatment.

e. The Director or functional equivalent of each freestanding surgical or treatment center shall be responsible for reporting all new cancer cases to DHEC.

f. Every health care provider shall allow representatives of DHEC upon demand to access, obtain, and copy information from all medical, pathological, and other pertinent records and logs related to cancer cases, as necessary for fulfilling the functions of the SCCCR. Adequate space shall be provided as needed to DHEC staff for record review at South Carolina health care facilities.

g. Regional registries shall abide by the same reporting requirements as for other health care providers in the State.

h. SCCCR staff shall be responsible for continuously monitoring compliance of reporting requirements from all health care providers.

i. SCCCR staff shall be responsible for monitoring timeliness, completeness, and quality of data. Statewide and national quality control audits shall be conducted to assess SCCCR data. The SCCCR shall participate in national quality control audits performed by NAACCR that include review of health care provider records.

j. Every health care provider shall participate in quality control studies developed by the SCCCR in order to access timeliness, completeness, and quality of data according to NAACCR standards.

k. SCCCR staff shall provide appropriate training to health care provider staff on data collection principles and practices as needed.

D. CANCER CASE IDENTIFICATION. All health care providers shall provide case finding documents to permit identification of cancer cases to be reviewed and reported. These case finding documents shall include the following: disease and operation indices for cancer cases; pathology and cytology reports; new patient radiation or chemotherapy logs; and other alternative information deemed necessary to identify or verify reportable cancer cases.

E. DATA ITEMS TO BE REPORTED. All health care providers shall provide to DHEC at least the following data items on all reportable cancer cases in accordance with standard definitions as listed in the current edition of the NAACCR Standards for Cancer Registries, Volume II, Data Standards and Data Dictionary obtained from the NAACCR. The current edition of NAACCR standards can be obtained from the SCCCR office at DHEC:

1. Last name, first name, middle initial
2. Address at initial diagnosis, including city, county, State, and zip code (zip + 4, where available)
3. Race
4. Spanish/Hispanic origin (if applicable)
5. Sex
6. Birth date
7. Social security number
8. Information on the industrial history of the individual with the cancers, to the extent such information is available from the same medical record
9. Information on the occupational history of the individual with the cancers, to the extent such information is available from the same record
10. Date of diagnosis
11. Date of admission
12. Source of information
13. Primary site of the cancer
14. Morphology type, behavior, and grade
15. Sequence number of the cancer
16. Laterality
17. Diagnostic confirmation
18. Stage of disease (pursuant to Summary Staging Guide)
19. Date and type of first course of definitive treatment when available in the medical record
20. Date of death
21. Underlying cause of death

F. CONTENT AND DESIGN OF FORMS AND REPORTS.

1. The information to be reported shall be provided on forms supplied by DHEC. The forms must be completed entirely. Supplemental information can be supplied for forms that cannot be completed entirely by submitting copies of pertinent medical information to include, at a minimum, pathology reports, history and physical, discharge summary, and radiographic reports.

2. Case reports from facilities with existing computerized cancer registries shall be submitted on appropriate electronic medium provided their data items are in accordance with national standards utilized by the SCCCR. The data must be submitted according to the NAACCR standard record layout as specified in the current edition of the Standards for Cancer Registries, Volume II, Data Standards and Data Dictionary.

3. Reportable cases from facilities served by the SCCCR field staff shall be collected in a manner determined by DHEC.

4. The SCCCR staff shall document on standard forms the reportability status and record review status of each health care provider that is contacted.

G. PROCEDURES FOR DISCLOSURE OF CONFIDENTIAL INFORMATION.

1. In accordance with Section 44-35-40, all data obtained from cancer reports submitted to the SCCCR are confidential. All data collected is confidential pursuant to Section 44-1-110. Information identifying individuals with cancer is exempt from Freedom of Information requests pursuant to Section 30-4-40, "Freedom of Information Act", and may not be made available to the public. Identifying information regarding patients, physicians, or reporting facilities is not available by subpoena, and may only be released pursuant to a court order.

2. Data collected on patients whose legal residential address is outside the State of South Carolina may be shared with other State cancer registries provided a reciprocal data sharing agreement is in place with the respective State Health Departments. The SCCCR will insure that such agreements with other States provide data confidentiality provisions.

3. The DHEC CCAC shall advise and make recommendations to the Department about the issues related to cancer surveillance, including all Central Cancer Registry activities. A subcommittee of the CCAC called the Surveillance Subcommittee shall have specific responsibility to determine the appropriateness of requests for confidential data release. Membership of this subcommittee shall consist of statewide representation of cancer researchers, the South Carolina Medical Association, the South Carolina Hospital Association, and the South Carolina Budget and Control Board Office of Research and Statistics. Strict criteria set forth in the SCCCR Data Release Protocol written in coordination with the South Carolina Budget and Control Board Office of Research and Statistics Principles and Protocol for Release of Health Data shall be utilized to review each data release request. This Subcommittee also assures the DHEC Internal Review Board approval when appropriate in order to assure protection of human subjects.

4. Each applicant requesting access to confidential information will follow the procedure outlined in the SCCCR Data Release Protocol, completing the application and providing the required information, documentation, and assurances. The applicant shall provide, at no cost to the SCCCR, a reprint of each publication using Registry information. Any report or published papers must acknowledge DHEC and the SCCCR and data must only be published according to its intended purpose on the application for data release.

5. Requests for non-confidential data as specified in the SCCCR Data Release Protocol will be processed by SCCCR staff, subject to the confidentiality provisions set forth in DHEC regulations.

H. SEVERABILITY. If any provision of these regulations or the application thereof to any facility, individual or circumstance shall be held invalid, such invalidity shall not affect the provisions or application of the regulations which can be given effect, and to this end the provisions of the regulations are declared to be severable.

HISTORY: Added by State Register Volume 22, Part 2, Issue No. 6, eff June 26, 1998.

61-46. Repealed.

HISTORY: Former Regulation, titled Nuisances, repealed by State Register Volume 40, Issue No. 4, Doc. No. 4552, eff April 22, 2016.

61-47. Shellfish.

(Statutory Authority: 1976 Code Section 44-1-140)

TABLE OF CONTENTS.

A. GENERAL PROVISIONS.

1. Purpose and Scope.
2. Definitions.
3. Severability.

B. GROWING AREA SURVEY AND CLASSIFICATION.

1. Sanitary Survey.
2. Classification of Growing Area.
3. Approved Area.
4. Conditionally Approved Area.
5. Restricted Area.
6. Conditionally Restricted Area.
7. Prohibited Area.

C. HARVESTING, HANDLING, AND TRANSPORTATION OF SHELLFISH.

1. Harvesting.

2. Handling.
 3. Transportation.
- D. SPECIAL SHELLSTOCK HANDLING.
1. Relaying.
 2. Interstate Relaying.
 3. Wet Storage.
 4. Depletion of Closed Areas.
 5. Shellfish Habitat Preservation.
- E. SHELLFISH SAMPLING AND STANDARDS.
1. Sampling and Testing.
 2. Adulteration Standards.
- F. LABORATORY PROCEDURES.
1. General.
 2. Microbiological.
 3. Physical and Chemical.
 4. Biotoxin.
- G. CERTIFICATION AND PERMITTING PROCEDURES.
1. General.
 2. Application Requirements.
 3. Issuance of Certificates and Permits.
- H. INSPECTION AND COMPLIANCE.
1. Inspections.
 2. Compliance.
- I. CERTIFIED SHIPPER FACILITIES.
1. General Requirements.
 2. Shellfish Source.
 3. Shellfish Refrigeration.
 4. Shellstock Temperature Management.
 5. Temperature Control.
 6. Shellstock Identification.
 7. Shucked Shellfish Labeling.
 8. Bulk Receiving.
- J. SHUCKER-PACKERS.
1. General Requirements.
 2. Heat Shock.
- K. REPACKERS.
- L. SHELLSTOCK SHIPPERS.
- M. RESHIPPERS.
- N. DEPURATION.
- O. SHELLFISH AQUACULTURE.
1. General.
 2. Seed Source.
 3. Open-Water Operations.
 4. Land-Based Shellfish Operations.
 5. Polyculture Activities.

6. Mariculture Permit Areas.

P. REMEDIES.

1. General.
2. Criminal Liability.

A. GENERAL PROVISIONS.

1. Purpose and Scope. This regulation outlines requirements for producers, harvesters, processors, and transporters of shellfish and is intended to protect the health of consumers of shellfish. The requirements, standards, and implementation methods outlined herein are consistent with the National Shellfish Sanitation Program Guide for the Control of Molluscan Shellfish, published by the United States Department of Health and Human Services, U.S. Food and Drug Administration. The National Shellfish Sanitation Program Guide for the Control of Molluscan Shellfish is partially incorporated by reference within these regulations. This Regulation is intended to protect the health of consumers of shellfish by:

- (a) Establishing sanitary controls for the production, processing, harvesting, handling, distribution, and transportation of shellfish;
- (b) Classifying coastal shellstock growing areas in accordance with accepted public health standards;
- (c) Prohibiting the distribution of adulterated shellfish; and
- (d) Establishing permit and certification requirements for commercial shellfish activities.

2. Definitions. For the purpose of this regulation:

- (a) Adulterated means any one of the following:
 - (1) Shellfish that have been harvested from closed areas;
 - (2) Shellfish that have not been grown, harvested, stored, treated, transported, handled, shucked, packed, tagged, labeled, or offered for sale in compliance with this Regulation;
 - (3) Shellfish deemed unsafe as outlined in E.2;
 - (4) Shellfish that are putrid or unfit for human consumption;
 - (5) Shellfish that have been exposed to any unsanitary conditions;
 - (6) Shellfish that contain any added substance, unless the substance is authorized by the Department or the United States Food and Drug Administration;
 - (7) determined to contain any poisonous or deleterious substance at a level or concentration likely injurious to public health.
- (b) Adverse Pollution Condition means a state or situation caused by meteorological, hydrological or seasonal events or point source discharges that has historically resulted in elevated fecal coliform levels in a particular harvest area.
- (c) Approved means a shellfish water quality classification that allows shellfish harvest for direct marketing for human consumption.
- (d) Approved Area means a growing area where the water quality has been classified by the Department for harvesting shellfish for direct marketing for human consumption.
- (e) Aquaculture means the cultivation of shellfish in land-based artificial growing or harvest areas, or confined cultivation in South Carolina Department of Natural Resources-permitted natural growing or harvest areas.
- (f) Bulk means any of the following:
 - (1) A single lot of shellstock stored or shipped in individual packages which are contained within a sealed master carton or on a wrapped pallet;
 - (2) A single lot of unpackaged shellstock shipped in a single large-volume container such as a vehicle or vessel;
 - (3) A single lot of shellstock held in multiple large capacity tubs, totes, net brailers, or other holding units when being transported from a growing area to a certified shipper.

(g) Certified Shipper means a person engaged in the business of selling, distributing or otherwise transporting shellfish and who has a valid certification as a Depuration Processor(DP), Shucker-Packer(SP), Repacker(RP), Shellstock Shipper(SS), or Reshipper(RS) issued by the state in which his facility is located.

(h) Certification Number means the unique identification number assigned by the Department to each certified shipper.

(i) Classification or Classify means the designation of a growing area harvest category or categories. A growing area may be classified as any combination of approved, conditionally approved, restricted, conditionally restricted, or prohibited.

(j) Classified Growing Area means a growing area for which the Department has completed a sanitary survey report and assigned classifications of approved, conditionally approved, restricted, conditionally restricted, or prohibited.

(k) Closed Area means a growing area where the harvesting of shellfish is temporarily or permanently not allowed. The Department may place any growing area in a closed area status.

(l) Coliform Group means all of the aerobic and facultative anaerobic, gram negative, nonspore forming, rod shaped bacilli that ferment lactose broth with gas formation within forty-eight (48) hours at ninety-five (95) degrees Fahrenheit (35 degrees (0.5 degrees Centigrade).

(m) Commingle or Commingling means the act of combining different lots of shellstock or shucked shellfish.

(n) Conditionally Approved means a shellfish water quality classification used to identify a growing area that meets approved criteria except under conditions described in a management plan.

(o) Conditionally Approved Area means a growing area that meets approved area criteria under certain environmental conditions determined by the Department. Direct harvesting of shellfish for human consumption is allowed at times and under conditions determined by the Department through collection of water quality and pollution source data. Conditionally approved area management employs criteria specified in a management plan.

(p) Conditionally Restricted means a shellfish water quality classification used to identify a growing area that meets restricted criteria except under conditions described in a management plan.

(q) Conditionally Restricted Area means a growing area that meets Restricted Area criteria under specific conditions determined by the Department. Conditionally restricted area management employs criteria specified in a management plan.

(r) Container means any bag, box, crate, tub, carton, or other conveyance in which shellfish may be held, carried or transported.

(s) Critical Control Point (CCP) means a point, step or procedure in a food process at which control can be applied, and a food safety hazard can, as a result of the control, be prevented, eliminated or reduced to acceptable levels.

(t) Critical deficiency means a condition or practice that results in the production of a product that is unwholesome or presents a threat to the health or safety of the consumer.

(u) Critical limit means the maximum or minimum value to which a physical, biological or chemical parameter must be controlled at a critical control point to prevent, eliminate or reduce to an acceptable level the occurrence of the identified food safety hazard.

(v) Department means the South Carolina Department of Health and Environmental Control or agents thereof having responsibility for enforcing these regulations.

(w) Depletion means the removal and disposal of all market-size shellfish from a growing area in a manner to prevent human consumption.

(x) Depuration means the process of using a controlled aquatic environment to reduce the level of bacteria and viruses in live shellfish.

(y) Depuration Facility means the physical structure wherein depuration is accomplished, including all the appurtenances necessary to the effective operation thereof.

(z) Depuration Processor (DP) means a person who is certified to receive shellstock from approved or restricted growing areas and submit such shellstock to a depuration process.

(aa) Dry Storage means the storage of shellstock out of the water.

(bb) Employee means an individual who handles, stores, transports, sells, or distributes shellfish and is employed by someone with a shellfish certificate or permit.

(cc) Fecal Coliform means that portion of the coliform group that will produce gas from lactose in an EC or A-1 multiple tube procedure liquid medium within twenty-four (24) (+ 2) hours in a water bath maintained at one hundred twelve (112) degrees Fahrenheit [forty-four and one-half (44.5) (0.2 degrees Centigrade)].

(dd) Growing Area means an estuary or coastal river area delineated by the Department that supports or could support live shellfish. For purposes of this regulation, growing waters shall be synonymous with growing area.

(ee) HACCP is an acronym that stands for Hazard Analysis Critical Control Point, a systematic, science based approach used in food production as a means to assure food safety.

(ff) HACCP Plan means a written document that delineates the formal procedures that a processor follows to implement the HACCP requirements set forth in 21 CFR § 123.6 (April 1, 2007) as adopted by the Interstate Shellfish Sanitation Conference.

(gg) Harvest means the act of removing shellstock from growing areas and its placement on or in manmade conveyance or other means of transport.

(hh) Harvester means a person who gathers shellfish by any means from a growing area.

(ii) Lot means any of the following:

(1) A single type of bulk shellstock or containers of shellstock of no more than one day's harvest from a single defined growing area;

(2) A collection of containers of no more than one day's shucked shellfish product produced under conditions as nearly uniform as possible, and designated by a common container code;

(3) Shellstock harvested for depuration from a particular area during a single day's harvest and delivered to one depuration facility.

(jj) Mariculture means controlled cultivation in confinement of marine and estuarine organisms in salt waters.

(kk) Marina means any of the following:

(1) locked harbor facility;

(2) any facility which provides fueling, pump-out, maintenance or repair services (regardless of length);

(3) any facility which has effective docking space of greater than 250 linear feet or provides moorage for more than 10 boats;

(4) any water area with a structure which is used for docking or otherwise mooring vessels and constructed to provide temporary or permanent docking space for more than ten boats, such as a mooring field; or

(5) a dry stack facility.

(ll) National Shellfish Sanitation Program means the program cooperatively developed by state, United States Food and Drug Administration, and shellfish industry representatives resulting in sanitary control guidelines that ensure that the shellfish produced in accordance with guidelines will be safe and sanitary.

(mm) National Shellfish Sanitation Program Guide for the Control of Molluscan Shellfish means the 2015 version of the United States Food and Drug Administration document with that title that consists of a Model Ordinance, supporting guidance documents, recommended forms, and other related materials associated with the National Shellfish Sanitation Program. Portions of the document are incorporated by reference herein and such referenced sections shall have effect as if fully recited within the text of this regulation. Copies can be obtained through the U.S. Food and Drug Administration or the S.C. Department of Health and Environmental Control, 2600 Bull Street, Columbia, SC 29201.

(nn) Person means any individual, partnership, company, corporation, trustee, association, agency, or any public or private entity.

(oo) Poisonous or Deleterious Substance means a toxic compound occurring naturally or added to the environment that may be found in shellfish or shellfish growing waters for which a regulatory tolerance limit or action level has been established or may be considered harmful to public health. Examples of naturally occurring substances would include paralytic shellfish toxins and trace elements geologically leached from the environment, such as mercury; examples of added substances would include agricultural pesticides and polynuclear aromatics.

(pp) Post Harvest Processing means processing of shellfish for the purpose of added safety or quality that involve hazards not addressed by controls in the National Shellfish Sanitation Program Guide for the Control of Molluscan Shellfish Model Ordinance for shucker-packers, repackers, shellstock shippers, or reshippers.

(qq) Process means those actions related to the operation of the Certified Shipper facilities of Depuration Processors(DP), Shucker-Packers(SP), Repackers(RP), Shellstock Shippers(SS), and Reshippers(RS).

(rr) Processor means a certified shipper.

(ss) Prohibited means an administrative classification that disallows shellfish harvest for human consumption.

(tt) Prohibited Area means a growing area that has been closed by the Department for the harvesting of shellfish for any purpose related to direct human consumption.

(uu) Raw means shellfish that have not been thermally processed:

(1) to an internal temperature of one hundred and forty-five (145) degrees Fahrenheit or greater for fifteen (15) seconds (or equivalent); or

(2) to alter the organoleptic characteristics.

(vv) Relaying means the transfer of shellstock from restricted areas or conditionally restricted areas to approved or conditionally approved areas for natural biological cleansing using the ambient environment as a treatment system.

(ww) Repacker (RP) means a certified shipper who packs shucked shellfish into containers other than those in which they were originally packaged. A repacker may act as a shellstock shipper.

(xx) Repacking means the transfer of shucked shellfish into containers other than those in which they were originally packaged.

(yy) Reshipper (RS) means certified shippers who purchase shellfish from other certified shippers and sell or distribute the shellfish without repackaging.

(zz) Restricted means a shellfish water quality classification that does not meet approved water quality criteria, disallows direct marketing of shellfish, and allows shellfish harvest only by special permit.

(aaa) Restricted Area means a growing area that has been classified by the Department as not meeting water quality criteria that would allow harvesting shellfish for direct marketing for human consumption. In a restricted area, shellfish may be harvested only by special permit and direct marketing of harvested shellfish is not allowed.

(bbb) Sanitary Survey Report means a written evaluation of all actual and potential pollution sources and environmental factors that affect shellfish growing area water quality.

(ccc) Sanitize means adequate treatment of food contact surfaces by a process that is effective in destroying vegetative cells of microorganisms of public health significance and in substantially reducing the number of other microorganisms. Such treatment shall be safe and not adversely affect shellfish.

(ddd) Scheduled Depuration Process means the process that places shellfish harvested from conditionally restricted, restricted, or approved waters into a controlled aquatic environment selected by the processor and that has been demonstrated to the Department to effectively reduce the level of fecal coliform bacteria in live shellfish.

(eee) Seed means juvenile shellstock intended for growth to market size.

(fff) Shellfish means all edible species of oysters, clams, mussels, and scallops; either shucked or in the shell; fresh or fresh frozen; whole or in part, except that scallops shall be excluded when the final product is the adductor muscle only.

(ggg) Shellstock means live molluscan shellfish in the shell.

(hhh) Shellstock Shipper (SS) means a certified shipper who grows, harvests, buys, or sells shellstock. A shellstock shipper is not certified to shuck shellfish or repack shucked shellfish. A shellstock shipper may repackage shellstock or act as a reshipper.

(iii) Shucked Shellfish means shellfish that have been removed from their shells.

(jjj) Shucker-Packer (SP) means a certified shipper who shucks and packs shellfish. A shucker-packer may act as a repacker, shellstock shipper, or reshipper.

(kkk) State Shellfish Control Authority or Authority means the South Carolina Department of Health and Environmental Control or, in reference to another state, the state agency having the primary authority to implement public health-related shellfish regulations.

(lll) Systematic Random Sampling is a field sampling and data analysis design that employs a preestablished sampling schedule and assumes that a statistically representative cross section of all meteorological, hydrographic, and/or other pollution events will be included in the data set.

(mmm) Triploid oyster means an oyster having three sets of homologous chromosomes.

(nnn) Vehicle means any truck, car, bus, trailer, railcar, aircraft, boat, ship, barge, dredge, or other means of conveyance by which shellfish is transported from one location to another.

(ooo) Vessel means any boat, ship, barge, dredge, or other type of watercraft used for the commercial harvest or transport of shellfish for human consumption.

(ppp) Wet Storage means storage of marketable shellfish in water after initial harvest.

3. Severability. In the event that any portion of these regulations is construed by a court of competent jurisdiction to be invalid, or otherwise unenforceable, such determination shall in no manner affect the remaining portions of these regulations, and they shall remain in effect, as if such invalid portions were not originally a part of these regulations.

B. GROWING AREA SURVEY AND CLASSIFICATION.

1. Sanitary Survey. A sanitary survey of shellfish growing areas shall be conducted by the Department, and each area shall be classified prior to its approval for shellfish harvesting. Sanitary Surveys and reports will be conducted and prepared consistent with the National Shellfish Sanitation Program Guide for the Control of Molluscan Shellfish.

2. Classification of Growing Area. Shellfish growing areas shall be identified and assigned harvesting classifications of approved, conditionally approved, restricted, conditionally restricted, or prohibited. The assigned classification will be based upon a sanitary survey conducted by the Department. Growing areas for which a sanitary survey has not been completed shall be classified as prohibited. The Department may also designate a growing area as a closed area and prohibit harvesting when it determines that conditions have occurred that may potentially render shellfish unsafe for human consumption.

3. Approved Area. Growing areas shall be classified approved when the sanitary survey concludes that fecal material, pathogenic microorganisms, and poisonous or deleterious substances are not present in concentrations that would render shellfish unsafe for human consumption. Approved classifications shall be determined upon a sanitary survey that includes water samples collected from stations in the designated area adjacent to actual or potential sources of pollution. For waters sampled under adverse pollution conditions, the median fecal coliform Most Probable Number (MPN) or the geometric mean MPN shall not exceed fourteen per one hundred milliliters, nor shall more than ten percent of the samples exceed a fecal coliform MPN of forty-three per one hundred milliliters (per five tube decimal dilution). For waters sampled under a systematic random sampling plan, the geometric mean fecal coliform MPN shall not exceed fourteen per one hundred milliliters, nor shall the estimated ninetieth percentile exceed an MPN of forty three per one hundred milliliters (per five tube decimal dilution). Computation of the estimated ninetieth percentile shall be determined using National Shellfish Sanitation Program Guide for the Control of Molluscan Shellfish methodology.

4. Conditionally Approved Area.

(a) Growing areas may be classified conditionally approved when they are subject to temporary conditions of actual or potential pollution. When such events are predictable, as in non-point source pollution from rainfall runoff or discharge of a major river, a management plan describing conditions under which harvesting will be allowed shall be adopted by the Department prior to classifying an area as conditionally approved. Where appropriate, the management plan for each conditionally approved area shall include performance standards for sources of controllable pollution (e.g., wastewater treatment and collection systems), evaluation of each source of pollution, and means of rapidly closing and subsequently reopening areas to shellfish harvesting. Memorandums of agreements shall be a part of these management plans where appropriate.

(b) Shellfish shall not be directly marketed from a conditionally approved area until conditions for an approved classification have been met for a period of time likely to ensure the shellfish are safe for consumption.

(c) Shellstock from conditionally approved areas that have been subjected to temporary conditions of actual or potential pollution may be relayed to approved areas for purification or depuration through controlled purification operations only by special permit issued by the Department.

5. Restricted Area.

(a) Growing areas shall be classified restricted when sanitary survey data show a moderate degree of pollution or the presence of deleterious or poisonous substances to a degree that may cause the water quality to fluctuate unpredictably or at such a frequency that a conditionally approved classification is not feasible. Shellfish may be harvested from areas classified as restricted only for the purposes of relaying or depuration and only by special permit issued by the Department and under Department supervision.

(b) The suitability of restricted areas for harvesting of shellstock for relay or depuration purposes may be determined through the use of comparison studies of background tissue samples with post-process tissue samples, as well as other process verification techniques deemed appropriate by the Department.

(c) For restricted areas to be utilized as a source of shellstock for depuration, or as source water for depuration, the fecal coliform geometric mean MPN of restricted waters sampled under adverse pollution conditions shall not exceed eighty-eight per one hundred milliliters nor shall more than ten percent of the samples exceed a MPN of two hundred and sixty per one hundred milliliters for a five tube decimal dilution test. For waters sampled under a systematic random sampling plan, the fecal coliform geometric mean MPN shall not exceed eighty-eight per one hundred milliliters nor shall the estimated ninetieth percentile exceed an MPN of two hundred and sixty (five tube decimal dilution). Computation of the estimated ninetieth percentile shall be obtained using National Shellfish Sanitation Program Guide for the Control of Molluscan Shellfish methodology.

6. Conditionally Restricted Area.

(a) Growing areas may be classified conditionally restricted when they are subject to temporary conditions of actual or potential pollution. When such events are predictable, as in the malfunction of wastewater treatment facilities, non-point source pollution from rainfall runoff, discharge of a major river or potential discharges from dock or harbor facilities that may affect water quality, a management plan describing conditions under which harvesting will be allowed shall be prepared by the Department prior to classifying an area as conditionally restricted. Where appropriate, the management plan for each conditionally restricted area shall include performance standards for sources of controllable pollution, e.g., wastewater treatment and collection systems and an evaluation of each source of pollution, and description of the means of rapidly closing and subsequent reopening areas to shellfish harvesting. Memorandums of agreements shall be a part of these management plans where appropriate.

(b) Shellfish may be harvested from areas classified as conditionally restricted only for the purposes of relaying or depuration and only by permit issued by the Department and under Department supervision.

(c) For conditionally restricted areas to be utilized as a source of shellstock for depuration, the fecal coliform geometric mean MPN of conditionally restricted waters sampled under adverse pollution conditions shall not exceed eighty-eight per one hundred milliliters nor shall more than ten percent of the samples exceed a MPN of two hundred and sixty per one hundred milliliters for a

five tube decimal dilution test. For waters sampled under a systematic random sampling plan, the fecal coliform geometric mean MPN shall not exceed eighty-eight per one hundred milliliters nor shall the estimated ninetyeth percentile exceed an MPN of two hundred and sixty per one hundred milliliters (five tube decimal dilution). Computation of the estimated ninetyeth percentile shall be obtained using National Shellfish Sanitation Program Guide for the Control of Molluscan Shellfish methodology.

7. Prohibited Area.

(a) Growing areas shall be classified prohibited if there is no current sanitary survey report or if the sanitary survey report or monitoring data show unsafe levels of fecal material, pathogenic microorganisms, or poisonous or deleterious substances in the growing area or otherwise indicate that such substances could potentially reach quantities that could render shellfish unfit or unsafe for human consumption.

(b) Harvesting of shellfish from prohibited areas for human consumption shall not be allowed by the Department. This item shall not be construed to prohibit seed hatchery or nursery operations, provided such operations comply with applicable provisions of this regulation.

(c) Shellfish may be depleted for non-food use from prohibited areas upon approval of the Department and under specified conditions as outlined in D.4.

(d) Growing areas receiving sewage treatment plant and other waste discharges shall be classified as prohibited. The following assumptions and criteria will be considered in determining the area that could be potentially impacted:

- (1) Pollution Conditions;
 - (a) Flow rate;
 - (b) Sewage treatment plant performance;
 - (c) Location of shellfish resources.
- (2) Dispersion, dilution, and time of travel;
 - (a) Current velocity and net transport velocity;
 - (b) Volume;
 - (c) Depth of water;
 - (d) Direction of travel and stratification;
 - (e) Location of discharge;
 - (f) Tidal characteristics;
 - (g) Receiving area geometry.
- (3) Decay rate (bacteriological die-off);
- (4) Bacteriological quality required;
- (5) Adjacent harvest use classification;
- (6) Identifiable landmarks for boundaries.

(e) Growing waters within and adjacent to marinas shall be classified as prohibited. The size and extent of closures within and adjacent to marinas shall be determined using a dilution analysis that incorporates the following assumptions:

- (1) An occupancy rate of the marina;
- (2) An assumed rate of boats that will discharge untreated waste;
- (3) An occupancy rate of two (2) persons per boat;
- (4) A rate of discharge of 2×10 to the ninth power fecal coliform per day;
- (5) Wastes are completely mixed in and around the marina;
- (6) The volume of water in the vicinity of the marina;
- (7) A theoretical calculated fecal coliform level of fourteen (14) MPN per one hundred (100) milliliters.

(f) Nothing in this regulation shall be construed to require that a dilution analysis be conducted for any existing marina historically encompassed by a prohibited closure of one thousand (1000) feet; provided however, that in the event a request or application is made seeking authorization to increase the marina's potential boat occupancy rate, the Department shall calculate the prohibited closure area in accordance with B.7.(e).

(g) Any proposed or existing dry stack or fueling facility having effective docking space of two hundred and fifty (250) linear feet or less and providing moorage for ten (10) or less boats shall not constitute sole cause for classification or closure in accordance with item B.7.(e) of this Regulation.

C. HARVESTING, HANDLING, AND TRANSPORTATION OF SHELLFISH.

1. Harvesting.

(a) Harvesting of Shellfish from Closed Waters. It shall be unlawful to harvest, remove, take, buy, sell, offer for sale, or possess shellfish from areas closed by the Department. This Section shall not be construed to prevent harvesting as permitted by the Department.

(b) Harvesting Vessels. It shall be unlawful for any person engaged in commercial shellfish activities to harvest, handle, or transport shellstock in a vessel that has not been constructed, operated, and maintained to prevent contamination, deterioration, and decomposition of the shellstock.

(1) Decks and storage bins shall be constructed and located to prevent bilge water, fuel, oil, or polluted overboard water from coming into contact with the shellstock;

(2) Bilge pump discharges shall be located so that the discharge shall not contaminate shellstock;

(3) Containers used for storing shellstock shall be clean and fabricated from safe materials;

(4) Decks and storage bins used in the harvest or transport of shellstock for direct marketing shall be provided with effective drainage and kept clean with potable water or with water from a growing area in the open status;

(5) All vessels and equipment coming in contact with shellstock during handling or transport for relaying or depuration shall be thoroughly cleaned before the boat and equipment are used to transport or handle shellfish for direct marketing;

(6) Coverings shall be provided on unattended vessels to protect shellstock from exposure to hot sun, birds, and other adverse conditions.

(c) Identification of Shellstock During Harvest.

(1) Commercial harvesters shall affix a harvest identification tag to containers of shellstock prior to removal of the shellstock from the area in which it was harvested. Harvest identification tags shall:

(a) Be prominently labeled "Harvest Tag";

(b) Be durable and waterproof;

(c) Be at least 13.8 square inches in size;

(d) Contain the following accurate, indelible and legible information:

(1) Harvester's commercial saltwater fishing license number, as issued by the South Carolina Department of Natural Resources;

(2) Date and harvest start time;

(3) Harvest area;

(4) Name and certificate number of the certified shipper to whom the shellfish are being delivered;

(5) Type and quantity of shellstock.

(e) Not be altered in any manner.

(2) When shellstock are harvested from more than one harvest area on any single harvest day, each container of shellstock shall be tagged with an individual harvest identification tag.

(3) When shellstock are harvested from a single harvest area on a single day, multiple containers of shellstock may be held on a wrapped pallet, in a tub or tote, in a net brailer, or in

other types of holding units, provided each individual wrapped pallet, tub or tote, net brailer, or other holding unit shall be tagged with a harvest identification tag meeting all requirements included in item C.1.(c)(1).

(4) When shellstock are harvested from a single harvest area on a single day, and a harvest vessel utilizes open decks or holds, tubs or totes, or other similar large-capacity holding units for the transport of loose, bulk shellstock, the vessel may utilize a single harvest identification tag. This tag shall be affixed to the vessel.

(5) In addition to the requirements of item C.1.(c)(1), a harvest identification tag used for tagging a holding unit shall include the following statement; "All shellstock containers in this lot have the same harvest date and area of harvest".

(6) In addition to the requirements of item C.1.(c)(1) and item C.1.(c)(5), a harvest identification tag used to identify a holding unit shall include documentation of the number of individual containers in the unit.

(d) Disposal of Body Waste.

(1) No person shall discharge untreated human fecal waste into any shellfish growing area.

(2) An approved marine sanitation device (MSD) or portable toilet shall be required on any commercial shellfish harvest vessel utilizing mechanical harvesting equipment. Use of other receptacles for sewage disposal may be allowed by the Department if the receptacles are:

(a) Constructed of impervious, cleanable materials and have tight fitting lids; and

(b) Used only for the purpose intended;

(c) Secured while on board and located, operated, and maintained to prevent contamination of shellstock by spillage or leakage.

(e) Prior to licensing each certified shipper shall obtain Department approved training annually.

(f) Harvesters shall complete Department approved training annually. The certified shippers shall only receive shellstock from harvesters who have completed Department approved training annually.

2. Handling.

(a) Shellstock shall be protected from contamination at all times.

(b) Shellstock Temperature Control.

(1) Shellstock Temperature Control is the management of the internal temperature of shellstock by means of ice, mechanical refrigeration or other approved means which is capable of lowering the temperature of the shellstock and will maintain shellstock at fifty (50) degrees Fahrenheit (ten (10) degrees Centigrade) or less. Ice must be from a Department approved source.

(2) Within two (2) hours of receiving shellstock from a harvester, certified shippers shall implement procedures to control shellstock temperature as described in item C.2.(b)(1). For purposes of this item, shellstock shall be considered received when the shellstock are located in any portion of a certified shipper facility. Nothing in this item shall be construed to increase the maximum allowable time period for shellstock temperature control.

(c) Shellstock harvested during months that do not require additional temperature controls shall be placed under temperature control by the receiving certified shipper within eighteen (18) hours from the time of harvest.

(d) Months that do require additional temperature controls will be designated in the latest version of the South Carolina Vibrio Control Plan, which is updated annually in accordance with the National Shellfish Sanitation Program Guide for the Control of Molluscan Shellfish.

(e) Shellstock harvested during months that do require additional temperature controls shall be limited to clams as described in item C.2.(e)(1) and maricultured triploid oysters and shall be managed as follows:

(1) Clams shall be under temperature control by the receiving certified shipper within twelve (12) hours from the time of harvest or may be tempered for a longer period of time using a Department approved tempering plan. For the purpose of this item, clams means the species *Mercenaria mercenaria*, unless otherwise approved by the Department.

(2) Harvesters shall only harvest maricultured triploid oysters submerged for a minimum of 14 days prior to harvest. The certified shipper shall place the triploid oysters under temperature controls sufficient to reach an internal temperature of fifty (50) degrees Fahrenheit (ten (10) degrees Centigrade) or less within two (2) hours from the time the triploid oysters are received by the certified shipper. For purposes of this item, triploid oysters shall be considered received by the certified shipper when the triploid oysters are located in any portion of a certified shipper facility. The time from harvest to receipt by a certified shipper shall be managed as follows:

(a) The certified shipper shall only receive triploid oysters harvested on the same calendar day. The certified shipper shall not receive triploid oysters after 10:00 A.M. unless the triploid oysters are iced or mechanically refrigerated as described in item C.2.(e)(2)(c).

(b) For triploid oysters received by the certified shipper after 10:00 AM, the certified shipper shall only receive triploid oysters that are:

(i) within 4 hours from the start of harvest; and

(ii) completely covered by ice or mechanically refrigerated at an ambient air temperature of forty-five (45) degrees Fahrenheit (seven (7) degrees Centigrade) or less.

(c) The harvester shall only deliver triploid oysters harvested on the same calendar day to a certified shipper. For triploid oysters received by the certified shipper after 10:00 AM, the harvester shall place triploid oysters into cooling immediately after harvesting by completely covering the triploid oysters with ice or by mechanical refrigeration maintained at an ambient air temperature of forty-five (45) degrees Fahrenheit (seven (7) degrees Centigrade) or less. After being placed into cooling, the harvester shall keep the triploid oysters in cooling continuously until received by the certified shipper. The harvester shall follow the procedures for cooling and maintaining continuous cooling for the triploid oysters that are included in the operational plan required in item O.6. The harvester shall use ice from a Department approved source.

(d) It shall be unlawful for a certified shipper to receive at their facility oysters harvested from South Carolina waters during the months that require additional controls that have not been maricultured and harvested and handled in compliance with the requirements of item C.2.(e)(2)(a)(b) and (c). Certified shippers that choose to receive and distribute oysters harvested from South Carolina waters during the months that require additional controls must incorporate into their HACCP plan additional receiving controls to ensure the triploid oysters being received and distributed have been maricultured and harvested and handled in compliance with the requirements of item C.2.(e)(2)(a)(b) and (c).

(f) Temperature control requirements for confirmed illnesses.

(1) In the event a growing area or portion of a growing area is confirmed as the original source of product associated with two (2) or more *Vibrio vulnificus* illnesses within the past (10) years, the maximum hours to temperature control for shellfish shall, upon notice provided by the Department, be in accordance with the National Shellfish Sanitation Program Guide for the Control of Molluscan Shellfish Model Ordinance, VIII. Control of Shellfish Harvesting. Shellfish not meeting times and temperature controls may, with Department approval, be diverted to post-harvest processing as defined in this regulation or be deemed adulterated.

(2) In the event a growing area or portion of a growing area is confirmed as the original source of product associated with two (2) or more *Vibrio parahaemolyticus* illnesses within the past five (5) years, the maximum hours to temperature control for shellfish shall, upon notice provided by the Department, be in accordance with the National Shellfish Sanitation Program Guide for the Control of Molluscan Shellfish Model Ordinance, VIII. Control of Shellfish Harvesting. Shellfish not meeting times and temperature controls may, with Department approval, be diverted to post-harvest processing as defined in this regulation or be deemed adulterated.

(g) Identification of Shellstock in the Marketplace.

(1) When at the facilities of a certified shipper, unless certified as a reshipper (RS), shellstock shall be tagged in accordance with the provisions of item C.1.(c) or item C.2.(g)(2) at all times.

(2) Shellstock distributed or offered for sale within the State shall be identified with tags that are:

- (a) Labeled as "Sale Tag";
- (b) Durable and waterproof;
- (c) At least 13.8 square inches (89.03cm²) in size;
- (d) Legible and indelible, and contains accurate, unaltered information in the order specified below:
 - (1) The dealer's name and address;
 - (2) The dealer's certification number as assigned by the Authority;
 - (3) The original shellstock shipper's certification number. If depurated, the original shellstock shipper's certification number is not required;
 - (4) The date and, when shellstock have been harvested in South Carolina, the time of harvest shall be included. All depurated shellstock shall include the date and time of depuration processing;
 - (5) If depurated, the depuration cycle number or lot number;
 - (6) The most precise identification of the harvest location as is practicable including the initials of the state of harvest, and the Authority's designation of the growing area by indexing, administrative or geographic designation. If the Authority has not indexed growing areas, then an appropriate geographical or administrative designation must be used (e.g. Long Bay, Decadent County, lease number, bed, or lot number);
 - (7) When the shellstock has been transported across state lines and placed in wet storage in a dealer's operation, the statement: "THIS PRODUCT IS A PRODUCT OF (NAME OF STATE) AND WAS WET STORED AT (FACILITY CERTIFICATION NUMBER) FROM (DATE) TO (DATE)";
 - (8) The type and quantity of shellstock;
 - (9) The following statement in bold capitalized type on each tag: "THIS TAG IS REQUIRED TO BE ATTACHED UNTIL CONTAINER IS EMPTY OR IS RETAGGED AND THEREAFTER KEPT ON FILE FOR 90 DAYS.";
 - (10) All shellstock intended for raw consumption shall include a consumer advisory. The following statement, based upon guidance provided in Section 3-603.11 of the United States Food and Drug Administration 2013 Food Code (Copies can be obtained through the U.S. Food and Drug Administration or the S.C. Department of Health and Environmental Control, 2600 Bull Street, Columbia, SC 29201.), or an equivalent statement, shall be included on all shellstock: "RETAILERS, INFORM YOUR CUSTOMERS: Consuming raw or undercooked meats, poultry, seafood, shellfish or eggs may increase your risk of foodborne illness, especially if you have certain medical conditions.";
 - (11) The statement "Keep Refrigerated" or an equivalent statement.
- (h) Shucked Shellfish Temperature Control. Shucked shellfish shall be stored and maintained in accordance with the following:
 - (1) Within two (2) hours of shucking, shucked shellfish shall be stored and maintained at temperatures of forty-five (45) degrees Fahrenheit or below;
 - (2) Frozen shucked shellfish shall be stored and maintained at temperatures of zero (0) degrees Fahrenheit or below.
- (i) Shucked Shellfish Labeling. Prior to sale or distribution, each individual container of shucked shellfish shall be labeled as follows:
 - (1) The shucker-packer's or repacker's certification number shall be displayed on the label of each package of shucked shellfish;
 - (2) Packages containing less than sixty-four (64) fluid ounces shall include:
 - (a) The words "SELL BY" or "BEST IF USED BY" followed by a reasonable date when the product would be expected to reach the end of its shelf life;
 - (b) The date as a month and day of the month; and
 - (c) For fresh frozen shellfish, the year shall be added to the date.

(3) Packages containing sixty-four (64) fluid ounces or more shall be labeled in the following manner:

(a) The words "DATE SHUCKED" followed by the date shucked located on both the lid and sidewall or bottom of the container;

(b) The date shall consist of either the abbreviation for the month and number of the day of the month or in Julian format (YDDD), the last digit of the four digit year and the three digit number corresponding the day of the year; and

(c) For fresh frozen shellfish, the year shall be added to the date (for non-Julian format).

(4) Frozen shucked shellfish shall be labeled as frozen in type-size of equal prominence to the type of shellfish;

(5) Repacked shellfish shall:

(a) Include the original date of shucking on packages of sixty-four (64) fluid ounces or more;

(b) Use the original date of shucking to establish the "Sell By Date" on packages containing less than sixty-four (64) fluid ounces;

(c) If thawed for repacking, be labeled as previously frozen.

3. Transportation.

(a) Shellfish in transportation shall be protected from contamination at all times.

(b) Vehicles used to transport shellfish shall be constructed, operated, and maintained to prevent contamination, deterioration, and decomposition of shellfish. Shellfish transported in unenclosed vehicles shall at all times be protected by effective coverings, provided, however, that this requirement shall not apply to an occupied vessel during shellstock harvest and delivery by water route to a certified shipper.

(c) Commercial shellstock shipments, intended or offered for human consumption shall:

(1) Include a Bill of Sale; and

(2) Be properly identified or labeled in accordance with this regulation; and

(3) Be transported in accordance with the following protocols:

(a) When shipping time is no more than four (4) hours:

(1) Shellstock shall be alive and transported under mechanical refrigeration, equipped with automatic controls, at ambient air temperatures of forty-five (45) degrees Fahrenheit or less; or

(2) Shellstock shall be alive and transported using ice; and

(3) Shellstock shall be cooled to an internal shellstock body temperature of fifty (50) degrees Fahrenheit or less.

(b) When shipping time is greater than four (4) hours:

(1) Shellstock shall be alive and transported under mechanical refrigeration, equipped with automatic controls, at ambient air temperatures of forty-five (45) degrees Fahrenheit or less; or

(2) Shellstock shall be shipped in containers having an internal ambient air temperature of forty-five (45) degrees Fahrenheit or less; and

(3) Shellstock shall be shipped alive and cooled to an internal shellstock body temperature of fifty (50) degrees Fahrenheit or less.

(4) Nothing in item C.3.(c)(3) shall be construed to make unlawful the intrastate shipment of shellstock harvested from within the State provided such shellstock have not exceeded any maximum allowable time period for temperature control as established by item C.2.(c) and C.2.(e).

(5) Shipments must include a time-temperature recording device when shipping from one certified shipper to another certified shipper.

(d) Commercial shipments of non-frozen shucked or post harvest processed shellfish shall:

(1) Include a Bill of Sale; and

- (2) Be properly identified in accordance with this regulation; and
- (3) Be transported in accordance with the following temperature protocols:
 - (a) When shipping time is no more than four (4) hours:
 - (1) Non-frozen shucked or post-harvest processed shellfish shall be transported under mechanical refrigeration, equipped with automatic controls, at ambient air temperatures or forty-five (45) degrees Fahrenheit or less; or
 - (2) Transported well iced; and
 - (3) Be cooled to an internal temperature of forty-five (45) degrees Fahrenheit or less.
 - (b) When shipping time is greater than four (4) hours:
 - (1) Non-frozen shucked or post-harvest processed shellfish shall be transported under mechanical refrigeration, equipped with automatic controls, at ambient air temperatures of forty-five (45) degrees Fahrenheit or less; or
 - (2) Non-frozen shucked or post-harvest processed shellfish shall be shipped in containers having an internal ambient air temperature of forty-five (45) degrees Fahrenheit or less; and
 - (3) Non-frozen shucked or post-harvest processed shellfish shall be cooled to an internal shellstock body temperature of forty-five (45) degrees Fahrenheit or less.
 - (4) An operative time-temperature indicating device shall accompany each shipment.
 - (e) Ice used to cool shellfish during transport shall:
 - (1) Be produced from potable water in a commercial ice machine inspected by the Department; or
 - (2) Be produced at a facility sanctioned by an appropriate regulatory agency.
 - (f) Cats, dogs, and other animals shall not be allowed in any part of the truck or other vehicle where shellstock is stored.
 - (g) Containers used to transport shellstock shall not be constructed, used, or maintained in any manner that would result in product contamination.

D. SPECIAL SHELLSTOCK HANDLING.

1. Relaying.

(a) Shellstock may be harvested and relayed from restricted or conditionally restricted areas to approved or conditionally approved areas for natural biological purification. The shellstock for relaying shall be of such quality that purification will be effective in reducing contaminants to safe levels.

(b) Following approval by the South Carolina Department of Natural Resources, relaying operations may be permitted and supervised by the Department. Only shellfish harvested from waters meeting approved area criteria as defined in B.3 shall be certified for marketing.

(c) Applications for Relay Permits must designate whether the shellfish are being relayed for direct marketing or for South Carolina Department of Natural Resources planting credit purposes.

(d) Shellfish relayed from a restricted or conditionally restricted area to an approved area for subsequent harvesting for direct marketing purposes shall remain planted for a period of not less than fourteen (14) consecutive days when the water temperature is above fifty (50) degrees Fahrenheit [ten (10) degrees Centigrade]. If the water temperature is less than fifty (50) degrees Fahrenheit, the Department shall make a determination as to an adequate time period to ensure natural purification. Shellfish relayed from a restricted area to a conditionally approved area for direct marketing purposes shall remain planted for a period of not less than fourteen (14) consecutive days when the water temperature is above fifty (50) degrees Fahrenheit and the area is in an open status. If the water temperature is less than fifty (50) degrees Fahrenheit, or if the area is downgraded to a closed status, the Department shall make a determination as to an adequate time period to ensure natural purification.

(e) Shellfish relayed for planting credit purposes shall remain planted for a minimum of four months.

(f) Shellfish relayed to approved or conditionally approved areas shall not be re-harvested until authorized by the Department.

(g) Areas to which shellstock are relayed shall be readily identified and marked. These areas shall be situated in a manner to avoid contamination of shellstock in adjacent growing areas.

2. Interstate Relaying. Shellstock shall not be relayed from the State to another state without prior approval of the Department and the responsible state agency that will receive the shellstock. The United States Department of Health and Human Services, Food and Drug Administration, shall be informed of such interstate activities.

3. Wet Storage. Harvested shellstock may be held in wet storage in approved shellfish growing waters or land-based ponds or tanks where effective control measures are enforced to keep shellfish fresh and protected from contamination. Proper shellstock identification as outlined in item C.1.(c)(1) must be maintained during wet storage.

(a) Permit Requirements. Prior to the wet storage of molluscan shellfish in approved near-shore growing waters, application for a Wet Storage Facility Operating Permit shall be made to and obtained from the Department. Prior to the construction, expansion or modification of any land-based wet storage facility, application for a Wet Storage Facility Construction Permit shall be made to, and a Wet Storage Facility Construction Permit obtained from, the Department. Prior to operating any land-based wet storage facility, application for a Wet Storage Facility Operating Permit shall be made to and obtained from the Department. Wet Storage Operating Permits shall be issued only in conjunction with a Certified Shipper Certificate.

(b) Wet Storage in approved near-shore shellfish growing waters - Operating Permit Requirements. Information related to the proposed construction and operation of a near-shore wet storage facility shall be submitted for Department review and approval. This information shall be provided in the form of a written operational plan detailing the scope and extent of the proposed activity, including, but not necessarily limited to location, type of construction, and species of shellfish stored. The operational plan shall address the following:

- (1) the purpose of the wet storage activity, such as holding, conditioning, or increasing the salt content of shellstock;
- (2) any species specific physiological factors that may affect design criteria;
- (3) location of near-shore storage structures;
- (4) details of the design and proposed construction of the storage structures that address the following minimum construction standards to:
 - (a) allow the free flow of water to shellfish; and
 - (b) be constructed of non-toxic materials; and
 - (c) be constructed so as to protect shellfish from physical, chemical or thermal conditions that may compromise shellfish survival, quality or biological activity.

(c) The Department shall issue an operating permit after approval of the operational plan and completion of a satisfactory Department inspection of the constructed facility.

(d) Wet Storage in land-based ponds or tanks.

(1) Construction Permit Requirements. An Operational Plan shall be provided in conjunction with the Wet Storage Facility Construction Permit application. The Operational Plan shall address the following:

- (a) the purpose of the wet storage activity, such as holding, conditioning or increasing the salt content of shellstock;
- (b) any species-specific physiological factors that may affect design criteria;
- (c) details of the design and proposed construction of the onshore storage facility as required by item D.3(d)(2), source, quantity and quality of water to be used for wet storage as required by item D.3(d)(3), and details of the design and proposed construction of any water treatment system.

(2) Construction Requirements. Each land-based wet storage operation shall meet the following design, construction, and operating requirements:

(a) Effective barriers shall be provided to prevent entry of birds, animals, and vermin into the area.

(b) Storage tanks and related plumbing shall be fabricated of non-toxic material and shall be easily cleanable.

(c) Tanks shall be constructed so as to be easily accessible for cleaning and inspection, self-draining and fabricated from nontoxic, corrosion resistant materials.

(d) Plumbing shall be designed and installed so that it can be cleaned and sanitized on a regular schedule, as specified in the operating procedures.

(e) Storage tank design, dimensions, and construction shall be such that adequate clearance between shellstock and the tank bottom can be maintained.

(f) Shellstock containers, if used, shall be designed and constructed so that the containers allow the free flow of water to all shellstock within a container.

(g) Buildings. When a building is used for the wet storage operation:

(i) Floors, walls, and ceilings shall be constructed in compliance with the applicable provisions of Chapter I;

(ii) Lighting, plumbing, water and sewage disposal systems shall be installed in compliance with applicable provisions of Chapter I.

(h) Outdoor Tank Operation. When the wet storage operation is outdoors or in a structure other than a building, tank covers shall be used. Tank covers shall:

(i) Be constructed of a light colored material;

(ii) Prevent entry of birds, animals or vermin;

(iii) Remain closed while the system is in operation except for periods of tank loading and unloading, or cleaning.

(3) Water Supply.

(a) The quality of source water prior to treatment shall meet, at a minimum, the bacteriological standards for the restricted classification.

(b) Any well used as source water for wet storage shall be constructed, operated and maintained in accordance with all applicable Departmental regulations.

(c) Except when the source of the water is a growing area in the approved classification, a water supply sampling schedule shall be included in the dealer's operating procedures and water shall be tested according to the schedule.

(d) Results of water samples and other tests to determine the suitability of the water supply shall be maintained for at least two (2) years.

(e) Disinfection or other water treatment such as the addition of salt cannot leave residues unless they are Generally Recognized as Safe (GRAS) [see Title 21 Code of Federal Register (21CFR) (April 1, 2007)] and unless they do not interfere with the shellstock's survival, quality or activity during wet storage.

(f) Disinfected water entering the wet storage tanks shall have no detectable levels of the coliform group as measured by a recognized multi-tube MPN test per one hundred (100) ml. for potable water.

(g) When the laboratory analysis of a single sample of disinfected water entering the wet storage tanks shows any positive result for the coliform group, daily sampling shall be immediately instituted until the problem is identified and eliminated.

(h) When the problem that is causing disinfected water to show a positive result for the coliform group is eliminated, the effectiveness of the correction shall be shown on the first operating day following correction through the immediate collection, within a 24-hour period, of a set of three samples of disinfected water and one sample of the source water prior to disinfection.

(i) For water that is disinfected by ultra-violet treatment, turbidity shall not exceed twenty (20) nephelometric turbidity units (NTUs) measured in accordance with Standard Methods for the Examination of Water and Wastewater, APHA.

(ii) The disinfection unit(s) for the water supply shall be cleaned and serviced as frequently as necessary to assure effective water treatment.

(i) Continuous Flow-through Systems.

(i) If the system is of continuous flow-through design, water from a growing area classified as:

(a) Approved may be used, without disinfection, in wet storage tanks provided that the near-shore water source used for supplying the system meets the approved classification bacteriological criteria at all times that shellstock are being held in wet storage; or

(b) Other than approved may be used if the source water is continuously subjected to disinfection and it is sampled daily following disinfection.

(ii) When a source classified as other than approved is used, a study shall be required to demonstrate that the disinfection system will consistently produce water that tests negative for the coliform group under normal operating conditions. The study shall:

(a) Include five sets of three samples from each disinfection unit collected for five consecutive days at the outlet from the disinfection unit or at the inlet to at least one of the wet storage tanks served by the disinfection system;

(b) Include one sample daily for five consecutive days from the source water prior to disinfection;

(c) Use NSSP recognized methods to analyze the samples to determine coliform levels;

(d) Require all samples of disinfected water to be negative for the coliform group;

(e) Be repeated if any sample of disinfected water during the study is positive for the coliform group.

(iii) Once sanctioned for use, the water system shall be sampled daily to demonstrate that the disinfected water is negative for the coliform group.

(j) Recirculating Water System.

(i) A water disinfection system shall be required for all recirculating wet storage systems. A study shall be required to demonstrate that the disinfection system for the recirculating system will consistently produce water that tests negative for the coliform group under all operating conditions. The study shall meet the requirements in item D.3(d)(3)(i)(ii) above.

(ii) Once sanctioned for use, the recirculating water system shall be sampled weekly to demonstrate that the disinfected water is negative for the coliform group.

(iii) When make-up water of more than ten (10) percent of the water volume in the recirculating system is added from a growing area source classified as other than approved, a set of three samples of disinfected water and one sample of the source water prior to disinfection shall be collected within a twenty four (24) hour period to reaffirm the ability of the system to produce water free from the coliform group.

(iv) When multiple tube ultra-violet treatment with redundant capacity is used as a water disinfectant, each time a bulb change is required to replace a burned out bulb, or for periodic servicing, new ultra-violet bulbs shall be installed and old bulbs discarded. When a single tube ultra-violet treatment unit or a multi tube unit without redundancy is utilized, each time a bulb change is required either to replace a burned out bulb or for periodic servicing, new ultra-violet bulbs shall be installed and old bulbs discarded, a set of three (3) samples of disinfected water and one sample of the source water prior to disinfection shall be collected within a twenty four (24) hour period to reaffirm the ability of the system to produce water free from the coliform group. Ultra-violet systems using either a single tube or multiple-tube unit with no redundancy as their disinfection system may utilize an approved ultra-violet wavelength intensity monitoring unit to demonstrate bulb integrity.

4. Depletion of Closed Areas. If depletion of shellfish in a Prohibited Area is more economical than patrolling, all shellfish of market size and as many of smaller size as can be gathered by reasonable

methods may be removed from the area by the Department or under direct supervision of the Department.

5. Shellfish Habitat Preservation. For purposes of shellfish habitat preservation, the Department may, in limited instances and with special conditions, authorize the translocation of viable shellfish beds within prohibited areas. Authorization shall be considered only upon official request from the South Carolina Department of Natural Resources.

E. SHELLFISH SAMPLING AND STANDARDS.

1. Sampling and Testing. Samples of shellfish may be taken for scientific examination for public health purposes at any reasonable time or place by agents of the Department. Samples of shellfish shall be furnished as necessary by processors and operators of facilities, trucks, carriers, stores, restaurants, and other places where shellfish are sold. Receipt for shellfish used for sampling shall be given upon request. The type of test to be performed shall be included on the receipt.

2. Adulteration Standards. In determining bacteriological adulteration of shellfish, the Department shall use an *Escherichia coli* Most Probable Number (MPN) of two hundred and thirty per one hundred grams of sample and a total bacteria count of five hundred thousand per gram. Shellfish containing levels of pathogenic organisms or other substances that render the shellfish potentially unsafe for human consumption shall also be deemed adulterated by the Department.

F. LABORATORY PROCEDURES.

1. General. Laboratory analyses shall be performed by a State laboratory or a laboratory authorized by the Department. Laboratories shall conform to requirements of National Shellfish Sanitation Program Guide for the Control of Molluscan Shellfish Model Ordinance (chapter) III. Laboratory.

2. Microbiological. Methods, practices, and procedures for the analysis of shellfish and shellfish growing or harvest waters shall be the methods required by the National Shellfish Sanitation Program.

3. Physical and Chemical.

(a) Methods for the analysis of shellfish and shellfish growing or harvest waters shall:

(1) Be the current Association of Analytical Chemists (AOAC) or American Public Health Association (APHA) method for all physical and chemical measurements; and

(2) Express results of all chemical and physical measurements in standard units, and not instrument readings.

(b) When an AOAC or APHA method is not available, EPA methods may be used.

4. Biotoxin. Methods for the analysis of shellfish and shellfish harvest waters shall be:

(a) The current Association of Analytical Chemists (AOAC) and American Public Health Association (APHA) methods used in the bioassay for paralytic shellfish poisoning toxins;

(b) The current APHA method used in the bioassay for *Karenia brevis* toxins.

G. CERTIFICATION AND PERMITTING PROCEDURES.

1. General.

(a) It shall be unlawful for any person to shuck, pack, repack, depurate, transport in interstate commerce, or purchase from harvesters or growers, shellfish, who does not possess the appropriate valid certified shipper certificate issued by the Department or other appropriate state shellfish control authority. This item shall not be construed to prevent the transport of non-adulterated shellfish products by common carriers in the hire of a certified shipper, provided shellfish products shall be transported and handled in accordance with applicable provisions of this Regulation.

(b) Certified shipper certificates shall be of the following types:

(1) Shucker-Packer;

(2) Repacker;

(3) Shellstock Shipper;

(4) Reshipper;

(5) Depuration Processor.

(c) It shall be unlawful for any person to sell, offer for sale, distribute for financial consideration, or market shellfish for any purpose related to human consumption that have not been processed by a certified shipper.

(d) Nothing in this section shall be construed to prevent the intrastate distribution or sale of shellfish products for human consumption by persons not possessing a certified shipper certificate issued by the Department, provided, however, that it shall be unlawful for any person who has not been issued a valid certified shipper certificate to:

(1) Sell or offer for sale any shellfish that have not been obtained from a certified shipper;

(2) Sell or offer for sale any shellfish in non-original packaging, and without original tags or labels as affixed by the certified shipper from which the shellfish were obtained, provided, however, that this item shall not apply to persons possessing a valid operating permit issued under authority of South Carolina R.61-25 Retail Food Establishments, provided shellfish have been obtained from a certified shipper;

(3) Transport or store shellfish offered or intended for sale in vehicles that are not constructed, operated, and maintained to prevent contamination and deterioration of shellfish;

(4) Sell or offer for sale adulterated shellfish;

(5) Sell or re-distribute shellfish to certified shippers.

(e) It shall be unlawful for any person to relay, construct or operate a wet storage facility, construct or operate an aquaculture facility, construct a depuration facility, or harvest for depuration who does not possess the appropriate valid permit issued by the Department. Permits shall be of the following types:

(1) Relaying Permit;

(2) Wet Storage Facility Operating Permit;

(3) Wet Storage Facility Construction Permit;

(4) Depuration Harvest Permit;

(5) Depuration Facility Construction Permit;

(6) Aquaculture Facility Construction Permit;

(7) Aquaculture Facility Operating Permit.

2. Application Requirements.

(a) Application for certificates and permits shall be made on forms provided by the Department. Application forms may be obtained by contacting the S.C. Department of Health and Environmental Control, Environmental Quality Control Bureau of Water, 2600 Bull St., Columbia, S.C. 29201.

(b) A construction permit shall be required prior to the construction, expansion, or modification of any depuration, land-based aquaculture, or land-based wet storage facility. Issuance of a valid construction permit shall be required prior to issuance of the associated operating permit.

(c) Application for any activity requiring a construction permit shall include a written operations plan, including construction and site plan, detailing the scope and extent of the proposed construction and associated activity.

(d) Application for aquaculture and wet storage operating permits shall include a written operations plan detailing the scope and extent of the proposed operation.

(e) Application for certification as a depuration processor shall include a scheduled depuration process (operations plan and manual).

(f) Certificates and permits shall be non-transferable.

(g) Certificates and permits, unless otherwise specified, shall expire on June 30 of each year.

(h) Only persons who comply with the requirements of this Regulation shall be entitled to receive and retain a certificate or permit.

3. Issuance of Certificates and Permits.

(a) Certified Shipper Certificates.

(1) Upon receipt of a completed application package, including any required operations plan, the Department shall make comprehensive onsite inspections of the proposed certified shipper facility/operation as may be necessary to determine compliance with the applicable provisions of this Regulation. Inspections shall be conducted within the one hundred twenty (120) day period immediately prior to the issuance or renewal of the certification. Certification shall be issued only for facilities that meet the following requirements:

- (a) Have a Hazard Analysis Critical Control Point (HACCP) plan accepted by the Authority;
- (b) During inspection for certification, have no critical deficiencies (see section H.);
- (c) During inspection for certification, have no more than two key deficiencies (see section H.);
- (d) During inspection for certification, have no more than three other deficiencies (see section H.).

(2) The inspection report recommending initial certification shall include a compliance schedule to correct any key or other deficiencies not corrected by the dealer during the inspection.

(b) Construction and Operating Permits.

(1) Upon receipt of a completed application package, including any required written operations plan, the Department shall, as necessary, make comprehensive onsite inspections of the proposed facility or activity to determine compliance with the applicable provisions of this Regulation.

(2) Permits shall be issued only for facilities and activities meeting applicable requirements of this Regulation.

(3) Any operations plan accepted by the Department in conjunction with the issuance of a construction or operating permit shall not be modified without Department authorization.

H. INSPECTION AND COMPLIANCE.

1. Inspections.

(a) Access. For the purpose of determining compliance with this Regulation, authorized representatives of the Department shall, upon display of proper identification, be permitted to enter at any reasonable time any facility, establishment, market, vessel, or vehicle used to harvest, handle, process, store, sell, or transport shellfish.

(b) Inspection Frequency.

(1) Certified Shippers. Following issuance of a certified shipper certificate, unannounced performance-based inspections shall be made during periods of activity. Inspections and re-inspections shall be made, as determined necessary by the Department, for the effective enforcement of this Regulation. At a minimum, certified shipper facilities shall be inspected in accordance with the following frequencies:

- (a) monthly for Depuration Processors;
- (b) quarterly for Shucker-Packers or Repackers;
- (c) semi-annually for Shellstock Shippers or Reshippers.

(2) Permits. Following issuance of any permit, inspections shall be made during periods of activity as necessary for the effective enforcement of this Regulation.

(c) Records. Authorized representatives of the Department shall, upon display of proper identification, be permitted to examine the records of any facility, establishment, or operation certified or permitted by the Department in accordance with this Regulation, for the purpose of obtaining information pertaining to shellfish grown or harvested, purchased, received, sold, shipped, distributed, shucked, packed, depurated or processed in any manner.

2. Compliance.

(a) National Shellfish Sanitation Program Guide for the Control of Molluscan Shellfish Model Ordinance (chapter) X. General Requirements For Dealers shall be used in establishing and determining Hazard Analysis Critical Control Point (HACCP) and general sanitation requirements.

(b) National Shellfish Sanitation Program Guide for the Control of Molluscan Shellfish Model Ordinance (chapters) XI. Shucking and Packing, XII. Repacking Of Shucked Shellfish, XIII. Shellstock Shipping, XIV. Reshipping, and XV. Depuration shall be utilized in determining

certified shipper inspection item deficiency levels. Deficiencies documented during the inspection of certified shipper facilities shall be corrected in accordance with the following procedures:

- (1) When any inspection detects a critical deficiency:
 - (a) The deficiency shall be corrected during that inspection; or
 - (b) The certified shipper shall immediately cease production affected by the deficiency.
 - (c) If the certified shipper facility fails to correct the critical deficiency during the inspection, the Department shall provide notice of intent to suspend or revoke the certificate.
 - (2) Shellfish products affected by a critical deficiency shall be controlled to prevent contamination or adulterated product from reaching consumers. The Department shall:
 - (a) Condemn and destroy adulterated shellfish;
 - (b) Initiate a recall of adulterated shellfish;
 - (c) Notify enforcement officials for the United States Food and Drug Administration, as well as shellfish control authorities in states that are known to have received adulterated shellfish.
 - (3) When any inspection detects key or other deficiencies not currently covered in a compliance schedule, the Department, working with the certified shipper, shall develop a compliance and correction schedule.
 - (4) When any inspection detects four or more new key deficiencies, the Department shall consider the following options and document the reasons for selection of one of the following options:
 - (a) Revise the existing compliance schedule;
 - (b) Commence action to suspend or revoke certification; or
 - (c) Seek other administrative remedies.
- (c) Nothing in sub-section H.2 shall be construed to limit or make null any option for remedy as provided for in Section P. of this Regulation.
- (d) Stop Sale or Disposal of Shellfish.
- (1) If it has been determined by the Department that shellfish have not been grown, harvested, stored, treated, transported, handled, shucked, packed, processed, sold, or offered for sale in compliance with this Regulation, those shellfish shall be deemed adulterated.
 - (2) Shellfish or shellfish products determined to be adulterated shall be subject to stop sale or disposal by the Department. The Department may temporarily or permanently issue an order to stop sale, condemn, destroy, recall, or otherwise dispose of all shellfish or shellfish containers found to be adulterated.
 - (3) Adulterated shellfish shall be disposed of at the discretion of the Department.
- (e) Suspension or Revocation of Permits or Certificates.
- (1) If the Department has evidence that an operator of a shellfish activity or facility has created or is responsible for conditions that may cause shellfish to become adulterated, the permit or certificate may be suspended or revoked.
 - (2) Serious or repeated violations of any of the requirements of this Regulation, failure to cooperate, or interference with Department personnel in the performance of their duties shall be cause for a permit or certificate to be revoked.
 - (3) Decisions involving the issuance, denial, renewal, modification, suspension, or revocation of permits, licenses, certification, or other actions of the Department shall be in accordance with the provisions of S.C. Code Section 44-1-60, 1976 Code of Laws, as amended.
- (f) Appeal. A Department decision involving the issuance, denial, renewal, modification, suspension, or revocation of permits, licenses, certification, or other actions of the Department may be appealed by the affected person with standing pursuant to applicable law, including S.C. Code Title 44, Chapter 1; and Title 1, Chapter 23.

I. CERTIFIED SHIPPER FACILITIES.

1. General Requirements. In addition to and to the extent not inconsistent with other applicable provisions of this Regulation, certified shippers shall comply with the following sections of the National

Shellfish Sanitation Program Guide for the Control of Molluscan Shellfish Model Ordinance (chapter)

X. General Requirements For Dealers:

- (a) .01 General HACCP Requirements;
- (b) .02 General Sanitation Requirements;
- (c) .03 Other Model Ordinance Requirements;
- (d) .07 Post Harvest Process Labeling; and
- (e) .08 Shipping Documents and Records.

2. Shellfish Source. Certified shippers shall receive and/or process shellfish in accordance with the following:

(a) Shucker-packers, repackers, shellstock shippers, and depuration processors shall only receive or process shellfish that have been:

(1) Harvested from approved or conditionally approved growing areas in the open status, provided that this item shall not apply when closed area harvest has been conducted in conjunction with a special permit issued by the Department; or

(2) Obtained from a certified shipper that has obtained, handled, processed, and transported the shellfish in accordance with the provisions of this Regulation, or another state's substantially equivalent regulation.

(b) Reshippers shall receive shellfish only from certified shippers that have obtained, handled, processed, and transported the shellfish in accordance with the provisions of this Regulation, or another state's substantially equivalent regulation.

3. Shellfish Refrigeration. Certified Shipper facilities shall have non-mobile, mechanically refrigerated storage rooms capable of maintaining all non-frozen shellfish at a temperature of forty-five (45) degrees Fahrenheit (7.2 degrees Centigrade) or less.

4. Shellstock Temperature Control. Certified shippers shall manage shellstock temperature in accordance with the provisions of item C.2(b).

5. Temperature Control. Certified shippers shall control shellfish temperatures in accordance with the provisions of items C.2.(c), C.2.(e) and C.2.(h).

6. Shell stock Identification. Certified shippers shall identify shell stock in accordance with item C.2.(g)(1) of this Regulation.

7. Shucked Shellfish Labeling. Certified shippers shall label shucked shellfish in accordance with item C.2.(i)(1) of this Regulation.

8. Bulk Receiving. When bulk tagged lots of shellfish are received, certified shippers shall use an intermediate processing plan authorized by the Department to ensure shellfish are controlled to prevent commingling or misidentification.

J. SHUCKER-PACKERS.

1. General Requirements. In addition to and to the extent not inconsistent with other applicable provisions of this Regulation, shucker-packers shall comply with dealer requirements of the National Shellfish Sanitation Program Guide for the Control of Molluscan Shellfish Model Ordinance (chapter) XI. Shucking and Packing.

2. Heat Shock. Heat shock shall only be conducted in accordance with a scheduled heat shock process authorized by the Department.

K. REPACKERS.

General Requirements. In addition to and to the extent not inconsistent with other applicable provisions of this Regulation, repackers shall comply with National Shellfish Sanitation Program Guide for the Control of Molluscan Shellfish Model Ordinance (chapter) XII. Repacking Of Shucked Shellfish.

L. SHELLSTOCK SHIPPERS.

General Requirements. In addition to and to the extent not inconsistent with other applicable provisions of this Regulation, shellstock shippers shall comply with National Shellfish Sanitation Program Guide for the Control of Molluscan Shellfish Model Ordinance (chapter) XIII. Shellstock Shipping.

M. RESHIPPERS

General Requirements. In addition to and to the extent not inconsistent with other applicable provisions of this Regulation, reshippers shall comply with National Shellfish Sanitation Program Guide for the Control of Molluscan Shellfish (chapter) XIV. Reshipping.

N. DEPURATION.

General Requirements. In addition to and to the extent not inconsistent with other applicable provisions of this Regulation, depuration processors shall comply with the dealer requirements of National Shellfish Sanitation Program Guide for the Control of Molluscan Shellfish Model Ordinance (chapter) XV. Depuration.

O. SHELLFISH AQUACULTURE.

1. General.

(a) For purposes of this Regulation, aquaculture encompasses the following:

(1) Open-water and/or Land-based operations, other than shellfish seed hatchery operations;

(2) Monoculture (molluscan shellfish) or Polyculture (molluscan shellfish combined with non-molluscan organisms) production.

(b) Any person operating a land based aquaculture facility that grows or produces molluscan shellfish for sale shall obtain the following from the Department prior to commencing operations or harvesting shellfish for human consumption:

(1) An Aquaculture Facility Construction Permit based upon criteria described in the facility's operational plan as required by Section O.4(a); and

(2) An Aquaculture Operating Permit based upon successfully meeting the requirements of all applicable portions of this Regulation; and

(3) Certification as a processor, unless the permitted aquaculturist provides the Department with prior notice that harvested shellfish are to be delivered to a Shucker-Packer (SP), Repacker (RP), Shellstock Shipper (SS), or Depuration Processor (DP) within the State.

(c) Any person operating an open water aquaculture facility that grows or produces molluscan shellfish for sale shall obtain the following from the Department prior to commencing operations or harvesting shellfish for human consumption:

(1) An Aquaculture Operating Permit based upon successfully meeting the requirements of all applicable portions of this Regulation; and

(2) Certification as a processor, unless the permitted aquaculturist provides the Department with prior notice that harvested shellfish are to be delivered to a Shucker-Packer (SP), Repacker (RP), Shellstock Shipper (SS), or Depuration Processor (DP) within the State.

(d) Shellfish aquaculture shall be practiced only in strict compliance with the specific provisions of the Aquaculture Permit.

(e) Applications for Aquaculture Permits must contain a written operational plan detailing the scope and extent of the operation.

(f) Water quality at any site used for aquaculture shall meet the criteria for an approved, conditionally approved, or restricted area classification provided, however, this item shall not apply to shellfish seed operations when:

(1) The use of a prohibited growing area is sanctioned for seed culture operations by the Department;

(2) Prior to relocation, seed cultured in any prohibited area are demonstrated to the Department to have acceptable levels of poisonous or deleterious substances;

(3) Seed cultured in prohibited growing areas are relocated with Department authorization and cultured for a minimum of six months in areas exhibiting approved area criteria; and

(4) Shellfish relocated in accordance with this section shall not be harvested without Department authorization.

(g) Shellfish cultured in any land-based system meeting the criteria for an approved area classification throughout the culture period may be immediately marketed.

(h) Any shellfish raised in aquaculture shall be subjected to relaying or depuration prior to direct marketing if the culture area or facility is located in or using water that is in one of the following:

- (1) A conditionally approved area classification in a "closed" status; or
- (2) A restricted area classification.

(i) Only drugs authorized by the United States Food and Drug Administration shall be used for shellfish treatment.

(j) Complete and accurate records shall be maintained for at least two years by the aquaculturist and shall include the:

- (1) Source of shellfish, including seed;
- (2) Dates of transplanting and harvest; and
- (3) Water source, its treatment method, if necessary, and its quality in land based systems.

(k) Harvesting, processing, storage, and transportation of shellfish shall comply with all other applicable requirements of this Regulation.

2. Seed Source. Aquaculture Permit holders shall provide the Department with documentation concerning the source of seed shellstock.

3. Open Water Operations. Open-water aquaculture operations shall comply with all applicable requirements of this Regulation.

4. Land-Based Operations. Applicants for land-based aquaculture permits shall provide the following to the Department:

(a) A written operational plan that shall include:

- (1) A description of the design and activities of the aquaculture facility;
- (2) The specific site and boundaries in which shellfish culture activities will be conducted;
- (3) The types and locations of any structures, including rafts, pens, cages, nets, tanks, ponds, or floats utilized in the aquaculture operation;
- (4) The species and source of shellfish, including seed, to be cultured and harvested;
- (5) If appropriate, the source and species of other organisms to be cultured in any polyculture systems;
- (6) Procedures to assure that no poisonous or deleterious substances are introduced into the activities;
- (7) A program of sanitation, maintenance, and supervision to prevent contamination of the final shellfish products;
- (8) A description of the water source, including the details of any water treatment process or method, if necessary;
- (9) A program to maintain water quality that includes collection of water samples for microbial analysis, temperature and salinity monitoring, and analytical methods used. The bacterial indicator monitored shall be the same as used for monitoring growing areas;
- (10) Collection of information on the microbial and chemical quality of shellfish harvested from the aquaculture site;
- (11) Collection of data concerning the quality of food produced for use in the artificial harvest system;
- (12) Maintenance of the required records; and
- (13) How shellstock will be harvested, processed if applicable, and sold.

(b) Water Systems.

(1) Water disinfection will not be required if shellfish are held at all times in continuous flow through systems that utilize water from an approved growing area, or from a conditionally approved area in the open status.

(2) Closed or recirculating systems shall:

(a) Not contaminate shellfish with residues that are not Generally Recognized As Safe (GRAS) [see Title 21 CFR (April 1, 2007)]; and

(b) Utilize waters classified as approved, conditionally approved or restricted; and

(c) Be maintained, at a minimum, at the bacteriological quality of the restricted classification.

(3) If the water in the closed or recirculating system is from water classified as conditionally approved, the operational plan shall include a sampling schedule and shellfish shall not be harvested until:

(a) a total of three water samples have been collected from the system a minimum of three days apart over a 14 day period; and

(b) fecal coliform levels in each sample are not greater than fourteen (14) MPN per one hundred (100) ml.

(c) Water Quality.

(1) Shellstock held at all times in waters meeting the criteria for an approved area may be used for direct marketing.

(2) If the water in a closed or recirculating system is from a source classified as conditionally approved and in the open status, shellstock may be marketed directly if the water quality meets a fecal coliform level of less than fourteen (14) MPN per one hundred (100) ml. in each sample collected in the 14 days prior to harvest.

(3) Shellstock in a closed or recirculating system that does not meet the water quality requirements of items O.4(c)(1) or O.4(c)(2) shall be relayed or depurated prior to direct marketing.

5. Polyculture Activities. Aquaculture permit applicants engaging in Polyculture activities shall include in an operational plan provisions to:

(a) Provide information concerning all sources and species of all organisms to be cultivated, cultured, and harvested;

(b) Monitor for human pathogens, unacceptable levels of animal drugs, and other poisonous or deleterious substances that might be associated with polyculture activities; and

(c) Subject all harvested shellstock to relaying or depuration.

6. Mariculture Permit Areas. Operators of shellfish mariculture permit areas permitted by the South Carolina Department of Natural Resources shall provide the Department with a written operational plan that shall include:

(a) A description of activities associated with the operation including, but not limited to, the operational requirements in C.2. (e)(2);

(b) The specific site and boundaries in which shellfish culture activities will be conducted;

(c) The types and locations of any structures, including rafts, pens, cages, nets, tanks, ponds, or floats utilized in the aquaculture operation;

(d) The type and source of shellfish, including seed, to be cultured and harvested;

(e) Documentation of the source of seed shell stock

(f) Record keeping to document compliance with the requirements described in item C.2.(e)(2) for maricultured shellfish harvested during months that do require additional temperature controls.

P. REMEDIES.

1. General. In addition to the provisions herein for administrative suspension or revocation of operating permits, the Department may, at its discretion, bring civil court proceedings to enforce provisions of this Regulation, and may also seek to impose criminal sanctions for violation of this Regulation.

2. Criminal Liability. Violation of any provision of this Regulation shall be punishable in accordance with Section 44-1-150 and Section 44-1-151, Code of Laws of South Carolina, 1976, and any subsequent amendments.

HISTORY: Amended by State Register Volume 21, Issue No. 2, eff February 28, 1997; State Register Volume 24, Issue No. 5, eff May 26, 2000; State Register Volume 31, Issue No. 2, eff February 23, 2007; State Register

Volume 32, Issue No. 6, eff June 27, 2008; State Register Volume 39, Issue No. 6, Doc. No. 4483, eff June 26, 2015; State Register Volume 41, Issue No. 4, Doc. No. 4736, eff April 28, 2017; State Register Volume 41, Issue No. 5, Doc. No. 4736, eff May 26, 2017 (errata).

61–49. Repealed.

HISTORY: Former Regulation, titled Crabmeat, Repealed by State Register Volume 40, Issue No. 5, Doc. No. 4567, eff May 27, 2016.

61–50. Natural Public Swimming Areas.

TABLE OF CONTENTS

SECTION A - PURPOSE AND SCOPE

SECTION B - DEFINITIONS

SECTION C - APPLICATION FOR INITIAL OPERATING CERTIFICATE

1. Applicability
2. Initial Operating Certificate
3. Swimming Area Delineation
4. Restroom Facilities
5. Signs
6. Sanitary Survey
7. Initial Monitoring

SECTION D - ANNUAL OPERATING CERTIFICATE

1. Applicability
2. Annual Operating Certificate
3. Swimming Area Delineation
4. Restroom Facilities
5. Signs
6. Routine Monitoring
7. Closure

SECTION E - ENFORCEMENT

1. Applicability
2. Penalties

SECTION F - SEVERABILITY

A. PURPOSE AND SCOPE.

This regulation will implement a consistent water quality monitoring program to help ensure acceptable water quality in designated freshwater natural swimming areas. The regulation will define a bacteriological sample limit for acceptable water quality. It will also establish a consistent routine monitoring schedule for the facilities. The regulation will allow for closure of areas identified as exceeding the defined bacteriological standard. Closed areas will reopen when acceptable water quality is verified.

B. DEFINITIONS.

1. “Annual Operating Certificate” means a certificate issued by the Department for single season operation of an existing natural swimming area.
2. “Approved Methodology” means an EPA approved method in accordance with requirements of the Clean Water Act or the Safe Drinking Water Act.
3. “Certified Laboratory” means a laboratory certified by the Department.
4. “Department” means the South Carolina Department of Health and Environmental Control.
5. “Initial Operating Certificate” means a certificate issued by the Department for operation of a newly constructed facility.

6. "Natural Swimming Area" is an area where there is a fee or membership required to gain access to a natural freshwater location where swimming is promoted, or a natural freshwater location where improvements have been made to promote swimming. Areas where access is based solely on residence are excluded.

7. "Sanitary Survey" means a comprehensive survey of the topographic drainage area surrounding the natural swimming area to determine possible sources of pollution or any discharge which may adversely affect the quality of water in the swimming area.

C. APPLICATION FOR INITIAL OPERATING CERTIFICATE:

1. **Applicability.** This section is applicable to all new construction of a natural swimming area.

2. **Initial Operating Certificate.** No newly constructed facility may begin operation without receiving an initial operating certificate issued by the Department. Application for the certificate must be made utilizing a form supplied by the Department. Application will include submittal of a facility site map.

a. An initial operating certificate may be issued by the Department if all requirements listed in paragraphs three (3) through seven (7) below have been met and are deemed satisfactory.

b. If sample results show a bacteriological level that exceeds the set standard, a certificate may be issued only if additional facility sampling and lab analysis indicates that the water quality meets requirements as listed in paragraph seven (7) below.

3. **Swimming Area Delineation.** All Natural Swimming Areas shall be required to define the perimeter of the swimming area by rope and buoy, natural barrier or other distinguishable method.

4. **Restroom Facilities.** Functional restrooms must be provided within two-hundred (200) feet of the swimming area. Restroom facilities must be built in accordance with the local building codes.

5. **Signs.** Facilities that do not utilize lifeguard protection during operating hours are required to post a sign(s) at entrances to the swimming area. The sign(s) must state as a minimum that "No lifeguards are on duty at this swimming area."

6. **Sanitary Survey.** The Department shall conduct a sanitary survey to evaluate potential sources of pollution. The survey may include the collection of bacteriological samples. Pollution sources may include, but are not limited to:

- a. Discharges from sewage treatment plants, sewage pumping stations, storm drain outfalls, municipal waste and failing on-site sewage disposal systems
- b. Natural storm water discharges
- c. Industrial, municipal, and commercial site discharges
- d. Agricultural runoff
- e. Discharges at marinas
- f. Concentrated domestic or wild animal populations
- g. Runoff from nearby landfills
- h. Urban runoff
- i. Other nonpoint source runoff

7. **Initial Monitoring.** The facility owner or his/her designated agent shall conduct initial bacteriological sampling of the swimming area. All samples collected must be analyzed by a certified laboratory in accordance with an EPA approved methodology resulting in the enumeration of E. coli bacteria using most probable number (MPN) methodology. Samples shall be collected in a location representative of the swimming area and a minimum of one (1) of the samples shall be collected following a rainfall event. Based on a statistically sufficient number of samples (generally not less than five (5) samples equally spaced over a 30-day period), the geometric mean of the indicated bacterial densities shall not exceed the following:

E. coli sample: 126 MPN per 100 ml;

nor shall more than 10% of the total samples exceed 349 MPN per 100 ml.

D. ANNUAL OPERATING CERTIFICATE:

1. **Applicability.** This section is applicable to all existing natural swimming areas that have previously been issued an initial operating certificate.

2. **Annual Operating Certificate.** No natural swimming area may operate without receiving an annual operating certificate issued by the Department. Application for the certificate must be made utilizing a form supplied by the Department. Prior to receiving the certificate, requirements of paragraphs three (3) through five (5) listed below must be met. Additionally, it shall be verified that a minimum of one (1) satisfactory bacteriological sample has been collected in the swimming area. The criteria listed in paragraph 6(a) below shall be used to determine a satisfactory sample result. Samples used in determining issuance of the operating certificate shall be collected within two weeks of the beginning of facility operation. All samples collected during this two week time frame shall be submitted to or verified by the Department. When all of the above items have been deemed acceptable, the Department will issue an annual operating certificate. An operating certificate is not valid for more than one (1) year and expires not later than December thirty-one (31) on the year of the issuance of the certificate. Operating certificates are the property of the Department and must be returned to the Department if so requested.

3. **Swimming Area Delineation.** All Natural Swimming Areas shall be required to define the perimeter of the swimming area by rope and buoy, natural barrier or other distinguishable method.

4. **Restroom Facilities.** Functional restrooms must be provided within two-hundred (200) feet of the swimming area. Restroom facilities must be built in accordance with the local building codes.

5. **Signs.** Facilities that do not utilize lifeguard protection during operating hours are required to post a sign(s) at entrances to the swimming area. The sign(s) must state as a minimum that "No lifeguards are on duty at this swimming area."

6. **Routine Monitoring.** Routine monitoring shall be conducted by the facility owner or their designated agent. All samples collected must be analyzed by a certified laboratory in accordance with an EPA approved methodology resulting in the enumeration of E. coli bacteria using most probable number (MPN) methodology. The following single sample limit shall apply as the acceptable routine sample standard.

a. E. coli sample: A single sample maximum of 349 MPN per 100 ml.

b. Samples shall be collected in a location representative of the swimming area. No less than two sampling events shall be conducted every month while the swimming area is in operation. Sampling events shall occur no more than fourteen (14) days apart.

c. The Department shall be notified by the facility owner or his/her designated agent should a sample result exceed the limit as established in paragraph 6(a) of this section. This notification must be received within 24 hours of an owner or his/her designated agent's knowledge of the exceeded sample limit.

d. A copy of results from all samples collected shall be submitted to the Department by the end of every month.

7. **Closure.**

a. The facility owner or their designated agent shall immediately close the swimming area should sampling results exceed the sample standard as set forth in paragraph 6(a) of this section. The Department will verify that closure procedures have been followed, as necessary, in the above instance. Operation may be reinstated when the sample results return to an acceptable limit. The facility must keep a record of sampling results including written documentation of closure and reopening dates and times.

b. When a scheduled time limit has been exceeded for compliance with any part of this regulation, the Department may immediately require closure of the natural swimming area.

c. When a health hazard is identified by any dangerous contaminant or condition, the Department shall immediately require closure of the natural swimming area.

E. **ENFORCEMENT:**

1. **Applicability.** This section is applicable to all new and existing natural swimming areas.

2. **Penalties.** Penalties for noncompliance with this regulation will be in accordance with procedures outlined in the SC State Law that governs natural swimming areas.

F. SEVERABILITY:

If any provision of this regulation or its application to any person or circumstance is held invalid, the invalidity does not affect other provisions or applications of the regulation which can be given effect without the invalid provision or application, and to this end the provisions of the regulation are severable.

HISTORY: Amended by State Register Volume 23, Issue No. 2, eff February 26, 1999; State Register Volume 40, Issue No. 5, Doc. No. 4570, eff May 27, 2016.

61–51. Public Swimming Pools.

(Statutory Authority: § 44–55–2310 et seq.)

CONTENTS

- A. DEFINITIONS
- B. CONSTRUCTION AND OPERATING PERMITS
- C. GENERAL CONSTRUCTION REQUIREMENTS FOR ALL PUBLIC SWIMMING POOLS
- D. PUBLIC SWIMMING POOL DESIGN REQUIREMENTS FOR TYPE “A” AND “B” POOLS
- E. DESIGN REQUIREMENTS FOR TYPE “C” POOLS
- F. DESIGN OF TYPE “D” POOLS
- G. DESIGN OF TYPE “E” POOLS
- H. DESIGN OF TYPE “F” POOLS
- I. EQUIPMENT CHANGES AND ALTERATIONS
- J. OPERATION AND MAINTENANCE FOR ALL TYPE POOLS
- K. POOL CLOSURES AND ENFORCEMENT
- L. PRIOR REGULATIONS
- M. EFFECTIVE DATE

A. DEFINITIONS

1. “Alteration” means any change in equipment or materials used in the construction of a public swimming pool, after completion which does not conform to the original, permitted plans, specifications, and change orders. Alterations include, but are not limited to, such items as pool or deck resurfacing, painting, equipment changes, and structural additions or deletions.

2. “ASSE” means the American Society of Sanitary Engineering.

3. “Attendant” means a person, 16 years of age or older, who supervises or controls the entrance, exit or other activities of pool patrons. An attendant may not act as a lifeguard.

4. “Automatic Controller” means integrated electrical/electronic equipment, connected to chemical feed equipment, to continuously monitor and control the pH level and chlorine/bromine (O.R.P method or other method acceptable to the Department) residual of swimming pool water.

5. “Bulk Storage” means any chemical storage container greater than fifteen (15) gallons of liquid, or solid chemical greater than the maximum capacity of the feeder.

6. “Certified Public Pool Operator” means someone who holds a valid South Carolina Pool Operator Certificate from a party approved by the Department.

7. “Change Order” means written notification submitted to the Department on a Swimming Pool Change Order Request Form detailing any proposed pool interior coatings, equipment changes or material alterations which do not conform to the original approved plans, specifications, or previously approved change order.

8. “Competition Pool” means a pool designed to be routinely used to host organized swim competitions such as those sponsored by colleges, universities, swim leagues, and swim clubs.

9. “Coping” means the covering which joins the top of the pool wall with the pool decking and is considered part of the minimum pool deck width requirement. If cantilevered deck is employed, the last twelve (12) inches of this deck next to the pool wall shall be considered coping.

10. "Contiguous" means within a one (1) foot horizontal distance.
11. "Department" means the South Carolina Department of Health and Environmental Control.
12. "Diatomaceous Earth" is a type of filter media that is obtained from the fossil remains of microscopic marine plants and is used in a thin coating over filter septa or bags.
13. "Disinfection Equipment" means any device used to supply approved disinfectants to the pool water.
14. "Elevated Structure" means any structure located within a ten (10) foot horizontal distance from the pool edge, which is intended for patron access, and may unintentionally serve as a raised platform for diving or jumping into a pool. This includes, but is not limited to elevated walkways, stairs and landings, balconies, or any construction which is interpreted by the Department as a structure intended for use by patrons that could be used for diving or jumping into a pool. This does not include pool equipment designed for, and approved by the department to be used for diving or jumping into a pool.
15. "Emergency Equipment" means a backboard with straps, two (2) blankets, cervical collars in adult and infant sizes or a commercial head immobilizer.
16. "Filter" means any apparatus containing filter media which is intended to physically remove suspended particles from pool water.
17. "Filter Backwash Piping" means the piping which extends from the backwash outlet of the filter to its terminus at the point of disposal.
18. "Filter Media" means the fine material which entraps the suspended particles as the water passes through the filter.
19. "First Aid Kit" means a water resistant, clearly labeled, latched container providing sufficient first-aid equipment to treat up to fifteen (15) people. The kit will contain as a minimum: alcohol wipes, antibiotic ointment, assorted adhesive bandages, a breathing barrier, a cold pack, gauze, and disposable gloves.
20. "Flow Meter" means a device installed on the pool return pipe (discharge line from filter) to indicate recirculation flow of the pool in gallons per minute (gpm).
21. "gpm" means gallons per minute.
22. "Hand feeding" means the dispensing of any pool chemical manually into the pool.
23. "Heater" means a device through which pool water is circulated to increase the temperature of the water which is specifically designed for pool or spa use.
24. "Hose Bibb" means water faucet with male screw threads to which a hose is attached.
25. "Hybrid Pool" means any pool that has multiple intended use zones such as kiddie play zones, slide landing zones, lazy river zones, and swim zones.
26. "Hydrostatic Relief Valve" means a device, usually installed in the main drains, used to relieve ground water pressure imposed on the outer shell of the pool.
27. "Kiddie Play Park" means wading (kiddie) or spray pools intended to be used exclusively by children where climb-on toys and attractions are provided.
28. "Lifeguard" means a person having the qualifications of and possessing a current American Red Cross, YMCA, or equivalent Lifeguard Certificate, current First Aid Certificate and current CPR (which includes adult, child, and infant) Certificate.
29. "Lifeline Anchors" means the devices recessed in the wall of the pool at the transition point between shallow and deep areas.
30. "Life Saving Equipment Unit" means a coast guard approved ring buoy at least twenty (20) inches in diameter attached to a throwing line having a length of one and one-half (1 1/2) times the width of the pool up to a fifty (50) feet maximum length of rope and a life hook of the shepherd's crook style with minimum twelve (12) foot handle attached with stainless steel nut and bolt. For Type "A" and "E" pools a rescue tube may be used in place of a shepherd's crook and life ring.
31. "Main Body of the Pool" means the major portion of the pool body excluding any recesses, niches, coves, etc.

32. "Main Drain" means the outlet(s) at the bottom of the pool. These outlets are suction/gravity outlets connected to the recirculation piping.

33. "Main Drain Piping" means the piping connecting the main drain to either the pump suction, surge tank, or the vacuum filter.

34. "Major Fraction" means twenty-five percent (25%) or more.

35. "Minimum Flow Rate" means the least flow of water through the water treatment system that must be maintained to provide adequate treatment and is calculated by dividing the volume of the pool, in gallons, by the required turnover time, in minutes (gallons/minutes).

36. "Normal Operating Level" means the water level at one-half (1/2) the skimmer throat depth or at the gutter lip.

37. "Non-Slip" means having a coefficient of friction of 0.6 or greater when wetted for manufactured tile; or broom finish or other textured finish for concrete as recognized by the American Concrete Institute; or for other surfaces, incorporated features designed to prevent slippage.

38. "Obstruction" means any structure or object which blocks or limits access to the perimeter area of the pool. This includes but is not limited to planters, walls, water features, pillars, etc.

39. "Overflow Gutter" means a device at the normal water level which is used as an overflow and to skim the pool surface, in lieu of a surface skimmer.

40. "Owner" means the owner of the facility or his/her designated agent such as a property manager or on-site representative.

41. "Pool Area" means any area located within the fenced perimeter of the pool to include but not limited to the pool deck. The pool deck will define this area for facilities which do not have a perimeter fence. Where a fence is not required the pool area will include but not be limited to the pool deck.

42. "Pool Deck" means the paved area around the pool which is specifically constructed for use by swimmers.

43. "Pool Depth" means the distance between the floor of the pool and the normal operating level when the pool is in use.

44. "Portable Kiddie Slide" means a single flume slide with a starting height no greater than five (5) feet above the deck, made as a complete unit by a single manufacturer, and intended for use by children, which may be moved when not in use.

45. "Public Swimming Pool or pool" means an artificial structure either above or below the ground surface to provide for such recreational uses as bathing, swimming, diving, wading, spraying, sliding, floating, rafting, or other similar usage which is not built in connection with a single family residence, or duplex (two living units within a single structure) and the use of which is not confined to the family of the residence and their private guests, or which is not owned, constructed, operated, or maintained by a church, synagogue, or religious organization, or facility exempted under Title 45, Chapter 4, of the South Carolina Bed and Breakfast Act. Public swimming pools are listed in the following categories based upon specific characteristics of size, usage, and other factors:

(a) Type "A" means any pool open to the general public, except for Type "E" pools, which does not require a membership or that a person be a guest of a member to gain entrance to the pool, or is not operated solely for and in conjunction with a residential development or a place of lodging.

(b) Type "B" means swimming pools at hotels, motels, apartments, mobile home parks, condominium developments, country clubs, schools, swim clubs, health clubs, campgrounds, subdivisions and other pools of similar usage. Lazy rivers constructed at the above facilities shall be considered Type "B" pools.

(c) Type "C" means wading pools, kiddie pools, spray pools, spray decks, or wet decks. Spray decks, splash pads, or wet decks that use water from a public water system, as defined by R.61-58 State Primary Drinking Water Regulations, and do not recirculate the water are exempt from these regulations.

(d) Type "D" means spa pools and hot tubs. Rehabilitation or therapy pools located at hospitals, sports therapy clinics, doctors offices, or other medical facilities which will be used solely

for therapy and rehabilitation purposes and under the supervision of a physical therapist or other qualified medical personnel are excluded from this regulation.

(e) Type "E" means those pools at water parks such as water flumes, water slides, lazy rivers, wave parks, inner tube rides, kiddie play parks, etc. Type "E" also means pools at subdivisions that have a slide that is in use, or not able to be secured to prevent access when not in use. If the slide can be secured to prevent access when not in use, the pool may be open as a type "B" pool when the slide is not in operation and secured.

(f) Type "F" means special purpose pools used exclusively for limited activities such as scuba diving lessons, helmet diving lessons, underwater work training, or similar, limited uses.

(g) Type "G" means hybrid pool.

46. "Recirculation Piping" means the piping from the pool to the filter and return to the pool, through which the water circulates.

47. "Recirculation Pump" means the pump(s) that provide for complete recirculation of pool water through the recirculation piping and filter(s) at a prescribed rate of turnover.

48. "Recirculation System" means a system consisting of pumps, motors, piping, filters, inlets, outlets, disinfecting and other water conditioning equipment and necessary accessories.

49. "Residential Swimming Pool" means any privately owned swimming pool which is built in connection with a single family residence, the use of which shall be confined to the family of the owner and his guests, shall not include any type of cooperative housing or joint tenancy of two or more families, and shall be located within the same property boundary as the family dwelling building to which it serves. Pools constructed in conjunction with a single family rental unit will be considered a residential pool.

50. "Return Inlets" means the fittings or openings through which water is returned to the pool.

51. "Return Piping" means the piping which carries the filtered water under pressure from the filter to the pool.

52. "Shallow End of Pool" means the portion of the pool with water depths of four (4) feet or less.

53. "Spray Pool" or spray deck or wet deck means an artificial structure used to impound water either above or below the ground surface into which treated water is sprayed and recirculated.

54. "Surface Skimmer" means a device used to skim the pool over a self-adjusting weir.

55. "Surface Skimmer Piping" means the piping that carries water from the skimmer to the pump suction, to include the equalizer piping.

56. "Surge Tank" means an approved fixture or device of such material, shape, and capacity as to adequately receive the surge water from indirect or direct overflows, so constructed and located as to be easily cleaned.

57. "Technical Assistance Visit (TAV)" means a comprehensive on-site evaluation by the Department of a public pool to include pool area and associated equipment, operation and maintenance, and a review of current season inspections.

58. "Transition Point" means the point in a pool where the slope changes from one (1) ft. vertical to ten (10) ft. horizontal (1:10) maximum to one (1) ft. vertical to three (3) ft. horizontal (1:3) maximum. This point may separate the deep end from the shallow end.

59. "Turnover Time" means the period of time (usually hours) required to circulate the complete volume of water in a pool through the recirculation system.

60. "Vacuum Outlets" means the fitting in the pool which is used as an outlet for connecting the underwater suction cleaning equipment.

61. "Vacuum Piping" means the piping which connects the vacuum fitting to the pump suction.

62. "Vertical" is interpreted to permit poolside wall slopes not greater than one foot horizontal for each five feet of height of the poolside wall (79 degrees).

63. "Wading (Kiddie) Pool" means a pool intended to be used exclusively by children for wading.

64. "Water Course, Water Slides or Water Flumes" means any pool using a water flume, channel, or slide for purposes of sliding and landing in an area filled with water (this does not include commercially manufactured swimming pool sliding boards).

65. "Well-Point System" means perforated pipe(s) placed in a gravel pit under the deepest point of the pool, where a pump may be connected to remove excess ground water from beneath the pool.

66. "Zero Depth Entry Pool" means a pool with a starting water depth of zero (0) feet which uniformly slopes to a deeper water depth.

67. "Zone" means any pool use type as it relates to the intended use of a specific portion of a hybrid pool (kiddie play zones, slide landing zones, lazy river zones, and swim zones). Zone areas and volumes must be clearly delineated on the plans and specifications.

B. CONSTRUCTION AND OPERATING PERMITS

1. Applicability. Requirements of this section are applicable to all new construction and alterations of existing public swimming pools.

2. Construction Permit. No public swimming pool may be constructed or altered until a permit to construct has been issued by the Department.

3. Application for Permit to Construct. The application must be made on a form supplied by the Department and be accompanied by the appropriate application/review fee. The application must include:

(a) The names, complete address and telephone number of the owner, pool contractor, and facility; contractor's license number and project cost as defined by South Carolina Department of Labor, Licensing, and Regulation, General and Mechanical Contracting Act, Chapter 11, Title 40. The owner must sign the application.

(b) Responsibilities of the owner and pool contractor to include: the swimming pool, deck and coping, equipment room, fence, area lights, bathhouse, minimum toilet facilities, chemical storage room, water lines, hose bibbs and water discharge lines, where applicable.

(c) Details of the pool to include type of pool, perimeter, area, volume, minimum flow rate, design flow rate, total deck area, pool limit and deck limit.

4. Plans and Specifications. At least four (4) copies of complete plans and specifications meeting the following requirements must accompany all applications of permits to construct:

(a) Plans and specifications shall be prepared, stamped, dated and signed by an architect or engineer registered in the State of South Carolina. Once construction starts, the pool contractor must maintain a copy of the DHEC-approved plans and specifications on the job site until the final inspection.

(b) Plans shall be submitted on sheets no larger than thirty-six (36) inches by forty-two (42) inches and no smaller than eighteen (18) inches by twenty-four (24) inches.

(c) Typed or legible specifications shall be submitted on sheets eight and one half (8 1/2) inches by eleven (11) inches or printed on the plans.

(d) Plans and specifications must include data that pertains to that project only (except site plans; which by their nature must include other structures and details). Standard plans and/or specifications with crossed-out sections or inapplicable provisions will not be acceptable for review.

(e) Plans and specifications must include:

(i) A location map with the name of the facility, the location showing distance in miles and local landmarks and the names and addresses of the owners.

(ii) An outlined block for the perimeter, the surface area, the volume, the total deck area, the minimum flow rate, the design flow rate, the swimming limit and the deck limit specifically listed on the plans.

(f) A site plan must be provided consisting of a detailed layout of the facility and the surrounding structures. The site plan must show the distance to toilet facilities, telephone, the location of utilities that affect construction of the pool, elevation differences in the deck and surrounding structures, the location and elevations of planters within 10 feet of the pool edge, etc.

(g) Plan and profile views of the public swimming pool must be shown. These views must be drawn to a minimum of 1/8" scale with all major pool dimensions shown on the drawing. All equipment (fittings, ladders, diving boards, main drains, surface skimmers, overflow gutters, inlets, lights, piping location, fill spout, etc.) shall be clearly located on these views.

(h) A complete equipment list must be included. This list must include manufacturer's name and manufacturer's complete model number (not distributor's name and model number).

(i) Actual layout of deck area including dimensions, showing the location of hose bibbs, footshowers, overflows, depth markers, deck drains, and deck lighting must be provided. Deck material and color must be specified. The quantity of lighting in watts, lumens, or foot candles that will be provided for the deck and pool areas must be provided where night swimming is requested.

(j) Schematic plumbing diagrams showing pipe sizes on each section of pipe, valves, flow meter, heater, filters, pumps, etc. must be shown.

(k) Equipment room plan drawing showing actual layout of equipment (heater, pump, filter, chlorinator, and other equipment), spacing, elevation, all pipe sizes, location and size of sumps, floor drains and other appurtenances with dimensions given and drawn to a minimum 1/4" scale shall be provided. The volume of the equipment and chemical storage rooms must be provided along with the minimum size of the exhaust fans to be installed.

(l) Source of pool water used must be specified.

(m) Disposition of sanitary sewage from the facility must be specified.

(n) Disposition of filter backwash must be specified. Approval from the Department will be required for all discharges.

(o) Complete details of any required bathhouse or minimum toilet facility shall be submitted.

5. Design/Equipment Changes.

(a) New Construction. Once a construction permit has been issued for a public swimming pool, construction must be in accordance with the approved plans and specifications. Should design changes or equipment changes become necessary during construction, a Swimming Pool Change Order Request Form, detailing the proposed changes must be submitted to and approved by the Department prior to initiation of such changes. Revised plans documenting all construction modifications will be required to be submitted prior to the final Department inspection. The submittal must include four (4) complete sets of revised plans that are signed, sealed, and dated by the project architect or engineer.

(b) Existing Facilities. After a pool has received approval to be placed into operation, a Change Order Request Form must be submitted in accordance with Section I for any alteration which does not conform to the original permitted plans, specifications, or previously approved change order.

(c) Fees. The appropriate fee if any must be submitted with the Change Order Request.

6. Piping Inspection. During actual construction of the public swimming pool, after all piping has been installed and before it is covered, the contractor, design engineer, or architect, must notify the Department in writing so that an inspection of all piping, fittings, and other applicable equipment can be conducted to verify their sizes and locations. Pressure testing of the piping must be conducted in accordance with R.61-51.C.24(d). If there are any variations from the approved plans and specifications, such variations must be corrected by the contractor, or plans and specifications detailing the changes must be re-submitted for a construction permit revision prior to continuance of construction.

7. Final Approval. No newly constructed or altered public swimming pool shall be placed into operation until a final inspection of the facility has been conducted and a written approval to be placed into operation is issued by the Department. Before the final inspection can be conducted three (3) letters must be submitted, one by the pool contractor; one by the general contractor, owner or his designated agent; and one by the project architect or engineer; certifying that the public swimming pool, bathhouse, minimum toilet facilities, if required, fence, equipment room, area lighting, if provided, and other applicable items have been constructed according to approved plans and specifications and is ready for the final inspection. All three letters must be received by the Department before a final inspection will be conducted. In addition to the three certification letters,

the engineer and or the architect or their representative must complete a copy of the Department's final inspection checklist, and it must be submitted to the Department prior to the final inspection. A contractor's and owner's representative must be present at the time of the final inspection.

8. Fees. The Department shall collect non-refundable application/review fee(s) with each application according to the schedule outlined in R.61-30, *Environmental Protection Fees*.

9. Repeat Inspections. The Department may collect an additional fee from the contractor for each repeat piping inspection for each pool and from the owner for each repeat final inspection for each pool that is required due to incomplete construction or construction that is not in accordance with permitted plans and specifications as outlined in R.61-30. There will be a mandatory two (2) day (business days) waiting period between all repeat piping, final, and change order inspections to provide for review and rescheduling.

10. Construction Contractor. All new construction and alterations to existing public swimming pools must be performed by a contractor holding a South Carolina license with the appropriate sub-classification in accordance with the South Carolina Department of Labor, Licensing and Regulation's General and Mechanical Contracting Act, Chapter 11, Title 40 as amended.

11. Permit Terms. A permit is valid for one (1) year from the date of issue unless an alternate date is established by the Department. This one (1) year period includes the time it takes to obtain a Final Approval. A permit extension may be granted for up to one year from the date of the request. Extension requests must be submitted on a Change Order Request form and will not be granted if the request is received more than one year from the expiration date of the permit. Up to three permit extensions can be granted. Unless an extension can be granted as provided above, a new application, with the appropriate fee and permit package must be submitted for expired permits.

C. GENERAL CONSTRUCTION REQUIREMENTS FOR ALL PUBLIC SWIMMING POOLS

1. Applicability. Requirements of this section are applicable to all new construction and alterations of existing public swimming pools. All work must be performed in accordance with good engineering practice and recognized industry standards.

2. Water Supply. All water used in public swimming pools, drinking fountains, bathhouse, or minimum toilet facilities, must be supplied from a Public Drinking Water System.

(a) Water for filling pools shall be supplied by a fillspout that is located at least 2 diameters of the fillspout above the rim of the swimming pool or an above the rim supply to the surge tank, whereby no arrangements exist which, under any condition, permits contaminated water to re-enter the potable water system. The fillspout must be located adjacent (no greater than six (6) inches away) to a ladder or under a handrail or diving board and extend to the edge of the coping and not more than one (1) inch past the edge of the coping. All fillspouts must be of chrome plated brass, stainless steel, or other equivalent material approved by the Department.

(b) Where a fillspout is not employed, an approved double check valve assembly in the line supplying water to the pool shall be used. The device must be installed in a location which is accessible for visual inspection and for testing and/or repair. The double check valve assembly must be tested by a certified tester after installation and before use by the customer as required by the South Carolina State Primary Drinking Water Regulations 61-58. Each device used must be from the approved list of backflow prevention devices issued by the Department. The municipality or water utility which supplies the facility and the Department shall be provided a copy of the test results. Kiddie pools may be filled via a hose bibb if it is protected by an ASSE 1024 listed residential dual check or other Department approved backflow prevention device.

3. Sanitary Sewage. The disposition of sanitary sewage from the bathhouse or minimum toilet facilities must be into a sanitary sewer, a septic tank or other waste treatment facility which has been approved by the Department.

4. Location. The location of the pool will in no way hinder the operation for which it is designed nor adversely affect bather's safety or water quality. Outdoor pools must not be located where they will be exposed to excessive pollution by dust, smoke, soot, or other undesirable substances. If any portion of the pool is located within ten (10) feet horizontally of any second story balcony or any other elevated structure of which the floor elevation is between two (2) and thirty (30) feet above the pool deck, a protective barrier must be provided on said balcony or elevated structure. This barrier must be a minimum of five (5) feet in height and have no openings within this barrier

greater than 4 inches in width. Buildings or structures at the pool deck level only within ten (10) feet of the pool waterline that have glazing must utilize tempered safety glass or other shatter resistant safety glazing for any doors and windows. All indoor pools must be located in adequately ventilated areas.

5. Material and Finish.

(a) Public swimming pool shells must be constructed of reinforced concrete or other structurally sound material equivalent in strength and durability, designed and built to withstand anticipated stresses, and designed and built of watertight construction with smooth and impervious surfaces. If a pool structure is to be lined with a dissimilar material, the two materials must be continually and permanently bonded so as not to separate at any time or place. American Concrete Institute standards must be used in design and construction of reinforced concrete including gunite, shotcrete and other types of acceptable concrete. No vinyl lined pools or spas are allowed.

(b) A moderately smooth, non-slip white or light colored water proof finish, which will withstand repeated brushing, scrubbing and cleaning procedures, must line the pool. Paint, fiberglass, or epoxy coated finishes shall be non-toxic, water-resistant, of one single very light color, and must continually and permanently bond so as not to separate at any time. Colors must have reflectance of fifty-five percent or greater except for logos. All corners and edges shall be rounded and smooth to prevent cuts or abrasions to swimmers. All corners and all junctions of walls and floor must be rounded with a minimum six (6) inch radius. Any variation of this required six (6) inch radius must be approved on an individual basis.

(c) A minimum six (6) inch glazed frost proof tile or other easily cleanable surface must be placed at the normal water line.

(d) Logos or extraneous writing or materials shall be approved on an individual basis. Color, size and pattern of logos shall not be such as to obscure the existence or presence of objects or persons within the pool.

6. Pool Decks.

(a) The deck must be continuous around the public swimming pool and unobstructed, with minimum widths as follows:

(i) Type "A" six (6) feet

(ii) Type "B" four (4) feet; Type "B" pools over 1600 square feet, six (6) feet.

(iii) Type "C" four (4) feet

(iv) Type "D" (less than 700 square feet) at least two (2) feet around one hundred percent or four (4) feet around at least fifty percent of the facility. Type "D" (700 square feet to 1600 square feet) at least four (4) feet. Type "D" (greater than 1600 square feet) at least six (6) feet.

(v) Type "E" flumes, slides and lazy rivers ten (10) feet around the exit of the landing pool, four (4) feet around the starting pool. All other Type "E" pools are required to have a minimum of six (6) feet.

(vi) Type "F". Deck widths for Type "F" pools will be determined depending on the use of each pool.

(b) Pool decks required in (a) above must be constructed of broom finish concrete or other material which is as equal in strength and durability. The deck must be non-slip, impervious and no hazard to bare feet. The deck must slope one-quarter (1/4) inch to five-eighths (5/8) inches per foot per foot away from the pool. No wood decking or carpet is allowed within the required minimum deck widths. If concrete pavers are used for pool decking, they must be installed per the Interlocking Concrete Paver Institute (ICPI) code.

(c) A minimum of three (3) feet of deck width must be provided on the sides and rear of any piece of diving or sliding equipment, lifeguard chairs, ladders and handrails. Poolside tables and chairs or other equipment must not obstruct the deck areas within the minimum widths listed for each type pool.

(d) All corners and edges of deck or coping must be smooth and round so as to not cause cuts or abrasions to swimmers. The top of the pool wall must be uniformly level and designed with

bull-nosed coping or some other acceptable means by which an adequate handhold is provided around the entire pool perimeter.

(e) All deck drainage must be “to waste” and not be filtered and returned to the pool. Deck drains must be installed where necessary to prevent standing water on the deck. The deck drain grates shall be removable or provide for other means so as to facilitate the cleaning of the drains.

(f) Hose bibbs must be provided around the perimeter of the deck area at intervals such that all parts of the deck can be reached with a one hundred (100) foot hose. A hose bibb may be located in the equipment room. All hose bibbs in the pool area must be isolated from the public water supply by an ASSE 1024 listed residential dual check or other Department approved backflow prevention device. If a common ASSE 1024 listed residential dual check valve is installed, it must be located in either the equipment room, or in a valve box such that it can be maintained and or replaced as necessary. Also, a shutoff valve must be installed downstream of the backflow device so the Department can verify that all hose bibbs are protected by the common backflow device. All backflow devices must be installed so that they are visible at the time of the final inspection.

(g) All outdoor pools shall be provided with a foot rinse shower at major entrance points, up to a maximum of three (3). The foot rinse shower must be located within twenty (20) feet of the corresponding entrance point.

(h) Up to ten percent (10%) of the pool perimeter may be obstructed. Obstructions shall have the required minimum deck width behind or through them within fifteen (15) feet of the water. These obstructions must be protected by a barrier or must be designed to discourage patron access. When an obstruction exists in multiple areas around the pool the minimum distance between obstructions shall be four (4) feet.

7. Depth Markers. Permanent depth markers must be plainly marked at or above the water surface on the vertical pool wall and on the edge of the coping or deck next to the pool, at a maximum and minimum point and at not more than two (2) foot intermediate increments of depth. Depth markers must also meet the following requirements:

(a) Depth markers must be spaced at not more than twenty five (25) foot intervals on center, as measured around the perimeter of the pool.

(b) A minimum of three (3) sets of evenly spaced depth markers are required for Type “C” and “D” pools.

(c) One set of markers must be located adjacent to the steps or handrail.

(d) Depth markers must be in numerals and letters of four (4) inch minimum height and of a light-colored background (that is, having a reflectance of fifty-five (55) percent or greater) with dark, contrasting lettering. Alternative designs, having sufficient contrast, will be considered on case-by-case basis.

(e) Depth markers must be accurate to within three (3) inches at normal operating level

(f) The abbreviation “ft.” or word “feet” must be included.

(g) A total of twelve (12) inches of white background tile must be included as part of each depth marker(s).

(h) Depth markers are required for all pools, kiddie pools, spas, hot tubs, special water park pools, etc. Kiddie spray decks do not require depth markers.

(i) Depth markers on the deck must be non-slip and must start within fifteen (15) inches of the pool edge.

(j) In pools requiring “No Diving” signs, a single six inch by six inch universal no diving tile must be co-located with each set of deck depth marker tiles.

(k) Metric depth markers may be installed at any facility in addition to the standard markers required above.

(l) Depth markers for pools with multiple slopes (bowl shaped and diving wells) must accurately reflect the minimum depth at the edge of the pool and the maximum depth at the center of the pool and separated by a hyphen. For example, a pool sloping from all sides to the center would require the installation of the following depth markers, “3 FT - 5 FT”.

(m) Alternative types of depth markers will be considered on a case by case basis for pools using stainless steel gutters or fiberglass shells.

(n) Depth markers shall be verified by measuring the depth at a distance of two (2) feet from the edge of the pool.

8. Fences.

(a) All outdoor Type "A" and "E" public swimming pools (including the deck area) must be enclosed by a chain link fence or equal barrier of minimum six (6) foot height to prevent trespassing and to provide safety and cleanliness of the water. Type B and Type E pools that have a slide that is only in use when lifeguards are present must have the entry and exit points of the slide secured by either a six (6) foot high fence, or another method approved by the Department. All openings in the barrier must be equipped with gates or doors, with latches, that close automatically and can be locked. No openings in the fence shall be large enough for a four (4) inch sphere to pass. Local building codes for the pool location may require a smaller fence opening.

(b) All outdoor Type "B", "C", "D" and "F" public swimming pools (including the deck area) shall be enclosed by a minimum four foot fence as measured from the exterior of the pool area. All openings in the barrier must be equipped with gates or doors, with latches, that close and latch automatically and can be locked. Courtyard fencing may not be adequate to constitute fencing of the pool area. No openings in the fence shall be large enough for a four (4) inch sphere to pass. Local building codes for the pool location may require a smaller fence opening.

9. Equipment Room.

(a) A suitable equipment room shall be provided to house all pool equipment to prevent unauthorized access. The room shall be of substantial and enduring construction to protect the equipment from damp, corrosive environment. This room shall have a roof, be at least eight (8) feet high and have a standard size lockable entrance door. Where equipment rooms are constructed at a different elevation than the surroundings, permanent steps should be provided for entry. The equipment room must be sized so that all equipment is accessible for ease of operation and inspection. The equipment room door must be sized to allow for the largest filter in the room to pass through. At least three feet of clear walkway must be provided to allow access to the equipment. The room must have at least one (1) watt of artificial light for each square foot of floor area with a minimum of 100 watts incandescent, or equivalent. Continuously operated forced ventilation must be provided during pool operation so that the equipment room has a minimum of ten (10) complete air changes per hour and is vented to the outside and away from the pool. The light switch must be separate from the fan switch if a fan switch is provided. The floor shall be concrete and shall include necessary sumps. The floors must be sloped to drain to either floor drains or to the sump. All sump pits must be provided with a protective grate or covering capable of supporting a person. Sump pits that are protected by walls extending three (3) feet or more above the floor elevation do not have to have a protective grate. The purpose of this room is for recirculation system equipment only and storage of any other material or equipment is prohibited. Equipment rooms constructed below grade must be provided with reasonable access so as not to be considered a confined space. An emergency disconnect (e.g. shunt trip breaker) switch that disconnects all pumps in the equipment room must be located on the pool deck and clearly labeled with a minimum of four (4) inch red letters on a white background that states "Pool Emergency Cut-Off Switch".

(b) A suitable alternative to the above room will be considered on a case by case basis as long as the pool equipment is protected from a damp and corrosive environment, vandalism, and has adequate access for maintenance.

(c) All equipment must be installed per the manufacturer's recommendations, including equipment clearances.

10. Chemical Storage. All pool chemicals must be housed in a separate room from the equipment room. The chemical storage room must have at least one (1) watt of artificial light for each square foot of floor area with a minimum of 100 watts incandescent or equivalent light. Continuously operated forced ventilation must be provided so that the chemical storage room has a minimum of ten (10) complete air changes per hour and is vented to the outside. The light switch

must be separate from the fan switch if a fan switch is provided. The pool chemical room must be kept dry and locked at all times. Only chemicals used in the operation of the pool shall be stored in this room. Chemical storage rooms constructed below grade must be provided with reasonable access so as not to be considered a confined space.

11. Drinking Fountain. At least one (1) drinking fountain shall be provided within fifty (50) feet of the pool at all public pools. All electrical drinking water fountain wiring must be in accordance with the National Electrical Code (NEC).

12. Emergency Notification Device. A toll free emergency notification device to notify emergency personnel must be provided within a two hundred (200) foot walking distance of the pool and in a location that it is easily accessible during the hours that the pool is in operation. Only permanently-mounted notification devices are acceptable to the Department. Mobile, voice over internet, or cordless telephones are not an acceptable alternative to permanently-mounted emergency notification devices. The physical address of the pool must be displayed at the emergency notification phone or device in a manner that is permanent and weather resistant.

13. Bathhouse Facilities. Dressing and sanitary plumbing facilities must be provided for all Type "A" and "E" public swimming pools that charge for admission. Bathhouse facilities shall be located within two hundred (200) feet of the swimming pool. Applicable Americans with Disabilities Act guidelines shall be observed. Every bathhouse must be provided with separate facilities for each sex with no inter-connection between the male and female facilities. The rooms must be so developed and planned that good sanitation can be maintained throughout the building at all times.

(a) Minimum Fixtures. Minimum sanitary plumbing fixtures for Type "A" and "E" pools must be provided as follows:

(i) Males. One (1) water closet, one (1) lavatory, and one (1) urinal for the first one-hundred (100) male swimmers, or major fraction thereof. One (1) additional water closet, lavatory and urinal must be provided for each additional two hundred (200) male swimmers or major fraction thereof. A minimum of two (2) showers for the first one hundred (100) male swimmers and one (1) shower for each additional fifty (50) male swimmers or major fraction thereof.

(ii) Females. A minimum of two (2) water closets and one (1) lavatory for the first one hundred (100) female swimmers, or major fraction thereof. Two (2) additional water closets and one (1) lavatory must be provided for each additional two hundred (200) female swimmers or major fraction thereof. A minimum of two (2) showers for the first one-hundred (100) female swimmers and one (1) shower for each additional fifty (50) female swimmers or major fraction thereof.

(b) Hose Bibbs. Hose bibbs located at least ten (10) inches above the floor must be provided for washing down the dressing rooms and bathhouse interior. Each hose bibb must be provided with an ASSE 1024 listed residential dual check or other Department approved backflow prevention device.

(c) Floors. The floors of the bathhouse must be of impervious material, relatively smooth but not a slick finish, to ensure complete cleaning. Floor drains must be installed and must be a minimum of four (4) inches in diameter to ensure positive drainage of all parts of the building, with a slope in the floor of not less than one-fourth (1/4) inch per foot, toward the drains. Carpet shall not be used on bathhouse floors.

(d) Materials and Finish. Materials and finishes used in bathhouses and/or restrooms are subject to approval by the Department. All screen, shower, toilet and dressing room booth partitions must be made of durable materials not subject to damage by water and must be so designed that each area can be adequately drained.

(e) Steps. No steps will be allowed in the interior of any dressing rooms.

(f) Light and Ventilation. Showers and dressing room areas must be furnished with one (1) watt of incandescent light for each square foot of floor area and have adequate ventilation.

(g) Soap Dispensers. Soap dispensers for providing either liquid or powdered soap must be provided at each lavatory or between each pair of lavatories. Soap dispensers providing either liquid or powdered soap must be provided at each shower head or between each pair of shower heads.

(h) Mirrors. Mirrors, if provided, must be shatter-resistant.

(i) Toilet Paper Holders. Toilet paper holders must be provided at each water closet.

(j) Tempered Water. Tempered water only must be provided at all shower heads. Water heater and thermostatic mixing valves must be inaccessible to bathers and must be capable of providing two (2) gallons per minute of water to each shower head. The temperature of the water must not exceed 90 degrees Fahrenheit and must have an automatic cut-off thermostat set at 90 degrees Fahrenheit.

(k) Towels. Single service paper towel dispensers or blower type hand dryers must be provided.

14. Minimum Toilet Facilities.

(a) Minimum toilet facilities shall be provided within a three hundred (300) foot walking distance of Type "B", "C", "D", "F" pools and Type "A" and "E" facilities that do not charge for admission. Minimum toilet facilities must consist of at least one (1) lavatory and one (1) water closet for each sex. Floors must be of impervious materials and relatively smooth, but not have a slick finish. Each room must be furnished with a minimum of 60 watts of incandescent light and have adequate ventilation. Soap dispensers for providing either liquid or powdered soap must be provided at each lavatory or between each pair of lavatories. Mirrors, if provided, must be made of shatter-resistant material. Single service paper towel dispensers or blower type hand dryers must be provided. Toilet paper holders must be provided at each water closet. Floors must be well drained to prevent standing water. Carpet shall not be used on the floors.

(b) Minimum toilet facilities are not required if all living units are within a three hundred (300) foot walking distance of the nearest water's edge and are each equipped with private facilities.

15. Filtration System.

(a) Diatomite Filters. Filters must be approved by and bear the seal of the National Sanitation Foundation. Filters may be of either pressure or vacuum type. The filter rate must not exceed two (2) gallons per minute per square foot of filter surface area. Provisions must be made for backwashing the filter at not less than two (2) gallons per minute per square foot of filter surface area. The filter(s) must be provided with pressure or vacuum gauges for determining the need for backwashing and sight glass to determine when backwash is clear.

(b) High Rate Sand Filters. Filters must be approved by and bear the seal of the National Sanitation Foundation (NSF). The filter rate may not exceed fifteen (15) gallons per minute per square foot of filter surface area. A higher rate may be allowed if approved by the NSF. Provisions must be made for backwashing the filter(s) at the manufacturer's recommended backwash rate. The filter(s) must be provided with pressure gauges for determining the need for backwashing, backwash sight glass, and air-relief device.

(c) Cartridge Filters. Filters must be approved by and bear the seal of the National Sanitation Foundation. The filters must be of a disposable or washable element. Surface types must have a maximum flow rate of 0.375 gallons per minute for each square foot of effective filter area. A spare cartridge filter must be provided at each site where these types of filters are used. A sump pit and or hard piped drain line must be installed to handle the design flow rate of the recirculation system. If connected to a sanitary sewer system or municipal separate storm sewer system, specific approval must be obtained from the municipality or sewer authority for such discharge.

(d) Other Filters. The National Sanitation Foundation and/or the Department must approve any filters other than those described above before they can be considered for use in the recirculation system for public swimming pools.

16. Filter Backwash. Backwash from the filter(s) must be piped to a disposal pit, tile field, or other disposal method approved by the Department. If the backwash water is to be discharged to a sanitary sewer system or municipal separate storm sewer system, specific approval must be obtained from the municipality or sewer authority for such discharge. If the method of backwash will be to an on-site storm sewer system, the location of the discharge and the name and distance of any receiving body of water must be identified on the project plans. Any discharge of backwash water to a water body must receive prior approval from the Department. All pools that directly discharge

backwash water to waters of the State or stocked ponds must be equipped with an appropriately sized dechlorination device. If the method of backwash disposal will be to a pit or tile field, the location of discharge must be identified on the project plans and the receptacle must be adequately sized to accept the pool drainage. Also, a three (3) minute backwash cycle must be conducted at the time of the final inspection to ensure that there is adequate capacity of the disposal system. A minimum six (6) inch air gap must be maintained at the discharge point or two (2) single in-line check valves must be installed in the backwash line. The receptacle must be sufficiently sized to accommodate the backwash flow.

17. Pool Drainage. The method and location of discharge employed to drain the pool must be included on the project plans and the receptacle must be adequately sized to accept the pool drainage. If the pool drains to a sanitary sewer system or municipal separate storm sewer system, specific approval must be obtained from the municipality or sewer authority for such discharge.

18. Rate of Flow Indicator. Every public swimming pool must be provided with a rate of flow indicator located on the discharge line from the filters. Rate of flow indicators must be accurate to + or - 5% and installed according to manufacturer's instructions. Dimensions must be shown on the schematic diagram, indicating the actual location of the rate of flow indicator. The rate of flow indicator must be calibrated for and provided with a scale reading in gallons per minute and shall have an upper range at least ten (10) percent above the maximum design flow rate. The scale resolution of the meter must fall within the design flow of the system. The activating element of the flow indicators must be installed in the filter effluent line. The flow meter must be mounted in a location such that it can be easily read.

19. Heater. Heaters, where used, shall be installed and operated in accordance with manufacturer's recommendations and local building codes to include proper ventilation. The heater design must be such that it will not affect the minimum required design flowrate. A thermostat control must be provided with an automatic cut-off for an upper limit of 104 degrees Fahrenheit and above. Solar panels may be used as a pool heater provided that the materials used in the solar panels must be non-toxic and acceptable for use with potable water. Data verifying the material is non-toxic must be submitted to the department for review and approval at the time the application is made. Pools equipped with solar panel heaters shall have a fixed thermometer mounted in the pool recirculation line downstream from the heater outlet. All equipment and appurtenance used to operate a solar panel heater must meet the applicable portions of R.61-51.

20. Pump and Motor. Pumps and motors under five (5) horsepower must be National Sanitation Foundation (NSF) approved or must be equally listed by a Testing Lab approved by the Department. The pump and motor must be of adequate size and capacity to provide the required pool turnover rate and should be located so as to eliminate the need for priming. If pump or suction piping is located above the overflow level of the pool, the pump must be self-priming. The pump and motor must be designed to supply, without overloading, the required design rate at a total dynamic head sufficient to overcome the friction losses in the piping, appurtenances, and the maximum headloss through the filter(s). Unless headloss calculations are provided by the designing engineer, pump design must be based on an assumed total dynamic head of fifty five (55) feet of water. All pumps must be provided with a corrosion-resistant strainer to remove solids, debris, hair, lint, etc. Pool pump motors must have a directly accessible on/off switch within three (3) feet horizontal distance of the pump(s). Pump(s) shall not be activated by a panel circuit breaker. All pumps shall be installed in accordance with the National Electrical Code (NEC). A device for regulating the rate of flow may be provided in the recirculation pump discharge piping.

21. Water Treatment. Equipment for halogen disinfection (chlorine, bromine) must be provided on all pools. This equipment must be approved by and bear the seal of the National Sanitation Foundation. The equipment must be of such capacity to feed one (1) pound of free available chlorine per ten-thousand (10,000) gallons of pool volume per twenty-four (24) hour period in all pools. The equipment must be operable at all times that the recirculation system is in operation. This equipment must be installed in accordance with the approved manufacturer's instructions. The equipment manufacturer's name and model number of chemical feeder, as well as the size and number of feeding tanks must be furnished. All chemical feed pumps must be wired directly to the recirculation pump such that when recirculation flow stops chemical feed is halted. GAS CHLORINATION IS NOT PERMITTED. No chemical may be manually fed while the pool is open for operation. Supplemental water treatment systems may be approved on a case by case basis.

Chemical feed containers for use with liquid feed systems, in excess of fifteen (15) gallons, must be provided with spill containment and must be clearly labeled. A detailed drawing must be included on the project plans. Ultraviolet (UV) or ozone disinfection may be added to any pool in addition to the minimum required disinfection.

22. Separate System. Each individual pool constructed must have its own pump, motor, filter, disinfection equipment, piping, etc., such that it is a complete unit and not dependent upon any other recirculation system, except as provided otherwise in these regulations. Separate recirculation systems are required for indoor-outdoor pools with a separate and independent system for both the indoor and outdoor bodies of water.

23. Automatic Controller. If an automatic controller is to be used, the device must be installed in accordance with the approved manufacturer's instructions. The chemical feed pump(s) must also be directly wired to the recirculation pump and a flow switch such that when the recirculation flow stops, the chemical feed pumps are switched off. Other alternatives that provide redundancy will be considered by the Department on a case-by-case basis.

24. Piping.

(a) The determination of sizes of pipe, fittings, and valves on the complete main pump suction line from the swimming pool must be based upon a rate of friction loss for piping of not more than six (6) feet per one-hundred (100) feet based upon the Hazen-Williams formula using the following "C" values:

- Iron Pipe: c = 100
- Copper Pipe: c = 120
- PVC Pipe: c = 150

(b) All piping on the discharge side of the pump for filtration and to the point for discharge of backwash water from the filter plant must have pipe sizes determined on a basis for friction losses which must not be more than twelve (12) feet per one-hundred (100) feet using "C" values given above.

(c) If PVC pipe is used it must be schedule 40 or greater, the chart below lists the maximum flow allowable in gallons per minute (gpm) for the indicated pipe sizes at 6'/100' suction loss and 12'/100' pressure loss for schedule 40 PVC plumbing.

Pipe Sizes in Inches	Suction at 6'/100' (flow in gpm)	Pressure at 12'/100' (flow in gpm)
1½"	27	39
2"	57	83
2½"	105	150
3"	165	245
4"	355	510
5"	640	925
6"	1000	1500

(d) All piping must be hydrostatically tested under pressure prior to being covered by earth, deck or pool structure. Minimum pressure for testing shall be thirty (30) psi or one and one half (1 1/2) times the normal operating pressure on the return line, whichever is greater. Pressure must be maintained constant for two (2) hours. PVC pipe must be approved by the American National Standards Institute/National Sanitation Foundation or other laboratory acceptable to the Department with the ANSI/NSF or equal designated seal on each section of pipe. Only SD 26 Class 160 and SD 21 Class 200 PVC pipe meeting ASTM Standard D1785 or D2241 are acceptable in sizes twelve (12) inches and smaller. No heat bending of PVC pipe is allowed. All pool piping, angles, and elbows must be braced and supported to preclude possible settlement or rupture of the line. Gravity waste lines around the pool six (6) inches or smaller must have a minimum slope of one-fourth (1/4) inch per foot toward the effluent point. Lines larger than six (6) inches and all out-fall waste lines must be designed with a size of pipe and slope to maintain a minimum velocity of two (2) feet per second with no overload or back pressure in the lines. All piping and equipment must be provided as much as possible with positive means of completely draining all water to prevent damage from freezing. All piping in the equipment room must be permanently

marked with directional arrows and identified as to origin and use, e.g., surface skimmer, main drains, etc. No flexible piping may be installed as part of the pool recirculation or booster systems. NSF PVC flexible piping may only be used for spa air lines and must be glued at all joints.

25. Pool Inlets and Outlets.

(a) All inlets and outlets must be provided and arranged to produce complete recirculation of water and the maintenance of uniform disinfectant throughout the pool. Relative placement of inlets and skimmers shall not produce short circuiting of the recirculation water. There must be at least four (4) return inlets, except for facilities covered under Section E and F. Wall return inlets must have variable orifice, directional flow fittings so that the flow pattern can be adjusted. Floor return inlets may be installed if they are uniformly spaced, if the number of floor return inlets provided meets the requirements of R.61-51.C.25(b). The maximum flow per inlet for all recirculation and booster system return inlets is twenty-five (25) gpm or a velocity of no greater than forty (40) feet per second per inlet. A minimum of ten (10) gpm must be provided per inlet. If necessary, the recirculation system shall be upgraded to meet the ten (10) gallon per minute requirement to ensure proper distribution of disinfectant.

(b) In pools with surface area greater than fifteen hundred (1,500) square feet, or length in excess of sixty (60) feet, inlets must be placed around the entire perimeter at maximum fifteen (15) foot intervals. In any case, an adequate number of inlets must be provided, properly spaced and located so as to accomplish complete recirculation and maintenance of a uniform and adequate level of disinfecting medium at all times. Approved inlets may be installed uniformly in the pool floor if the requirement of one (1) inlet per fifteen (15) feet of pool perimeter is met. All pool inlets must be corrosion resistant types and wall inlets must have means to adjust the flow pattern.

26. Overflow/Skimming Devices. All public swimming pools must have one (1) of the following types of surface skimming devices. Skimming action must be provided at all times when the recirculation system is in operation. Total capacity of all overflow/skimming devices in any pool must be at least one hundred percent (100%) of the required filter flow of the recirculation system.

(a) Perimeter Overflow Gutters. These gutters may be of the recessed or roll-out type. If recessed gutters are used, they must be located near the top of the pool wall and must have a minimum depth of three (3) inches. They must be uniformly level and be designed to serve as a handhold. The gutter drain outlets shall be constructed of non-corrosive material and must be placed on a maximum of fifteen (15) foot centers; gutter branch lines must be a minimum of two (2) inches in diameter. The gutter bottom must slope toward these outlets with a minimum slope of one-eighth (1/8) inch per foot. The gutter must be easily accessible for cleaning. The opening into the gutter must not be less than four (4) inches wide.

(i) When perimeter overflow gutters are used, a surge capacity must be provided to accommodate excess water that cannot be satisfactorily accommodated by the recirculation system. Surge capacity must be not less than one gallon for each square foot of pool surface. Recovery time required to return the overflow system to skimming action after maximum pool displacement has ceased must be minimized. Credit may be given for in pool surge capacity provided that the gutter is designed to serve in this manner and skimming action is provided over the complete range of water levels.

(ii) Roll-out gutters must have a width of eight (8) to twelve (12) inches and must have an edge that is uniformly level. The lip of the gutter must have a minimum pitch of one (1) inch to twelve (12) inches of width. Gutter drains of non-corrosive material must be located on maximum eight (8) foot centers; gutter branch lines must be a minimum of one and one-half (1 1/2) inches in diameter. The gutter must slope toward these outlets with a minimum slope of one-eighth (1/8) inch per foot.

(iii) Requests for gutters differing from those described above will be reviewed for approval on an individual basis after supporting engineering data, including complete hydraulics of the proposed gutter system and connecting piping has been submitted. Gutter systems must be designed so that skimming action will occur over the complete range of water levels from quiescence to full bather load.

(b) Recirculating Surface Skimmers. At least one (1) NSF listed skimmer must be provided for each four hundred (400) square feet of pool surface area, or major fraction thereof.

(i) Skimmers must be located so that the middle of the skimmer is positioned three (3) to seven (7) inches below the pool coping such that the normal operating water level of the pool is the middle of the skimmer. In lazy rivers, this depth may be increased to nine and one half (9.5) inches. The skimmer throat shall be made of tile and recessed a minimum of six (6) inches from the inside pool wall with a minimum of eighteen (18) inches opening in the pool wall angling into the skimmer throat opening (see diagram).

(ii) Skimmer weirs must be automatically adjustable to variations in water level over a range of at least three (3) inches.

(iii) An easily removable and cleanable basket, or screen, through which all overflow water must pass must be provided in each skimmer to trap large solids. One extra skimmer basket shall be provided for each pool.

(iv) The skimmer must be provided with an equalizer pipe to prevent airlock in the suction lines. This pipe must provide an adequate amount of make-up water for pump suction should the water of the pool drop below weir level. It must be at least one and one half (1 1/2) inches in diameter and be located at least one (1) foot below the lowest overflow level of the skimmer. It must be provided with a valve or equivalent device that will remain tightly closed during normal operating conditions, but will automatically open when the water level drops as much as two (2) inches below the lowest weir level.

(v) The overflow weir must operate at all flow variations expected, and must be of such buoyancy and design so as to develop an effective velocity over the weir lip.

(vi) The skimmer must be of substantial, enduring and corrosion-resistant material. Each skimmer must have a device to control flow.

(vii) Where concrete pavers are used for decking, the skimmers must be anchored in place with concrete to prevent them from settling.

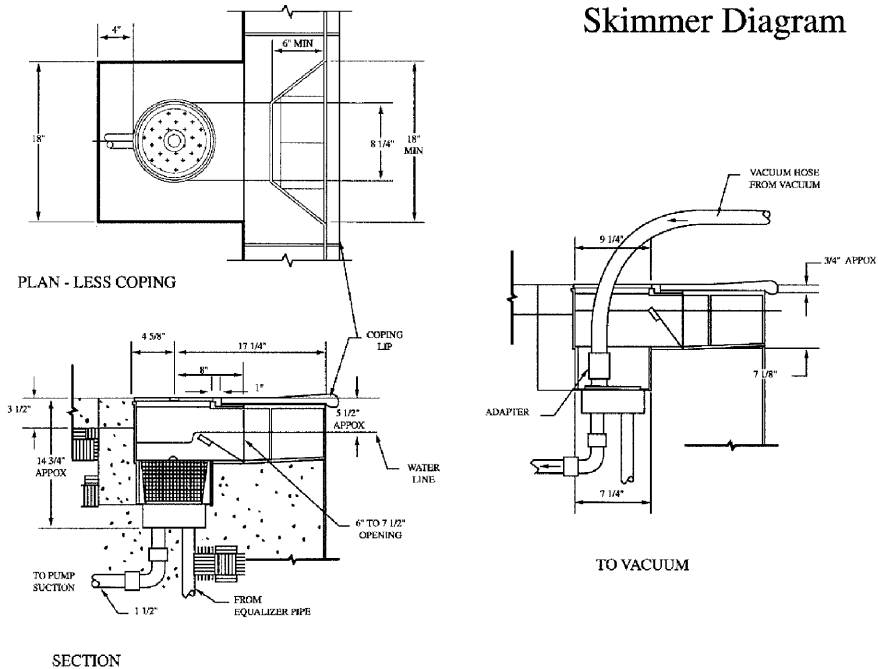

27. Safety Equipment.

(a) Lifeguard Chairs. There must be a minimum of one (1) lifeguard chair provided for each two-thousand (2,000) square feet of pool surface or major fraction thereof for Type "A" and "E" pools. Where two (2) or more lifeguard chairs are required they shall be strategically located to provide adequate coverage for all bathers. Lifeguard chairs must be elevated to such a height that will allow complete survey of the pool swimming area.

(b) Life Saving Equipment. All pools must be equipped with at least one (1) unit of life saving equipment must be inside the fence and be within two hundred (200) feet walking distance from any point on the pool perimeter. This equipment must be located within the pool area and inside the fence. One (1) unit of life saving equipment must be provided for each lifeguard chair. Life saving equipment is not required at Type "C" and "D" pools. All life saving equipment must be visible from the deck and unimpeded access must be provided.

(c) Emergency Equipment. All Type "A" and "E" pools must be equipped with at least one (1) unit of emergency equipment.

(d) First Aid Kit. All Type "A" and "E" pools must have a first aid kit. This kit must be readily accessible when the pool is open to the public.

28. Signs.

(a) All signs must be clearly displayed around the pool and must be free of obstructions including vegetation.

(b) Pool Rules Sign. At least one (1) "Pool Rules" sign for informational purposes must be posted such that the sign is visible from all entrance points of the pool and must contain, as a minimum, the items listed below, with the blanks reflected in (xii) through (xvi) below filled in before authorized operation:

- (i) There should be no solo swimming.
- (ii) There should be no running, boisterous or rough play.
- (iii) No person under the influence of alcohol or drugs should use the pool.
- (iv) There should be no spitting or blowing nose in pool.
- (v) Persons with diarrheal illness or nausea should not enter the pool.
- (vi) Persons with skin, eye, ear or respiratory infections should not enter the pool.
- (vii) Persons with open lesions or wounds should not enter the pool.
- (viii) No animals or pets allowed in the pool.
- (ix) No glass allowed in the pool or on the deck.
- (x) No children should be in the pool without supervision.
- (xi) You should take a shower before entering the pool.
- (xii) This pool is open from a.m. to p.m.
- (xiii) The maximum number of swimmers allowed in the pool is ____.
- (xiv) A first aid kit is located ____.
- (xv) An emergency phone (or other notification device) is located ____.
- (xvi) Life saving equipment is located at ____.

(c) No Diving Sign. In addition to the above sign, permanent and separate "NO DIVING ALLOWED" signs must be displayed in conspicuous locations at all pools of surface area greater than two hundred (200) square feet and not having dimensions adequate for diving. The sign must read in all capitalized letters "SHALLOW WATER - NO DIVING ALLOWED" and must have minimum four (4) inch lettering for "SHALLOW WATER" and six (6) inch lettering for "NO DIVING ALLOWED". Two (2) or more signs must be provided so as to be clearly visible to anyone entering the pool. This sign may be required on Type "C", "D", "E", "F", and "G" pools if the Department decides the signs are applicable.

(d) No Lifeguard on Duty Sign. In addition to the above signs, permanent and separate "NO LIFEGUARD ON DUTY" signs must be displayed in conspicuous locations. The sign must read in all capitalized letters "NO LIFEGUARD ON DUTY - SWIM AT YOUR OWN RISK" and must have minimum six (6) inch lettering for "NO LIFEGUARD ON DUTY" and must have minimum four (4) inch lettering for "SWIM AT YOUR OWN RISK". Two (2) or more signs must be provided and be clearly visible to anyone entering the pool. These signs are required on all Type "B", "C", "D", "F", and "G" pools that do not have lifeguards.

(e) Spa Caution Sign. In addition to a pool rules sign, heated spas must also have a waterproof sign with bold lettering which is clearly visible and contains the following warning statement:
CAUTION

CAUTION

(i) Elderly persons and those suffering from heart disease, diabetes, high or low blood pressure should consult their physician before using the spa.

(ii) The use of this spa while under the influence of alcohol, anticoagulants, antihistamines, vasoconstrictors, vasodilators, stimulants, hypnotics, narcotics or tranquilizers should be avoided.

(iii) Pregnant women should not use the spa without consulting their physician.

(iv) Persons should spend no more than fifteen (15) minutes in the spa at any one (1) session. Long exposures may result in nausea, dizziness or fainting.

(v) The maximum temperature recommended by the South Carolina Department of Health and Environmental Control, for any spa is 104°F. The actual temperature of this spa at ___ o'clock today is ___°F.

(f) Pool Operator Sign. A sign must be posted or language must be added to the "Pool Rules" sign which reads, "The Pool Operator at this facility is _____ State license number _____."

29. Main Drains.

(a) A minimum of two (2) main drains must be provided on the bottom floor of the pool with at least one (1) at the lowest point of the floor to completely drain the entire pool. All such outlets must be interconnected and each drain must be directly connected to the main drain line. The interconnecting line must be adequately sized to accommodate one hundred (100) percent of the recirculation or booster pump flow. The main drain spacing must not be greater than twenty (20) feet nor less than three (3) feet on centers, nor shall they be more than fifteen (15) feet from any side wall. Interconnecting and outlet pipes must be flush with side wall and/or floor of main drain sump. If the pool is intended for fire protection the main drains and piping associated must be sized appropriately and shown on the plans.

(b) Each outlet grate area must be sized to accommodate 100% of the recirculation flow and the velocity through the open area of the grate must not be greater than one and one-half (1 1/2) feet per second. Each drain sump or pot must be of adequate depth and design to provide for uniform suction across the entire grate area. Outlet grates must be anchored with corrosion resistant screws that cannot be removed without the use of tools and slots must not be more than one-half (1/2) inch wide. When the outlet fittings are of the anti-vortex type, maximum entrance velocities may be increased to six (6) feet per second. All outlet grates must be of corrosion resistant materials.

(c) Hydrostatic relief valves must be incorporated into at least one of the lowest main drain sumps or a well point system must be provided. These may not be required when the bottom of the pool is above the high water table.

30. Overflow. Overflows are required for all indoor pools having a volume of fifteen hundred (1,500) gallons or greater. If overflow connections are not provided in skimmers or surge tanks, some type of overflow must be built into the pool wall which will be of sufficient size to carry off water that could be supplied by the fill spout, rainfall, or automatic fill device. All such overflow devices must drain to an approved location and must have a minimum six (6) inch air gap or check valve. Overflows must discharge to a location that drains away from the pool area such that the discharge remains visible when overflowing.

31. Electrical and Illumination Requirements. Artificial lighting must be provided at all public swimming pools which are to be used at night or which do not have adequate natural lighting so that all portions of the pool, including the bottom, may be readily seen without glare.

(a) Underwater Lighting. Where underwater lighting is used, not less than 0.5 watts of incandescent lighting or 8.35 lumens must be provided per square foot of pool area. An adequate number of lights must be used and properly positioned so that all portions of the pool are clearly visible to an observer on the pool deck. Fiberoptic lighting may only be installed as a supplement to the minimum lighting requirements outlined above. Colored lights that do not provide for an equivalent light output to the wattage or lumens noted above for clear lights cannot be used.

(b) Area Lighting. Where underwater lighting is used, uniform area lighting must be provided for the deck area and directed toward the deck area and away from the pool surface insofar as practical. Illumination of the pool deck surface must be at least ten (10) foot candles of intensity, or not less than 0.6 watts of incandescent light or 10 lumens per square foot. Where underwater lighting is not used and night swimming is permitted, uniform area lighting must be provided in an amount of not less than thirty-two (32) foot candles of intensity, or not less than two (2) watts of incandescent light or 33.5 lumens per square foot of pool area in addition to 0.6 watts of incandescent light or ten (10) foot candles of intensity per square foot of deck area. These lights must be placed around the pool area such that all sections and depths of the pool are clearly visible at all times. Light fixtures located within the pool area must be protected by a non-breakable lens.

(c) Overhead Conductors, Wiring and Lights.

(i) Overhead conductors and wiring not in conduit must not pass within an area extending a distance of twenty (20) feet horizontally away from the inside edge of the pool walls, diving structures, observation stands, towers, or platforms. No pool can be constructed under an existing utility owned supply conductor in accordance with the current edition of the National Electrical Safety Code.

(ii) There shall be no light fixtures or conductor splices directly above the water surface at any outdoor pool. Indoor pools must comply with the same restriction except that light fixtures protected by a non-breakable lens are allowed.

(d) Wiring and grounding for lights and all electrical power for swimming pool equipment must conform to the codes of the current edition of the National Fire Protection Association (NFPA) National Electric Code. All electrical circuits within the pool area including all accessory equipment, electric drinking water fountains, and bathhouse/minimum toilet facility receptacles are required to meet the current edition of the NFPA National Electric Code; provided, however, all such circuits shall have ground fault protection regardless of their proximity to the pool. Exceptions may be granted for lighting and fixtures that are twenty-five (25) feet or more above the pool deck and would not pose a risk of electrocution. Junction boxes must be above the pool water level and must not be a trip hazard.

32. Instructions For Operation.

(a) The specifications and/or plans for all public swimming pools must include the provision that upon completion of any swimming pool, the builder must give the owner and his operators complete written and oral instructions in the operation of the pool and all equipment, in the chemistry of swimming pool water and specific details covering the maintenance of the equipment. Also, these instructions and provisions must consist of the operation of the entire facility under the builder's observation for a minimum of three (3) days. All valves must be permanently tagged and identified as to use and a valve operating schedule must be provided for every operation.

(b) Instructions, including the valve schedule, must be supplied in not less than two (2) copies. These must be encased in a water proof covering with one (1) copy permanently posted on the equipment room wall.

33. Equipment Acceptance. Any equipment to be used in public swimming pools must be approved by the National Sanitation Foundation Testing Laboratory, Inc., Ann Arbor, Michigan, or other laboratories acceptable to the Department, where applicable.

34. Swimming and Deck Limits.

(a) The total number of persons which can safely utilize a swimming pool facility shall be based upon the sum of the following areas:

(i) Swimming Area. (The area between the transition point and the diving area) One (1) person for each twenty-five (25) square feet of surface area.

(ii) Shallow Area. One (1) person for each ten (10) square feet of surface area.

(iii) Deck Area. One (1) person for each thirty-three (33) square feet of the required minimum deck area.

(iv) Type "D" Pools. One (1) person for each ten (10) square feet of surface area.

(b) The pool capacity determination is not applicable for Type "C" and "E" pools.

(c) Diving Area. An area extending a ten (10) foot radius from the extremity of a diving board or tower will be considered as reserved for divers, and not more than one (1) person shall be permitted in the water in this area at any time diving is in progress. Only one (1) person is allowed on any diving board at one time.

35. Steps and Ladders. At least one (1) ladder/steps must be provided for each seventy-five (75) feet of pool perimeter. Two (2) or more ladders/steps must be provided for all Type "A" and "B" pools.

(a) Ladders - All ladders must have a minimum of three (3) tread design and must include treads of non-slip construction. All ladders must be commercially-rated and designed so as to be secured tightly in place when the pool is in operation unless they are removed for certain aquatic events. Grab rail recess step type ladders can be used in lieu of the standard three (3) tread ladder.

(b) Steps - Steps shall have a minimum tread width of twelve (12) inches, a maximum rise of eleven (11) inches and a minimum length of thirty (30) inches. All step risers must be of uniform height (within one half (1/2) inch of each other) with the exception of the bottom riser. All step treads must be level with a tolerance for step slope of one half (1/2) inch. When radial steps are to be constructed, the minimum standards are shown in Figures 1, 2 and 3 as follows. All steps shall be non-slip and constructed in the shallow end of the pool only. Permanent black or dark colored edge stripes such as tile must mark steps. The edge stripe must be a minimum of two (2) inches wide, must be provided the entire length of each step, must be non-slip in texture, and must be installed on the run of each step so as to be clearly visible by patrons upon entering the pool. The step edge stripe must start within one (1) inch from the edge of the step.

RADIAL POOL STEPS

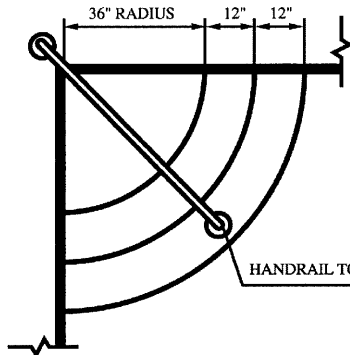

Figure - 1

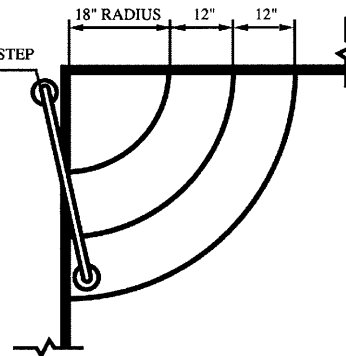

Figure - 2

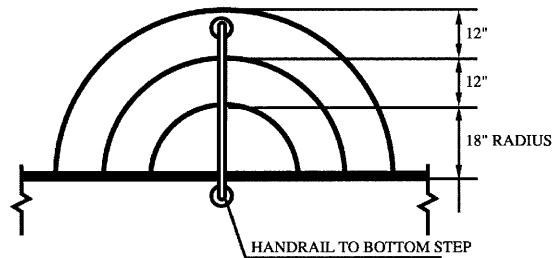

Figure - 3

(c) Handrails - Where steps are used, a minimum of one (1) handrail must be installed. All handrails must be securely anchored, extend over and anchor into the bottom step, and be easily accessible for exiting the pool. No portion of the handrail shall be closer than three (3) feet from any other handrail, unless Americans with Disabilities Act (ADA) requirements apply. No figure four type handrails may be installed except on fiberglass pools and Type "C" pools. Where the average step length, as measured from the front edge of the middle step, is over ten (10) feet in width there shall be one (1) additional handrail for every average ten (10) feet of step width or major fraction thereof and they shall be evenly spaced. Handrails must be of the removable type. Handrails shall be designed so as to be secured tightly in place when the pool is in operation unless they are removed for certain aquatic events.

(d) Tanning Ledges - When tanning ledges are provided, the maximum water depth shall be twelve (12) inches. If the distance from the tanning ledge to the coping exceeds eleven (11) inches, then a single step and handrail must be provided.

36. Construction Variance. When a pool contractor desires to use a construction procedure inconsistent with the regulations or use materials and/or equipment other than specified in these regulations a variance may be requested from the Department. Such a request must be submitted in writing and shall include a description of the material(s), equipment, and/or construction procedure(s) proposed, identify the material, equipment and/or procedure required by the regulation, and include proof of equivalency. This request for a variance will be considered by the Department for approval. The Department's decision on such a variance will be final.

37. Bridges. Bridges over the pool shall be built so that they will not introduce any contamination to the pool water. The minimum height of the bridge shall be at least seven (7) feet from the bottom of the pool and at least four (4) feet above the surface of the pool. Minimum forty-two (42) inch high handrails shall be provided along each side of the bridge. The walking surfaces shall be constructed of concrete or nonabsorbent material having a non-slip finish. A sign must be posted at both ends of any bridge crossing over a pool stating in all capitalized letters "NO DIVING OR JUMPING FROM BRIDGE ALLOWED". This sign must be clearly visible to anyone walking over the bridge.

38. Portable Kiddie Slides. Portable slides must comply with the requirements of Section G Paragraph 1, Section G Paragraph 2, Section G Paragraph 3(a), 3(b), 3(d)(vi), 3(d)(vii), 3(e)(ii), and 3(e)(iii). Portable slides are only allowed in Type "A" and "E" pools.

(a) The distance between the slide exit and the opposite side of the landing pool or other obstructions shall be a minimum of fifteen (15) feet.

(b) The slide must terminate no more than two (2) inches above the water surface and cannot terminate on an angle.

(c) Potable water supplies for wet slides shall be protected by proper backflow prevention and any piping or hose shall not be a trip hazard.

(d) Portable slides must be secured when not in use or when an attendant is not available.

(e) Where applicable or recommended by the manufacturer, it may be necessary to secure the slide to the deck with anchor bolts or other suitable mounting hardware.

39. Surge tank. Where surge tanks are provided, a means to clean and maintain the tank shall be shown on the plans. Main drains must be located in the bottom of the tank.

D. PUBLIC SWIMMING POOL DESIGN REQUIREMENTS FOR TYPE "A" AND "B", AND "G" POOLS

1. Applicability. Requirements of this section are applicable to all new construction and alterations of existing public swimming pools.

2. Pool Depths.

(a) The depth in the shallow portion must begin at three (3) feet and slope continually toward the deepest point of the pool.

(i) Where a pool is constructed with a maximum depth of five (5) feet, six (6) inches or less, the bottom must slope continually at a maximum of one (1) foot vertical to ten (10) feet horizontal and no lifeline is required.

(ii) Where the maximum pool depth exceeds five (5) feet, six (6) inches there shall be a lifeline between the shallow and the deep end which must be located at a point across the pool one (1) to two (2) feet on the shallow side of the transition point. Where there is no transition point, the lifeline must be at the four (4) foot, six (6) inch depth. The pool must slope continually from shallow end to the slope transition point; and the slope must not exceed one (1) foot vertical to ten (10) feet horizontal.

(b) Lifelines. The lifeline must be made of polyethylene or nylon rope with floats made of soft plastic or cork placed at not more than five (5) foot intervals. The lifeline must be minimum three-fourth (3/4) inches diameter and have floats at least five (5) inches by six (6) inches in size.

(c) Transition Point. Where the maximum pool depth exceeds five (5) feet, six (6) inches a permanent non-slip black or dark color tile stripe must be incorporated in the floor and the walls of the pool to mark the slope transition point. This tile stripe must be a minimum four (4) inches and a maximum six (6) inches wide and located at a point across the pool one (1) to two (2) feet on the shallow side of the transition point. Where there is no change in slope this line must be placed at the four (4) foot, six (6) inch depth.

(d) Zero-Depth Entry Pools. Zero-Depth entry pools are allowed in Type "A" and "B" pools only when a lifeline is placed at the two (2) to three (3) foot depth and a breakline tile stripe meeting the requirements of Section D Paragraph 2(c) is collocated with the lifeline.

(i) In addition to the required number of surface skimmers or perimeter gutter system, Zero-Depth entry pools must have either a gutter/trench with a grate cover installed along the zero depth area at an elevation which allows effective skimming at the trench at all times or two additional skimmers. Each of these additional skimmers must be located on each side of the zero depth entry at a water depth of between six (6) and twelve (12) inches. If the zero depth entry is greater than forty (40) feet in length, a gutter with a grate is required. All gutter designs will require either a collection/surge tank or a trough with a depth of at least twelve (12) inches. All installations that require a gutter must install an auto-fill device.

(e) Diving Boards. At least thirteen (13) feet of unobstructed vertical distance must be maintained above any diving board. This thirteen (13) foot height must extend eight (8) feet to each side and twenty (20) feet ahead of the front end of the board. In case of multiple diving boards, the above vertical distance must be provided for each board. Where diving is permitted, minimum depths of pools and clearances for various pool elements must be as shown in the following diagrams and tables (following Section D(2)(j)). Pool widths must be a minimum of eighteen (18) feet throughout the diving section.

(f) Depths and Clearances. The depths and clearances shown in the chart must be used as the basis for determining the safety features of pools which are not rectangular in shape. Cross-sectional diagrams must be given so that minimum depths and clearances may be determined for pools of non-rectangular shape; a minimum of one (1) longitudinal and one (1) latitudinal cross-sectional diagram must be given for all pools. Where a pool is built to permit diving, but has no diving board installed, diving is permitted only at the point on the deep end where a board would be installed. This point must be marked on the pool coping with the lettering "Diving permitted from this point only." The lettering shall be a minimum of 4" high and shall be marked on the deck or coping at a maximum of 12" from the pool edge.

(g) Walls, Ledges, and Islands. All walls must be vertical. No ledges are permitted inside the main pool body. Islands and walkways are allowed inside the main pool body provided that they are above the normal water level and extend to the bottom of the pool floor.

(h) Seats. Seats may be allowed in the shallow portion of the pool in water depths of four (4) feet or less if completely recessed from the main body of the pool. Recessed shall mean thirty six (36) inches back from the main pool body and not contiguous to any steps. The seat shall be eighteen (18) inches wide and eighteen (18) inches shall be for leg room. The maximum water depth over the seat shall not exceed twenty (20) inches. The front edge of the seat must be marked with a black or dark colored, non-slip tile a minimum of two (2) inches wide. A non-slip tile reading "NO STEP" shall be placed on the seat (1 1/2 inch lettering) and correspondingly on the deck (1 1/2 inch lettering) with no more than five (5) feet between signs if the seat is wider than ten (10) feet, otherwise the "NO STEP" sign shall be placed in the middle of the bench.

(i) The depths of the shallow portion of a pool with racing lanes which are intended to be used for lap swimming may be increased to three and one-half (3 1/2) feet or four (4) feet. The racing lanes must be marked in black tile or dark colored tile. This tile shall be non-slip. The tile lanes must be a minimum of six (6) inches wide and a maximum of twelve (12) inches wide.

(j) Construction tolerances shall be within plus or minus (+ or -) three (3) inches of design for overall pool length, width, or depth.

Pool Specifications

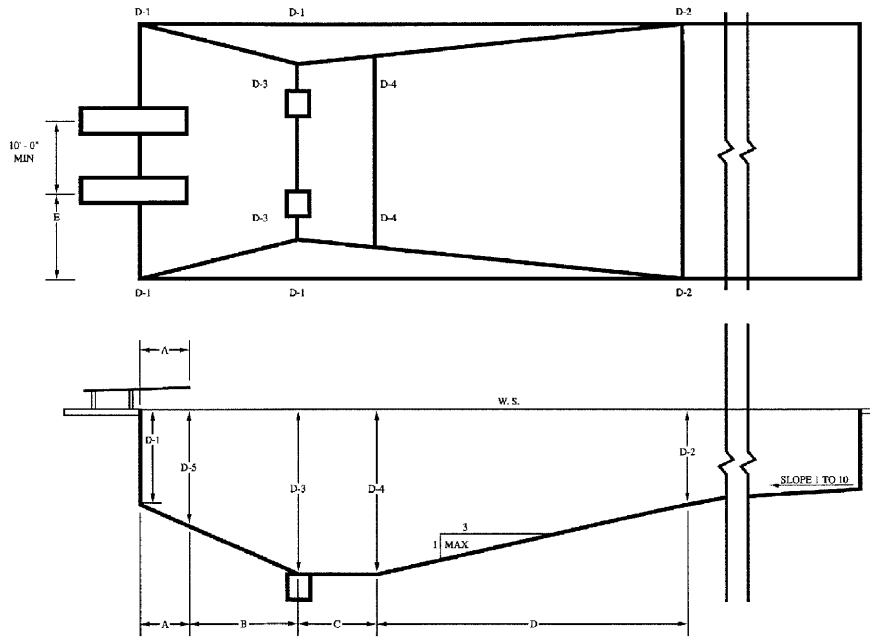

DEPTH — MINIMUM

Stands & Boards Maximum Height to Water	D-1	D-2	D-3	D-4	D-5
3-Meter Board	6'-0"	4'-6"	12'-6"	12'-0"	12'-0"
1-Meter Board	6'-0"	4'-6"	10'-6"	10'-0"	10'-0"
Deck Level Board (Less than 26")	6'-0"	4'-6"	9'-0"	8'-6"	8'-6"
No Board	6'-0"	4'-6"	8'-6"	8'-0"	8'-0"
No Diving Pool	3'-0"	3'-0"	3'-0"	3'-0"	3'-0"

LENGTH OF SECTION — MINIMUM

Stands & Boards Maximum Height to Water	A	B	C	D	E
3-Meter Board	5'-0"	6'-0"	9'-0"	23'-0"	13'-0"
1-Meter Board	5'-0"	6'-0"	9'-0"	17'-0"	11'-0"
Deck Level Board (Less than 26")	2'-6"	6'-0"	7'-6"	12'-0"	9'-0"
No Board	-	6'-0"	6'-0"	12'-0"	-
No Diving Pool	-	-	-	-	-

D-1 shall be no farther out than a maximum of 15" from pool wall. Slope of D shall not exceed 1'-0" vertical to 3'-0" horizontal. The maximum values of A are 6'-0" for 1-Meter and 3-Meter boards and 4'-0" for deck level boards. Clearance above the board must extend the entire length of sections B, C and D. Depth D-5 is measured at midpoint of Section B where a diving board is not provided. Where a diving board is provided D-5 shall be measured from the tip of the board. The minimum distance between the diving well wall on the deep end and any opposite wall shall not be less than six (6) feet greater than the diving bowl dimensions (B, C and D). All diving boards that are placed at a height above water between those listed shall be made to comply with

the listing that is greatest, e.g. 34" board shall comply with the one meter board height above water. Shallower water depths of 3 1/2 feet or 4 feet will be considered for pools with racing lanes that will be used for competitive swimming and diving from stands.

(k) Vanishing edge pools. Any vanishing edge pool that has a drop of eighteen (18) inches or less as measured from the top of the edge to the normal operating level in the receiving trough is not required to have safety netting. If the drop exceeds eighteen (18) inches, the Department may require the installation of safety measures (safety netting, grates, etc.) to prevent injury. Troughs must be designed to deter access and must have appropriate signs (i.e. "Keep Out", "Do Not Enter", etc.) troughs must be provided with appropriately sized main drains and designed to provide skimming action.

DEPTH minimum feet (') and inches (")					
Stands and Boards Max to water	D-1	D-2	D-3	D-4	D-5
Three (3) Meter Board	6' 0"	4'6"	12'6"	12'0"	12'0"
One (1) Meter Board	6'0"	4'6"	10'6"	10'0"	10'0"
Deck Level Board [Less than twenty six (26) inches]	6'0"	4'6"	9'0"	8'6"	8'6"
No Board	6'0"	4'6"	8'6"	8'0"	8'0"
No Diving Pool	3'0"	3'0"	3'0"	3'0"	3'0"
LENGTH OF SECTION minimum					
Stands and Boards Max to water	A	B	C	D	E
Three (3) Meter Board	5'0"	6'0"	9'0"	23'0"	13'0"
One (1) Meter Board	5'0"	6'0"	9'0"	17'0"	11'0"
Deck Level Board [Less than twenty six (26) inches]	2'6"	6'0"	7'6"	12'0"	9'0"
No Board	6'0"	6'0"	12'0"	-	-
No Diving Pool	-	-	-	-	-

D-1 shall be no farther out than a maximum of 15" from pool wall. Slope of D shall not exceed 1'-0" vertical to 3'-0" horizontal. The maximum values of A are 6'-0" for 1-Meter and 3-Meter boards and 4'-0" for deck level boards. Clearance above the board must extend the entire length of sections B, C and D. Depth D-5 is measured at midpoint of Section B where a diving board is not provided. Where a diving board is provided D-5 shall be measured from the tip of the board. The minimum distance between the diving well wall on the deep end and any opposite wall shall not be less than six (6) feet greater than the diving bowl dimensions (B, C and D). All diving boards that are placed at a height above water between those listed shall be made to comply with the listing that is greatest, e.g. 34" board shall comply with the one meter board height above water. Shallower water depths of three and one-half (3 1/2) feet or four (4) feet will be considered for pools with racing lanes that will be used for competitive swimming and diving from stands.

3. Diving Towers, Stands, and Sliding Boards. Diving towers in excess of three (3) meters in height are not to be considered as acceptable in a public swimming pool without special provisions, controls and limitations on their use. No sliding boards are allowed in any Type "B" pool. All diving stands (starting blocks) installed at pools with racing lanes must be of the removable type.

4. Recirculation System.

(a) A recirculation system consisting of pumps, motors, piping, filters, inlets, outlets, disinfecting and other water conditioning equipment and necessary accessories must be provided for water purification in accordance with water quality criteria contained herein and must be designed to completely turnover the entire pool volume per the following schedule:

(i) Type "A" six (6) hours

(ii) Type "B" six (6) hours; except Type "B" lazy rivers under sixty-thousand (60,000) gallons which shall have a turnover time of four (4) hours

(b) The recirculation system shall be designed to operate on a twenty-four (24) hour basis. The normal pattern of recirculation developed must be fifty (50) percent flow through the overflow or skimming facilities and fifty (50) percent through the main drains. The recirculation system must be designed with adequate capacity such that one hundred (100) percent of the recirculation flow can pass through the overflow or skimming facilities and one hundred (100) percent through the main drains.

5. Vacuum Lines. No vacuum outlets less than six (6) inches or more than eighteen (18) inches below the normal operating water level will be allowed. The measurement will be from the center of the vacuum outlet fitting to the water surface. If skimmer vacuum attachment is used, this requirement does not apply.

6. Pool Deck. The pool deck must be constructed in accordance with Section C, Paragraph 6.

7. Pool Width. Type "A", "B", and "G" pools must be a minimum of ten (10) feet wide, with the exceptions of alcoves and lazy rivers. Lazy rivers must be a minimum of six (6) feet wide. Alcoves are recessed areas of the pool where seats may be located.

8. Type "G" Pools. Each zone of a type "G" pool must maintain the required turnover rate for its intended usage type (e.g. a type "C" pool has a 1 hour turnover rate, therefore a kiddie pool zone would require a 1 hour turnover rate). To ensure that this requirement is met, a separate return line must be provided for each zone. Each return line must be provided with a flow meter that meets the requirements of R.61-51.C(18), or other Department-approved method to ensure the required flow rate per zone is maintained.

E. DESIGN REQUIREMENTS FOR TYPE "C" POOLS

1. Applicability. Requirements of this section are applicable to all new construction and alterations of existing public swimming pools.

2. Type "C" Pools. In addition to meeting all other applicable requirements of these regulations as found in Section C, Type "C" pools must also meet the following:

(a) There must be a minimum of two (2) inlets and two (2) main drains and at least one (1) surface skimmer positioned and operated in accordance with R.61-51.C.26(b).

(b) When only one (1) skimmer is provided and the equalizer outlet is installed on the pool floor, it must be equipped with a minimum of two (2) interconnected suction fittings spaced at least twelve (12) inches apart. The interconnecting line must be sized to accommodate one hundred (100) percent of the recirculation flow.

(c) Main drains shall be located on the pool bottom floor.

(d) Inlets and outlets must be provided and arranged to produce complete recirculation of pool water and the maintenance of a uniform and adequate level of disinfecting medium at all times.

(e) A means of completely draining the contents of the pool to waste must be provided without passing through the filter. This may be done by a gravity waste line directly from the pool or by pumping and by-passing the filter.

(f) The maximum depth for a wading pool shall be eighteen (18) inches at the center. The bottom must have a maximum slope of no greater than five-eighths (5/8) inches per foot toward waste outlets or main drains. The depth at the perimeter may be zero (0) feet.

3. Spray Pools. In a spray pool, water must be designed to drain away freely as it sprays over the area. Water quality, wall and floor construction must meet the same requirements as set forth for public swimming pools. The bottom must have a minimum slope of not less than one-fourth (1/4) inch per foot (nor maximum of more than five-eighths (5/8) inch per foot) toward waste outlets. All equipment drains, steps, gadgets, and toys must be installed per the manufacturer's recommendations.

4. Recirculation System. A recirculation system consisting of pumps, motors, piping, filters, inlets, outlets, disinfecting and other water conditioning equipment and necessary accessories must be provided for water purification in accordance with water quality criteria contained herein and must be designed to completely turnover the entire pool volume in one (1) hour. The recirculation system shall be designed to operate on a twenty-four (24) hour basis. The normal pattern of recirculation developed must be fifty (50) percent flow through the overflow or skimming facilities and fifty (50) percent through the main drains. The recirculation system must be designed with

adequate capacity such that one hundred (100) percent of the recirculation flow can pass through the overflow or skimming facilities and one hundred (100) percent through the main drain.

5. Pool Deck. The pool deck must be constructed in accordance with Section C, Paragraph 6.

6. Sliding Boards. No sliding boards are allowed in any Type "C" pool.

7. Steps. If installed, one set of steps designed in accordance with Section C, Paragraph 35 shall be provided.

8. Fill Line. Kiddie pools may be filled by a hose bibb protected by an ASSE 1024 listed residential dual check or other Department approved backflow prevention device.

9. Automatic Controllers. All new Type "C" pools must be equipped with automatic controls to provide adequate feed rate of halogen and pH adjustment chemicals in order to keep the disinfectant and pH at the required levels on a continuous demand basis. A warning light or indicator shall be provided in a visible location for supervisory control. The device shall indicate absence of chemicals in feeders, improper adjustment of chemical dosage, or any other mechanical or operational malfunctions, e.g. recirculation flow stops.

F. DESIGN OF TYPE "D" POOLS

1. Applicability. Requirements of this section are applicable to all new construction and alterations of existing public swimming pools.

2. Type "D" Pools. In addition to meeting all other applicable requirements of these regulations as found in Section C, including steps and handrails, except where fiberglass spas are used, figure four handrails may be acceptable provided they extend over the last step. Type "D" pools must also meet the following:

(a) There must be a minimum of two (2) inlets, two (2) main drains to be located on the pool bottom floor and at least one (1) surface skimmer or gutter system positioned and operated in accordance with R.6-51.C.26.

(b) All drains providing water to the booster system must be located on the pool bottom floor.

(c) Inlets and outlets must be provided and arranged to produce complete recirculation of pool water and the maintenance of a uniform and adequate level of disinfecting medium at all times.

(d) The maximum depths for Type "D" pools shall be four (4) feet. Type "D" pools must be provided with a means of completely draining the contents of the pool to waste without passing through the filter. This may be done by a gravity waste line directly from the pool or by pumping and by-passing the filter.

(e) All Type "D" pools must have a single timer set for a maximum of 15 minutes which must turn on and off the hydro pump and blower if provided. This timer switch must be inaccessible to persons while in the spa.

(f) An emergency cut-off switch must be provided in the pool area which, when triggered, will simultaneously shut off the spa booster and recirculation pumps. This switch must be clearly visible, labeled, easily accessible at all times, and no greater than a twenty five (25) foot distance from the entrance steps of the spa.

(g) The top front edge of seats must be marked with a black or dark colored stripe in accordance with R.61-51.D.2(h).

(h) No sliding boards are allowed in Type "D" pools.

3. Recirculation System.

(a) A recirculation system consisting of pumps, motors, piping, filters, inlets, outlets, disinfecting and other water conditioning equipment and necessary accessories must be provided for water purification in accordance with water quality criteria contained herein and must be designed to completely turnover the entire pool volume per the following schedule based upon pool volume:

(i) Up to one thousand and five hundred (1,500) gallons: one-half (1/2) hour.

(ii) One thousand and five hundred (1,500) gallons up to four thousand (4,000) gallons: one (1) hour.

(iii) Four thousand (4,000) gallons up to eight thousand (8,000) gallons: two (2) hours.

(iv) Eight thousand (8,000) gallons up to sixteen thousand (16,000) gallons: four (4) hours.

(v) Over sixteen thousand (16,000) gallons: six (6) hours.

(b) The recirculation system shall be designed to operate on a twenty-four (24) hour basis. The normal pattern of recirculation developed must be fifty (50) percent flow through the overflow or skimming facilities and fifty (50) percent through the main drains. The recirculation system must be designed with adequate capacity such that one hundred (100) percent of the recirculation flow can pass through the overflow or skimming facilities and one hundred (100) percent through the main drain.

4. Pool Deck. The pool deck must be constructed in accordance with Section C, Paragraph 6.

5. Pool Temperatures. For heated pools a thermostat control must be provided with an automatic cut-off for an upper limit of 104 degrees Fahrenheit and above.

6. Automatic Controllers. All new Type "D" pools shall be equipped with automatic controls to provide adequate feed rate of halogen and pH adjustment chemicals in order to keep the disinfectant and pH at the required levels on a continuous demand basis. A warning light or indicator shall be provided in a visible location for supervisory control. The device shall indicate absence of chemicals in feeders, improper adjustment of chemical dosage, or any other mechanical or operational malfunctions, e.g. recirculation flow stops.

G. DESIGN OF TYPE "E" POOLS

1. Applicability. Requirements of this section are applicable to all new construction and alterations of existing public swimming pools.

2. Type "E" Pools. In addition to all other applicable requirements of these regulations found in Section C, Type "E" pools must also have a recirculation system for filtering and disinfecting the water used, except as may be justified to and found acceptable by the Department.

3. Waterslides and Flumes.

(a) The slopes and radii of each flume and flume section must be acceptable to the Department. Each flume must be properly banked when used in any curved section; regardless of degree of curvature. Each flume must be designed to enter the landing pool in a safe manner. The landing pool must be of dimensions suitable to prevent accidental collision between users and/or walls. It may be necessary to obtain a certified inspection permit from the South Carolina Department of Labor if the law so provides for same.

(b) All sections of a flume must be properly formed and sealed together so as to prevent possible abrasions or injuries, i.e., no protrusions or gaps between sections. All protruding edges need to be deburred and polished so that there will be no cutting, pinching, puncture, or abrasion hazards. The permit for this type of facility will be invalidated, unless a good safety record is maintained.

(c) Details on submission of plans for waterslides must include:

(i) Detailed layout of the flumes indicating elevations, slopes, lengths of sections, and radius of each curve in the flumes.

(ii) Detailed cross sectional views of the flume on a straight away and going into all curves. The average water depth must be indicated.

(iii) Structural details of starting pools, flumes, landing pools, and if applicable, surge pools.

(iv) Total water volume for the whole waterslide facility.

(v) Top and profile views of the starting pool.

(vi) Top and profile views of the surge pool if applicable.

(vii) Top and profile views of the landing pool to include all equipment and applicable equipment spacing with all dimensions given or drawn to scale.

(d) Flume Design Criteria:

(i) The overall average slope of a flume shall conform to the design criteria of the recommendations of the ASTM F 2376, "Standard Practice for Classification, Design, Manufacture, Construction, and Operation of Water Slide Systems."

(ii) The slope of each flume section shall conform to the design criteria of the recommendations of the ASTM F 2376, "Standard Practice for Classification, Design, Manufacture, Construction, and Operation of Water Slide Systems."

(iii) Each flume shall be properly banked when used in any curved section; regardless of the degree of curvature. This is to properly ensure that the slider's body will remain within the flume.

(iv) Test runs down each channel shall be conducted to ensure its safety prior to formally opening the facility.

(v) A detailed engineering analysis of the flume structure must be submitted by the engineer assuming responsibility for the facility to ensure the strength and integrity of the material and structure under all circumstances.

(vi) Distance between the side of a flume exit and a landing pool wall shall be a minimum of five (5) feet.

(vii) Distances between sides of adjacent flume terminuses shall be a minimum of six (6) feet.

(viii) The distance between a flume exit and the opposite side of the landing pool or other obstruction(s) shall be a minimum of twenty (20) feet.

(ix) Flumes shall terminate a maximum of two (2) inches above the water surface and the flume must be level for a minimum distance of ten (10) feet from the flume's end. Flumes cannot terminate at an angle.

(x) Safe entry into the landing pool shall be provided through a deceleration distance of at least twenty (20) feet.

(e) In addition to requirements for public swimming pools the following must also be met:

(i) A one hour filter turnover time is required.

(ii) Where night use is allowed, area lighting of at least two (2) watts per square foot of deck area shall be provided at the landing pool, along the slide, and at the starting pool.

(iii) Adequate supervision of all slide flumes entry and exit points must be provided.

(f) All items not covered above with regard to Type "E" Pools shall use the current edition of the ASTM F 2376, "Standard Practice for Classification, Design, Manufacture, Construction, and Operation of Water Slide Systems" as guidelines.

4. Lazy Rivers. Lazy rivers with volumes of 60,000 gallons or greater shall have a minimum turnover time of six (6) hours. Those with volumes less than 60,000 gallons shall have a minimum turnover time of four (4) hours.

5. Wave Pool, Activity Pools and Kiddie Play Parks. Wave and activity pools with volumes of 60,000 gallons or greater shall have a minimum turnover time of six (6) hours. Those with volumes less than 60,000 gallons shall have a minimum turnover time of four (4) hours. Kiddie Play Parks shall have a minimum turnover time of one (1) hour.

6. Recirculation System. A recirculation system consisting of pumps, motors, piping, filters, inlets, outlets, disinfecting and other water conditioning equipment and necessary accessories must be provided for water purification in accordance with water quality criteria contained herein and must be designed to completely turnover at the rate required in Paragraphs 4 and 5 above. The recirculation system shall be designed to operate on a twenty-four (24) hour basis. The normal pattern of recirculation developed must be fifty (50) percent flow through the overflow or skimming facilities and fifty (50) percent through the main drains. The recirculation system must be designed with adequate capacity such that one hundred (100) percent of the recirculation flow can pass through the overflow or skimming facilities and 100 percent through the main drain. Waterparks may have several pools on one (1) main recirculation system provided it is proven to the Department that each pool meets the required turnover rate and the Department finds the overall design acceptable.

7. Automatic Controllers. All new Type "E" pools with water volumes of 1,500 gallons or less, shall be equipped with automatic controls to provide adequate feed rate of halogen and pH adjustment chemicals in order to keep the disinfectant and pH at the required levels on a continuous demand basis. A warning light or indicator shall be provided in a visible location for supervisory

control. The device shall indicate absence of chemicals in feeders, improper adjustment of chemical dosage, or any other mechanical or operational malfunctions, e.g. recirculation flow stops.

8. Pool Deck. The pool deck must be constructed in accordance with R.61-51.C.6.

H. DESIGN OF TYPE "F" POOLS

1. Applicability. Requirements of this section are applicable to all new construction and alterations of existing public swimming pools.

2. Section C Applicable. In addition to meeting all other applicable requirements of these regulations as found in Section C, Type "F" pools must also meet the following requirements of this section.

3. Recirculation System.

(a) A recirculation system consisting of pumps, motors, piping, filters, inlets, outlets, disinfecting and other water conditioning equipment and necessary accessories must be provided for water purification in accordance with water quality criteria contained herein and must be designed to completely turnover the entire pool volume in six (6) hours.

(b) The recirculation system shall be designed to operate on a twenty-four (24) hour basis. The normal pattern of recirculation developed must be fifty (50) percent flow through the overflow or skimming facilities and fifty (50) percent through the main drains. The recirculation system must be designed with adequate capacity such that one hundred (100) percent of the recirculation flow can pass through the overflow or skimming facilities and one hundred (100) percent through the main drain.

4. Automatic Controllers. All new Type "F" pools with water volumes of 1,500 gallons or less, must be equipped with automatic controls to provide adequate feed rate of halogen and pH adjustment chemicals in order to keep the disinfectant and pH at the required levels on a continuous demand basis. A warning light or indicator shall be provided in a visible location for supervisory control. The device shall indicate absence of chemicals in feeders, improper adjustment of chemical dosage, or any other mechanical or operational malfunctions, e.g. recirculation flow stops.

5. Pool Deck. The pool deck must be constructed in accordance with R.61-51.C.6.

I. EQUIPMENT CHANGES AND ALTERATIONS

1. Applicability. All public swimming pools, no matter when constructed, must comply with the requirements of this section. A change order is required for any interior pool coating, equipment or structural modification which is not an identical replacement for the originally approved design. All change order requests must be approved by the Department in writing prior to commencement of work. The request must be made using the Swimming Pool Change Order Request Form.

2. Structural Changes. In addition to a change order request, plans and specifications detailing any proposed alteration or modification requiring structural changes that affect the shape or structural components of a public swimming pool must be submitted following the requirements of Section B of these requirements, including submission of the appropriate fee.

3. Equipment Changes. Written notification detailing any proposed equipment changes which do not conform to original approved specifications must be submitted to the Department in writing on an approved change order request form. The request must be approved by the Department before any equipment can be installed on any public swimming pool. Equipment must comply with the requirements of Section C of these regulations.

4. Pump and Filter Changes. If proposed equipment changes involve the pump and filter, reasonable effort must be made to comply with the turnover rates specified in these regulations. Equipment room piping must be upgraded where necessary to meet these regulations when replacing both the pump and filter.

5. Deck Changes. A change order request must be submitted detailing the proposed work. If replacing existing decking, painting or resurfacing, the new decking must comply with applicable portions of R.61-51.C.6 and R.61-51.C.7. Temporary pool enclosures may be installed with prior Department approval provided that they do not hinder or limit access by emergency personnel and minimum deck widths are maintained. Adequate lighting must be provided if the facility will be used for night swimming.

6. Pool Resurfacing and Painting. A change order request must be submitted stating the type of material and color to be used. The Department may request manufacturer's literature and specifications for new or non-conventional products. The work must meet the applicable portions of Sections C, D, E, F, G, and H.

7. Piping Changes. A change order is required for piping changes beyond routine repair. In addition to a change order request, plans and specifications detailing any proposed alteration requiring piping changes that affect the location or pipe size of the overall recirculation system or a major fraction of the system of a public swimming pool must be submitted following the requirements of Section B of this regulation, including submission of the appropriate fee. When replacing pipe, a reasonable effort must be made to comply with applicable portions of R.61-51.C.24.

8. New Construction. Changes to new construction prior to completion must be approved by change order prior to any inspection. As-built drawings meeting the requirements of Section B must be approved by the Department prior to the final inspection.

9. Slides. The addition of slides to a previously approved pool will be permitted by:

(a) General change order when the slide is considered portable and intended only for children.

(b) Revised plans and specifications requiring a complete submittal in accordance with Section B when the installation will be permanent or have significant structural components.

10. Other Changes. All other changes from the originally permitted plans, specifications, or previously approved change orders must comply with these regulations where applicable.

J. OPERATION AND MAINTENANCE FOR ALL TYPE POOLS

1. Applicability. All public swimming pools, no matter when constructed, must comply with requirements of this section. All pools and pool equipment must be operated and maintained in accordance with the permitted plans and specifications or approved change order.

2. Operating Permits. No pool may operate without a valid operating permit. Operating permits are valid for a period of one (1) year beginning on April 1, and ending on March 31 of any calendar year. Operating permit fees are due by February 15 of each calendar year and are considered delinquent if not received by March 15th of each calendar year. The current operating permit must be prominently displayed at the pool on or near the pool rules sign.

3. Address and Ownership Changes. It shall be the owner's responsibility to notify the Department in writing of any address or ownership changes.

4. Housekeeping.

(a) The bathhouse and minimum toilet facilities must be kept clean with the floors and walls cleaned as often as necessary to maintain good sanitary conditions and kept as dry as possible. Showers must be scrubbed at least daily and proper disinfectant applied to the floors. All plumbing fixtures must be kept in good operating condition. Toilet paper and soap must be available in the dispensers at all times the pool is open. If public towels are provided, these towels must be laundered after each use. The pool, including walkways, diving boards, ladders, etc., must be kept clean. The surrounding grounds must be kept free of trash and litter. All pools must have a trash receptacle at the pool site.

(b) No glass of any kind or any other material that may be a hazard to bathers' feet or bodies will be allowed in the pool area. No furniture constructed with glass components may be located within the pool area.

5. Water Supply. All water used in public swimming pools, drinking fountains, bathhouse, or minimum toilet facilities, must be from a Public Drinking Water System which has been approved by the Department.

6. Drinking Water Fountain. Drinking water fountains, where installed, must be properly maintained. All electric drinking fountains must be equipped with ground fault interrupters.

7. Sanitary Sewage. The disposition of sanitary sewage from the bathhouse or minimum toilet facilities must be into a sanitary sewer, a septic tank, or other waste treatment facility which has been approved by the Department.

8. Equipment Enclosure. An enclosure must be provided to prevent unauthorized access to pool operating equipment. The structure shall protect the equipment from vandalism. This enclosure

must be of adequate height and size to enable required equipment maintenance and designed to drain away excess water. It must be adequately illuminated and ventilated. The equipment enclosure room is to be used specifically to house equipment for the pool's recirculation, filtration, and disinfection.

9. Recirculation System. The recirculation system must be operated on a twenty-four (24) hour basis during the swimming season unless it can be demonstrated by the owner or designated agent that water quality can be maintained with fewer hours of operation. The recirculation system must be operated during posted pool hours.

10. Accidents. Any death, injury, or accident requiring an EMS response, an emergency room visit, or hospitalization must be reported to the Department by the owner or designated agent in writing on a Department approved form within seventy-two (72) hours of the occurrence.

11. Safety Precautions.

(a) One or more lifeguards shall be on duty during operation hours at Type "A" and "E" pools. The minimum lifeguard requirements are listed in paragraph R.61-51.J.11(a)(i). Lifeguards must have their current certifications available for inspection while on duty. Lifeguards, when on duty, shall have no other duty but to supervise the swimmers.

(i) As a condition of obtaining and maintaining an operating permit, all Type "A" public swimming pools shall provide lifeguards in accordance with the following:

(A) A public swimming pool of three thousand (3,000) square feet or fewer must have:

- (1) One (1) lifeguard for one (1) through twenty-five (25) patrons;
- (2) Two (2) lifeguards for twenty-six (26) through fifty (50) patrons;
- (3) Three (3) lifeguards for fifty-one (51) through one hundred-fifty (150) patrons;
- (4) Four (4) lifeguards for one hundred fifty-one (151) through two hundred-fifty (250) patrons;
- (5) One (1) additional lifeguard for each one hundred patrons greater than two hundred-fifty (250) patrons

(B) A public swimming pool of three thousand one (3,001) square feet through six thousand (6,000) square feet must have:

- (1) Two (2) lifeguards for one (1) through twenty-five (25) patrons;
- (2) Three (3) lifeguards for twenty-six (26) through fifty (50) patrons;
- (3) Four (4) lifeguards for fifty-one (51) through one hundred-fifty (150) patrons;
- (4) Five (5) lifeguards for one hundred fifty-one (151) through two hundred-fifty (250) patrons;
- (5) One (1) additional lifeguard for each one hundred patrons greater than two hundred-fifty (250) patrons

(C) A public swimming pool of six thousand one (6,001) square feet through nine thousand (9,000) square feet must have:

- (1) Two (2) lifeguards for one (1) through twenty-five (25) patrons;
- (2) Three (3) lifeguards for twenty-six (26) through fifty (50) patrons;
- (3) Five (5) lifeguards for fifty-one (51) through one hundred-fifty (150) patrons;
- (4) Six (6) lifeguards for one hundred fifty-one (151) through two hundred-fifty (250) patrons;
- (5) One (1) additional lifeguard for each one hundred patrons greater than two hundred-fifty (250) patrons

(D) A public swimming pool of greater than nine thousand (9,000) square feet must have:

- (1) Three (3) lifeguards for one (1) through twenty-five (25) patrons;
- (2) Four (4) lifeguards for twenty-six (26) through fifty (50) patrons;
- (3) Six (6) lifeguards for fifty-one (51) through one hundred-fifty (150) patrons;

(4) Seven (7) lifeguards for one hundred fifty-one (151) through two hundred-fifty (250) patrons;

(5) One (1) additional lifeguard for each one hundred patrons greater than two hundred-fifty (250) patrons

(ii) A public swimming pool that is required to have only one lifeguard shall, at all times, have at least one additional pool staff employee present and available to make an emergency call if necessary.

(iii) Any request for a variance from the lifeguard requirements listed in R.61-51.J.11(a)(i) must be made in writing and must include a site-specific evaluation that demonstrates proof of equivalency with the provisions in R.61-51.J.11(a)(i). The Department will consider the variance request and will provide written notice of its decision.

(iv) Lifeguard requirements for Type "E" public swimming pools.

(A) Type "E" pools shall submit to the Department a lifeguard coverage plan. The lifeguard coverage plan must contain notification that the pool chooses to follow the lifeguard requirements enumerated in R.61-51.J.11(a) for Type "A" pools or, in the alternative, provide the following information:

(1) A pool schematic or diagram that shows lifeguard positions or stations along with sightlines;

(2) The number of lifeguards used during all expected conditions of facility operations. The pool surface area and user loading must be taken into account;

(3) The plan must include references, standards, and information from pool safety consultants and or other experts in pool safety and lifeguard coverage.

(B) Upon Department approval, Type "E" public swimming pools shall provide lifeguards in accordance with their approved plan. Until approval is received, Type "E" pools must follow the lifeguard requirements enumerated in R.61-51.J.11(a) for Type "A" pools.

(b) Type "A" and "E" pools must be locked when not under lifeguard supervision. All pools must be locked when the pool area is not open for patrons.

(c) Each Type "E" facility must provide attendants during operation of the facility to control the spacing and number of patrons utilizing each ride and to ensure and maintain the safe egress of all sliders out of the landing pool.

(d) At least one unit of life saving equipment must be inside the fence and be within two hundred (200) feet walking distance from any point on the pool perimeter and must be readily accessible and functional during posted pool hours. Life saving equipment is not required for Type "C" and "D" pools. Shepard's crook and life ring are not required for Type "A" and "E" pools if rescue tubes are provided.

(e) For all Type "A" and "E" pools one unit of emergency equipment must be readily accessible and functional during posted pool operating hours.

(f) All Type A and E pools must have a first aid kit. This kit must be readily accessible during posted pool hours.

(g) A toll free emergency notification device to notify emergency personnel must be provided within a two hundred (200) foot walking distance of the pool and in a location that it is easily accessible during the hours that the pool is in operation. Only permanently-mounted notification devices are acceptable to the Department. Mobile, voice over internet, or cordless telephones are not an acceptable alternative to permanently-mounted emergency notification devices. The physical address of the pool must be displayed at the emergency notification phone or device in a manner that is permanent and weather resistant.

(h) Signs in accordance with R.61-51.C.28 must be posted in a conspicuous place in the pool area for all pools. A single sign, if used for multiple pools must be clearly visible from each body of water.

(i) All diving boards and handrails must be maintained in a safe condition. Handrails and ladders must be rigidly secured while the pool is in operation and must comply with R.61-51.C.35.

(j) The lifeline must be maintained in good condition and kept in place except when lap swimming or routine maintenance is conducted. The lifeline must conform to the requirements listed in R.61-51.D.2(b).

(k) All removable diving stands must be removed when not in use.

(l) Any automatic vacuum systems must be removed from the pool during the hours the pool is open to the general public. In-floor cleaning systems must not be in operation during hours that the pool is open.

12. Swimming Limit. The swimming limits are determined in accordance with R.61-51.C.34 and must be posted on the pool rules sign.

13. Water Clarity. The water must be sufficiently clear to plainly view the main drains from the deck of the pool at all times when the pool is open. The viewer must be able to clearly distinguish the type, shape, and number of gratings (openings) of the main drains when standing at the edge of the pool deck nearest that main drain.

14. Water Quality

(a) A pool water quality test kit must be available at the facility during posted operating hours. This kit's condition must allow for accurate readings of free chlorine, bromine, pH, and cyanuric acid, if used.

(i) The DPD method or methodology approved either by the USEPA or the current edition of Standard Methods must be used to obtain free chlorine/bromine levels.

(ii) Samples for water quality testing shall be obtained at poolside.

(b) The following levels must be maintained for all pools:

Chlorine	1 to 8 parts per million (ppm) free chlorine
Bromine	2.3 to 17.6 parts per million (ppm)
pH	7.0 to 7.8 standard units

(c) All outdoor pools using chlorine may be stabilized with cyanuric acid. When used, the cyanuric acid level must not exceed two hundred (200) parts per million for calendar year 2009, one hundred fifty (150) parts per million for 2010, and one hundred (100) parts per million beginning in 2011. Indoor pools need not be stabilized.

(d) There will be no hand feeding of chemicals while the pool is open for swimming. The pool shall remain closed until chemical levels are within Department approved limits.

(e) In all cases of biological or chemical contamination of the pool water, the pool shall be immediately closed and the facility operator shall follow all current Department guidance in addressing the contamination before reopening of the pool. Biological contamination such as fecal, blood, or other body fluids shall be treated using guidance published by the Centers for Disease Control (CDC) on their healthy swimming web site. Procedures other than those provided by the Department may be approved on a case-by-case basis.

15. Automatic Controllers. Where automatic controllers are installed, the equipment shall be maintained in proper operating condition at all times. This maintenance shall include all of the manufacturers periodic service and calibration schedules for the controller and associated monitoring equipment.

16. Pool Temperatures

(a) Pool, spa, lazy river, or other pool type temperatures shall not exceed 104 degrees Fahrenheit.

(b) The temperature of each heated Type "D" pool must be monitored and posted by one of the following ways:

(i) Every two hours and posted on the spa caution sign.

(ii) Continuously with automated equipment and the temperature displayed within sight of the spa.

(iii) A shatter-resistant thermometer placed in the spa so that spa users can read it.

17. Operation Reports.

(a) Daily operation reports shall be maintained at every public pool. These shall include, as a minimum, readings of chlorine/bromine and pH. Chlorine/bromine and pH shall be checked daily or more frequently during operating hours to ensure the facility maintains required water quality standards for chlorine/bromine and pH. Cyanuric acid levels, if applicable, must be checked and recorded weekly.

(b) Results must be annotated on a bound log, with consecutively numbered pages, that is acceptable to the Department. The date, time and actual numerical reading must be listed on the report. Instrument monitoring shall not be used in lieu of physical water sampling at poolside. The report must be initialed at each reading and signed by the pool operator or his/her designated agent.

(c) Reports must be available for Department staff at time of inspection. In addition, reports shall be maintained and available at the facility for the previous eighteen (18) months.

18. Pool Operator

(a) All public swimming pools shall be operated under the direction of a qualified swimming pool operator who holds a valid South Carolina Pool Operator's certification issued by a party approved by the Department. Specific criteria shall be established by the Department for this approval process.

(b) The pool operator of record must inspect each public swimming pool a minimum of three (3) times per week during operation. Results of this inspection shall be annotated in the facility's bound log book and initialed by the pool operator.

19. Depth Markers. All pools must comply with the depth marker requirements listed in R.61-58.C(7) when a Change Order Request Form has been approved by the Department for recoating or resurfacing of the interior of the pool or for resurfacing of the deck.

20. Bacteriological Quality. The Department may take samples as necessary for bacterial analysis for each pool. The Department may also require that the owner sample the pool water for fecal coliform and have it analyzed by a certified laboratory. Any such sample shall be analyzed for fecal coliform bacteria in accordance with approved drinking water standard methods. The presence of any fecal coliform bacteria will indicate unsatisfactory water quality and will result in facility closure until satisfactory results are obtained.

21. Inspection of Facilities and Sampling of Pool Water.

(a) All public pools must be accessible for inspection by authorized representatives of the Department during the posted pool operating hours unless a sign is posted indicating that the pool is closed. Equipment rooms and associated chemical storage areas must also be accessible during pool inspection.

(b) It is the owner's or designated agent's responsibility to correct those items not in compliance with these regulations.

22. Facility Closure. If the public swimming pool is closed for six (6) months or longer, the facility shall be appropriately covered with a commercially manufactured pool cover or drained of stagnant water, cleaned, and secured with a fence to prevent access. If drained, care should be taken to ensure that the facility is not damaged by subsurface hydro-static pressure. If a public swimming pool is to be permanently closed, for a period in excess of twenty-four (24) consecutive months, the pool shall be filled in or removed and the water and drainage connections removed. Once a pool is filled in, there should be no subsequent settling that causes water to pond. Facility closures require written notification to the Department.

23. Operating Permit Fees. The Department shall collect annual operating permit fees and late fees as specified in R. 61-30, *Environmental Protection Fees*.

24. Operation and Maintenance Variance. When a pool owner or designated agent desires to operate a public swimming pool under a standard other than specified in these regulations a

variance may be requested from the Department. Such a request must be submitted in writing and shall include a description of the standard proposed, identify the standard required by the regulation and include proof of equivalency. This request for a variance may be considered by the Department for approval. The Department's decision on such a variance will be final and will be made in writing.

K. POOL CLOSURES AND ENFORCEMENT

1. Closure of Public Swimming Pools.

(a) Public Swimming Pools are to be closed immediately by the owner or his/her designated agent under the following conditions:

(i) When a public pool has not been issued a valid annual operating permit from the Department.

(ii) When the required number of lifeguards are not on duty at Type "A" and Type "E" pools or Type "B" pools choosing to use certified lifeguards in lieu of the required "No Lifeguard on Duty" signs.

(iii) When any pool is cloudy such that the main drains are not visible and/or the number of openings in the main drain cannot be counted.

(iv) When any item of life saving equipment is missing, defective or not readily accessible in the pool area.

(v) When the telephone/emergency notification device is missing, defective, or not accessible.

(vi) When an imminent safety hazard exists that poses a threat of injury or illness to bathers.

(vii) When the free residual chlorine or equivalent halogen reading is less than 1.0 parts per million (ppm) or greater than 8.0 parts per million (ppm).

(viii) When the pH is less than 7.0 or greater than 7.8.

(ix) When the disinfection, recirculation, automated control system used to adjust water chemistry, or filtration system is not fully operational.

(x) When the pool log is not available or not properly maintained.

(xi) When fecal coliform is present in the pool water.

(xii) When the temperature of any type pool exceeds 104 degrees Fahrenheit.

(xiii) When "Pool Rules", "No Diving", spa "Caution", "No Lifeguard on Duty", or "Pool Operator" signs are not posted in accordance with R.61-51.C.28(a) through (f).

(xiv) When time limits specified by the Department have been exceeded for the correction, repair, or replacement of defective, missing, or unauthorized equipment.

(xv) When the facility fails to retain or produce proof of the services of a properly credentialed pool operator.

(xvi) When the existing pool perimeter fencing and/or entrance gate or door do not meet the requirements of R.61-51.C(8).

(b) Where the owner or designated agent fails to close, or is not available to close the swimming pool under any of the above circumstances, the Department shall close the swimming pool and post "No Swimming" signs.

(c) In every case of pool closure, one or more "No Swimming" signs shall be posted conspicuously around or inside the affected pool enclosure. The owner or designated agent shall require all swimmers to leave the pool water. When closed by the owner at Department request, the swimming pool may be reopened after the noted deficiencies have been corrected, unless Department reinspection is required. When the owner fails to comply with the Department's request for closure, the Department will post "No Swimming" signs and the facility may not reopen until a satisfactory Department reinspection occurs.

2. Automatic Controllars. Automatic chemical feeders may be required for installation on those swimming pools with a record of improper water chemistry.

3. Penalties and Enforcement. Penalties may be imposed and enforcement procedures shall be carried out by the Department in accordance with 1976 S.C. Code Ann. Sections 44-55-2370 and 44-55-2380.

HISTORY: Amended by State Register Volume 16, Issue No. 6, eff June 26, 1992; State Register Volume 19, Issue No. 6, eff June 23, 1995; State Register Volume 26, Issue No. 5, Part 1, eff May 24, 2002; State Register Volume 31, Issue No. 5, eff May 25, 2007; State Register Volume 33, Issue No. 6, eff June 26, 2009; State Register Volume 38, Issue No. 6, Doc. No. 4431, eff June 27, 2014.

Editor's Note

1990 Act No. 551, § 2, eff June 6, 1990, provides as follows:

“The department may use the authority of this act to enforce the requirements of an effective regulation relating to public swimming pools which were promulgated pursuant to Chapter 1, Title 44 of the 1976 Code so long as these requirements are consistent with the provisions of this act and until regulations are promulgated pursuant to the authority of this act.”

61-52. Repealed.

HISTORY: Former Regulation, titled Psittacine Birds. Repealed by State Register Volume 40, Issue No. 6, Doc. No. 4611, eff June 24, 2016.

61-54. [Repealed].

HISTORY: Former Regulation, titled Wholesale Commercial Ice Manufacturing, had the following history: Amended by State Register Volume 32, Issue No. 5, eff May 23, 2008. Repealed by SCSR 44-6 Doc. No. 4903, eff June 26, 2020.

61-55. [Repealed].

HISTORY: Former Regulation, titled Septic Tank Site Evaluation Fees, had the following history: Added by State Register Volume 25, Issue No. 6, eff June 22, 2001. Amended by State Register Volume 31, Issue No. 6, eff June 22, 2007. Repealed by SCSR 45-5 Doc. No. 4979, eff May 28, 2021.

61-56. ONSITE WASTEWATER SYSTEMS.

(Statutory Authority: S.C. Code §§ 44-1-140(11), 44-1-150, 44-55-825, 44-55-827, and 48-1-10 et seq.)

The following constitutes the history for 61-56, 100 through 800, unless otherwise noted.

HISTORY: Amended by State Register Volume 32, Issue No. 5, eff May 23, 2008.

TABLE OF CONTENTS:

- 100 Purposes and Scope
- 101. Definitions and References.
- 102. Onsite Wastewater System Site Evaluation and Fees.
- 103. Onsite Wastewater Systems.
- 104. Application, Permit, Final Inspection and Approval, and Variances and Exemptions.
- 200. Minimum Site Conditions for Onsite Wastewater Systems.
- 201. Minimum Requirements for Onsite Wastewater System Primary Treatment.
- 202. Minimum Requirements for Onsite Wastewater System Final Treatment and Disposal Systems.
- 203. Onsite Wastewater System Construction Criteria.
- 204. Evaluation of Alternative Infiltration Trench Products.
- 300. Wastewater Treatment Facility Accessibility.
- 301. Discharge of Waste.
- 302. Changes in Use That Impact Existing Onsite Wastewater Systems.
- 400. Appendices of Standards for Permitted Systems.
- Appendix A - System Standard 100/101 - Conventional with 14-Inch Aggregate Depth.
- Appendix B - System Standard 150 - Large (greater than 1500 gpd) and Community Systems.
- Appendix C - System Standard 210/211 - Shallow Placement with 9-Inch Aggregate Depth.
- Appendix D - System Standard 220/221 - Shallow Placement with 6-Inch Aggregate Depth.

Appendix E - System Standard 230/231 - Shallow Placement with 14-Inch Aggregate Depth with Fill Cap.

Appendix F - System Standard 240/241 - Ultra Shallow Placement with 6-Inch Aggregate Depth with Fill Cap.

Appendix G - System Standard 250/251 - Reservoir Infiltration System for Soils with Expansive Clay.

Appendix H - System Standard 260/261 - 9-Inch Shallow Placement System with Fill Cap.

Appendix I - System Standard 270/271 - Alternative Trench Width and Depth Systems.

Appendix J - System Standard 280/281 - Reservoir Infiltration System for Soils with Expansive Clay Shallow Rock Formations.

Appendix K - System Standard 290/291 - Alternative Trench Width and Depth Systems with Fill Cap.

Appendix L - System Standard 370/371 - Shallow Placement with Fill Cap for Sites with Shallow Class IV Soil.

Appendix M - System Standard 380/381 - Double Aggregate Depth Wastewater Infiltration Trenches.

Appendix N - System Standard 420/421 - Mounded Infiltration System.

Appendix O - System Standard 431 - Mounded Fill System.

Appendix P - System Standard 601 - Elevated Infiltration System.

Appendix Q - System Standard 610 - Specialized Onsite Wastewater System Designs (less than 1500 gpd).

Appendix R - Curtain Drain Standard.

Appendix S - Nonwater Carried Sewage Treatment Systems.

Appendix T - Wastewater Combustion Systems.

Appendix U - Gray Water Subsurface Reuse Systems.

500. Long Term Acceptance Rate Standard for Onsite Wastewater Systems.

501. Peak Sewage Flow Rate Standard.

502. Onsite Wastewater Pump System Standard.

503. Minimum Design Standards for Tank Construction.

504. Fiberglass Reinforced Plastic Tanks Standard.

505. Thermoplastic Tanks Standard.

600. License to Clean Onsite Wastewater Systems, Self-Contained Toilets, and Other Sewage Holding Systems (i.e., Licensing of Pumper/Haulers).

601. Vehicles, Equipment, and Practices.

602. Records of Operation.

700. License to Construct or Repair Onsite Wastewater Systems (i.e., Licensing of Installers).

701. Continuing Education and Training.

702. Practice, Procedure, and Quality Control.

703. Bonding and Insurance Requirements: Tier 3 Installers.

704. Transition to Tiered Licensure.

800. Enforcement.

801. Severability Clause.

100. Purposes and Scope.

(1) A major factor influencing the health of individuals where public wastewater treatment facilities are not available is the proper onsite treatment and disposal of domestic wastewater. Diseases such as dysentery, cholera, infectious hepatitis, typhoid, and paratyphoid are transmitted through the fecal contamination of food, water, and the land surface largely due to the improper treatment and disposal of domestic wastewater. For this reason, every effort should be made to prevent such hazards and to treat and dispose of all domestic wastewater through the practical application of the most effective technology available.

(2) Safe treatment and disposal of domestic wastewater is necessary to protect the health of families and communities, and to prevent the occurrence of public health nuisances. Domestic wastewater can be rendered ecologically safe and public health can be protected if such wastes are disposed of so that:

- (a) They will not contaminate any drinking water supply.
- (b) They will not give rise to a public health hazard by being accessible to insects, rodents, or other possible carriers, which may come into contact with food or drinking water.
- (c) They will not give rise to a public health hazard by being accessible to children or adults.

(d) They will not violate federal and state laws or regulations governing water pollution or sewage disposal.

(e) They will not pollute or contaminate any waters of the state.

(f) They will not give rise to a public health nuisance.

(3) Where the installation of an onsite wastewater system is necessary, the basic principles of design, construction, installation, operation and maintenance shall be followed.

HISTORY: Amended by SCSR 45-5 Doc. No. 4979, eff May 28, 2021.

101. Definitions and References.

101.1. Definitions.

Accessibility - S.C. Code Sections 44-55-1410 and 5-31-2010 authorizes county and municipal governments to determine if a wastewater treatment facility is accessible to properties. Where annexation or easements to cross adjacent property are required to connect to a wastewater treatment facility, the wastewater treatment facility shall not be considered accessible.

Alternative System - A system incorporating design modifications of the proposed subsurface wastewater infiltration trench area (drain field) or absorption trench geometry for the purpose of achieving compliance with required setbacks and offset to the zone of saturation and/or restrictive horizons. No such system shall be utilized unless the Department has established a specific standard.

Alternative Infiltration Trench Products - Products specifically designed to replace or eliminate the aggregate typically utilized in subsurface infiltration trenches. Such products must be approved for use by the Department and must adhere to required equivalency values established herein.

Applicant - A property owner, general contractor or agent representing the property owner, or developer who seeks a permit to construct and operate an onsite wastewater system.

Bond - A sum of money set aside (Surety Bond) to insure completion of work under a contract.

Campground - An organized camp in which campsites are provided for use by the general public or certain groups.

Canal - An artificial waterway used for navigation, drainage, or irrigation.

Cleaning - The removal and transportation of septage from an onsite wastewater system, self-contained toilet, or other sewage holding system to an approved disposal location.

Color Charts (Munsell System or equivalent) - Charts bearing various color chips established by a recognized color system which uses three elements-hue, value, and chroma-to make up a specific color notation. The notation is recorded in the form of hue, value, and chroma (e.g., 10YR 5/6). The three attributes of color are arranged in the system in orderly scales of equal visual steps, which are used to measure and describe color accurately under standard conditions of illumination by comparing soil samples to color chips on various charts.

Construction - The installation, upgrade, or expansion of an onsite wastewater system.

Conventional System - An onsite wastewater system that utilizes a network of conventional wastewater infiltration trenches installed in the naturally occurring soil for the treatment and disposal of domestic wastewater.

Critical Area - S. C. Code Section 48-39-10(J) defines critical area as the following: 1) coastal waters; 2) tidelands; 3) beaches; 4) beach/dune systems which are the areas from the mean high-water mark to the setback line as determined in S. C. Code Section 48-39-280.

Curtain Drain - A subsurface interceptor drain that is installed to collect and redirect groundwater as it flows through the soil profile to an appropriate discharge point.

Department - The South Carolina Department of Health and Environmental Control.

Ditch - A long narrow excavation intended for the purpose of drainage and/or irrigation.

Domestic Wastewater - The untreated liquid and solid human body waste and the liquids generated by water-using fixtures and appliances, including those associated with food service operations. For the purposes of this regulation, domestic wastewater shall not include industrial process wastewater.

Dwelling - A self-contained unit used by one (1) or more households as a home, such as a house, apartment, mobile home, house boat, tiny house, park model RV, RV or camper, or other substantial

structure that provides living facilities for one (1) or more persons, including permanent or semi-permanent provisions for living, sleeping, eating, cooking, and sanitation.

Effluent - The liquid discharged from a septic tank, effluent pump station, or other sewage treatment device.

Embankment - A bank of soil with at least two (2) feet of vertical height from top to bottom.

Environmentally Sensitive Waters - Outstanding resource waters (ORW), Shellfish Harvesting Waters (SFH), and Trout-Natural Waters (TN) as defined in R.61-68 and classified in R.61-69, and including lakes greater than forty (40) acres in size and the Atlantic Ocean, regardless of their classifications in R.61-69.

Existing System - An onsite wastewater system, which has received final construction approval or has been serving a legally occupied dwelling or structure.

Expansive Soils - Soils containing significant amounts of expansible-layer clay minerals (smectites) as evidenced in the field by classifications of "Very Sticky," "Very Plastic" and where "Slickensides" are present when evaluated in accordance with the Field Book. Such soil horizons are considered to be restrictive for onsite wastewater systems.

Failing Onsite Wastewater System - An onsite wastewater system that is discharging effluent in an improper manner or has ceased to function properly.

Fiberglass Reinforced Plastic - A fibrous glass and plastic mixture that exhibits a high strength to weight ratio and is highly resistant to corrosion.

Field Book for Describing and Sampling Soils (Field Book) - A field guide published by the U.S. Department of Agriculture (USDA) Natural Resources Conservation Service (NRCS) for making or reading soil descriptions and for sampling soils, as presently practiced in the USA.

Final Treatment and Disposal - Ultimate disposition of the effluent from a septic tank or other treatment device into the soil.

Flexural Modulus of Elasticity - A measure of stiffness of a material.

Flexural Strength - A measure of the ability of a material to withstand rupture when subjected to bend loading.

Gel Coating - A specially formulated polyester resin, which is pigmented and contains filler materials, the purpose of which is to provide a smooth, pore-free, watertight surface for fiberglass reinforced plastic parts.

Gleying - Bluish, greenish, or grayish colors in the soil profile that are indicative of markedly reduced conditions due to prolonged saturation. This condition can occur in both mottled and unmottled soils, and can be determined by using the gley page of the soil color charts.

Gray Water - Domestic wastewater that is generated by water-using fixtures and appliances such as sinks (excluding kitchen sinks), showers, and laundry but that does not come into direct contact with human excreta or solid organic matter.

Gray Water Subsurface Reuse Systems - A system designed to separately collect and treat gray water and subsequently dispose of gray water by reusing it as part of a subsurface irrigation system. This definition does not include any system designed to reuse gray water for any purpose, or by any means, other than subsurface irrigation. This definition also does not include any system that reuses or recirculates gray water within the confines of (i.e., via the plumbing within) a dwelling unit, building, business, or other structure.

Grease Trap - A device designed to separate and store the oil and grease component of wastewater discharged from facilities that prepare food.

Industrial Process Wastewater - Non-domestic wastewater generated in a commercial or industrial operation that may or may not be combined with domestic wastewater.

License - The official document issued by the Department authorizing a person to be responsible for the construction, repair, or cleaning of onsite wastewater systems, self-contained toilets, and other sewage holding systems.

Licensed Onsite Wastewater System Installer (Installer) - A person authorized under this regulation to construct or repair onsite wastewater systems. The specific scope of activities authorized depends on the installer's tier of licensure, as follows:

(1) Tier 1 - May install all gravity-fed residential onsite wastewater systems. This level is not authorized to conduct repairs on existing onsite wastewater systems.

(2) Tier 2 - May install all Tier 1 systems plus pumps, grease traps, systems with curtain drains, elevated infiltration systems, mounded systems, and all commercial onsite wastewater systems, large onsite wastewater systems, and community onsite wastewater systems. This level is also authorized to conduct repairs on existing onsite wastewater systems.

(3) Tier 3 - May install all Tier 1 and 2 systems plus all Standard 610 - Specialized Onsite Wastewater Systems. This level is also authorized to conduct repairs on existing onsite wastewater systems.

Long-Term Acceptance Rate (LTAR) - The long-term rate, typically expressed in gallons per day (gpd) per square foot of trench bottom area, at which a mature onsite wastewater system can continue to accept effluent without hydraulic failure occurring. This flow rate is a result of the interaction between unsaturated soil hydraulic conductivity and biomat resistance.

Mottling - Morphological features of the soil revealed as spots or blotches of different color or shades of color interspersed with the dominant matrix color.

NSF Standard #14 - A National Sanitation Foundation Standard relating to thermoplastics which have been tested and found satisfactory for potable water supply uses, drains, waste, and vent applications.

Nonwater-Carried Sewage Treatment System - A self-contained system for waste treatment (such as a biological, composting, or incinerating toilet) that stores, treats, and renders human urine and feces inert without the use of water and that is designed to not discharge into the soil, onto the soil surface, into bodies of water, or other external media.

Onsite Wastewater (OSWW) System - A system, generally consisting of a collection sewer, septic tank(s), and subsurface wastewater infiltration area, designed to treat and dispose of domestic wastewater through a combination of natural processes that ultimately result in effluent being transmitted through the soil, renovated, and ultimately discharged to groundwater. An onsite wastewater system shall also include an onsite wastewater system, as described above, for the treatment and disposal of gray water.

(1) Small Onsite Wastewater System - An individual system serving an individually deeded dwelling or business that generates less than fifteen hundred (1500) gpd of domestic wastewater. Management and maintenance of each system is the responsibility of the individual property owner.

(2) Large Onsite Wastewater System (General) - An individual system that treats and disposes of domestic wastewater discharges in excess of fifteen hundred (1500) gpd.

(a) Privately Owned Large System - A large onsite wastewater collection and treatment system that serves one (1) piece of deeded property such as a school, adult residential care facility, rental apartment complex, shopping center, campground, mobile home park, office complex, etc. Management and maintenance of the system is the responsibility of the individual property owner.

(b) Community (Cluster) System - A wastewater collection and treatment system that provides shared collection, treatment, and disposal of domestic wastewater from multiple parcels or multiple units of individually deeded property. Such a system might serve a small subdivision or a condominium complex. It is imperative with such systems that some form of common ownership and management be established and approved by the Department.

(c) Commercial Onsite Wastewater System - An onsite wastewater system generating domestic wastewater or sewage that serves a facility, other than a private dwelling, intended for the engagement of commerce.

Operation and Maintenance - Activities including tests, measurements, adjustments, replacements, and repairs that are intended to maintain all functional units of the onsite wastewater system in a manner that will allow the system to function as designed.

Other Sewage Holding System - Components of a sewer system or holding tank not related to an onsite wastewater system, including grease traps.

Parent Material - The unconsolidated and chemically weathered mineral or organic matter from which the column of soils is developed by pedogenic processes.

Perched Zone of Saturation (Episaturation) - A zone of saturation above an unsaturated zone.

Permit - A written document or documents issued by the Department authorizing the construction and operation of an onsite wastewater system, nonwater-carried sewage treatment system, wastewater combustion system, or gray water subsurface reuse system under this regulation. The term "permit" includes the permit to construct and the approval to operate, both of which are required prior to operation of a system under this regulation. Upon installation of a permitted system and Department issuance of an approval to operate, the construction and operation permit remains in effect for the life of the onsite wastewater system that it authorizes.

Plasticity - The degree to which "puddled" or reworked soil can be permanently deformed without rupturing. The evaluation is made in accordance with the Field Book by forming a roll (wire) of soil at a water content where the maximum plasticity is expressed.

Primary Treatment - The initial process to separate solids from the liquid, digest organic matter, and store digested solids through a period of detention and biological conditioning of liquid waste.

Professional Soil Classifier ("PSC") - A person who, by reason of special knowledge of the physical, chemical, and biological sciences applicable to soils as natural bodies and of the methods and principles of soil classification as acquired by soils education and soil classification experience in the formation, morphology, description, and mapping of soils, is qualified to practice soil classifying and has been duly licensed by the South Carolina Soil Classifiers Advisory Council as a Professional Soil Classifier in South Carolina.

Public Entity - Any organizations such as a city, town county, municipality, or special purpose sewer district.

Public Water System - Any publicly or privately owned waterworks system that provides drinking water for human consumption as defined in R.61-58, State Primary Drinking Water Regulations.

Pump Chamber - A watertight, covered receptacle designed and constructed to receive and store the discharge from a septic tank until such time that the effluent is pumped to a final treatment and disposal site.

Pumping and Transporting Vehicle - A vehicle approved by the Department for the cleaning of onsite wastewater systems, self-contained toilets, and other sewage holding systems and the transporting of septage and sewage to an approved disposal site.

Receptor - Any water well or surface water of the state, including estuaries.

Redox Depletions - Morphological features that are formed by the processes of reduction and translocation of iron and manganese oxides in saturated soils. These features may be revealed as spots, blotches, or streaks and are lighter shades of color compared with the dominant matrix color.

Redoximorphic Features - Morphological features that are formed by the processes of reduction, translocation, and oxidation of iron and manganese oxides in saturated soils. These include redox concentrations, redox depletions, and reduced matrices.

Registered Professional Engineer - A person licensed as a Professional Engineer by the South Carolina State Board of Registration for Professional Engineers and Surveyors who, by reason of special knowledge of the mathematical and physical sciences and the principles and methods of engineering analysis and design, acquired by professional education and practical experience, is qualified to practice engineering as attested by the person's license and registration as a Professional Engineer in South Carolina.

Remote Subsurface Wastewater Infiltration Area - A subsurface wastewater infiltration area that is not situated within the legal boundaries of the primary lot or tract that it serves.

Repair - Any work performed on an existing onsite wastewater system for the purposes of correcting a system failure, malfunction, or unauthorized discharge, enhancing system performance, or relocation or replacement of the entire system or system components, provided there are no changes in use that would impact the existing system.

Repair or Replacement Area - An area identified on the permit to construct reserved for the installation of additional wastewater infiltration trenches.

Restrictive Horizon - A soil horizon that is capable of severely retarding the movement of groundwater or effluent and may be brittle and cemented with iron, aluminum, silica, organic matter, or other compounds. Restrictive horizons may occur as fragipans, iron pans, organic pans, or shallow rock formations and are recognized by their resistance in excavation and auger boring.

Resin - Any number of commercially available polyester products used in the manufacture of fiberglass reinforced products which serve to contribute mechanical strength, determine chemical and thermal performance, and prevent abrasion of fibers, and which must be physically and/or chemically determined to be acceptable for the environment, and free from inert filler materials.

Revocation - The permanent withdrawal of rights and privileges granted by a license or an onsite wastewater system permit or approval, as applicable.

Rippable Rock - The rippability of rock material is a measure of its ability to be excavated with conventional excavation equipment (e.g., rubber-tired backhoe).

Saprolite - Soft, friable, thoroughly decomposed rock that has formed in place by chemical weathering, retaining the fabric and structure of the parent rock, and being devoid of expansive clay. Unconsolidated saprolite can be dug using a hand auger or knife. Consolidated saprolite cannot be penetrated with a hand auger or similar tool, and must be dug with a backhoe or other powered equipment.

Sealant - A bonding agent specifically designed to bond joining sections of fiberglass reinforced plastic products to each other in such a manner to create a durable, long-lasting, watertight seal, which does not alter the structural integrity or strength of the two (2) joined fiberglass products.

Self-Contained Toilet - A single or multiple-unit toilet and holding tank combination.

Septage - The mixture of solids and liquids removed during cleaning of a septic tank, grease trap, any other part of an onsite wastewater system, self-contained toilet, or other sewage holding system which receives domestic sewage; this includes the liquid, solid, and semi-solid materials which settle to the bottom of transport containers.

Septic Tank - A watertight, covered receptacle designed and constructed to receive the discharge of domestic wastewater from a building sewer, separate solids from the liquid, digest organic matter, store digested solids through a period of detention and biological conditioning of liquid waste, and allow the effluent to discharge for final treatment and disposal.

Serial Distribution - A method for effluent distribution on sloping terrain that utilizes drop boxes or earthen dams to affect total sequential flow from upper to lower wastewater infiltration trenches.

Sewage - Any liquid waste containing human, animal, vegetable, or chemical matter in suspension or solution from water closets, urinals, lavatories, bathtubs, laundry tubs or devices, floor drains, drinking fountains, or other water-using fixtures.

Site - The area or plot of land identified by a plat, deed, or other legal document specifying lot size and its boundaries that is submitted for evaluation by an applicant in an onsite wastewater system permit application.

Site Evaluation - Evaluation of the soil, geology, zone of saturation, surface waters, topography, structures, and property lines of the proposed location of the onsite wastewater system. The evaluation can be conducted directly by certified Department personnel or the Department may conduct an evaluation through the review of information submitted by a licensed person meeting the criteria of Section 102.1(2)(b) or (c).

Soils Report - A report prepared by a licensed person meeting the criteria of Section 102.1(2)(b) or (c) describing soil and site conditions for the purpose of designing an onsite wastewater system.

Soil Structure - The aggregation of primary soil particles (i.e., sand, silt, and clay) into compound particles or clusters of primary particles which are separated from the adjoining aggregates by surfaces of weakness. In soils with platy structure, the aggregates are plate-like and overlap one another to severely impair permeability. A massive condition can occur in soils containing considerable amounts of clay when a portion of the colloidal material, including clay particles, tends to fill the pore spaces making the soil very dense.

Soil Texture - The relative proportions of the three soil separates (sand, silt, and clay) in a given sample of soil. The percentages of each separate are used to determine which class a particular sample falls into by plotting the intersection of these three values on the U.S. Department of Agriculture (USDA) Natural Resource Conservation Service (NRCS) Textural Triangle.

Standard 610 - Specialized Onsite Wastewater System Design (less than 1500 gpd) - An onsite wastewater system that is certified to function satisfactorily and in accordance with all requirements of this regulation by virtue of it having been designed by a Registered Professional Engineer (PE) licensed in South Carolina with technical input from a licensed person meeting the criteria of Section 102.1(2)(b) or (c). Such systems have limited application and can only be utilized when the required engineering design, certification, and technical soils documentation have been provided to and accepted by the Department.

Standard - A group of requirements developed by the Department that specifies the minimum site conditions and design criteria necessary for the approval of a specific type of onsite wastewater system. A standard may also address minimum design criteria for certain components of onsite wastewater systems as well as methodologies for determining system sizing.

Stickiness - The capacity of soil to adhere to other objects. Stickiness is estimated in accordance with the Field Book at the moisture content that displays the greatest adherence when pressed between the thumb and forefinger.

Subdivision - Means all divisions of a tract or parcel of land into two (2) or more lots, building sites, or other divisions, for the purpose, whether immediate or future, of sale or building development, and includes all division of land involving a new street or a change in existing streets, and includes resubdivision. This definition shall apply whether the lots are to be sold, rented, or leased. This definition shall not apply when the division or partition of the land, or the conveyance of property is pursuant to a will, an intestacy statute, or an order by a probate judge.

Subsurface Wastewater Infiltration Area (Drain Field) - A specific area where a network of wastewater infiltration trenches or other devices of sewage application are installed to provide the final treatment and disposal of effluent.

Suspension - The temporary or indefinite withdrawal or cessation of rights and privileges granted by a license or onsite wastewater system permit or approval, as applicable.

Third-Party - A qualified person or entity, as determined by the Department, that is independent of the parties involved.

Ultimate Tensile Strength - A measure of the resistance of a material to longitudinal stress, measured by the minimum longitudinal stress required to rupture the material.

Upgrade/Expansion - Any work performed on an existing onsite wastewater system for the purposes of increasing the capacity of the system above its original design and/or accommodating wastes of a different character than was originally approved.

Variance - Means a written document issued by the Department that authorizes a modification or waiver of one or more requirements of this regulation, if in the opinion of the Department, a health hazard or nuisance will not result from the modification or waiver.

Wastewater Characteristics - The physical, chemical, and biological parameters and characteristics of domestic wastewater. Physical characteristics include turbidity, color, odor, total suspended solids (TSS), temperature and fats, oils and grease (FOG). Chemical characteristics include the presence and extent of chemical oxygen demand (COD), total organic carbon (TOC), Total Kjeldahl Nitrogen (TKN), nitrogen, phosphorous, chlorides, sulfates, alkalinity, pH, heavy metals, trace elements, and priority pollutants identified by the U.S. Environmental Protection Agency (EPA). Biological characteristics include biological oxygen demand (BOD), oxygen required for nitrification and microbial population. High strength wastewater is characterized as meeting one (1) or more of the following levels: BOD > 350 mg/l, TSS > 100 mg/l, TKN > 100 mg/l, FOG > 30 mg/l.

Wastewater Combustion System - A self-contained system for wastewater treatment that uses water as a medium for transport and storage. It treats and renders wastewater inert using maceration and incineration.

Wastewater Infiltration Trench - A trench installed in the naturally occurring soil that is utilized for the treatment and disposal of domestic wastewater.

Wastewater Treatment Facility - An accessible publicly or privately owned system of structures, equipment, and related appurtenances that treat, store, or manage wastewater.

Zone of Saturation - Any zone in the soil profile that has soil water pressures that are zero or positive at some time during the year. For the purpose of this regulation, the beginning of such a zone shall be

utilized in determining all required vertical separations from the deepest point of effluent application. This zone shall be defined as the shallowest of those points at which either redox depletions of value four (4) or more and chroma two (2) or less appear or gleying is first observed; or, in the absence of other field identification methods, the maximum groundwater elevation as determined by wet season monitoring performed in accordance with criteria approved by the Department.

101.2. References.

The following manufacturing and procedural standards referenced in this regulation are those in force on the effective date of this revision:

- (1) American Society of Agronomy (ASA)
- (2) ASTM International C
- (3) ASTM International D
- (4) CSA Group
- (5) Crop Science Society of America (CSSA)
- (6) International Association of Plumbing and Mechanical Officials (IAPMO)
- (7) National Building Specification (NBS) Voluntary Product Standard PS 15-69
- (8) National Electrical Manufacturers Association (NEMA)
- (9) Soil Science Society of America (SSSA)

HISTORY: Amended by State Register Volume 40, Issue No. 5, Doc. No. 4591, eff May 27, 2016; SCSR 45-5 Doc. No. 4979, eff May 28, 2021; SCSR 46-5 Doc. No. 5103, eff May 27, 2022.

102. Onsite Wastewater System Site Evaluation and Fees.

102.1. Site Evaluations.

(1) An applicant for a permit to construct an onsite wastewater system, nonwater-carried sewage treatment system, wastewater combustion system, or gray water subsurface reuse system shall, at the time an application for a permit to construct is submitted to the Department, pay to the Department the site evaluation fee set forth in Section 102.2.

(2) Soil evaluations shall be conducted only by:

(a) A certified Department staff member;

(b) A licensed Professional Soil Classifier or other licensed person qualified to practice soil classifying under S.C. Code 40-65-40(7) and otherwise deemed qualified by the Department who has contracted with the Department. The contractor may not charge a rate more than three (3) times the Department's permit fees; or

(c) A privately hired licensed Professional Soil Classifier or other licensed person qualified to practice professional soil classifying under S.C. Code Section 40-65-40(7), provided that the burden of documenting qualification under S.C. Code Section 40-65-40(7) is on the licensed professional. The licensed professional shall provide to the Department verification of licensure and confirmation from their licensing board that the person is qualified to practice professional soil classifying within the scope of their license. The Department will disallow a soil evaluation from any person not able to provide verification to the Department's satisfaction.

(3) Except as provided in Section 102.1(4) and 102.1(5), an onsite wastewater system layout in accordance with Section 400, Appendices of Standards for Permitted Systems, may be prepared by:

(a) A certified Department staff member;

(b) A Registered Professional Engineer licensed in South Carolina who is not Department staff and has subcontracted with the Department to prepare onsite wastewater system layouts at a rate not more than three (3) times the Department's permit fee; or

(c) A privately hired Registered Professional Engineer licensed in South Carolina or the same licensed person under Section 102.1(2)(b) or (c) who conducted the soil evaluation for the site.

(4) Only a Registered Professional Engineer may design a system and prepare a system layout for Standard 610/611 — Specialized Onsite Wastewater Systems, Standard 150 — Large and Community Onsite Wastewater Systems, nonwater-carried sewage treatment systems, wastewater combustion systems, and gray water subsurface reuse systems.

(5) The Department will not perform a soil evaluation or prepare a system layout for any subdivision or portion of a subdivision with ten (10) or more lots without access to all available utilities. Soil evaluations for any lots that are part of a subdivision with ten (10) or more lots without access to all available utilities must be conducted by a licensed person meeting the criteria of Section 102.1(2)(b) or (c). Proposed system layouts for any lots that are part of a subdivision must be prepared by a third-party Registered Professional Engineer or Professional Soil Classifier meeting the criteria under Section 102.1(3)(b) or (c). The Soils Report and proposed system layout must be submitted with the onsite wastewater system permit application for the purpose of the Department review and issuance of a permit to construct.

102.2. Fees.

The Department shall charge a fee of one hundred and fifty dollars (\$150.00) to evaluate the site of a proposed onsite wastewater system, nonwater-carried sewage treatment system, wastewater combustion system, or gray water subsurface reuse system.

102.3. Other.

Funds derived from these fees shall be used only for the provision of services and accompanying expenses associated with the Department's Bureau of Environmental Health Services programs.

HISTORY: Amended by State Register Volume 40, Issue No. 5, Doc. No. 4591, eff May 27, 2016; SCSR 45-5 Doc. No. 4979, eff May 28, 2021; SCSR 46-5 Doc. No. 5103, eff May 27, 2022.

103. Onsite Wastewater Systems.

103.1. General.

(1) Each dwelling, business, or other structure occupied for more than two (2) hours per day shall be provided with an approved method for the treatment and disposal of domestic wastewater.

(2) It shall be the responsibility of the property owner to ensure that a permit to construct and operate any new, upgraded, or expanded onsite wastewater system, nonwater-carried sewage treatment system, wastewater combustion system, or gray water subsurface reuse system is obtained from the Department prior to construction and operation of the system.

(3) No person shall begin construction of a dwelling, business, or other structure to be served by an onsite wastewater system, nonwater-carried sewage treatment system, wastewater combustion system, or gray water subsurface reuse system until a permit to construct and operate such a system is issued by the Department. Mobile or modular structures intended for occupancy shall not be moved onto the site until the permit to construct and operate an onsite wastewater system has been issued.

(4) The property owner shall be required to properly operate and maintain in good working order all onsite wastewater system(s) and their parts and to comply with all terms and conditions of a previously issued permit. System parts may include, but are not limited to, sealed watertight tanks, lid(s), piping, aggregate, pump, and pump components.

(5) An onsite wastewater system serving more than one (1) piece of deeded property shall be considered as a community or cluster collection and treatment system and shall comply with the following:

(a) A permit activity will not occur that is inconsistent with a plan or plan amendment approved under section 208(b) of the Clean Water Act unless the Department finds such variance necessary to protect the public's health, safety, and welfare.

(b) If a public entity owns the system, the entity shall be responsible for the operation, maintenance, and replacement of all components unless otherwise approved by the Department. The Department may consider a request from a private entity or person; however, such proposals must be evaluated on a case-by-case basis. The Department will evaluate the capability of long-term, reliable system operation in its evaluation of a permit request.

(c) If the project is owned by a private entity or person, the Department shall require financial assurances for the operation, maintenance, and replacement of the tank(s) and subsurface wastewater infiltration area system and relevant collection/pumping components.

(d) Sufficient area meeting the minimum requirements for large onsite wastewater systems shall be provided for at least one hundred (100) percent repair or replacement of the primary subsurface wastewater infiltration area.

(e) The collection sewer and pumping portions of a community onsite wastewater system shall receive a separate Construction Permit under R.61–67.300, Standards for Wastewater Facility Construction.

103.2. Large (greater than 1500 gpd) and community onsite wastewater systems incorporating advanced treatment methods, including but not limited to aerobic pre-treatment, lagoons, surface or subsurface drip irrigation, low pressure pipe distribution and other maintenance intensive methods, shall be required to obtain a Land Application Permit under R.61–9, Water Pollution Control Permits.

103.3. Facilities that generate industrial process or any other non-domestic wastewater shall not be granted a permit under this regulation unless the Department determines that the proposed discharge would not pose a significant environmental risk. In such a determination, the Bureau of Water would determine if the waste may cause a violation of any drinking water standard under R.61–58, State Primary Drinking Water Regulations, or may otherwise adversely affect the health of persons regardless of whether or not the wastewater is to be discharged continuously or intermittently to the onsite wastewater system. Plumbing appurtenances that facilitate the transport of such wastewater, including floor drains, trench drains, utility sinks, equipment drains, or any other conduit shall not be installed in facilities served by onsite wastewater systems unless specifically approved by the Department as a result of the above-described determination.

103.4. Campgrounds.

(1) Onsite wastewater systems serving campgrounds shall comply with all applicable requirements of this regulation. Such campgrounds shall be provided with adequate toilet and bathing facilities, except in those cases where all campsites are furnished with individual sewer service connections, and each site is exclusively designated for use by camping units equipped to access such connections.

(2) Individual sewer service connections shall be part of an approved sewage collection system and shall be equipped with removable, tight fitting covers.

(3) Where individual sewer service connections are not furnished at all campsites, an approved sanitary dump station(s) shall be provided at a convenient location(s) within the campground at the ratio of one (1) dump station per one hundred (100) campsites or fractions thereof.

(a) A dump station shall consist of one (1) or more trapped four (4) inch sewer risers surrounded by a concrete apron having a diameter of at least two (2) feet and sloped to drain. Sewer risers must be equipped with removable, tight fitting covers.

(b) Each dump station shall be equipped with pressurized water to be used for washing the concrete apron. The water outlet shall be protected from back siphonage by a vacuum breaker installed at its highest point, or by other approved means. A sign shall be placed at this water outlet stating: THIS WATER IS FOR CLEANING PURPOSES ONLY.

HISTORY: Amended by State Register Volume 40, Issue No. 5, Doc. No. 4591, eff May 27, 2016. Renumbered from 61–56.102 and amended by SCSR 45–5 Doc. No. 4979, eff May 28, 2021.

104. Application, Permit, Final Inspection and Approval, and Variances and Exemptions.

104.1. Application.

(1) The applicant shall furnish, in a format as identified by the Department, complete and accurate information necessary for determining the feasibility of an onsite wastewater system.

(2) The application shall include written permission from the property owner or their legal representative, using a form identified by the Department, for Department representatives to access the property.

(3) A boundary plat, deed, or other legal document specifying the lot size shall be furnished by the applicant. The applicant shall provide a legal description that specifies lot boundary lengths for lots two (2) acres or smaller in size and upon request for any lot greater than two (2) acres in size. When a dwelling or facility is to be served by a remote subsurface wastewater infiltration area, the applicant must provide appropriate easement(s). An appropriate easement must allow ingress and egress for construction, operation, maintenance, replacement and repair and must run with the land.

(4) Soil boring descriptions, backhoe pits, and soils classifications from specifically identified locations, including other tests or information, shall be required when deemed necessary by the Department.

(5) Backhoe pits shall be required above the Fall Line that separates the Piedmont area from the Coastal Plain as defined by the South Carolina Geological Survey.

(6) Before a site evaluation of the lot is performed by the Department, the applicant shall be required to: clear and mark pertinent property boundary lines and corners; post an identification marker in the front center of the lot; place stakes at the corners of the proposed building; mark the proposed point of stub-out and septic tank as well as proposed drain field area; locate the proposed or existing well location; and identify the proposed location of any additional structures or facilities on the property that may influence the placement and configuration of the onsite wastewater system. A site sketch shall be included on the application or as a separate attachment that reflects the items above and any other items specified on the application. The applicant may be required to clear underbrush from the property in order to facilitate the evaluation.

(7) The Department will not issue a permit if it determines that site conditions are unsuitable for the system layout or permit requested, or if issuance of the permit would otherwise be inconsistent with the requirements of this regulation. The Department also reserves the right to modify a proposed system layout submitted by a licensed person under Section 102.1(3)(c) when deemed appropriate.

104.2. Permit.

(1) It shall be unlawful to construct, upgrade, expand, or operate an onsite wastewater system, nonwater-carried sewage treatment system, wastewater combustion system, or gray water subsurface reuse system unless the Department has issued a permit to construct and approval to operate for the specific construction and operation proposed. The system shall be constructed and operated in accordance with the permit, and the Department must authorize any changes prior to the construction and operation of the system. The applicant shall be required to make a written request for any desired permit modifications. The applicant shall submit a new application with a new site evaluation fee for permit modifications that require an additional site evaluation. The Department may also require a permit to construct and approval to operate for the repair, relocation, or replacement of an onsite wastewater system or its components when deemed necessary, irrespective of whether any change in use impacting the existing onsite wastewater system would occur. The property owner or their legal representative shall notify the Department before relocating or replacing an onsite wastewater system or its components so that the Department may determine whether a permit will be required.

(2) The permitted system shall be constructed and operated according to the specifications and conditions of the permit and in compliance with this regulation.

(3) Permits issued after the effective date of this regulation shall remain valid for a period of five (5) years from the date of issuance, provided the physical character of the property has not changed and the conditions of the original permit can be met. Exceptions may be granted for those permits addressed by other statutes.

104.3. Final Inspections and Approval.

(1) Except in the case of systems designed by a Registered Professional Engineer, all installers shall arrange with the Department in advance a time for a final inspection of an onsite wastewater system that is being installed. It shall be considered a violation of this regulation to cover a system that has not been subject to final Department inspection or installer self-inspection in accordance with this regulation.

(2) Final inspections of onsite wastewater systems to determine compliance with a Department-issued permit to construct shall be conducted by certified Department staff except as follows:

(a) Registered Professional Engineers licensed in South Carolina must conduct final inspections on all systems they design.

(b) Except as provided in 104.3(2)(a), Tier 3 installers may self-inspect systems they install. Tier 3 installers shall comply with Section 702.2 in its entirety.

(c) Except as provided in Section 104.3(2)(a), the Department may, in its discretion, direct Tier 1 and Tier 2 installers with no pending enforcement actions or prior Department findings of violation under Section 800 of this regulation to self-inspect systems they have installed using a process and form directed by the Department. Tier 1 and Tier 2 installers allowed to conduct self-inspections shall comply with Section 702.2 in its entirety. The Department reserves the right to withdraw any direction to Tier 1 and Tier 2 installers to conduct self-inspections at any time.

(3) Documentation of system installations, including certified as-built plans where required, shall be submitted in a Department-approved format within two (2) business days of completing the system installation or within two (2) business days of the installer self-inspection, where applicable.

(4) The licensed system installer shall also sign a statement certifying that the onsite wastewater system was installed as specified in the Department issued permit.

(5) Following final inspection and upon review of all required documentation, the Department will issue an approval to operate for a system installed in compliance with the issued permit to construct and all applicable requirements of this regulation. The Department will not issue an approval to operate if it determines that the system installation is inconsistent with the issued permit to construct or inconsistent with any requirement of this regulation.

104.4. Variances and Exemptions.

(1) The Department may, on a case-by-case basis, approve and issue a variance or exemption from one or more requirements of this regulation upon a finding that:

(a) The granting of the variance or exemption will not compromise protection to human health and the environment.

(b) Because of the characteristics of the site, it is not practical or feasible for the onsite wastewater system to meet the requirements of this regulation without taking into account the current science and best technology available.

(2) A request for variance or exemption must be in writing and include the following:

(a) A detailed description of the regulatory requirements for which the variance or exemption is sought.

(b) Sufficient data to demonstrate to the satisfaction of the Department that compliance with the regulatory requirement will not be practical or feasible.

(3) The Department may request additional information to evaluate the request. A complete variance request will be processed within three (3) business days of receiving the request. If approved, the variance or exemption will be issued in writing and may contain conditions. The Department may revoke issued variances as it deems appropriate to protect human health and the environment.

HISTORY: Amended by State Register Volume 40, Issue No. 5, Doc. No. 4591, eff May 27, 2016. Renumbered from 61-56.103 and amended by SCSR 45-5 Doc. No. 4979, eff May 28, 2021. Amended by SCSR 46-5 Doc. No. 5103, eff May 27, 2022.

200. Minimum Site Conditions for Onsite Wastewater Systems.

200.1. Soil texture, depth of soil to restrictive horizons, and depth to the zone of saturation shall meet minimum standards approved by the Department. These characteristics shall be determined using accepted methodologies in the field of soil science.

200.2. Soils exhibiting massive or platy structure, and soils which have been identified as having substantial amounts of expansible layer clay minerals or smectites, are unsuitable for onsite wastewater systems.

200.3. Where the estimated peak sewage flow will not exceed fifteen hundred (1500) gpd, the minimum vertical separation between the deepest point of effluent application and the zone of saturation shall be at least six (6) inches.

200.4. Where the estimated peak sewage flow will exceed fifteen hundred (1500) gpd, the depth to the zone of saturation shall be at least thirty-six (36) inches below the naturally occurring soil surface, and at least six (6) inches below the deepest point of effluent application.

200.5. Depth to rock and other restrictive horizons shall be greater than twelve (12) inches below the deepest point of effluent application.

200.6. Setbacks.

(1) The area of the lot or plot of ground where the onsite wastewater system is to be installed shall be of sufficient size so that no part of the system, excluding solid pipes, will be:

(a) Within five (5) linear feet of a building, or under a driveway or parking area;

(b) Within seventy-five (75) linear feet of a private well;

(c) Within one hundred (100) linear feet of a public well;

(d) Within seventy-five (75) linear feet of the delineated critical area line (tidal waters of coastal waters and tidelands critical areas) as determined by the Department's coastal division; or within seventy-five (75) linear feet of the mean high water (within the banks) elevation (nontidal waters, beach/dune systems and beach critical areas) of an impounded or natural body of water, including streams, canals, and retention ponds;

(e) Within ten (10) feet of upslope and twenty-five (25) feet of downslope curtain drains;

(f) Within twenty-five (25) feet of a drainage ditch or stormwater treatment system including any detention ponds (determined by maximum water elevation);

(g) Within fifteen (15) feet of piped drainage ditches;

(h) Within fifteen (15) feet of an inground pool;

(i) Within twenty-five (25) feet upslope of a basement; and within fifteen (15) feet of the sides of a basement, except that if foundation drains are present and the elevation of the foundation drain is at the same elevation or lower than the elevation of the trench bottom for the subsurface wastewater infiltration area or repair area, then a twenty-five (25) foot setback from the sides of a basement applies. These setbacks do not apply to a septic tank/pump chamber location or where trench installations are downslope of a basement;

(j) Within fifteen (15) feet of the top of the slope of embankments or cuts of two (2) feet or more vertical height when any part of the wastewater infiltration trench is to be placed higher in elevation than the invert of the cut or embankment;

(k) Within five (5) feet of a property line.

(2) Greater protective offsets shall be required when utilizing certain system standards contained within this regulation.

(3) Prior to permitting the onsite wastewater system, jurisdictional determination of any affected wetlands may be required. Should any part of the proposed onsite wastewater system be located in wetlands, approval from the appropriate permitting agency(s) (e.g., U.S. Army Corps of Engineers, SCDHEC Ocean and Coastal Resource Management, etc.) shall be received, and proof of such provided to the Department.

200.7. In addition to the minimum space required in Section 200.6, minimum repair area shall be set aside as follows:

(1) Any new site meeting the minimum design criteria for an onsite wastewater system shall have a usable repair or replacement area equivalent to at least fifty (50) percent of the size of the original system. Where community onsite wastewater systems are utilized, there must be at least one hundred (100) percent repair or replacement area.

(2) Usable repair or replacement area shall be demonstrated to include suitable soil conditions, and shall be free of impervious materials, buildings, or other improvements, setbacks, easements, and other encroachments that would prevent system construction. The undisturbed area between the wastewater infiltration trenches shall not be credited towards this requirement.

200.8. Multiple, individually owned remote subsurface wastewater infiltration areas may be considered for mass installation in a defined area where the wastewater infiltration trenches will be adjacently located to each other, provided that the combined peak wastewater loading is less than fifteen hundred (1500) gpd. In such cases, each subsurface wastewater infiltration area plot shall be sized such that there is sufficient area for one hundred (100) percent subsurface wastewater infiltration area replacement. Each plot shall be deeded, with all appropriate easements, as a lot in conjunction with the specific unit that it serves, and required protective offsets, as described in Section 200.6, shall apply to each individual remote subsurface wastewater infiltration area. A plan shall be prepared by a Registered Professional Engineer licensed in South Carolina that illustrates the overall plan; specifies the route and identification of effluent sewers and/or force mains; specifies the entity responsible for perpetual maintenance of the sewer lines and mass subsurface wastewater infiltration area; specifies the configuration and identification of the individual subsurface wastewater infiltration area parcels; and specifies the manner in which ingress and egress will be provided to the individual subsurface wastewater infiltration area parcels. When the combined peak wastewater loading of the adjacently loading subsurface wastewater infiltration area will exceed fifteen hundred (1500) gpd, the project shall

be considered as a public (community) collection and treatment system, and the onsite wastewater system must comply with the requirements in Section 103.1(5).

HISTORY: Amended by State Register Volume 40, Issue No. 5, Doc. No. 4591, eff May 27, 2016; SCSR 45-5 Doc. No. 4979, eff May 28, 2021.

201. Minimum Requirements for Onsite Wastewater System Primary Treatment.

201.1. Septic Tanks.

(1) All persons or firms manufacturing septic tanks for use in South Carolina shall submit detailed plans for each size tank to the Department and shall receive written approval for such tanks prior to their installation in the state.

(2) The design and construction of each septic tank shall be in accordance with minimum standards contained within this regulation.

(3) No septic tank shall be installed which has a net liquid capacity of less than one thousand (1000) gallons. Such tanks shall be sufficient to serve dwellings of four (4) bedrooms or less. Two hundred fifty (250) gallons additional capacity shall be required for each bedroom over four (4).

(4) When multiple dwellings share a common onsite wastewater system, each dwelling unit shall either have its own properly sized septic tank or it must discharge to a larger tank(s) that provides the combined total of the minimum septic tank capacities required for each contributing unit. Exception may be granted when a public entity, or private entity with financial assurances, is approved by the Department to provide operation and maintenance of the system. In such cases, the formula in Section 201.1(5) may be considered.

(5) Septic tanks serving establishments other than individual dwellings shall be sized according to actual peak flow data, when available, or by estimates of peak sewage flow, as set forth in standards established by the Department. For those septic tanks receiving peak flows less than fifteen hundred (1500) gpd, the net liquid capacity shall be calculated by multiplying 1.5 times the peak flow expressed in (gpd). For those septic tanks receiving peak flows between fifteen hundred (1500) and forty-five hundred (4500) gpd, the net liquid capacity shall be calculated as follows:

$$\text{Volume (V)} = 1125 \text{ gal. plus } (0.75 \times \text{Peak Flow(gpd)}).$$

For those septic tanks receiving peak flows in excess of forty-five hundred (4500) gpd, the net liquid capacity shall be at least equal to the peak flow:

$$\text{Volume (V)} = \text{Peak Flow (gpd)}$$

(6) The minimum liquid capacity requirements shall be met by the use of a single septic tank or two (2) or more tanks installed in series. Septic tanks joined in series shall be interconnected by an upper effluent pipe(s) with a minimum diameter of four (4) inches and a lower sludge pipe(s) with a minimum diameter of twelve (12) inches. The upper connection(s) shall be installed level from tank to tank, and the lower sludge pipe connection(s) shall be installed level and shall be placed twelve (12) inches above the bottoms of the tanks. The lower sludge pipe connection(s) can be eliminated if the first tank in series contains at least two-thirds (2/3) of the total required liquid capacity. There shall be no more than two (2) inches of fall from the inlet invert of the first tank to the outlet invert of the last tank in series.

201.2. Grease Traps.

(1) Any new food service facilities permitted under R.61-25, Retail Food Establishments, and served by an onsite wastewater system that is permitted after the effective date of this regulation shall be required to have a properly sized grease trap. This requirement may also apply to new facilities not requiring a food service permit under R.61-25. Exception may be granted in cases where a permitted retail food service establishment performs limited food preparation and/or cooking.

(2) Any existing food service establishment that does not have a grease trap, but experiences an onsite wastewater malfunction as a result of grease accumulation, shall be required to immediately comply with all portions of Section 201 as if it were a new food service facility.

(3) Any food service facility requiring a grease trap shall provide two (2) separate plumbing stub-outs, one serving the food preparation area and the other serving the restrooms. The stub-out from the restrooms shall discharge directly into the main building septic tank. The stub-out from the food preparation area shall discharge directly into the grease trap with the effluent then directed to the

main building septic tank. In order to enhance grease separation while the liquids are hot, the grease trap shall be placed as close as possible to the source of wastewater. Garbage grinders shall not be allowed to discharge to such systems.

(4) All grease traps must be directly accessible from the surface and must be equipped with an extended outlet sanitary tee terminating six (6) to twelve (12) inches above the tank bottom. The minimum access opening shall be eighteen (18) inches in diameter.

(5) All grease traps serving facilities from which the peak sewage flow exceeds fifteen hundred (1500) gpd shall either be dual chambered or individual tanks in series. If dual chambered, both the dividing wall and the second chamber must be equipped with a sanitary tee terminating six (6) to twelve (12) inches above the tank bottom.

(6) It shall be the responsibility of the owner/manager to ensure that the grease trap(s) is cleaned by a licensed septage pumper at frequent intervals to prevent the carryover of grease into other parts of the onsite wastewater system.

(7) Determination of Minimum Net Liquid Capacity

(a) No grease trap used as part of an onsite wastewater system shall have a net liquid capacity of less than one thousand (1000) gallons. Commercial interior-type grease interceptors shall not be utilized in lieu of a properly sized exterior grease trap.

(b) Minimum net liquid capacities of grease traps shall be determined as follows:

$NLC = GPD \times LF \times RF$, where

NLC = Net Liquid Capacity of Grease Trap (gallons)

GPD = Total Maximum Estimated Sewage Flow (gpd)

LF = Loading Factor (the approximate portion of the total maximum daily flow generated in food preparation areas)

0.3 - Schools and Other Institutions

0.4 - Restaurants

0.5 - Retail Food Stores

RF = Minimum Retention and Storage Factor of 2.5 for Onsite Wastewater Systems

201.3. Other Primary Treatment Methods.

The Department, at its discretion, may consider other methods of primary treatment requested by a Registered Professional Engineer where conditions are warranted.

HISTORY: Amended by SCSR 45-5 Doc. No. 4979, eff May 28, 2021.

202. Minimum Requirements for Onsite Wastewater System Final Treatment and Disposal Systems.

(1) All pipe utilized in onsite wastewater systems shall meet applicable ASTM standards. All piping utilized in the connection of a septic tank to a subsurface wastewater infiltration area, including that which is utilized in the connection of adjacent wastewater infiltration trenches, whether they be level or serially fed, shall be non-perforated Schedule 40 PVC pipe. Such pipe, excluding force mains, shall be a minimum of three (3) inches in diameter. The connecting pipe shall not be surrounded by aggregate.

(2) At least seven (7) feet of undisturbed earth shall exist between wastewater infiltration trenches.

(3) The aggregate used in onsite wastewater systems shall be a material approved by the Department and shall range in size from one-half (1/2) inch to two and one-half (2 1/2) inches. Fines shall be prohibited. Tire chips shall range in size from one-half (1/2) inch to four (4) inches in size, and wire strands shall not protrude more than one-half (1/2) inch from the sides.

(4) Drop boxes shall be utilized when deemed necessary by the Department. When required, they shall be surrounded and stabilized by at least two (2) feet of undisturbed or manually compacted earth, and the wastewater infiltration trenches shall be fed with non-perforated Schedule 40 PVC pipe. The invert of the drop box overflow pipe shall be at the same elevation as the top of the aggregate in the trenches fed by that box, and the top of the aggregate shall be level throughout the trench run. Other methods that affect serial distribution shall also overflow at the same elevation as the top of the aggregate.

(5) There shall be at least two (2) feet of earthen buffer between the septic tank and all portions of adjacent wastewater infiltration trenches. Where gravity flow is utilized, the invert elevation of the septic tank outlet shall be at the same elevation or higher than the top of the aggregate in the highest placed wastewater infiltration trench.

(6) To ensure proper operation and protection of onsite wastewater systems, the Department may require individual or combined installation of drainage swales, curtain or interceptor drains, protective barriers, or protective ground cover. Final approval of the permit may be withheld until such time as these improvements are completed.

(7) The bottom of each wastewater infiltration trench, including the distribution pipe contained within, shall be as level as possible, with an elevation differential not to exceed two (2) inches throughout the trench run.

(8) The required number, length, and configuration of wastewater infiltration trenches shall be determined by the Department and shall be based upon the Standard for Determining Peak Sewage Flow Rates (Section 501, Peak Sewage Flow Rate Standard) from Commercial and Recreational Establishments in conjunction with the Long-Term Acceptance Rate Standard for Onsite Wastewater Systems (Section 500, Long-Term Acceptance Rate Standard for Onsite Wastewater Systems). All systems shall be sized based upon the most hydraulically limiting, naturally occurring soil texture from the ground surface to twelve (12) inches below the bottom of the proposed wastewater infiltration trenches.

(9) The aggregate over the distribution pipe shall be covered with a strong, untreated pervious material to prevent infiltration of backfill material.

HISTORY: Amended by SCSR 45-5 Doc. No. 4979, eff May 28, 2021.

203. Onsite Wastewater System Construction Criteria.

203.1. On sloping terrain, wastewater infiltration trenches shall be installed perpendicular to the direction of slope and parallel to the contours of the land.

203.2. Where deemed necessary by the Department, all required site alterations (swales, fill, shaping, etc.) shall be done prior to permitting the installation of the onsite wastewater system.

203.3. The area in which the onsite wastewater system is to be located shall be protected from surface water and roof or downspout drainage by the installation of drainage swales and small amounts of fill to achieve positive surface drainage.

203.4. Gross amounts of dirt, mud, and debris shall be removed from the septic tank before backfilling. All backfilling around the tank shall be tamped to facilitate stabilization.

203.5. If septic tank lids are of multi-part, slab-type construction, all joints shall be caulked or covered with heavy roofing paper or similar material.

203.6. All septic tanks of two-piece construction joined by tongue and groove shall be sealed with either bituminous mastic or other watertight caulking material placed in the groove in such quantity that the sealant is clearly visible around the entire tank after the two (2) pieces are joined.

203.7. When effluent pumping is required, all components of the pumping system shall adhere to standards contained within this regulation.

203.8. The Department may restrict, delay, or prohibit the installation or final approval of any onsite wastewater system when adverse soil or site conditions exist. These may include, but not be limited to, wet soil conditions in textural Class III and Class IV as described in the Long-Term Acceptance Rate Standard for Onsite Wastewater Systems approved by the Department.

HISTORY: Amended by SCSR 45-5 Doc. No. 4979, eff May 28, 2021.

204. Evaluation of Alternative Infiltration Trench Products.

The Department shall be responsible for the evaluation and approval of alternative infiltration trench products prior to their use in the state, unless otherwise regulated by statute. This evaluation shall include a review of available research data; a review of parameters relating to structure, geometry, and volume; and the establishment of required equivalency values for comparing the product to a conventional wastewater infiltration trench.

204.1. Application.

(1) All requests for approval of alternative infiltration trench products must be submitted in writing to the Department and must include the following:

- (a) Complete description of the product and its intended use.
- (b) Complete listing of materials used in the construction of the product, including specifications.
- (c) Copies of all available literature pertaining to the product and a listing of all appropriate reference materials.
- (d) Copies of any and all available research, testing, and monitoring data, to include records of performance and/or prior experience in actual field conditions.

(2) The Department will review the application and may seek other information, including additional evaluations.

204.2. Equivalency Value for Infiltrative Surface.

(1) The total infiltrative surface area surrounding the sides and bottom of a conventional wastewater infiltration trench (i.e., 5.33 sq.ft./lin.ft.) shall serve as the basis for all geometric comparisons to alternative infiltration trench products.

(2) The effective infiltrative surface area of a conventional trench shall include the total of both rectangular sidewalls, beginning at the top of the aggregate and extending to the trench bottom, in addition to the width of the trench bottom. Similarly, the effective infiltrative surface area of a product shall include the total of both immediately adjacent, rectangular sidewalls, beginning at the top of louvers, slits, holes or similar orifices, in addition to the rectangular width of the trench immediately beneath the product.

(3) The equivalency value (E) for any given product is determined by comparing the total effective surface area of the product, as defined above, with that of a conventional wastewater infiltration trench as follows:

(a) Total Infiltrative Surface Area for One (1) Foot of Conventional Trench:

$$\text{Trench Sidewalls} = 2 \times (1.16\text{ft.H} \times 1.0 \text{ft.L}) = 2.33 \text{ sq.ft./lin.ft.}$$

$$\text{Trench Bottom} = 1 \times (3\text{ft.W} \times 1\text{ft.L}) = 3.0 \text{ sq.ft./lin.ft.}$$

$$\text{Total Infiltrative Surface Area} = 5.33 \text{ sq.ft./lin.ft.}$$

(b) Equivalency Value (E) Shall Be Computed As Follows:

$$E = 5.33 \text{ sq.ft./ft Sum of Three Rectangular Interfaces Immediately Adjacent to Product (sq.ft./ft.)}$$

(c) The Required Total Length of the Product Shall Be Calculated As Follows:

$$\text{Length of Product (L)} = E \times \text{Length of Conventional 36 in. Wide Trenches Required by DHEC Regulations and Standards}$$

204.3. Other parameters to be evaluated for alternative infiltration trench products may include the following:

(1) Structural Integrity - Products must be of sound construction and able to adequately withstand the normal pressures and stresses associated with installation and use.

(2) Inertness - No product can be approved unless it will remain relatively unaffected for extended periods of time while in contact with typical domestic wastewater.

(3) Storage Volume - The effluent storage capacity of a product must closely approximate or exceed that of a comparable conventional system.

(4) Maintenance of Permeable Interfaces - A product shall have a direct interface with the effective infiltrative surface (undisturbed natural soil) or, if backfill is required, backfill material shall not create a permeability barrier and shall not hinder the downward or horizontal flow of effluent into the undisturbed natural soil.

(5) The unique characteristics of a given product may warrant the evaluation of other parameters not specifically mentioned in this section of the regulation.

(6) The design, construction, or installation methods used with any product shall not conflict nor violate any other requirements established by the Department.

204.4. Approval for General Use.

If warranted, the Department will issue a letter of approval for general use of the alternative infiltration trench product in accordance with equivalency values and other requirements determined herein. At least nine (9) inches of soil cover is required.

HISTORY: Amended by State Register Volume 40, Issue No. 5, Doc. No. 4591, eff May 27, 2016; SCSR 45-5 Doc. No. 4979, eff May 28, 2021.

300. Wastewater Treatment Facility Accessibility.

300.1. Permits for new onsite wastewater systems shall not be issued where a wastewater treatment facility is accessible for connection.

300.2. Repairs to or replacement of failing onsite wastewater systems shall not be allowed where a wastewater treatment facility is accessible for connection.

HISTORY: Amended by SCSR 45-5 Doc. No. 4979, eff May 28, 2021.

301. Discharge of Waste.

No septic tank effluent or domestic wastewater or sewage shall be discharged to the surface of the ground or into any stream or body of water in South Carolina without an appropriate permit from the Department.

HISTORY: Amended by SCSR 45-5 Doc. No. 4979, eff May 28, 2021.

302. Changes in Use That Impact Existing Onsite Wastewater Systems.

If the use of a dwelling or facility is changed such that additions or alterations are proposed which increase wastewater flow, change wastewater characteristics, or compromise the integrity or function of the system, the onsite wastewater system shall be brought into full compliance with this regulation. Alterations that change the wastewater characteristics or increase wastewater flow will require the owner to submit an application and receive a permit to construct for the upgrade/expansion prior to any alterations.

HISTORY: Renumbered from 61-56.304 and amended by SCSR 45-5 Doc. No. 4979, eff May 28, 2021.

303. Repealed.

HISTORY: Former Regulation, titled Repeal and Date of Effect, repealed by SCSR 45-5 Doc. No. 4979, eff May 28, 2021.

304. Transferred.

HISTORY: Former Regulation, titled Changes in Use That Impact Existing Onsite Wastewater Systems, transferred by SCSR 45-5 Doc. No. 4979, eff May 28, 2021. See, now S.C. CODE REGS. 61-56.302.

305. Repealed.

HISTORY: Former Regulation, titled Severability Clause, repealed by SCSR 45-5 Doc. No. 4979, eff May 28, 2021.

400

APPENDICES OF STANDARDS FOR PERMITTED SYSTEMS

Appendix A. System Standard 100/101 - Conventional with 14-Inch Aggregate Depth

(1) Site/Permitting Requirements

(a) The depth to the zone of saturation (ZOS) must be at least twenty-nine (29) inches below the naturally occurring soil surface and at least six (6) inches below the bottom of the proposed wastewater infiltration trenches at the deepest point of effluent application.

(b) The depth to any restrictive horizon must be greater than twelve (12) inches below the bottom of the proposed wastewater infiltration trenches at the deepest point of effluent application.

(c) The long-term acceptance rate for system sizing shall be based upon the most hydraulically limiting naturally occurring soil texture from the ground surface to twelve (12) inches below the bottom of the proposed wastewater infiltration trenches.

(d) There shall be a replacement area equivalent to at least fifty (50) percent in size of the original system area held in reserve for system repair. This area shall have a suitable configuration and shall meet the minimum soil and site conditions of this regulation.

(e) This system must not be used on sloping sites that require serial distribution unless it can be demonstrated that the entire wastewater infiltration trench installation (i.e., side wall to side wall and end to end) can meet the required textural limitations and the required offsets to the zone of saturation and restrictive horizons.

(2) Installation Requirements

(a) The wastewater infiltration trench aggregate shall be fourteen (14) inches in depth and shall be placed so as to provide seven (7) inches of aggregate below the pipe, four (4) inches beside the pipe, and three (3) inches above the pipe. The aggregate shall be covered with at least nine (9) inches of soil.

(b) The wastewater infiltration trench width shall be thirty-six (36) inches.

(c) Where gravity flow from the septic tank to the subsurface wastewater infiltration area is utilized, the invert elevation of the septic tank outlet shall be installed at an elevation at least equal to or higher than the top of the aggregate in the highest wastewater infiltration trench(es).

(d) All tree and brush removal shall be done in a manner that minimizes the disturbance or loss of naturally occurring soil.

(3) Final Landscaping and Drainage

(a) Installation of drainage swales, ditches, curtain drains, and rain gutters may be required to divert or intercept water away from the onsite wastewater system location to a positive outfall. The septic tank and subsurface wastewater infiltration area shall be backfilled and shaped to promote surface water runoff.

(b) A barrier to preclude parking and vehicular traffic over the system area may be required.

(c) Following final landscaping, seeding, or sodding may be required to prevent erosion.

(d) Final approval shall be withheld until all landscaping and drainage improvements have been satisfactorily completed.

SOUTH CAROLINA DEPARTMENT OF HEALTH AND ENVIRONMENTAL CONTROL
BUREAU OF ENVIRONMENTAL HEALTH SERVICES

CONVENTIONAL SYSTEM
WITH FOURTEEN (14) INCH AGGREGATE DEPTH

PROGRAM 360 / CODE 100 / CODE 101 IF PUMPED

TYPICAL DESIGN ILLUSTRATION

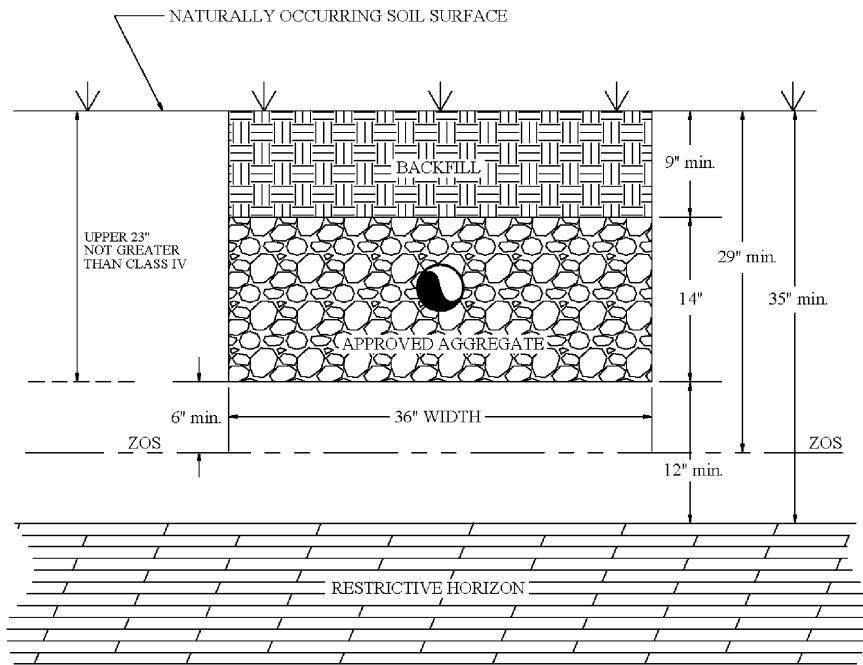

Rev. 10/19/2020

HISTORY: Added by SCSR 45-5 Doc. No. 4979, eff May 28, 2021.

Appendix B. System Standard 150 - Large (greater than 1500 gpd) and Community Systems

(1) Site/Permitting Requirements

(a) Designs for large and community onsite wastewater systems shall be prepared by a Registered Professional Engineer licensed in South Carolina. Further, the Department may require whatever engineering and soils based submittals are deemed necessary to determine the feasibility and acceptability of any site for such a system.

(b) No part of the system, with the exception of solid pipe, may be located within one hundred (100) linear feet of a receptor.

(c) The depth to the zone of saturation (ZOS) shall be at least thirty-six (36) inches below the naturally occurring soil surface and at least six (6) inches below the deepest point of effluent application.

(d) The depth to any restrictive horizon must be greater than twelve (12) inches below the bottom of the proposed wastewater infiltration trenches.

(e) The long-term acceptance rate for system sizing shall be based upon the most hydraulically limiting, naturally occurring soil texture from the ground surface to twelve (12) inches below the bottom of the proposed wastewater infiltration trenches.

(f) There shall be at least fifty (50) percent reserved subsurface wastewater infiltration area repair or replacement area available consisting of soils suitable for a large onsite wastewater system, except where public (community) systems are utilized, in which case there must be at least one hundred (100) percent repair or replacement area.

(g) Large (greater than 1500 gpd) and community onsite wastewater systems incorporating advanced treatment methods, including but not limited to aerobic pre-treatment, lagoons, surface or subsurface drip irrigation, low pressure pipe distribution, and other maintenance intensive methods, shall be required to obtain a Land Application Permit under R.61-9.505.

(h) Efforts to circumvent the requirements of this standard by configuring remote, individually deeded, adjacently located subsurface wastewater infiltration areas in lieu of a community onsite wastewater system shall not be permitted. On a very limited basis, a few of these individual systems may be considered for mass installation where the wastewater infiltration trenches will be adjacent to each other in a defined area, provided that the combined peak wastewater loading is less than fifteen hundred (1500) gpd. In such cases:

(i) Each subsurface wastewater infiltration area plot shall be sized such that there is sufficient area for one hundred (100) percent subsurface wastewater infiltration area replacement.

(ii) Each plot shall be deeded with all appropriate easements as a lot in conjunction with the specific unit that it serves, and required protective offsets, as described in Section 200.6, shall apply to each individual remote subsurface wastewater infiltration area.

(iii) A plan shall be prepared by a Registered Professional Engineer licensed in South Carolina that illustrates the overall plan; specifies the route and identification of effluent sewers and force mains; specifies the entity responsible for perpetual maintenance of the sewer lines and mass subsurface wastewater infiltration area; specifies the configuration and identification of the individual subsurface wastewater infiltration area parcels; and specifies the manner in which ingress and egress will be provided to the individual subsurface wastewater infiltration area parcels.

(iv) When the combined peak wastewater loading of the adjacently located subsurface wastewater infiltration areas from the entire project will exceed fifteen hundred (1500) gpd, the project shall be considered as a public (community) collection and treatment system, and all requirements described in Section 103.1(5) and this standard shall apply.

(2) Installation Requirements

(a) Large (greater than 1500 gpd) and community onsite wastewater systems shall not be constructed in fill material and shall not be placed any closer to receptors than one hundred (100) feet.

(b) Conventional wastewater infiltration trenches installed in the naturally occurring soil and having a width of thirty-six (36) inches shall be utilized.

(c) Wherever possible, designs that favor long wastewater infiltration trenches, convex landscape positions, and rectangular subsurface wastewater infiltration area configurations shall be required.

(d) All tree/brush removal shall be done in a manner that minimizes the disturbance or loss of naturally occurring soil.

(3) Community or Cluster Collection and Treatment Onsite Wastewater Systems

(a) An onsite wastewater system serving more than one (1) piece of deeded property shall be considered as a public (community) collection and treatment system.

(b) A permit activity will not occur that is inconsistent with a plan or plan amendment approved under Section 208(b) of the Clean Water Act, unless the Department finds such variance necessary to protect the public's health, safety, and welfare.

(c) A public entity shall own the system and shall be responsible for the operation, maintenance, and replacement of all components unless otherwise approved by the Department. The Department may consider a request from a private entity or person; however, such proposals must be evaluated on a case-by-case basis. The Department will evaluate the capability of long-term, reliable system operation in its evaluation of a permit request.

(d) If the project is owned by a private entity or person, the Department shall require financial assurances for the operation, maintenance, and replacement of the tank(s) and subsurface wastewater infiltration area system and relevant collection/pumping components.

(e) There shall be an area equivalent to one hundred (100) percent in size of the original primary subsurface wastewater infiltration area held in reserve for system repair or replacement. This area shall have a suitable configuration and shall meet all minimum requirements for large onsite wastewater systems.

(f) The collection sewer and pumping portions of a community onsite wastewater system shall receive a separate Construction Permit under R.61-67.300.

(g) The responsible party(s) on record shall be required to properly operate and maintain in good working order all system(s) parts which are installed pursuant to the permit and to comply with all terms and conditions of the permit. System parts include, but are not limited to, sealed watertight tanks, lid(s), piping, aggregate, pump, and pump components.

HISTORY: Renumbered from 61-56.401 and amended by SCSR 45-5 Doc. No. 4979, eff May 28, 2021.

Appendix C. System Standard 210/211 - Shallow Placement with 9-Inch Aggregate Depth

(1) Site/Permitting Requirements

(a) There must not be a zone of saturation (ZOS) within twenty-four (24) inches of the naturally occurring soil surface.

(b) The depth to any restrictive horizon must be greater than twelve (12) inches below the bottom of the proposed wastewater infiltration trenches.

(c) The texture in the upper eighteen (18) inches of naturally occurring soil may either be Class I, Class II, Class III, or Class IV.

(d) The long-term acceptance rate for system sizing shall be based upon the most hydraulically limiting naturally occurring soil texture from the ground surface to twelve (12) inches below the bottom of the proposed wastewater infiltration trenches.

(e) Due to the decreased sidewall absorption area and the increased potential for ground water mounding near the surface, the Equivalency Factors for these systems shall be calculated by conventional wastewater infiltration trenches and increased by an additional factor of 0.09 times.

(f) There shall be a replacement area equivalent to at least fifty (50) percent in size of the original system area held in reserve for system repair. This area shall have a suitable configuration and shall meet the minimum soil and site conditions of this regulation.

(g) This system must not be used on sloping sites that require serial distribution unless it can be demonstrated that the entire wastewater infiltration trench installation (i.e., side wall to side wall and end to end) can meet the required textural limitations and the required offsets to the zone of saturation and restrictive horizons.

(h) This system cannot be considered for facilities with peak flow rates in excess of fifteen hundred (1500) gpd.

(2) Installation Requirements

(a) The wastewater infiltration trench aggregate shall be nine (9) inches in depth and shall be covered with at least nine (9) inches of backfill.

(b) The wastewater infiltration trench width shall be thirty-six (36) inches.

(c) The maximum depth of the bottom of the wastewater infiltration trench shall be eighteen (18) inches below the naturally occurring soil surface unless it can be demonstrated that deeper placement can meet the required textural limitations and the offsets to the zone of saturation and restrictive horizons.

(d) Where gravity flow from the septic tank to the subsurface wastewater infiltration area is utilized, the invert elevation of the septic tank outlet shall be installed at an elevation at least equal to or higher than the top of the aggregate in the highest wastewater infiltration trench(es).

(e) All tree and brush removal shall be done in a manner that minimizes the disturbance or loss of naturally occurring soil.

(3) Final Landscaping and Drainage

(a) Installation of drainage swales, ditches, curtain drains, and rain gutters may be required to divert or intercept water away from the onsite wastewater system location to a positive outfall. The septic tank and subsurface wastewater infiltration area shall be backfilled and shaped to promote surface water runoff.

(b) A barrier to preclude parking and vehicular traffic over the system area may be required.

(c) Following final landscaping, seeding or sodding may be required to prevent erosion.

(d) Final approval shall be withheld until all landscaping and drainage improvements have been satisfactorily completed.

**SOUTH CAROLINA DEPARTMENT OF HEALTH AND ENVIRONMENTAL CONTROL
BUREAU OF ENVIRONMENTAL HEALTH**

ALTERNATIVE STANDARD
SHALLOW PLACEMENT WITH NINE (9) INCH AGGREGATE DEPTH

PROGRAM 362 / CODE 210 / CODE 211 IF PUMPED

TYPICAL DESIGN ILLUSTRATION

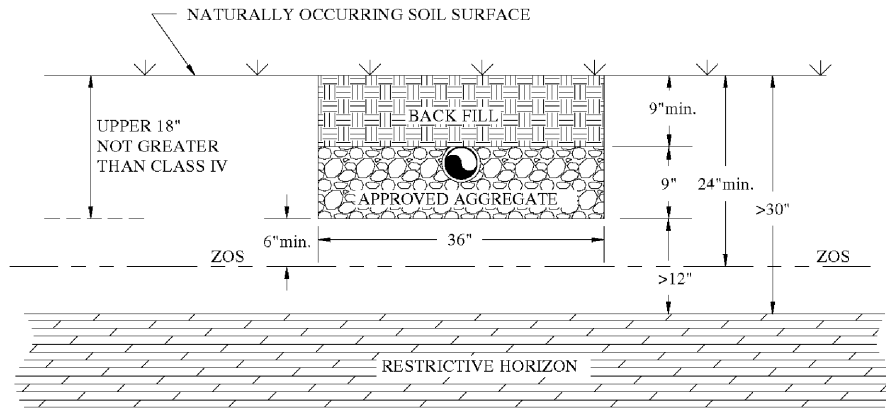

NOT TO SCALE

REV. 03/09/2018

HISTORY: Renumbered from 61-56.402 and amended by SCSR 45-5 Doc. No. 4979, eff May 28, 2021.

Editor's Note

In 2012 the correct design illustration was added.

Appendix D. System Standard 220/221 - Shallow Placement with Six (6)-Inch Aggregate Depth

(1) Site/Permitting Requirements

(a) There must not be a zone of saturation (ZOS) within twenty-one (21) inches of the naturally occurring soil surface.

(b) The depth to any restrictive horizon must be greater than twelve (12) inches below the bottom of the proposed wastewater infiltration trenches.

(c) The texture in the upper eighteen (18) inches of naturally occurring soil may either be Class I, Class II, Class III, or Class IV.

(d) The long-term acceptance rate for system sizing shall be based upon the most hydraulically limiting naturally occurring soil texture from the ground surface to twelve (12) inches below the bottom of the proposed wastewater infiltration trenches.

(e) Due to the decreased sidewall absorption area and the increased potential for ground water mounding near the surface, the Equivalency Factors for these systems shall be calculated by conventional wastewater infiltration trenches and increased by an additional factor of 0.12 times.

(f) There shall be a replacement area equivalent to at least fifty (50) percent in size of the original system area held in reserve for system repair. This area shall have a suitable configuration and shall meet the minimum soil and site conditions of this regulation.

(g) This system must not be used on sloping sites that require serial distribution unless it can be demonstrated that the entire wastewater infiltration trench installation (i.e., side wall to side wall and end to end) can meet the required textural limitations and the required offsets to the zone of saturation and restrictive horizons.

(h) This system cannot be considered for facilities with peak flow rates in excess of fifteen hundred (1500) gpd.

(2) Installation Requirements

(a) The wastewater infiltration trench aggregate shall be six (6) inches in depth and shall be covered with at least nine (9) inches of backfill.

(b) The wastewater infiltration trench width shall be thirty-six (36) inches.

(c) The maximum depth of the bottom of the wastewater infiltration trench shall be fifteen (15) inches below the naturally occurring soil surface unless it can be demonstrated that deeper placement can meet the required textural limitations and the offsets to the zone of saturation and restrictive horizons.

(d) Where gravity flow from the septic tank to the subsurface wastewater infiltration area is utilized, the invert elevation of the septic tank outlet shall be installed at an elevation at least equal to or higher than the top of the aggregate in the highest wastewater infiltration trench(es).

(e) All tree and brush removal shall be done in a manner that minimizes the disturbance or loss of naturally occurring soil.

(3) Final Landscaping and Drainage

(a) Installation of drainage swales, ditches, curtain drains, and rain gutters may be required to divert or intercept water away from the onsite wastewater system location to a positive outfall. The septic tank and subsurface wastewater infiltration area shall be backfilled and shaped to promote surface water runoff.

(b) A barrier to preclude parking and vehicular traffic over the system area may be required.

(c) Following final landscaping, seeding or sodding may be required to prevent erosion.

(d) Final approval shall be withheld until all landscaping and drainage improvements have been satisfactorily completed.

SOUTH CAROLINA DEPARTMENT OF HEALTH AND ENVIRONMENTAL CONTROL
BUREAU OF ENVIRONMENTAL HEALTH SERVICES

ALTERNATIVE STANDARD
SHALLOW PLACEMENT WITH SIX (6) INCH AGGREGATE DEPTH

PROGRAM 362 / CODE 220 / CODE 221 IF PUMPED

TYPICAL DESIGN ILLUSTRATION

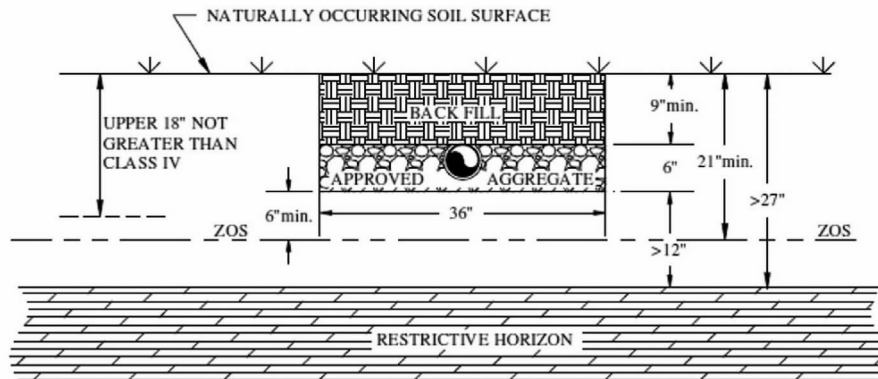

NOT TO SCALE

Rev. 03/09/18

HISTORY: Renumbered from 61-56.403 and amended by SCSR 45-5 Doc. No. 4979, eff May 28, 2021.

Editor's Note

In 2012 the correct design illustration was added.

Appendix E. System Standard 230/231 - Shallow Placement with 14-Inch Aggregate Depth with Fill Cap

(1) Site/Permitting Requirements

(a) There must not be a zone of saturation (ZOS) within twenty (20) inches of the naturally occurring soil surface.

(b) The depth to any restrictive horizon must be greater than twelve (12) inches below the bottom of the proposed wastewater infiltration trenches.

(c) The texture in the upper eighteen (18) inches of naturally occurring soil must be no more limiting than Class III.

(d) This system must not be used on sloping sites that require serial distribution unless it can be demonstrated that the entire wastewater infiltration trench installation (i.e., side wall to side wall and end to end) can meet the required textural limitations and the required offsets to the zone of saturation and restrictive horizons.

(e) The long-term acceptance rate for system sizing shall be based upon the most hydraulically limiting naturally occurring soil texture from the ground surface to twelve (12) inches below the bottom of the proposed wastewater infiltration trenches.

(f) The total linear footage of wastewater infiltration trenches shall be the same as that required for conventional systems.

(g) There shall be a replacement area equivalent to at least fifty (50) percent in size of the original system area held in reserve for system repair. This area shall have a suitable configuration and shall meet the minimum soil and site conditions of this regulation.

(h) This system cannot be considered for facilities with peak flow rates in excess of fifteen hundred (1500) gpd.

(2) Installation Requirements

(a) The wastewater infiltration trench width shall be thirty-six (36) inches.

(b) The maximum depth of the bottom of the wastewater infiltration trench shall be fourteen (14) inches below the naturally occurring soil surface unless it can be demonstrated that deeper placement can meet the required textural limitations and the offsets to the zone of saturation and restrictive horizons.

(c) The depth of the fill cap shall provide a minimum of twelve (12) inches of soil cover above the top of the wastewater infiltration trench aggregate.

(d) Where gravity flow from the septic tank to the subsurface wastewater infiltration area is utilized, the invert elevation of the septic tank outlet shall be installed at an elevation at least equal to or higher than the top of the aggregate in the highest wastewater infiltration trench(es).

(e) The required fill cap must extend at least five (5) feet beyond the limits of the subsurface wastewater infiltration trenches and must taper to the original soil surface at a slope not to exceed 10 percent. On sloping sites, where serial distribution has been incorporated into the system design, on the lower side and ends of the wastewater infiltration trenches, the fill cap must extend to at least ten (10) feet beyond the limits of the wastewater infiltration trenches and must taper to the original soil surface at a slope not to exceed five (5) percent. The required property line setback shall be measured from the point at which the fill cap taper intersects with the natural soil surface. The fill cap must be installed prior to beginning trench installation when required on the construction permit.

(f) The required fill material must be soil texture Class I, Class II, or Class III and be devoid of extraneous debris such as organic matter, building materials, etc.

(g) The wastewater infiltration trench aggregate shall be fourteen (14) inches in depth.

(h) All tree/brush removal shall be done in a manner that minimizes the disturbance or loss of naturally occurring soil.

(3) Final Landscaping and Drainage

(a) The septic tank and fill cap area shall be backfilled and shaped to promote the runoff of surface water.

(b) Where natural surface drainage does not exist, a swale shall be constructed adjacent to the fill cap area to divert surface water away from the onsite wastewater system to a positive outfall. The installation of ditches, curtain drains, and rain gutters may be required to intercept and divert water away from the onsite wastewater system location.

(c) A barrier to preclude parking and vehicular traffic over the system area may be required.

(d) Following final landscaping, seeding or sodding may be required to prevent erosion.

(e) Final approval shall be withheld until all landscaping and drainage improvements have been satisfactorily completed.

SOUTH CAROLINA DEPARTMENT OF HEALTH AND ENVIRONMENTAL CONTROL
BUREAU OF ENVIRONMENTAL HEALTH SERVICES

ALTERNATIVE STANDARD
SHALLOW PLACEMENT SYSTEM WITH FILL CAP
PROGRAM 362 / CODE 230 / CODE 231 IF PUMPED

TYPICAL DESIGN ILLUSTRATION

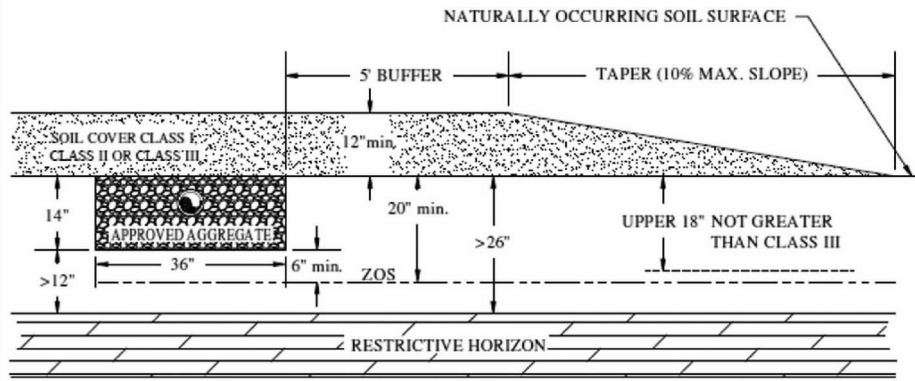

NOT TO SCALE

Rev. 03/09/18

HISTORY: Renumbered from 61-56.404 and amended by SCSR 45-5 Doc. No. 4979, eff May 28, 2021.

Appendix F. System Standard 240/241 - Ultra-Shallow Placement with 6-Inch Aggregate Depth with Fill Cap

(1) Site/Permitting Requirements

(a) There must not be a zone of saturation (ZOS) within twelve (12) inches of the naturally occurring soil surface.

(b) The depth to any restrictive horizon must be greater than twelve (12) inches below the bottom of the proposed wastewater infiltration trenches.

(c) The soil texture in the upper eighteen (18) inches of naturally occurring soil must be no more limiting than Class III.

(d) This system must not be used on sloping sites that require serial distribution unless it can be demonstrated that the entire wastewater infiltration trench installation (i.e., side wall to side wall and end to end) meets the required textural limitations and required offsets to the zone of saturation and restrictive horizons.

(e) No part of this system can be installed within one hundred twenty-five (125) feet of the critical area line or tidal waters as determined by the Department; or within one hundred twenty-five (125) feet of the ordinary high water elevation within the banks of non-tidal, environmentally sensitive waters.

(f) The long-term acceptance rate for system sizing shall be based upon the most hydraulically limiting naturally occurring soil texture from the ground surface to twelve (12) inches below the bottom of the proposed wastewater infiltration trenches.

(g) Due to the decreased sidewall area and the increased potential for ground water mounding near the surface, the Equivalency Factors for these systems shall be calculated by conventional wastewater infiltration trenches and increased by an additional factor of 0.12 times.

(h) There shall be a replacement area equivalent to at least fifty (50) percent in size of the original system area held in reserve for system repair. This area shall have a suitable configuration and shall meet the minimum soil and site conditions of this regulation.

(i) This system cannot be considered for facilities with peak flow rates in excess of fifteen hundred (1500) gpd.

(2) Installation Requirements

(a) The wastewater infiltration trench width shall be thirty-six (36) inches.

(b) The maximum depth of the bottom of the wastewater infiltration trench shall be six (6) inches below the naturally occurring soil surface unless it can be demonstrated that deeper placement can meet the required textural limitations and offsets to the zone of saturation and restrictive horizons.

(c) The depth of the fill cap shall provide a minimum of twelve (12) inches backfill above the top of the wastewater infiltration trench aggregate.

(d) Where gravity flow from the septic tank to the subsurface wastewater infiltration area is utilized, the invert elevation of the septic tank outlet shall be installed at an elevation at least equal to or higher than the top of the aggregate in the highest wastewater infiltration trench(es).

(e) The required fill cap must extend at least five (5) feet beyond the limits of the subsurface wastewater infiltration trenches and must taper to the original soil surface at a slope not to exceed 10 percent. On sloping sites where serial distribution has been incorporated into the system design, on the lower side and ends of the wastewater infiltration trenches, the fill cap must extend to at least ten (10) feet beyond the limits of the wastewater infiltration trenches and must taper to the original soil surface at a slope not to exceed five (5) percent. The required property line setback shall be measured from the point at which the fill cap taper intersects with the natural soil surface. The fill cap must be installed prior to beginning trench installation when required on the construction permit.

(f) The required fill material must be soil texture Class I, Class II, or Class III, and be devoid of extraneous debris such as organic matter, building materials, etc.

(g) The wastewater infiltration trench aggregate shall be six (6) inches in depth.

(h) All tree/brush removal shall be done in a manner that minimizes the disturbance or loss of naturally occurring soil.

(3) Final Landscaping and Drainage

(a) The septic tank and fill cap area shall be backfilled and shaped to promote the runoff of surface water.

(b) Where natural surface drainage does not exist, a swale shall be constructed adjacent to the fill cap area to divert surface water away from the onsite wastewater system to a positive outfall. The installation of ditches, curtain drains, and rain gutters may be required to intercept and divert water away from the onsite wastewater system location.

(c) A barrier to preclude parking and vehicular traffic over the system area may be required.

(d) Following final landscaping, seeding or sodding may be required to prevent erosion.

(e) Final approval shall be withheld until all landscaping and drainage improvements have been satisfactorily completed.

SOUTH CAROLINA DEPARTMENT OF HEALTH AND ENVIRONMENTAL CONTROL
BUREAU OF ENVIRONMENTAL HEALTH SERVICES

ALTERNATIVE STANDARD
ULTRA-SHALLOW PLACEMENT SYSTEM WITH FILL CAP

PROGRAM 362 / CODE 240 / CODE 241 IF PUMPED

TYPICAL DESIGN ILLUSTRATION

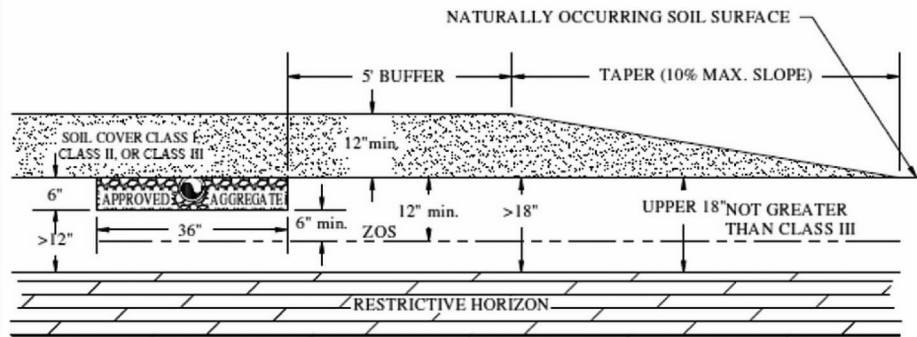

NOT TO SCALE

Rev. 03/09/18

HISTORY: Renumbered from 61-56.405 and amended by SCSR 45-5 Doc. No. 4979, eff May 28, 2021.

Appendix G. System Standard 250/251 - Reservoir Infiltration System for Soils with Expansive Clay

(1) Site/Permitting Requirements

(a) Rock formations must be greater than four (4) feet below the naturally occurring soil surface.

(b) For standard installations (see Typical Design Illustration A), the wastewater infiltration trenches must penetrate the saprolite at least six (6) inches. There must be an offset greater than twelve (12) inches between the bottom of the trenches and any rock formations. (i.e., there must be greater than eighteen (18) inches of clean, unconsolidated saprolite below the expansive clay layer.)

(c) If the unconsolidated saprolite layer is greater than sixty (60) inches below the naturally occurring soil surface (see Typical Design Illustration B), paragraph (1)(b) (above) shall apply and clean medium sand shall be added to the trenches so that the top of the aggregate will be twelve (12) inches below finished grade.

(d) There must be no evidence of a zone of saturation (ZOS) in the unconsolidated saprolite layer.

(e) The long-term acceptance rate shall not exceed 0.25 gpd/sq. ft.

(f) There shall be a replacement area equivalent to at least fifty (50) percent in size of the original system area held in reserve for system repair. This area shall have a suitable configuration and shall meet the minimum soil and site conditions of this regulation.

(g) Sites to be considered for this system shall be evaluated using backhoe pits to describe the soil profile.

(h) This system cannot be considered for facilities with peak flow rates in excess of fifteen hundred (1500) gpd.

(i) Clean, unconsolidated saprolite shall be defined as soft, friable, thoroughly decomposed rock that has formed in place by chemical weathering, retaining the fabric and structure of the parent rock, and being devoid of expansive clay. Unconsolidated saprolite can be dug using a hand auger or knife. Consolidated saprolite cannot be penetrated with a hand auger or similar tool and must be dug with a backhoe or other powered equipment.

(ii) Expansive clay shall be defined as soils containing significant amounts of expansible-layer clay minerals or smectites as evidenced in the field by classifications of Very Sticky and Very Plastic and Structure Grades of Weak or Structureless when evaluated in accordance with the Field Book. Such soils are considered to be unsuitable for onsite wastewater systems.

(2) Installation Requirements

(a) The depth of approved aggregate shall be twenty-four (24) inches.

(b) The depth of medium sand will vary between zero (0) and one hundred twenty (120) inches, depending upon the depth to the saprolite layer.

(c) The trench width shall be thirty-six (36) inches.

(d) Where gravity flow from the septic tank to the subsurface wastewater infiltration area is utilized, the invert elevation of the septic tank outlet shall be installed at an elevation at least equal to or higher than the top of the aggregate in the highest wastewater infiltration trench(es).

(e) The backfill shall range from twelve (12) inches to thirty-six (36) inches for standard installations (see Typical Design Illustration A) and shall be twelve (12) inches where the depth to saprolite is greater than sixty (60) inches below the naturally occurring soil surface (see Typical Design Illustration B).

(3) Final Landscaping and Drainage

(a) On sites where there is evidence of a zone of saturation at the soil-expansive clay interface, a curtain drain must be placed upslope along a contour and must extend the entire length of the subsurface wastewater infiltration area. The curtain drain shall extend a minimum of six (6) inches into the expansive clay layer. The septic tank and subsurface wastewater infiltration area shall be backfilled and shaped to promote surface water runoff.

(b) Following final landscaping, seeding or sodding may be required to prevent erosion.

(c) Final approval shall be withheld until all landscaping and drainage improvements have been satisfactorily completed.

**SOUTH CAROLINA DEPARTMENT OF HEALTH AND ENVIRONMENTAL CONTROL
BUREAU OF ENVIRONMENTAL HEALTH SERVICES**

ALTERNATIVE SYSTEM
RESERVOIR INFILTRATION SYSTEM FOR SOILS WITH EXPANSIVE CLAY

PROGRAM 362 / CODE 250 / CODE 251 IF PUMPED

**TYPICAL DESIGN ILLUSTRATION (A)
STANDARD INSTALLATION**

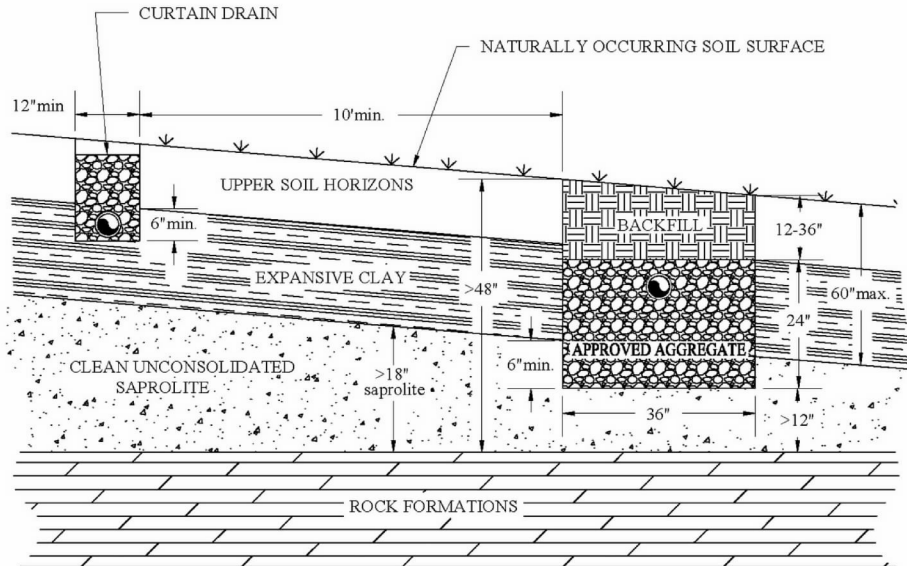

NOTE: FOR SOILS WITH THICK EXPANSIVE CLAY HORIZONS
(i.e., DEPTH TO SAPROLITE > 60 INCHES BELOW NATURALLY OCCURRING SOIL SURFACE)
SEE TYPICAL DESIGN ILLUSTRATION (B)

NOT TO SCALE
REV. 03/09/18

**SOUTH CAROLINA DEPARTMENT OF HEALTH AND ENVIRONMENTAL CONTROL
BUREAU OF ENVIRONMENTAL HEALTH SERVICES**

ALTERNATIVE SYSTEM
RESERVOIR INFILTRATION SYSTEM FOR SOILS WITH EXPANSIVE CLAY

PROGRAM 362 / CODE 250 / CODE 251 IF PUMPED

**TYPICAL DESIGN ILLUSTRATION (B)
WHERE DEPTH TO SAPROLITE > 60in. BELOW SURFACE**

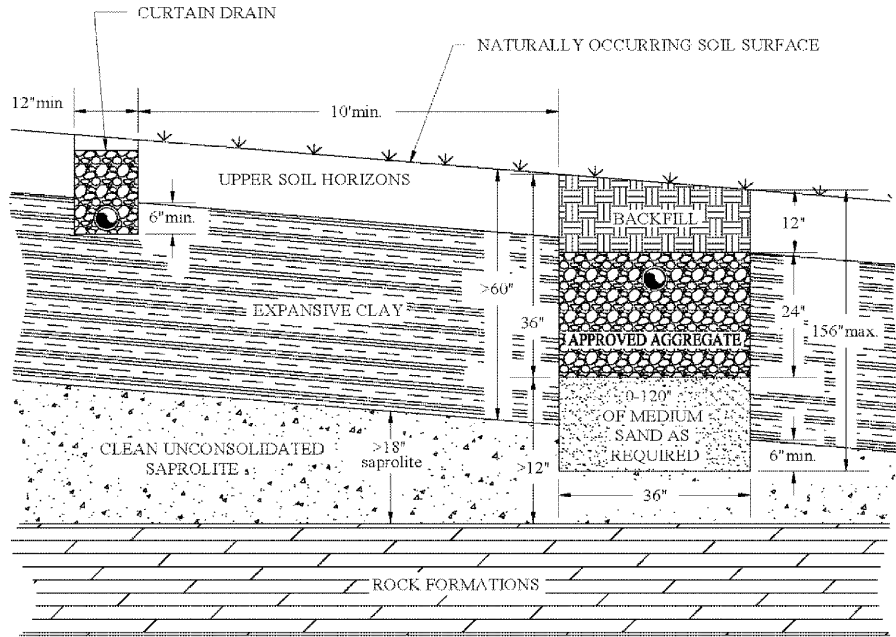

NOTE: FOR SOILS WITH THINNER EXPANSIVE CLAY HORIZONS
(i.e., DEPTH TO SAPROLITE NOT >60in. BELOW NATURALLY OCCURRING SOIL SURFACE)
SEE TYPICAL DESIGN ILLUSTRATION (A)

NOT TO SCALE
REV 03/09/18

HISTORY: Renumbered from 61-56.406 and amended by SCSR 45-5 Doc. No. 4979, eff May 28, 2021.

Appendix H. System Standard 260/261 - 9-Inch Shallow Placement System with Fill Cap

(1) Site/Permitting Requirements

(a) There must not be a zone of saturation (ZOS) within fifteen (15) inches of the naturally occurring soil surface.

(b) The depth to any restrictive horizon must be greater than twelve (12) inches below the bottom of the proposed wastewater infiltration trenches.

(c) The texture in the upper eighteen (18) inches of naturally occurring soil must be no more limiting than Class III.

(d) This system must not be used on sloping sites that require serial distribution unless it can be demonstrated that the entire wastewater infiltration trench installation (i.e., side wall to side wall and end to end) can meet the required textural limitations and the required offsets to the zone of saturation and restrictive horizons.

(e) The long-term acceptance rate for system sizing shall be based upon the most hydraulically limiting naturally occurring soil texture from the ground surface to twelve (12) inches below the bottom of the proposed wastewater infiltration trenches.

(f) Due to the decreased sidewall absorption area and the increased potential for ground water mounding near the surface, the Equivalency Factors for these systems shall be calculated by conventional wastewater infiltration trenches and increased by an additional factor of 0.09 times.

(g) No part of this system can be installed within 125 feet of the critical area line or tidal waters as determined by the Department; or within 125 feet of the ordinary high water elevation within the banks of non-tidal, environmentally sensitive waters.

(h) There shall be a replacement area equivalent to at least fifty (50) percent in size of the original system area held in reserve for system repair. This area shall have a suitable configuration and shall meet the minimum soil and site conditions of this regulation.

(i) This system cannot be considered for facilities with peak flow rates in excess of fifteen hundred (1500) gpd.

(2) Installation Requirements

(a) The wastewater infiltration trench width shall be thirty-six (36) inches.

(b) The maximum depth of the bottom of the wastewater infiltration trench shall be nine (9) inches below the naturally occurring soil surface unless it can be demonstrated that deeper placement can meet the required textural limitations and the offsets to the zone of saturation and restrictive horizons.

(c) Where gravity flow from the septic tank to the subsurface wastewater infiltration area is utilized, the invert elevation of the septic tank outlet shall be installed at an elevation at least equal to or higher than the top of the aggregate in the highest wastewater infiltration trench(es).

(d) The depth of the fill cap shall provide a minimum of twelve (12) inches backfill above the top of the wastewater infiltration trench aggregate.

(e) The required fill cap must extend at least five (5) feet beyond the limits of the wastewater infiltration trenches and must taper to the original soil surface at a slope not to exceed 10 percent (see attached illustration). On sloping sites where serial distribution has been incorporated into the system design, on the lower side and ends of the wastewater infiltration trenches, the fill cap must extend to at least ten (10) feet beyond the limits of the wastewater infiltration trenches and must taper to the original soil surface at a slope not to exceed five (5) percent. The required property line setback shall be measured from the point at which the fill cap taper intersects with the naturally occurring soil surface. The fill cap must be installed prior to beginning trench installation when required on the construction permit.

(f) The required fill material must be soil texture Class I, Class II, or Class III, and be devoid of extraneous debris such as organic matter, building materials, etc.

(g) The wastewater infiltration trench aggregate shall be nine (9) inches in depth.

(h) All trees/brush removal shall be done in a manner that minimizes the disturbance or loss of naturally occurring soil.

(3) Final Landscaping and Drainage

(a) The septic tank and fill cap area shall be backfilled and shaped to promote the runoff of surface water.

(b) Where natural surface drainage does not exist, a swale shall be constructed adjacent to the fill cap area to divert surface water away from the onsite wastewater system to a positive outfall. The

installation of ditches, curtain drains, and rain gutters may be required to intercept and divert water away from the onsite wastewater system location.

(c) A barrier to preclude parking and vehicular traffic over the system area may be required.

(d) Following final landscaping, seeding or sodding may be required to prevent erosion.

(e) Final approval shall be withheld until all landscaping and drainage improvements have been satisfactorily completed.

**SOUTH CAROLINA DEPARTMENT OF HEALTH AND ENVIRONMENTAL CONTROL
BUREAU OF ENVIRONMENTAL HEALTH SERVICES**

ALTERNATIVE STANDARD
NINE INCH SHALLOW PLACEMENT WITH FILL CAP

PROGRAM 362 / CODE 260 / CODE 261 IF PUMPED

TYPICAL DESIGN ILLUSTRATION

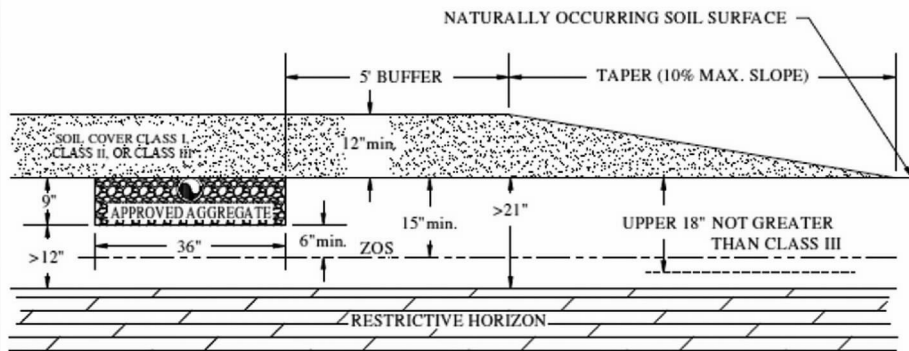

NOT TO SCALE

Rev. 03/09/18

HISTORY: Renumbered from 61-56.407 and amended by SCSR 45-5 Doc. No. 4979, eff May 28, 2021.

Appendix I. System Standard 270/271 - Alternative Trench Width and Depth Systems

(1) Site/Permitting Requirements

(a) Soil conditions, the depth to rock and other restrictive horizons, the depth to the zone of saturation (ZOS), and the elevation differential between the septic tank outlet and the highest wastewater infiltration trench(es) must meet applicable standards for conventional or alternative onsite wastewater systems.

(b) There shall be a replacement area equivalent to at least fifty (50) percent in size of the original system area held in reserve for system repair. This area shall have a suitable configuration and shall meet the minimum soil and site conditions of this regulation.

(c) This system cannot be considered for facilities with peak flow rates in excess of fifteen hundred (1500) gpd unless the trench width is three (3) feet and the aggregate depth is between fourteen (14) and twenty-eight (28) inches.

(d) The linear footage requirement for an alternative width and depth system shall be determined by first figuring the conventional (thirty-six (36) inch wide with fourteen (14) inch aggregate depth) linear footage requirements and then multiplying by the appropriate factor based on desired trench width and aggregate depth. (See table below system illustration for multiplication factors.)

(2) Installation Requirements

(a) Trench widths shall not exceed ten (10) feet.

(b) The aggregate depth shall be between six (6) inches and twenty-eight (28) inches when considering trench widths ranging from one and one-half (1 1/2) to ten (10) feet (see chart). The aggregate depth may be increased to a maximum of forty-two (42) inches, provided the trench width does not exceed thirty-six (36) inches (Note: In these cases, the equivalency formula should be utilized to determine the appropriate factor (F) when considering aggregate depths between twenty-eight (28) and forty-two (42) inches). All trenches shall be covered with at least nine (9) inches of backfill.

(c) Methods of construction which preclude vehicular compaction of the trench bottom must always be utilized.

(3) Final Landscaping and Drainage

(a) Installation of drainage swales, ditches, diversion drains, or rain gutters may be required to divert or intercept water away from the onsite wastewater system location. The septic tank and subsurface wastewater infiltration area shall be backfilled and shaped to promote surface water runoff.

(b) A barrier to preclude parking and vehicular traffic over the area of the system may be required.

(c) Following final landscaping, seeding or sodding may be required to prevent erosion.

(d) Final approval shall be withheld until all landscaping and drainage improvements have been satisfactorily completed.

**SOUTH CAROLINA DEPARTMENT OF HEALTH AND ENVIRONMENTAL CONTROL
BUREAU OF ENVIRONMENTAL HEALTH SERVICES**

ALTERNATIVE STANDARD
ALTERNATIVE TRENCH WIDTH & DEPTH SYSTEMS

PROGRAM 362 / CODE 270 / CODE 271 IF PUMPED

TYPICAL DESIGN ILLUSTRATION

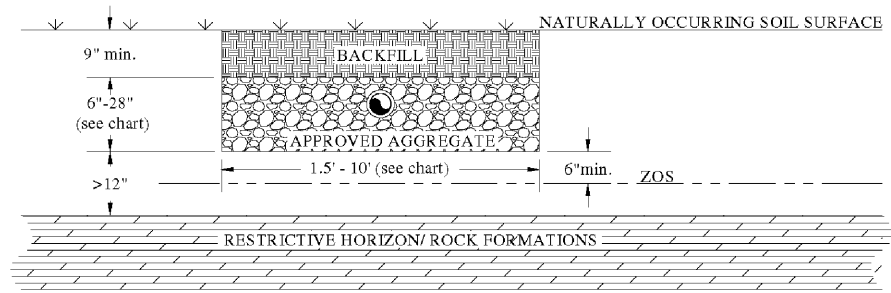

NOT TO SCALE

FACTORS (F) FOR MAINTAINING EQUIVALENT INFILTRATIVE SURFACE AREA

TRENCH WIDTH (ft.)	AGGREGATE DEPTH (in.)					
	6" *	9" **	14"	20"	24"	28"
1.5'	2.39	1.94	USE LTAR STANDARD	1.10	0.97	0.87
2.0'	1.99	1.66	USE LTAR STANDARD	1.00	0.89	0.80
2.5'	1.71	1.46	USE LTAR STANDARD	0.91	0.82	0.75
3.0'	1.50	1.30	USE LTAR STANDARD	0.84	0.76	0.70 <small>see system 360/380</small>
4.0'	1.20	1.06	0.84	0.73	0.67	0.62
5.0'	1.00	0.89	0.73	0.64	0.59	0.55
6.0'	0.85	0.78	0.64	0.57	0.53	0.50
7.0'	0.74	0.68	0.57	0.52	0.49	0.46
8.0'	0.66	0.61	0.52	0.47	0.45	0.42
9.0'	0.59	0.55	0.47	0.43	0.41	0.39
10.0'	0.54	0.51	0.43	0.40	0.38	0.36

$$F = \frac{5.33 \text{ sqft. / ft}}{2 (SwD / 12) + TW}$$

* Factors (F) reflect 12% increase
** Factors (F) reflect 9% increase
(See notes in text)

Where, 5.33 sqft/ft = total infiltrative surface area per linear foot of conventional type trench (36in. wide, 14in. deep)

SwD = Side Wall Depth (in)

TW = Trench Width (ft.)

REV. 03/09/2018

HISTORY: Renumbered from 61-56.408 and amended by SCSR 45-5 Doc. No. 4979, eff May 28, 2021.

Appendix J. System Standard 280/281 - Reservoir Infiltration System for Soils with Expansive Clay Shallow Rock Formations

(1) Site/Permitting Requirements

(a) Rock formations must be rippable to a depth greater than four (4) feet below the naturally occurring soil surface.

(b) The soil wastewater infiltration trenches must penetrate the saprolite at least six (6) inches, and there must be an offset greater than twelve (12) inches between the trench bottoms and any rock formations (i.e., there must be at least six (6) inches of clean, unconsolidated saprolite below the expansive clay layer, and medium sand may be added to the excavation to achieve an offset from rock that exceeds twelve (12) inches).

(c) There must be no evidence of a zone of saturation (ZOS) in the unconsolidated saprolite layer.

(d) The long-term acceptance rate shall not exceed 0.20-gpd/sqft.

(e) Effluent discharged to this system must receive a higher degree of treatment than that provided by a conventional septic tank (e.g., two (2) compartment septic tank or two (2) septic tanks in series).

(f) There shall be a replacement area equivalent to at least fifty (50) percent in size of the original system area held in reserve for system repair. This area shall have a suitable configuration and shall meet the minimum soil and site conditions of this regulation.

(g) No part of this system can be installed within one hundred twenty-five (125) feet of the ordinary high water elevation within the banks of environmentally sensitive waters.

(h) Sites to be considered for this system shall be evaluated using backhoe pits to describe the soil profile.

(i) This system cannot be considered for facilities with peak flow rates in excess of fifteen hundred (1500) gpd.

(i) Clean, unconsolidated saprolite shall be defined as soft, friable, thoroughly decomposed rock that has formed in place by chemical weathering, retaining the fabric and structure of the parent rock, and being devoid of expansive clay. Unconsolidated saprolite can be dug using a hand auger or knife. Consolidated saprolite cannot be penetrated with a hand auger or similar tool, and must be dug with a backhoe or other powered equipment.

(ii) Expansive clay shall be defined as soils containing significant amounts of expansible-layer clay minerals (smectites) as evidenced in the field by classifications of Very Sticky and Very Plastic and Structure Grades of Weak or Structureless when evaluated in accordance with the Field Books. Such soils are considered to be unsuitable for onsite wastewater systems.

(2) Installation Requirements

(a) The depth of approved aggregate shall be at least twenty-four (24) inches.

(b) The trench width shall be thirty-six (36) inches.

(c) Where gravity flow from the septic tank to the subsurface wastewater infiltration area is utilized, the invert elevation of the septic tank outlet shall be installed at an elevation at least equal to or higher than the top of the aggregate in the highest wastewater infiltration trench(es).

(3) Final Landscaping and Drainage

(a) On sites where there is evidence of a zone of saturation at the soil-expansive clay interface, a curtain drain must be placed upslope along a contour and must extend the entire length of the subsurface wastewater infiltration area. The curtain drain shall extend a minimum of six (6) inches into the expansive clay layer. The septic tank and subsurface wastewater infiltration area shall be backfilled and shaped to promote surface water runoff.

(b) Final approval shall be withheld until all landscaping, drainage, and other requirements have been satisfactorily completed.

(c) Following final landscaping, seeding or sodding may be required to prevent erosion.

(d) Final approval shall be withheld until all landscaping and drainage improvements have been satisfactorily completed.

**SOUTH CAROLINA DEPARTMENT OF HEALTH AND ENVIRONMENTAL CONTROL
BUREAU OF ENVIRONMENTAL HEALTH SERVICES**

**ALTERNATIVE SYSTEM
RESERVOIR INFILTRATION SYSTEM FOR SOILS WITH EXPANSIVE CLAY
OVER SHALLOW ROCK FORMATIONS**

PROGRAM 362 / CODE 280 / CODE 281 IF PUMPED

TYPICAL DESIGN ILLUSTRATION

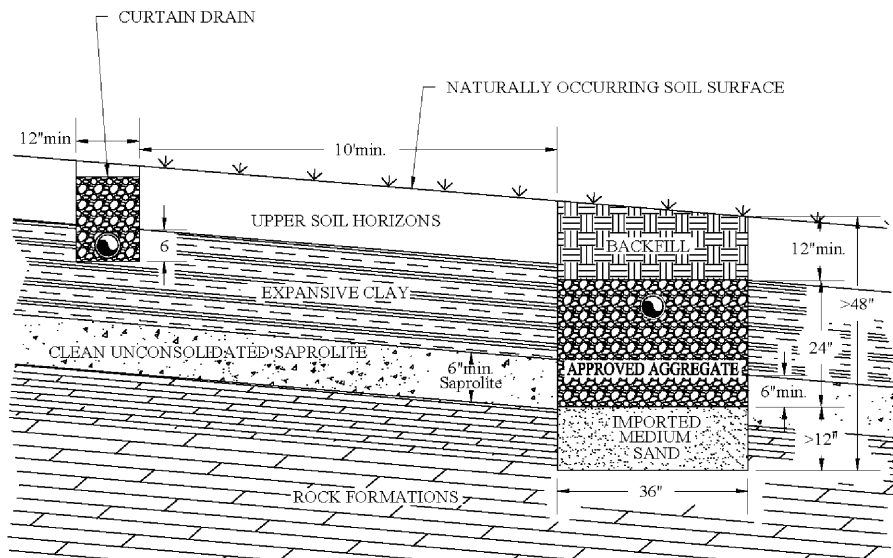

NOT TO SCALE
REV. 03/09/19

HISTORY: Renumbered from 61-56.409 and amended by SCSR 45-5 Doc. No. 4979, eff May 28, 2021.

Appendix K. System Standard 290/291 - Alternative Trench Width and Depth Systems with Fill Cap

(1) Site/Permitting Requirements

(a) The depth to any restrictive horizon must be greater than twelve (12) inches below the bottom of the proposed wastewater infiltration trenches.

(b) The texture in the upper eighteen (18) inches of naturally occurring soil must be no more limiting than Class III.

(c) Soil conditions, the depth to rock and other restrictive horizons, the depth to the zone of saturation (ZOS), and the elevation differential between the septic tank outlet and the highest wastewater infiltration trench(es) must meet applicable standards for alternative onsite wastewater systems.

(d) There shall be a replacement area equivalent to at least fifty (50) percent in size of the original system area held in reserve for system repair. This area shall have a suitable configuration and shall meet the minimum soil and site conditions of this regulation.

(e) This system cannot be considered for facilities with peak flow rates in excess of six hundred (600) gpd.

(f) The linear footage requirement for an alternative width and depth system shall be determined by first figuring the conventional (36-inch-wide with 14-inch aggregate depth) linear footage requirements and then multiplying by the appropriate factor based on desired trench width and aggregate depth as computed in the following table:

FACTOR (F) FOR MAINTAINING EQUIVALENT INFILTRATIVE SURFACE AREA			
TRENCH WIDTH (ft.)	AGGREGATE DEPTH (in.)		# OF DISTRIBUTION PIPES
	6" *	9" **	
MULTIPLICATION FACTOR			
4'	1.20	1.06	1
5'	1.00	0.89	1
6'	0.85	0.78	2
7'	0.74	0.68	2
8'	0.66	0.61	2
9'	0.59	0.55	3
10'	0.54	0.51	3

* Factors reflect a twelve (12) percent increase

** Factors reflect a nine (9) percent increase

(g) This system may only be installed on sites where the long-term acceptance rate (LTAR) for the system will be between 1.0 and 0.5 gpd per foot squared (gpd/ft²). The bottom of the absorption field cannot be installed in Class IV soils (0.4 to 0.1 LTAR).

(h) The distribution pipes in the bed shall be at least eighteen (18) inches from the edge of the trench and located on three (3) foot centers.

(i) This system must not be used on sloping sites that require serial distribution unless it can be demonstrated that the entire wastewater infiltration trench installation (i.e., side wall to side wall and end to end) can meet the required textural limitations and the required offsets to the zone of saturation and restrictive horizons.

(j) The long-term acceptance rate for system sizing shall be based upon the most hydraulically limiting naturally occurring soil texture from the ground surface to twelve (12) inches below the bottom of the proposed wastewater infiltration trenches.

(2) Installation Requirements

(a) Trench widths shall not exceed ten (10) feet.

(b) Wide trenches should be installed by excavating from the sides. Heavy equipment, such as backhoes, may not be placed in the trenches in order to avoid soil compaction.

(c) The required fill cap must extend at least five (5) feet beyond the limits of the wastewater infiltration trenches and must taper to the original soil surface at a slope not to exceed ten (10) percent. On sloping sites, where serial distribution has been incorporated into the system design, on

the lower side and ends of the wastewater infiltration trenches, the fill cap must extend to at least ten (10) feet beyond the limits of the wastewater infiltration trenches and must taper to the original soil surface at a slope not to exceed five (5) percent. The required property line setback shall be measured from the point at which the fill cap taper intersects with the naturally occurring soil surface. The fill cap must be installed prior to beginning trench installation when required on the construction permit.

(3) Final Landscaping and Drainage

(a) Installation of drainage swales, ditches, diversion drains, or rain gutters may be required to divert or intercept water away from the onsite wastewater system location. The septic tank and subsurface wastewater infiltration area shall be backfilled and shaped to promote surface water runoff.

(b) A barrier to preclude parking and vehicular traffic over the area of the system may be required.

(c) Following final landscaping, seeding, or sodding may be required to prevent erosion.

**SOUTH CAROLINA DEPARTMENT OF HEALTH AND ENVIRONMENTAL CONTROL
BUREAU OF ENVIRONMENTAL HEALTH SERVICES**

**ALTERNATIVE STANDARD
ALTERNATIVE TRENCH WIDTH & DEPTH SYSTEMS**

PROGRAM 362 / CODE 290 / CODE 291 IF PUMPED

TYPICAL DESIGN ILLUSTRATION

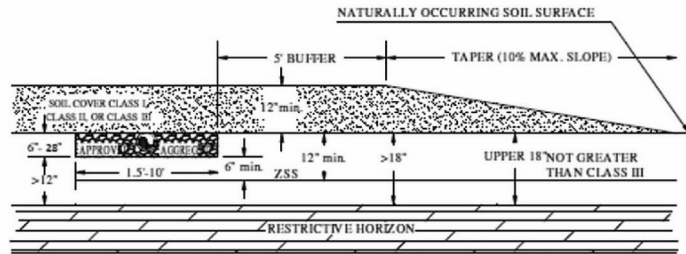

NOT TO SCALE

FACTORS (F) FOR MAINTAINING EQUIVALENT INFILTRATIVE SURFACE AREA

TRENCH WIDTH (ft.)	AGGREGATE DEPTH (in.)					
	6" *	9" **	14"	20"	24"	28"
1.5'	2.39	1.94	USE LTAR STANDARD	1.10	0.97	0.87
2.0'	1.99	1.66	USE LTAR STANDARD	1.00	0.89	0.80
2.5'	1.71	1.46	USE LTAR STANDARD	0.91	0.82	0.75
3.0'	1.50	1.30	USE LTAR STANDARD	0.84	0.76	0.70
4.0'	1.20	1.06	0.84	0.73	0.67	0.62
5.0'	1.00	0.89	0.73	0.64	0.59	0.55
6.0'	0.85	0.78	0.64	0.57	0.53	0.50
7.0'	0.74	0.68	0.57	0.52	0.49	0.46
8.0'	0.66	0.61	0.52	0.47	0.45	0.42
9.0'	0.59	0.55	0.47	0.43	0.41	0.39
10.0'	0.54	0.51	0.43	0.40	0.38	0.36

Where, 5.33 sqft/ft = total infiltrative surface area per linear foot of conventional type trench (36in. wide, 14in. deep)

$$F = \frac{5.33 \text{ sqft. / ft}}{2 (SwD / 12) + TW}$$
 * Factors (F) reflect 12% increase
 ** Factors (F) reflect 9% increase
 SwD = Side Wall Depth (in)
 TW = Trench Width (ft)
 (See notes in text) Rev. 03/09/18

HISTORY: Added by SCSR 45-5 Doc. No. 4979, eff May 28, 2021.

Appendix L. System Standard 370/371 - Shallow Placement with Fill Cap for Sites with Shallow Class IV Soil

- (1) Site/Permitting Requirements

(a) There must not be a zone of saturation (ZOS) within twelve (12) inches of the naturally occurring soil surface.

(b) The depth to any restrictive horizon must be greater than twelve (12) inches below the bottom of the proposed wastewater infiltration trenches.

(c) No part of this system can be installed within one hundred twenty-five (125) feet of the ordinary high water elevation within the banks of environmentally sensitive waters.

(d) This system may be considered for installation on contiguous lots in new subdivisions approved after the effective date of this standard provided a setback of at least seventy-five (75) feet is maintained between the system and all adjacent property lines. The seventy-five (75) foot setback shall be measured from the point at which the fill cap taper intersects with the naturally occurring soil surface.

(e) This system cannot be considered for facilities with peak sewage flow rates in excess of four hundred eighty (480) gpd. In addition, this system shall not be considered for facilities requiring grease traps.

(f) There shall be a replacement area equivalent to at least fifty (50) percent in size of the original system area held in reserve for system repair. This area shall have a suitable configuration and shall meet the minimum soil and site conditions of this regulation.

(g) The long-term acceptance rate for system sizing shall be based upon the most hydraulically limiting naturally occurring soil texture from the ground surface to twelve (12) inches below the bottom of the proposed wastewater infiltration trenches.

(2) Installation Requirements

(a) Effluent discharged to this system must receive a higher degree of treatment than that provided by a conventional septic tank (e.g. two (2) compartment septic tank or two (2) septic tanks in series).

(b) Where gravity flow from the septic tank to the subsurface wastewater infiltration area is utilized, the invert elevation of the septic tank outlet shall be installed at an elevation at least equal to or higher than the top of the aggregate in the highest wastewater infiltration trench(es).

(c) The required fill cap must extend at least five (5) feet beyond the limits of the wastewater infiltration trenches, and it must taper to the original soil surface at a slope not to exceed ten (10) percent. The required seventy-five (75) foot property line setback shall be measured from the point at which the fill cap taper intersects with the naturally occurring soil surface.

(d) The required fill material must be soil texture Class I, Class II, or Class III and be void of extraneous debris such as organic matter, building materials, etc.

(e) The depth of the fill cap shall provide a minimum of twelve (12) inches backfill above the top of the wastewater infiltration trench aggregate.

(f) The wastewater infiltration trench width shall be thirty-six (36) inches.

(g) All tree and brush removal shall be done in a manner that minimizes the disturbance or loss of naturally occurring soil.

(3) Final Landscaping and Drainage

(a) The septic tank and fill cap area shall be backfilled and shaped to promote the runoff of surface water.

(b) Where natural surface drainage does not exist, a swale shall be constructed adjacent to the filled area to divert surface water away from the onsite wastewater system to a positive outfall. The installation of ditches, curtain drains, and rain gutters may be required to intercept and divert water away from the onsite wastewater system location.

(c) A barrier to preclude parking and vehicular traffic over the system area may be required.

(d) Following final landscaping, seeding or sodding may be required to prevent erosion.

(e) Final approval shall be withheld until all landscaping and drainage improvements have been satisfactorily completed.

**SOUTH CAROLINA DEPARTMENT OF HEALTH AND ENVIRONMENTAL CONTROL
BUREAU OF ENVIRONMENTAL HEALTH SERVICES**

ALTERNATIVE STANDARD
SHALLOW PLACEMENT SYSTEM WITH FILL CAP FOR SITES WITH SHALLOW CLASS IV SOILS
PROGRAM 362 / CODE 370 / CODE 371 IF PUMPED

TYPICAL DESIGN ILLUSTRATION

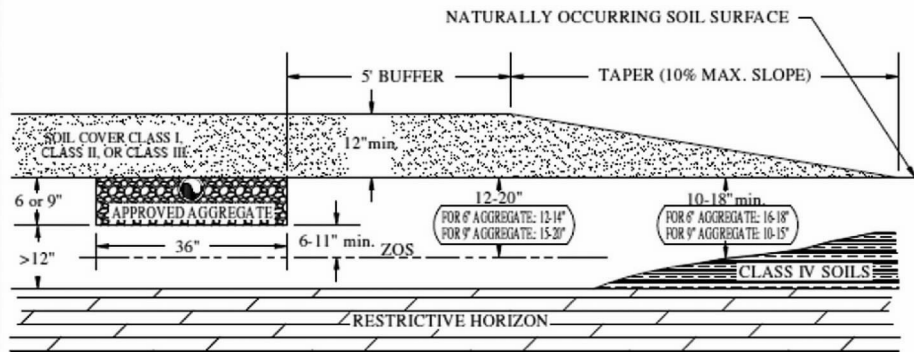

NOT TO SCALE

Depth to ZSS (in)	Depth to Class IV Soil (in)	Amount of Imported Fill Cap / Aggregate Depth (in)	Extension Factor
12	18	12 / 6	1.5
13	17	12 / 6	1.5
14	16	12 / 6	1.5
---	---	---	---
15	15	12 / 9	1.3
16	14	12 / 9	1.3
17	13	12 / 9	1.3
18	12	12 / 9	1.3
19	11	12 / 9	1.3
20	10	12 / 9	1.3

Rev. 03/09/18

HISTORY: Renumbered from 61-56.410 and amended by SCSR 45-5 Doc. No. 4979, eff May 28, 2021.

Appendix M. System Standard 380/381 - Double Aggregate Depth Wastewater Infiltration Trenches

- (1) Site/Permitting Requirements

(a) Use of the double aggregate depth option must be restricted to soils that meet all textural limitations and required offsets to the zone of saturation (ZOS) and restrictive horizons.

(b) Systems incorporating the double aggregate depth option shall be loaded on the basis of the most hydraulically limiting naturally occurring soil texture from the ground surface to twelve (12) inches below the bottom of the proposed wastewater infiltration trenches.

(c) In order to maintain the same total absorptive area as that provided by conventional aggregate depth systems, the equivalent linear footage requirement for thirty-six (36) inch wide double aggregate depth trenches shall be determined by multiplying the conventional trench requirement by a factor of 0.7.

(d) There shall be a replacement area equivalent to at least fifty (50) percent in size of the original system area held in reserve for system repair. This area shall have a suitable configuration and shall meet the minimum soil and site conditions of this regulation.

(2) Installation Requirements

(a) The wastewater infiltration trench aggregate shall be twenty-eight (28) inches in depth and shall be placed so as to provide twenty (20) inches of aggregate below the pipe, five (5) inches beside the pipe, and three (3) inches above the pipe. The aggregate shall be covered with at least nine (9) inches of backfill.

(b) The wastewater infiltration trench width shall be thirty-six (36) inches.

(c) Where gravity flow from the septic tank to the subsurface wastewater infiltration area is utilized, the invert elevation of the septic tank outlet shall be installed at an elevation at least equal to or higher than the top of the aggregate in the highest wastewater infiltration trench(es).

(3) Final Landscaping and Drainage

(a) Installation of drainage swales, ditches, curtain drains, and rain gutters may be required to divert or intercept water away from the onsite wastewater system location. The septic tank and subsurface wastewater infiltration area shall be backfilled and shaped to promote surface water runoff.

(b) Following final landscaping, seeding or sodding may be required to prevent erosion.

(c) Final approval shall be withheld until all landscaping and drainage improvements have been satisfactorily completed.

SOUTH CAROLINA DEPARTMENT OF HEALTH AND ENVIRONMENTAL CONTROL
BUREAU OF ENVIRONMENTAL HEALTH SERVICES

ALTERNATIVE STANDARD
DOUBLE AGGREGATE DEPTH SOIL ABSORPTION TRENCHES

PROGRAM 360 / CODE 380 / CODE 381 IF PUMPED

TYPICAL DESIGN ILLUSTRATION

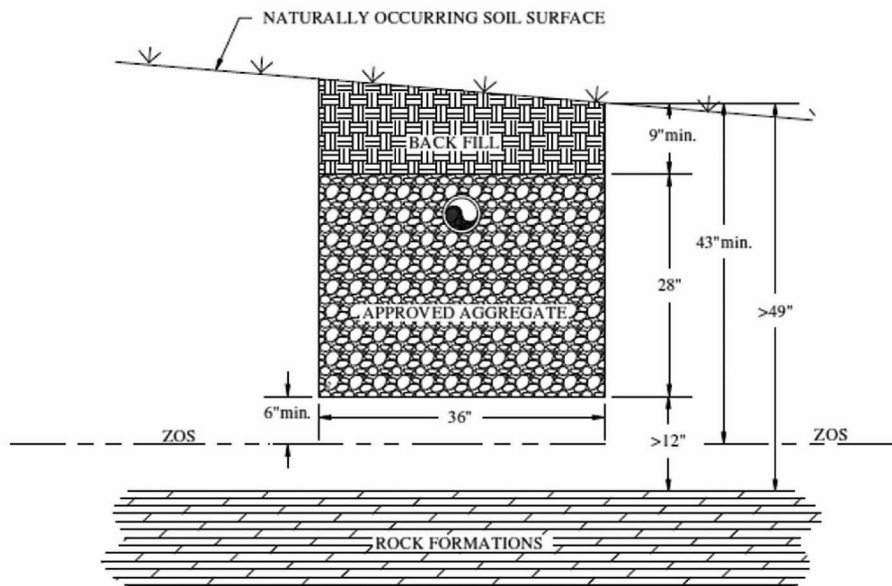

NOT TO SCALE

Rev. 03/09/18

HISTORY: Renumbered from 61-56.411 and amended by SCSR 45-5 Doc. No. 4979, eff May 28, 2021.

Appendix N. System Standard 420/421 - Mounded Infiltration System

(1) Site/Permitting Requirements

(a) The texture in the upper twelve (12) inches of naturally occurring soil must be Class I or Class II.

- (b) The soil texture in the permeable substratum must be no more limiting than Class II.
- (c) There must not be a zone of saturation (ZOS) within six (6) inches of the naturally occurring soil surface.
- (d) The depth to any restrictive horizon must be greater than twelve (12) inches below the bottom of the proposed wastewater infiltration trenches.
- (e) There shall be a replacement area equivalent to at least fifty (50) percent in size of the original system area held in reserve for system repair. This area shall have a suitable configuration and shall meet the minimum soil and site conditions of this regulation.
- (f) No part of this system can be installed within one hundred twenty-five (125) feet of the critical area line or tidal waters as determined by the Department; or within one hundred twenty-five (125) feet of the ordinary high water elevation within the banks of non-tidal, environmentally sensitive waters.
- (g) This system cannot be considered for facilities with peak flow rates in excess of four hundred eighty (480) gpd. In addition, this system shall not be considered for facilities requiring grease traps.
- (h) This system must not be utilized on sites that require serial distribution. Level installations on sloping sites can be considered if it can be demonstrated that the entire installation (i.e., side wall to side wall and end to end) will meet the required textural limitations and the required offsets to the zone of saturation and restrictive horizons.
- (i) The total linear footage of six (6) inch deep, thirty-six (36) inch wide wastewater infiltration trenches shall be increased by 100 percent over that which would be required for conventional trenches, as determined by the long-term acceptance rate of the permeable substratum.
- (j) This system may be considered for installation on contiguous lots in new subdivisions approved after the effective date of this standard provided a setback of at least seventy-five (75) feet is maintained between the system and all adjacent property lines. The seventy-five (75) foot setback shall be measured from the point at which the fill cap taper intersects with the naturally occurring soil surface.

(2) Installation Requirements

(a) Site Preparation

- (i) The naturally occurring soil surface underlying the area of the wastewater infiltration trenches shall be thoroughly tilled and mixed with the imported medium sand to a depth of six (6) inches.
- (ii) All tree and brush removal shall be done in a manner that minimizes the disturbance or loss of naturally occurring soil.

(b) Fill and System

- (i) The fill cap and buffer shall be Class I, Class II, or Class III.
- (ii) The depth of the fill cap shall provide a minimum of twelve (12) inches backfill above the top of the wastewater infiltration trench aggregate.
- (iii) Where gravity flow from the septic tank to the subsurface wastewater infiltration area is utilized, the invert elevation of the septic tank outlet shall be installed at an elevation at least equal to or higher than the top of the aggregate in the highest wastewater infiltration trench(es).
- (iv) The fill buffer shall be at least fifteen (15) feet in width.
- (v) The fill taper shall be at least twenty (20) feet in width.
- (vi) The required property line setback shall be measured from the point at which the fill cap taper intersects with the naturally occurring soil surface.
- (vii) The total fill depth, excluding the taper zone, shall be at least eighteen (18) inches above the naturally occurring soil surface.
- (viii) The wastewater infiltration trenches shall be installed in a Class I fill pad at least six (6) inches in depth, which extends five (5) feet beyond the trenches in all directions.
- (ix) The wastewater infiltration trenches require a total aggregate depth of six (6) inches.
- (x) The wastewater infiltration trench width shall be thirty-six (36) inches.

(xi) Infiltration trenches shall penetrate the permeable substratum and shall be at least two (2) feet in width containing USDA medium sand, washed concrete sand, or other material approved by the Department.

(xii) Effluent discharged to this system must receive a higher degree of treatment than that provided by a conventional septic tank (e.g., two (2) compartment septic tank or two (2) septic tanks in series).

(3) Final Landscaping and Drainage

(a) The septic tank and fill cap area shall be backfilled and shaped to promote the runoff of surface water.

(b) Where natural surface drainage does not exist, a swale shall be constructed adjacent to the filled area to divert surface water away from the onsite wastewater system to a positive outfall. The installation of ditches, curtain drains, and rain gutters may be required to intercept and divert water away from the onsite wastewater system location.

(c) A barrier to preclude parking and vehicular traffic over the system area may be required.

(d) Following final landscaping, seeding or sodding may be required to prevent erosion.

(e) Final approval shall be withheld until all landscaping and drainage improvements have been satisfactorily completed.

SOUTH CAROLINA DEPARTMENT OF HEALTH AND ENVIRONMENTAL CONTROL
BUREAU OF ENVIRONMENTAL HEALTH SERVICES

ALTERNATIVE STANDARD
MOUNDED INFILTRATION SYSTEM FOR PERMEABLE SANDS UNDERLYING RESTRICTIVE HORIZONS
PROGRAM 362 / CODE 420 / CODE 421 IF PUMPED

TYPICAL DESIGN ILLUSTRATION

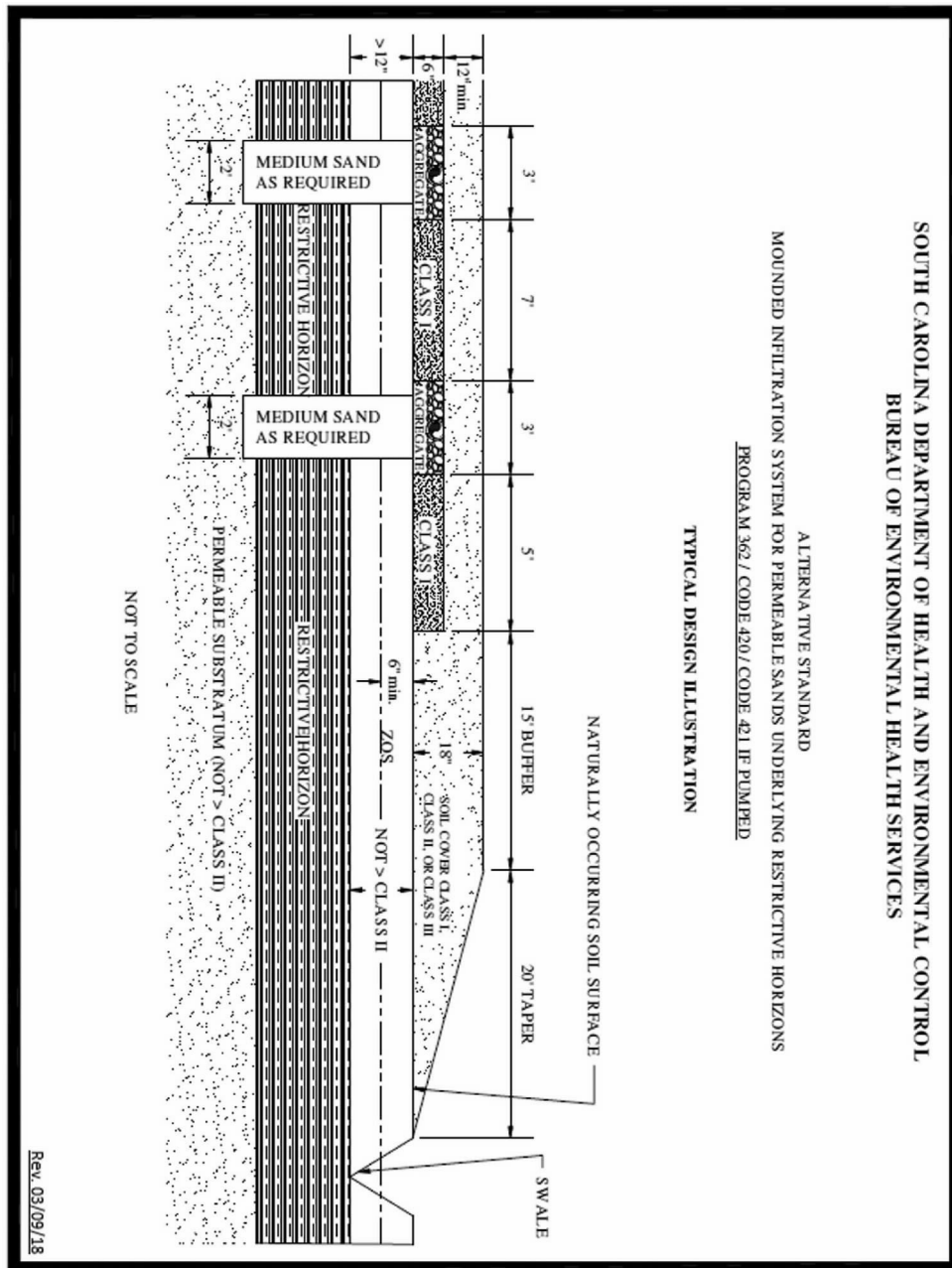

HISTORY: Renumbered from 61-56.412 and amended by SCSR 45-5 Doc. No. 4979, eff May 28, 2021.

Appendix O. System Standard 431 - Mounded Fill System

(1) Site/Permitting Requirements

(a) The texture in the upper eighteen (18) inches of naturally occurring soil must be Class I or Class II.

(b) The absorption bed within the mound shall be sized on the long-term acceptance rate of the most limiting texture in the upper eighteen (18) inches of naturally occurring soil.

(c) The linear footage of the absorption bed shall be determined in accordance with Standard 270.

(d) The absorption bed width shall be a minimum of five (5) feet and a maximum of 10 feet.

(e) Mounded fill systems must not be placed on sites with a slope in excess of three (3) percent.

(f) No part of this system can be installed within one hundred twenty-five (125) feet of the critical area line or tidal waters as determined by the Department; or within one hundred twenty-five (125) feet of the ordinary high water elevation within the banks of non-tidal, environmentally sensitive waters. Because of the long buffer, side slope, fill pad, and taper associated with this system, the one hundred twenty-five (125) foot setback shall be measured from the outer edge of the aggregate bed within the mound.

(g) There shall be a replacement area equivalent to at least fifty (50) percent in size of the original system area held in reserve for system repair. This area shall have a suitable configuration and shall meet the minimum soil and site conditions of this regulation.

(h) This system cannot be considered for facilities with peak flow rates in excess of four hundred eighty (480) gpd. In addition, this system shall not be considered for facilities requiring grease traps.

(i) Effluent discharged to this system must receive a higher degree of treatment than that provided by a conventional septic tank (e.g., two (2) compartment septic tank or two (2) septic tanks in series).

(j) This system may be considered for installation on contiguous lots in new subdivisions approved after the effective date of this standard provided a setback of at least seventy-five (75) feet is maintained between the system and all adjacent property lines. Because of the long buffer, side slope, fill pad, and taper associated with this system, the seventy-five (75) foot setback shall be measured from the outer edge of the aggregate bed within the mound.

(2) Installation Requirements

(a) Site Preparation

(i) If present within eighteen (18) inches of the naturally occurring soil surface, organic material and restrictive horizons must be removed from beneath the mound and replaced with USDA medium sand, washed concrete sand, or an equivalent material approved by the Department. The replacement area must extend five (5) feet in all directions beyond the edges of the aggregate filled absorption bed.

(ii) The naturally occurring soil surface underlying the mound shall be thoroughly tilled and mixed with the imported mound fill material to a depth of six (6) inches.

(b) Mound/Absorption Bed Requirements

(i) Low Pressure Pipe Distribution (LPP) must be utilized to preclude localized hydraulic overloading of the imported fill material and to minimize the impact on the shallow zone of saturation.

(ii) Low Pressure Pipe Distribution (LPP) must be designed and installed in accordance with Department standards or equivalent designs. The size and layout of each distribution system will vary based on the size of the filter and the needed dosing.

(iii) Pump design shall be in accordance with Department standards.

(iv) There must be at least twenty-four (24) inches of medium sand placed between the naturally occurring soil surface and the bottom of the absorption bed. The bottom surface of the absorption bed must be placed at least twenty-four (24) inches above the zone of saturation.

(v) If the slope of the site in the proposed mound area is one (1) percent or less, then the mound shall be placed on a twelve (12) inch fill pad which must extend twenty (20) feet beyond the mound in all directions. If the slope of the site in the proposed mound area is greater than one (1) percent but less than or equal to three (3) percent, then the mound shall be placed on a twelve (12) inch deep fill pad which must extend twenty (20) feet beyond the mound area on the sides of the mound; forty (40) feet beyond the mound area on the downslope side of the mound; with no fill pad required on the upslope side of the mound.

(vi) The mound and fill pad material shall be USDA medium sand, washed concrete sand, or other equivalent material approved by the Department.

(vii) The depth of the fill cap material above the absorption bed shall be nine (9) to fifteen (15) inches of soil texture Class II or Class III. Sod may be substituted for four (4) inches of this portion of the fill cap material.

(viii) The depth of the fill cap material above the mound side-slope, the twelve (12) inch deep fill pad, and the taper shall be at least four (4) inches of soil texture Class II or Class III. Sod may be substituted for this portion of the fill cap material.

(ix) A 1:2 maximum slope is required if the mound side-slope and taper are sodded.

(x) A 1:4 maximum slope is required if the mound side-slope and taper are mulched and seeded.

(3) Final Landscaping and Drainage

(a) The septic tank and mound area shall be backfilled and shaped to promote the runoff of surface water.

(b) Where natural surface drainage does not exist, a swale shall be constructed adjacent to the filled area to divert surface water away from the onsite wastewater system to a positive outfall. The installation of ditches, curtain drains, and rain gutters may be required to intercept and divert water away from the onsite wastewater system location.

(c) A barrier to preclude parking and vehicular traffic over the system area may be required.

(d) Following final landscaping, seeding, or sodding may be required to prevent erosion.

(e) Final approval shall be withheld until all landscaping and drainage improvements have been satisfactorily completed.

SOUTH CAROLINA DEPARTMENT OF HEALTH AND ENVIRONMENTAL CONTROL
BUREAU OF ENVIRONMENTAL HEALTH SERVICES

ALTERNATIVE STANDARD
MOUNDED FILL SYSTEMS
PROGRAM 362 / CODE 431

TYPICAL DESIGN ILLUSTRATION A

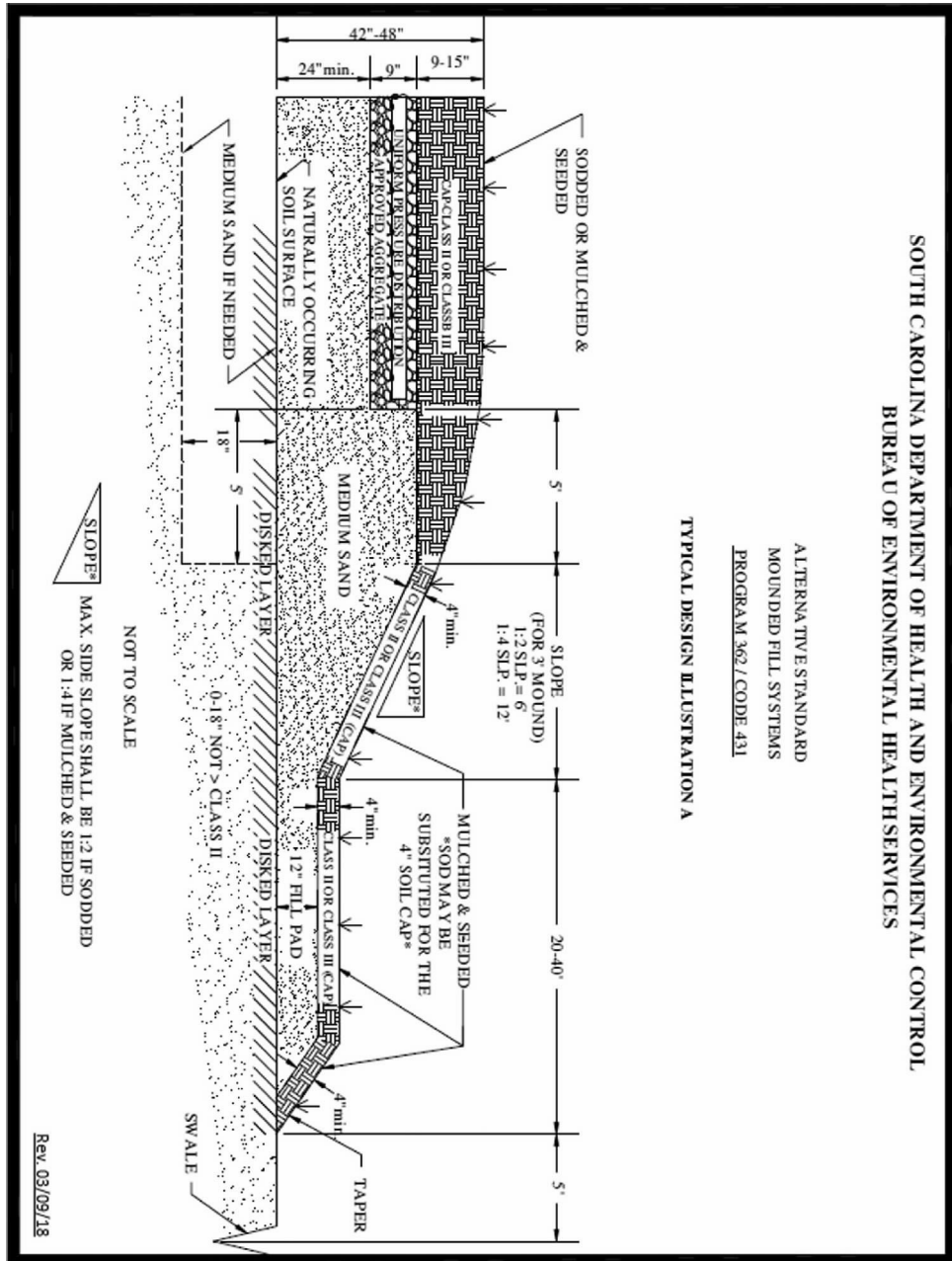

SOUTH CAROLINA DEPARTMENT OF HEALTH AND ENVIRONMENTAL CONTROL
BUREAU OF ENVIRONMENTAL HEALTH SERVICES

ALTERNATIVE STANDARD
MOUNDIED PILL SYSTEMS
PROGRAM 362 / CODE 431
TYPICAL DESIGN ILLUSTRATION B

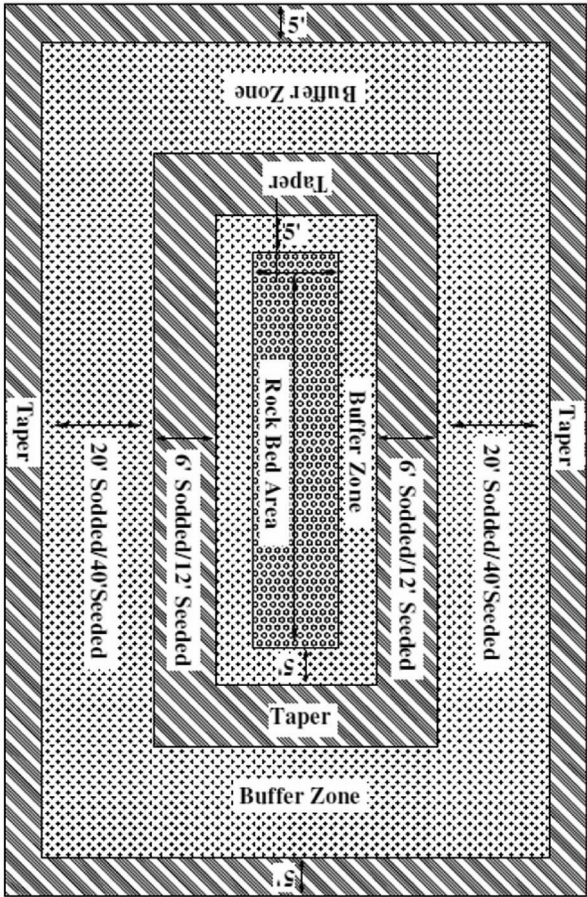

NOT TO SCALE

Rev. 03/09/18

SOUTH CAROLINA DEPARTMENT OF HEALTH AND ENVIRONMENTAL CONTROL
BUREAU OF ENVIRONMENTAL HEALTH SERVICES

ALTERNATIVE STANDARD
MOUNDIED RILL SYSTEMS
PROGRAM 362 / CODE 431
TYPICAL DESIGN ILLUSTRATION C

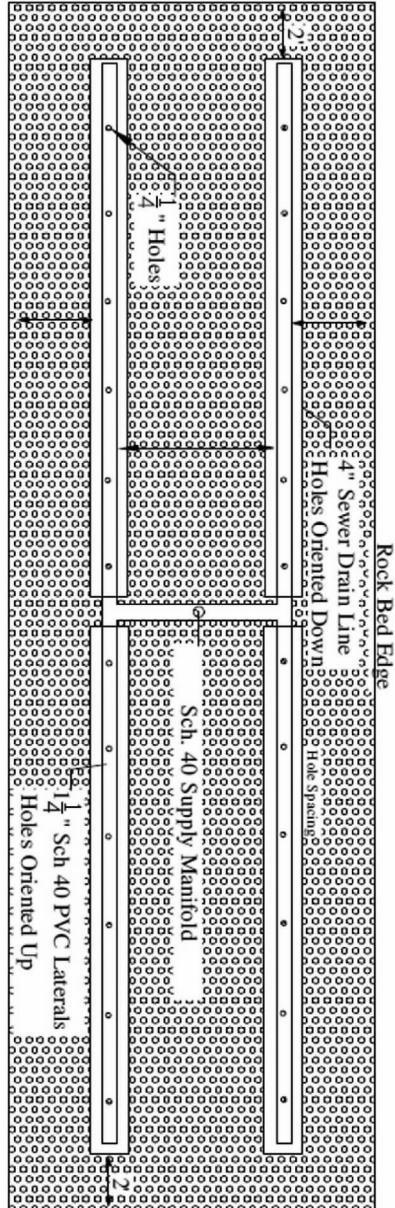

*Note: Cleanouts are required at the end of each lateral to extend to finishing grade with screw-on cleanout caps.

NOT TO SCALE

Rev. 03/09/18

HISTORY: Renumbered from 61-56.413 and amended by SCSR 45-5 Doc. No. 4979, eff May 28, 2021.

Appendix P. System Standard 601 - Elevated Infiltration System

(1) Site/Permitting Requirements

(a) The texture in the upper eighteen (18) inches of naturally occurring soil must be Class I or Class II.

(b) The filter shall not be placed on slopes greater than three (3) percent.

(c) This system cannot be considered for facilities with peak flow rates in excess of four hundred eighty (480) gpd. This system shall not be considered for facilities requiring grease traps.

(d) There shall be a buffer of at least fifty (50) feet surrounding and separating the system from all adjacent property lines. This buffer shall be measured from the retaining wall.

(e) There shall be a replacement area equivalent to at least fifty (50) percent in size of the original system area held in reserve for system repair. This area shall have a suitable configuration and shall meet the minimum soil and site conditions of this regulation.

(f) No part of this system can be installed within one hundred twenty-five (125) feet of the critical area line or tidal waters as determined by the Department or within one hundred twenty-five (125) feet of the ordinary high water elevation within the banks of non-tidal, environmentally sensitive waters.

(g) The total bottom area of the filter must be increased by fifty (50) percent above that required for conventional trenches.

(h) This system may be considered for installation on contiguous lots in new subdivisions approved after the effective date of this standard provided a setback of at least seventy-five (75) feet is maintained between the system and all adjacent property lines. The seventy-five (75) foot setback shall be measured from the point at which the retaining wall intersects the naturally occurring soil surface.

(2) Installation Requirements

(a) Site Preparation

(i) If present within eighteen (18) inches of the naturally occurring soil surface, organic material and restrictive horizons must be removed from beneath the filter and replaced with USDA medium sand, washed concrete sand, or an equivalent material approved by the Department.

(ii) The naturally occurring soil surface underlying the filter shall be thoroughly tilled and mixed with the imported filter material to a depth of six (6) inches.

(b) System Requirements

(i) The filter must be constructed to a height of at least thirty-six (36) inches above the original grade with the sewage effluent passing through at least twenty-four (24) inches of filter material.

(ii) The filter material shall be USDA medium sand, washed concrete sand, or other material approved by the Department.

(iii) The filter retaining wall shall extend at least four (4) inches above the surface of the filter material and shall penetrate the naturally occurring soil surface at least four (4) inches.

(iv) The filter retaining wall shall be constructed in accordance with the accompanying design illustrations.

(v) Effluent discharged to this system must receive a higher degree of treatment than that provided by a conventional septic tank (e.g., two (2) compartment septic tank or two (2) septic tanks in series).

(vi) The top of the filter shall be capped with Class II or Class III soil and shall slope from center to edges in order to promote surface runoff.

(c) Distribution Requirements

(i) Low Pressure Pipe Distribution (LPP) must be utilized to preclude localized hydraulic overloading of the imported fill material and to minimize the impact on the shallow zone of saturation.

(ii) Low Pressure Pipe Distribution (LPP) must be designed and installed in accordance with Department standards or equivalent designs. The size and layout of each distribution system will vary based on the size of the filter and the needed dosing.

(iii) Pump design shall be in accordance with Department standards.

(3) Final Landscaping and Drainage

(a) Fill material shall be placed around the outside of the filter to a depth of one (1) foot, and shall slope to original grade at a point five (5) feet from the retaining wall.

(b) The septic tank and filter area shall be backfilled and shaped to promote the runoff of surface water.

(c) Where natural surface drainage does not exist, a swale shall be constructed adjacent to the filter to divert surface water away from the onsite wastewater system to a positive outfall. The installation of ditches, curtain drains, and/or rain gutters may be required to intercept and divert water away from the onsite wastewater system location.

(d) Following final landscaping, seeding or sodding may be required to prevent erosion.

(e) Final approval shall be withheld until all landscaping and drainage improvements have been satisfactorily completed.

SOUTH CAROLINA DEPARTMENT OF HEALTH AND ENVIRONMENTAL CONTROL
BUREAU OF ENVIRONMENTAL HEALTH SERVICES

ALTERNATIVE STANDARD
ELEVATED INFILTRATION SYSTEM

PROGRAM 362 / CODE 601

TYPICAL DESIGN ILLUSTRATION - FIGURE A
SQUARE CONCRETE & BLOCK FILTER DETAILS

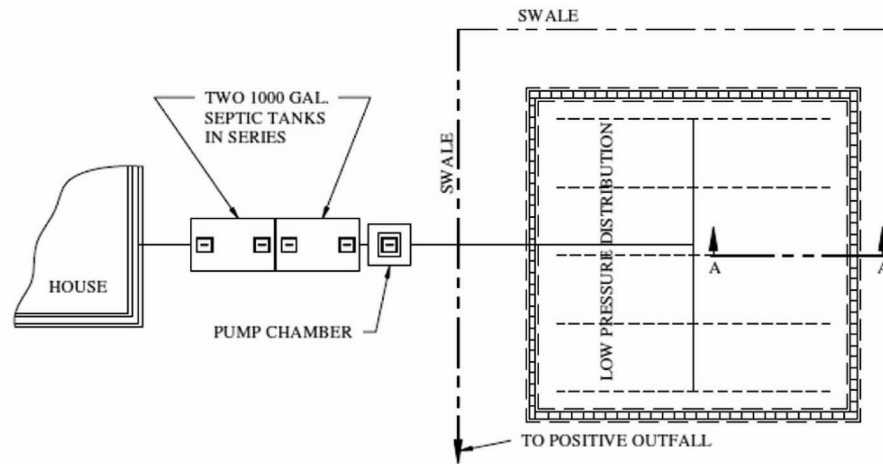

PLAN VIEW
NOT TO SCALE

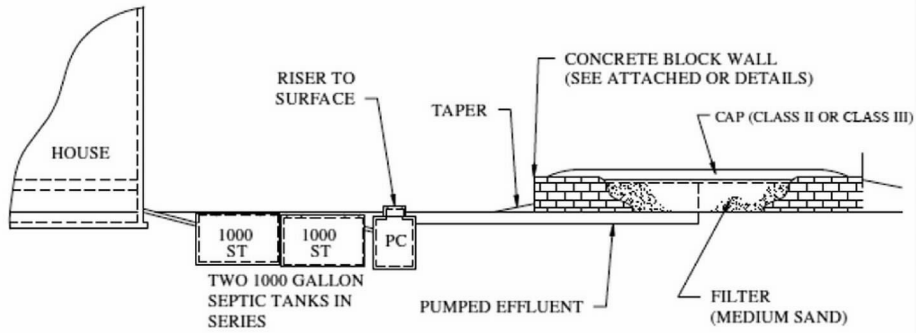

ELEVATION
NOT TO SCALE

Rev. 03/09/18

SOUTH CAROLINA DEPARTMENT OF HEALTH AND ENVIRONMENTAL CONTROL
BUREAU OF ENVIRONMENTAL HEALTH SERVICES

ALTERNATIVE STANDARD
ELEVATED INFILTRATION SYSTEM

PROGRAM 362 / CODE 601

TYPICAL DESIGN ILLUSTRATION - FIGURE A
CIRCULAR STEEL FILTER DETAILS

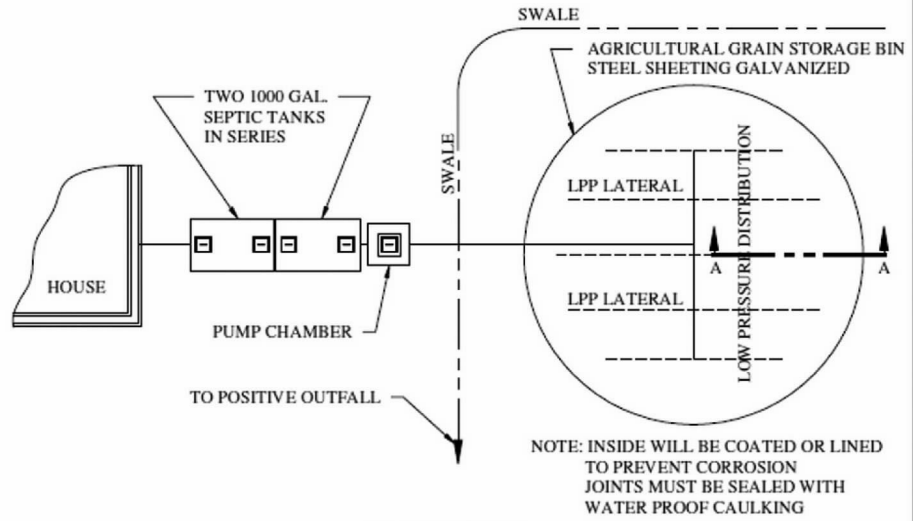

PLAN VIEW
NOT TO SCALE

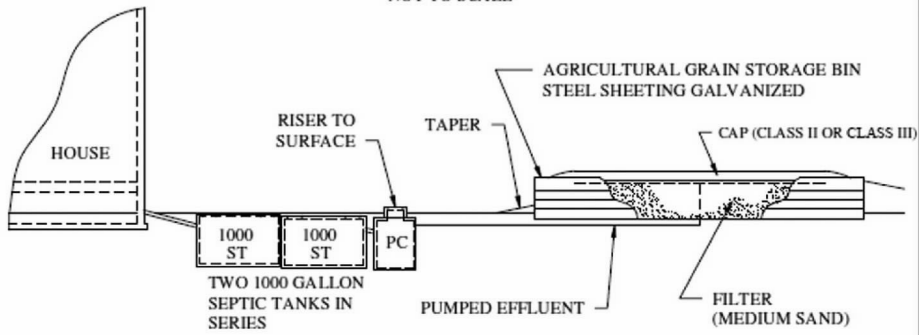

ELEVATION
NOT TO SCALE

Rev. 03/09/18

SOUTH CAROLINA DEPARTMENT OF HEALTH AND ENVIRONMENTAL CONTROL
BUREAU OF ENVIRONMENTAL HEALTH SERVICES

ALTERNATIVE STANDARD
ELEVATED INFILTRATION SYSTEM

PROGRAM 362 / CODE 601

TYPICAL DESIGN ILLUSTRATION - FIGURE B
SQUARE CONCRETE & BLOCK FILTER DETAILS

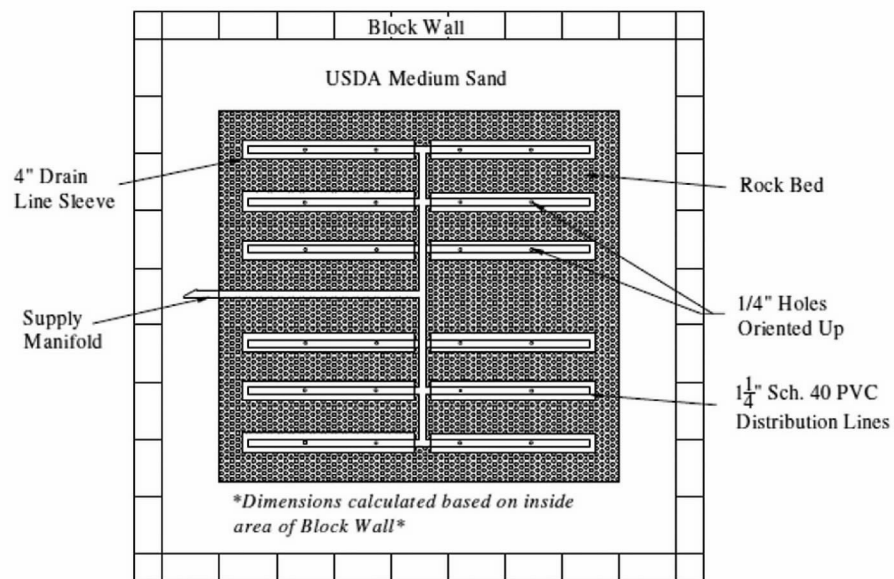

EACH LATERAL TO BE INSTALLED IN A ROCK BED

ALL LATERAL PRESSURE LINES ARE REQUIRED TO HAVE ELBOWS AT THE ENDS OF EACH LINE AND EXTEND TO FINISHING GRADE WITH SCREW-ON CLEANOUT CAPS

ALL HOLES ARE TO BE EQUALLY SPACED FROM ENDS OF EACH LINE AND BETWEEN EACH HOLE

ELEVATION
NOT TO SCALE

Rev. 03/09/18

SOUTH CAROLINA DEPARTMENT OF HEALTH AND ENVIRONMENTAL CONTROL
BUREAU OF ENVIRONMENTAL HEALTH SERVICES

ALTERNATIVE STANDARD
ELEVATED INFILTRATION SYSTEM

PROGRAM 362 / CODE 601

TYPICAL DESIGN ILLUSTRATION - FIGURE B
CIRCULAR STEEL FILTER DETAILS

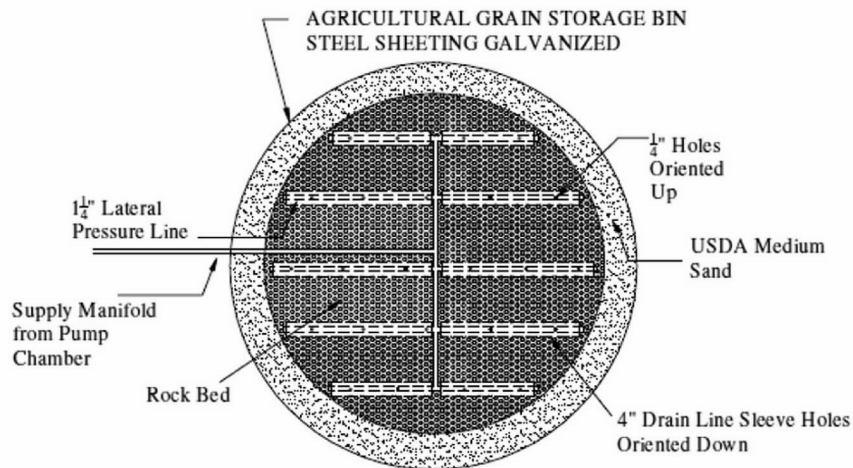

EACH LATERAL TO BE INSTALLED IN A ROCK BED

ALL LATERAL PRESSURE LINES ARE REQUIRED TO HAVE ELBOWS AT THE ENDS OF EACH LINE AND EXTEND TO FINISHING GRADE WITH SCREW-ON CLEANOUT CAPS

ALL HOLES ARE TO BE EQUALLY SPACED FROM ENDS OF EACH LINE AND BETWEEN EACH HOLE

ELEVATION
NOT TO SCALE

Rev. 03/09/18

SOUTH CAROLINA DEPARTMENT OF HEALTH AND ENVIRONMENTAL CONTROL
BUREAU OF ENVIRONMENTAL HEALTH SERVICES

ALTERNATIVE STANDARD
ELEVATED INFILTRATION SYSTEM

PROGRAM 362 / CODE 601

TYPICAL DESIGN ILLUSTRATION -FIGURE C

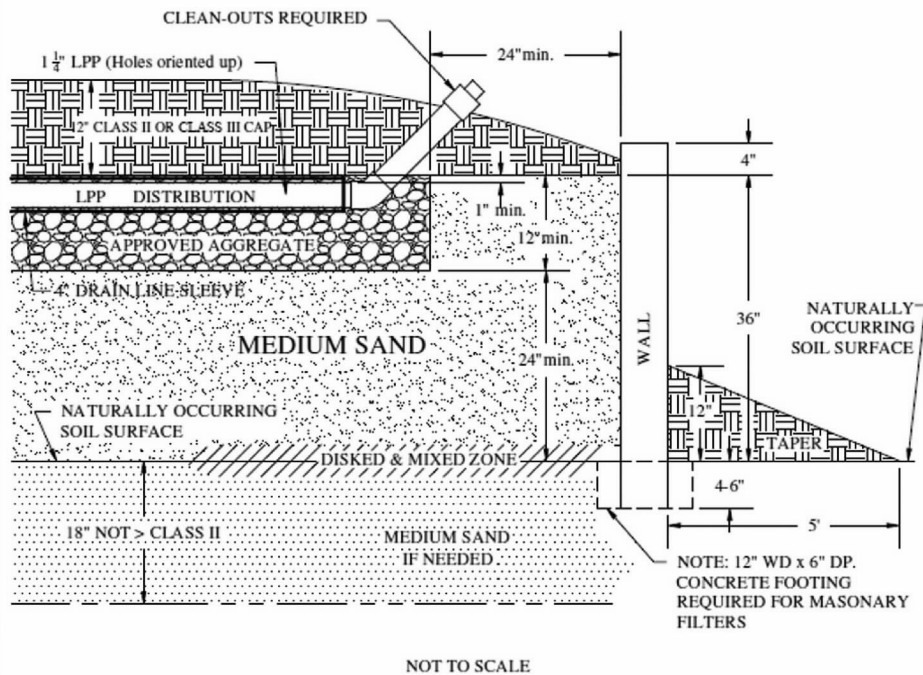

Rev. 03/09/18

HISTORY: Renumbered from 61-56.414 and amended by SCSR 45-5 Doc. No. 4979, eff May 28, 2021.

**Appendix Q. System Standard 610 - Specialized Onsite Wastewater System Designs
(less than 1500 gpd)**

- (1) Site/Permitting Requirements

(a) This Standard shall not apply to the following:

- (i) Projects where two (2) or more pieces of deeded property will share a common system.
- (ii) Residential or commercial projects where the individual or combined peak sewage flow is estimated to be in excess of fifteen hundred (1500) gpd.
- (iii) Projects that discharge wastes containing high amounts of fats, grease and oil, including restaurants and other food service facilities, unless the system manufacturer certifies that the proposed system is designed to treat such high strength wastes.
- (iv) Industrial process wastewater.

(b) A site may be considered for a specialized onsite wastewater system design if written documentation provided by a Registered Professional Engineer licensed in South Carolina, including soil studies performed by a licensed person meeting the criteria of Section 102.1(2)(b) or (c), indicates that the proposed system will function satisfactorily and in accordance with all requirements of this regulation. Such substantiating documentation must include the following:

(i) A Soils Report from a licensed person meeting the criteria of Section 102.1(2)(b) or (c) including detailed soil profile descriptions and Soil Series classification(s) utilizing methods and terminology specified in the Field Book for Describing and Sampling Soils; depth to the zone of saturation utilizing methods and terminology outlined in Redoximorphic Features for Identifying Aquic Conditions, and other appropriate principles specified in Soil Taxonomy; the depth to restrictive horizons; and a description of topography and other pertinent land features.

(ii) For drain field and replacement areas with a less than fifteen (15) inch zone of saturation, no part of a specialized onsite wastewater system may be installed within one hundred twenty-five (125) feet of the critical area line or tidal waters as determined by the Department or within seventy-five (75) feet of the ordinary high water elevation within the banks of non-tidal, environmentally sensitive waters.

(iii) There shall be a replacement area equivalent to at least fifty (50) percent in size of the original system area held in reserve for system repair. This area shall have a suitable configuration and shall meet the minimum soil and site conditions of this regulation.

(iv) A plan that has been sealed, signed and dated by a Registered Professional Engineer licensed in South Carolina certifying that the proposed onsite wastewater system has been designed in accordance with the requirements of this regulation and will function satisfactorily. The plan should also show an area equivalent to at least fifty (50) percent in size of the original system held in reserve for system repair.

(v) The manufacturer's recommendations for operation and maintenance of the system, and the consulting Registered Professional Engineer's management plan to meet this. For systems that have mechanical components and/or require a higher degree of maintenance to ensure the proper treatment and disposal of Domestic Wastewater, an operation and maintenance (O&M) plan must be developed by the designing Registered Professional Engineer to be given to the party who is ultimately responsible for the operation of the system. O&M plans must be recorded along with the property deed and must run with the land.

(c) Any permit to construct that is issued pursuant to this standard shall be based upon the consulting Registered Professional Engineer's design, certification, and other supporting documentation provided by the licensed person meeting the criteria of Section 102.1(2)(b) or (c).

(d) The consulting Registered Professional Engineer shall be responsible for supervising construction of the system and providing the Department with a certified as-built plan of the actual installation containing all details required by the Department. The certified as-built plan must be submitted to the Department within two (2) business days of completing the system installation. If the construction schedule for a specialized system installation is more than forty-eight (48) hours, the Department must be notified in advance of the beginning of construction. Any Final Approval that is released pursuant to this standard shall be based upon this engineering certification.

HISTORY: Amended by State Register Volume 40, Issue No. 5, Doc. No. 4591, eff May 27, 2016. Renumbered from 61-56.415 and amended by SCSR 45-5 Doc. No. 4979, eff May 28, 2021.

Appendix R. Curtain Drain Standard

(1) Minimum Construction Requirements

(a) Only pipe having received written approval from the Department may be utilized in curtain drains. This approval shall be based upon the pipe meeting all applicable ASTM standards.

(b) The aggregate used in curtain drains shall be a material approved by the Department.

(c) The curtain drain trench utilizing tire chips or gravel or a similar type of Department approved product shall be at least six (6) inches wide.

(d) The curtain drain shall be placed ten (10) feet upslope and twenty-five (25) feet downslope of a subsurface wastewater infiltration area or repair area. Where the aggregate portion of the curtain is installed at the same or lower (downslope) elevation relative to an adjacent subsurface wastewater infiltration area or repair area, the aggregate portion of the curtain must be a minimum of twenty-five (25) feet from the adjacent subsurface wastewater infiltration area or repair area.

(e) The trench bottom shall have a uniform slope to the discharge point. Trench excavation with a ditch wick is permissible provided the trench bottom has a uniform downslope gradient.

(f) The solid discharge (non-aggregate) line shall be fifteen (15) feet from adjacent subsurface wastewater infiltration area or repair area.

(g) The downslope side of the trench toward the subsurface wastewater infiltration area shall have a minimum six (6) mil poly or an equivalent strength treated impervious material draped from the trench surface to the trench bottom to prevent groundwater from bridging the curtain drain.

(h) Agricultural drainpipe (slitted) with a minimum diameter of four (4) inches shall be placed along the trench bottom in the aggregate portion. Perforated pipe is acceptable, provided the perforations are installed facing either sideways or upward.

(i) There shall be at least two (2) inches of aggregate beneath the drainpipe.

(j) The aggregate shall be brought to at least six (6) inches from the ground surface.

(k) The aggregate shall be covered with a strong, untreated pervious material to prevent infiltration of back fill material.

(l) Solid drainpipe with a minimum diameter of four (4) inches shall be placed along the trench bottom from the aggregate to the discharge point.

(m) The curtain drain must discharge to the ground surface past the last wastewater infiltration trench line.

(n) Rodent barriers on discharge pipe outlet(s) are required.

(o) If the curtain drain's trench bottom depth exceeds thirty (30) inches, it shall be inspected prior to the aggregate being installed to ensure proper trench depth and grade. It is acceptable to place the pipe and aggregate in the trench prior to the final inspection when a probe rod inspection port can be used to accurately measure trench bottom depth.

**SOUTH CAROLINA DEPARTMENT OF HEALTH AND ENVIRONMENTAL CONTROL
BUREAU OF ENVIRONMENTAL HEALTH SERVICES**

CURTAIN DRAIN STANDARD

TYPICAL DESIGN SKETCH

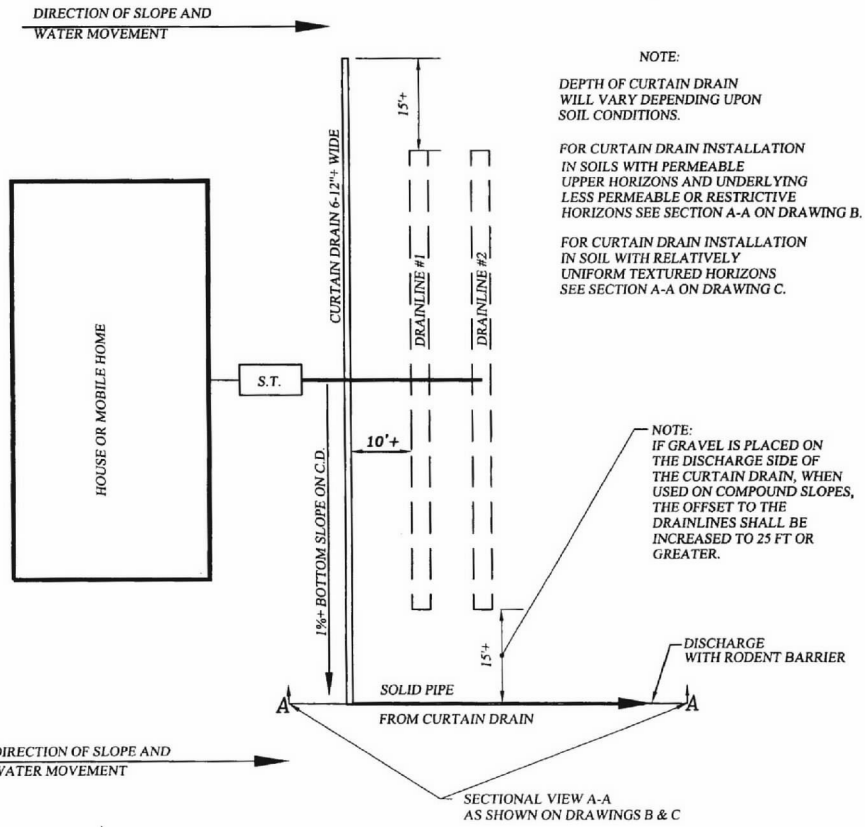

DRAWING A

**SOUTH CAROLINA DEPARTMENT OF HEALTH AND ENVIRONMENTAL CONTROL
BUREAU OF ENVIRONMENTAL HEALTH SERVICES
CURTAIN DRAIN STANDARDS**

CURTAIN DRAIN INSTALLATION IN SOILS WITH RESTRICTIVE OR LESS PERMEABLE HORIZONS BELOW THE DRAINFIELD
TYPICAL DESIGN SKETCH

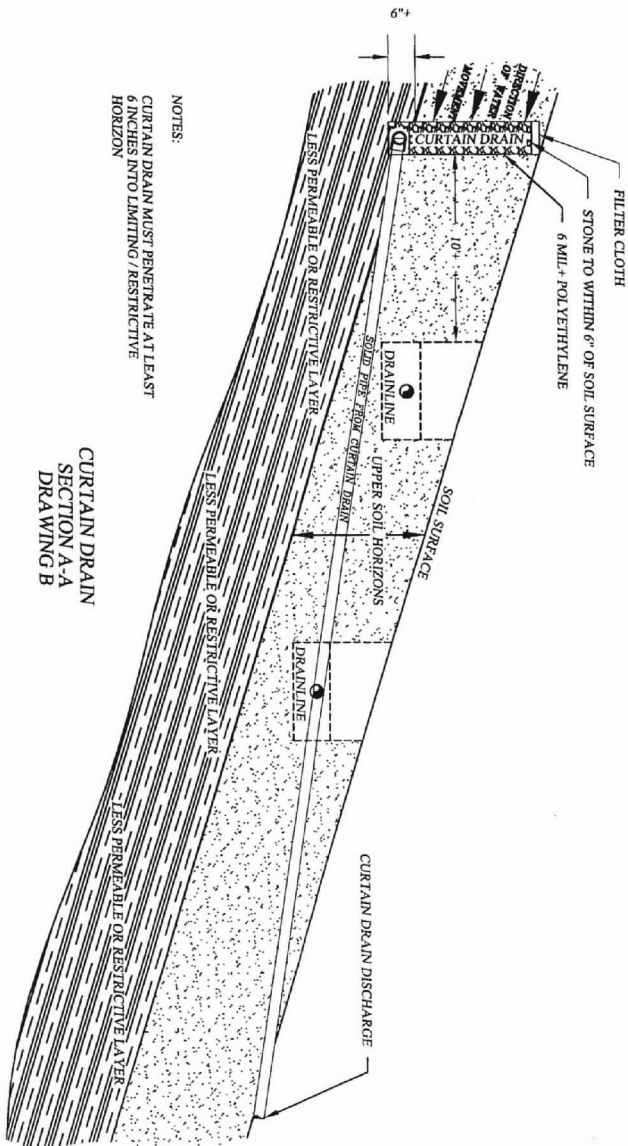

NOTES:
CURTAIN DRAIN MUST PENETRATE AT LEAST
6 INCHES INTO LIMITING / RESTRICTIVE
HORIZON

CURTAIN DRAIN
SECTION A-A
DRAWING B

**SOUTH CAROLINA DEPARTMENT OF HEALTH AND ENVIRONMENTAL CONTROL
BUREAU OF ENVIRONMENTAL HEALTH SERVICES
CURTAIN DRAIN STANDARDS**

CURTAIN DRAIN INSTALLATION IN SOILS WITH RELATIVELY UNIFORM HORIZONS
TYPICAL DESIGN SKETCH

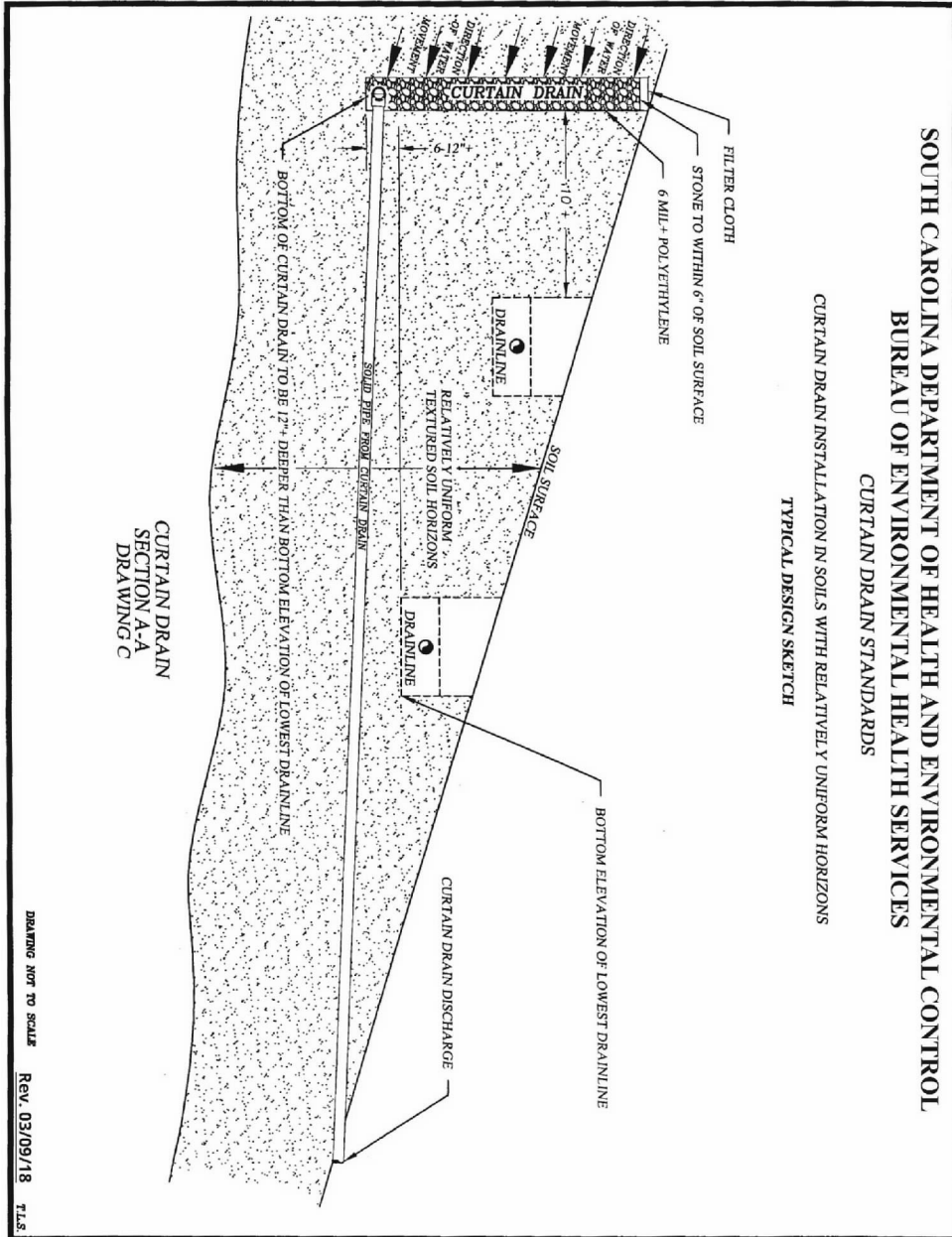

HISTORY: Renumbered from 61-56.416 and amended by SCSR 45-5 Doc. No. 4979, eff May 28, 2021.

Appendix S. Nonwater-Carried Sewage Treatment Systems

(1) The permitting of nonwater-carried sewage treatment systems, such as a biological, composting, or incinerating toilet, may be considered for toilet wastes when a proposed site is unsuitable for the issuance of an onsite wastewater system permit under the system standards in Appendices A through

R. Nonwater-carried sewage treatment systems shall be designed, installed, maintained, and operated without endangering public health, the environment, or creating a nuisance.

(2) With the application for a permit to construct, all applicants seeking to install a nonwater-carried sewage treatment system must submit to the Department plans from a Registered Professional Engineer licensed in South Carolina that describe the design and installation of the proposed nonwater-carried sewage treatment system and demonstrate the following:

(a) The system complies with all local codes and ordinances.

(b) All products and processes meet applicable National Sanitation Foundation (NSF) Standards and American National Standards Institute (ANSI) Standard 41 and bear the seal of approval of the NSF or an equivalent testing and certification program.

(c) Compartment and appurtenances are insect and vector-proof and have continuous exterior ventilation.

(d) There will be no liquid wastewater produced by the system.

(e) Methods for training the owner/operator in the proper use, function, and maintenance of the system including safe handling and disposal methods for any residue generated by the system.

(f) All manufacturer recommendations for installation, operation, and maintenance will be followed.

(3) Applicants seeking to install a nonwater-carried sewage treatment system at a site where water under pressure will be connected to the structure and gray water is generated (from showers, sinks, etc.), but where nonwater-carried sewage treatment systems will be the only means for toilet waste disposal, must:

(a) Submit plans from a Registered Professional Engineer licensed in South Carolina that meet the requirements of Appendix S, paragraphs (2)(a) through (f), for all toilet wastes; and

(b) Apply for and obtain a Department permit to construct and approval to operate an onsite wastewater system for treatment of gray water. This system must meet all permit, licensing, and onsite wastewater system requirements under this regulation, except that the initial system size may be reduced by twenty-five (25) percent.

(4) A licensed installer is not required for the installation of a nonwater-carried sewage treatment system under this standard. However, engineering certifications using the applicable Department form must be submitted to the Department before the Department will issue an approval to operate a system under this standard.

HISTORY: Added by SCSR 45-5 Doc. No. 4979, eff May 28, 2021.

Appendix T. Wastewater Combustion Systems

(1) Wastewater combustion systems may be considered when a proposed site is unsuitable for the issuance of an onsite wastewater system permit under the system standards in Appendices A through R. A wastewater combustion system shall be designed, installed, maintained, and operated without endangering public health, the environment, or creating a nuisance.

(2) With the application for a permit to construct, all applicants seeking to install a wastewater combustion system must submit to the Department plans from a Registered Professional Engineer licensed in South Carolina that describe the design and installation of the proposed wastewater combustion system and demonstrate the following:

(a) The system complies with all local codes and ordinances.

(b) CSA Group certification of the wastewater combustion system in the United States.

(c) The system must be of adequate size to handle the wastewater volume and peak flow generated by the structure.

(d) Compartment and appurtenances are insect and vector-proof and have continuous exterior ventilation.

(e) All liquid wastewater produced must be sent to the combustion system. Liquid wastewater must not be sent to an onsite wastewater system or held in a storage system to be pumped and hauled.

(f) Methods for training the owner/operator in the proper use, function, and maintenance of the system including safe handling and disposal methods for any residue generated by the system.

(g) All manufacturer recommendations for installation, operation, and maintenance will be followed.

(3) Applicants seeking to install a wastewater combustion system for toilet wastes in conjunction with an onsite wastewater system for treatment of gray water generated by the structure must:

(a) Submit to the Department plans from a Registered Professional Engineer licensed in South Carolina that meet the requirements of Appendix T, paragraphs (2)(a) through (g), for all toilet wastes; and

(b) Apply for and obtain a Department permit to construct and approval to operate an onsite wastewater system for treatment of gray water. This system must meet all permit, licensing, and onsite wastewater system requirements under this regulation, except that the initial system size may be reduced by twenty-five (25) percent.

(4) A licensed installer is not required for the installation of a wastewater combustion system under this standard. However, engineering certifications using the applicable Department form must be submitted to the Department before the Department will issue an approval to operate a system under this standard.

HISTORY: Added by SCSR 45-5 Doc. No. 4979, eff May 28, 2021.

Appendix U. Gray Water Subsurface Reuse Systems

(1) With the application for a permit to construct, all applicants seeking to install a gray water subsurface reuse system must submit to the Department for approval plans from a Registered Professional Engineer licensed in South Carolina that describe the design and installation of the proposed gray water subsurface reuse system and demonstrate the following:

(a) The system complies with all local codes and ordinances.

(b) The system must be of adequate size to handle the wastewater volume and peak flow generated by the structure.

(c) Compartment and appurtenances are insect and vector-proof and have continuous exterior ventilation.

(d) All gray water produced by the structure must be sent to the gray water subsurface reuse system or to a separate onsite wastewater system for treatment and disposal of domestic wastewater. Liquid wastewater must not be held in a storage system to be pumped and hauled.

(e) Methods for training the owner/operator in the proper use, function, and maintenance of the system including safe handling and disposal methods for any residue generated by the system.

(f) All manufacturer recommendations for installation, operation, and maintenance will be followed.

(2) This regulation does not apply to or permit the reuse of gray water for any purpose, or by any means, other than subsurface irrigation. This regulation also does not apply to or permit any reuse or recirculation of gray water within the confines of (i.e., via the plumbing within) a dwelling unit, building, business, or other structure.

(3) A property owner proposing to install a gray water subsurface reuse system for the reuse and disposal of gray water shall ensure that there is also an approved method of treatment and disposal for all other domestic wastewater and sewage generated by the structure. An onsite wastewater system for the treatment and disposal of all other domestic wastewater and sewage generated by the structure shall meet all requirements of this regulation, including standard sizing requirements.

(4) A licensed installer is not required for the installation of a gray water subsurface reuse system under this standard. However, engineering certifications using the applicable Department form must be submitted to the Department before the Department will issue an approval to operate a system under this standard.

HISTORY: Added by SCSR 45-5 Doc. No. 4979, eff May 28, 2021.

401. Transferred.

HISTORY: Former Regulation, titled Appendix A - System Standard 150 - Large (Greater Than 1500 GPD) and Community Onsite Wastewater Systems, transferred by SCSR 45-5 Doc. No. 4979, eff May 28, 2021. See, now S.C. CODE REGS. 61-56.400, App. B.

402. Transferred.

HISTORY: Former Regulation, titled Appendix B - System Standard 210/211 - Shallow Placement with 9-inch Aggregate Depth, transferred by SCSR 45-5 Doc. No. 4979, eff May 28, 2021. See, now S.C. CODE REGS. 61-56.400, App. C.

403. Transferred.

HISTORY: Former Regulation, titled Appendix C - System Standard 220/221 - Shallow Placement with 6-inch Aggregate Depth, transferred by SCSR 45-5 Doc. No. 4979, eff May 28, 2021. See, now S.C. CODE REGS. 61-56.400, App. D.

404. Transferred.

HISTORY: Former Regulation, titled Appendix D - System Standard 230/231 - Shallow Placement System with 14-inch Aggregate Depth with Fill Cap, transferred by SCSR 45-5 Doc. No. 4979, eff May 28, 2021. See, now S.C. CODE REGS. 61-56.400, App. E.

405. Transferred.

HISTORY: Former Regulation, titled Appendix E - System Standard 240/241 - Ultra-shallow Placement with 6-inch Aggregate Depth with Fill Cap, transferred by SCSR 45-5 Doc. No. 4979, eff May 28, 2021. See, now S.C. CODE REGS. 61-56.400, App. F.

406. Transferred.

HISTORY: Former Regulation, titled Appendix F - System Standard 250/251 - Reservoir Infiltration System for Soils with Expansive Clay, transferred by SCSR 45-5 Doc. No. 4979, eff May 28, 2021. See, now S.C. CODE REGS. 61-56.400, App. G.

407. Transferred.

HISTORY: Former Regulation, titled Appendix G - System Standard 260/261 - 9-inch Shallow Placement System with Fill Cap, transferred by SCSR 45-5 Doc. No. 4979, eff May 28, 2021. See, now S.C. CODE REGS. 61-56.400, App. H.

408. Transferred.

HISTORY: Former Regulation, titled Appendix H - System Standard 270/271 - Alternative Trench Width and Depth Systems, transferred by SCSR 45-5 Doc. No. 4979, eff May 28, 2021. See, now S.C. CODE REGS. 61-56.400, App. I.

409. Transferred.

HISTORY: Former Regulation, titled Appendix I - System Standard 280/281 - Reservoir Infiltration System for Soils with Expansive Clay Shallow Rock Formations, transferred by SCSR 45-5 Doc. No. 4979, eff May 28, 2021. See, now S.C. CODE REGS. 61-56.400, App. J.

410. Transferred.

HISTORY: Former Regulation, titled Appendix J - System Standard 370/371 - Shallow Placement with Fill Cap for Sites with Shallow Class IV Soil, transferred by SCSR 45-5 Doc. No. 4979, eff May 28, 2021. See, now S.C. CODE REGS. 61-56.400, App. L.

411. Transferred.

HISTORY: Former Regulation, titled Appendix K - System Standard 380/381 - Double Aggregate Depth Wastewater Infiltration Trenches, transferred by SCSR 45-5 Doc. No. 4979, eff May 28, 2021. See, now S.C. CODE REGS. 61-56.400, App. M.

412. Transferred.

HISTORY: Former Regulation, titled Appendix L - System Standard 420/421 - Mounded Infiltration System, transferred by SCSR 45-5 Doc. No. 4979, eff May 28, 2021. See, now S.C. CODE REGS. 61-56.400, App. N.

413. Transferred.

HISTORY: Former Regulation, titled Appendix M - System Standard 431 - Mounded Fill System, transferred by SCSR 45-5 Doc. No. 4979, eff May 28, 2021. See, now S.C. CODE REGS. 61-56.400, App. O.

414. Transferred.

HISTORY: Former Regulation, titled Appendix N - System Standard 601 - Elevated Infiltration System, transferred by SCSR 45-5 Doc. No. 4979, eff May 28, 2021. See, now S.C. CODE REGS. 61-56.400, App. P.

415. Transferred.

HISTORY: Former Regulation, titled Appendix O - System Standard 610 - Specialized Onsite Wastewater System Designs (Less Than 1500 GPD), had the following history: Amended by State Register Volume 40, Issue No. 5, Doc. No. 4591, eff May 27, 2016. Transferred by SCSR 45-5 Doc. No. 4979, eff May 28, 2021. See, now S.C. CODE REGS. 61-56.400, App. Q.

416. Transferred.

HISTORY: Former Regulation, titled Appendix P - Curtain Drain Standard, transferred by SCSR 45-5 Doc. No. 4979, eff May 28, 2021. See, now S.C. CODE REGS. 61-56.400, App. R.

500. Long-Term Acceptance Rate Standard for Onsite Wastewater Systems.

USDA-NRCS SOIL TEXTURE	SOIL CHARACTERISTICS WHEN MOIST (FIELD TEST)	LONG-TERM ACCEPTANCE RATE (GPD/SF)	
Sand (S)	Sand has a gritty feel, does not stain the fingers, and does not form ribbon or ball when wet or moist.	0.9 - 1.0	Class I
Loamy Sand (LS)	Loamy sand has a gritty feel, stains the fingers, forms a weak ball, and cannot be handled without breaking.		
Sandy Loam (SL)	Sandy loam has a gritty feel and forms a ball that can be picked up with the fingers and handled with care without breaking.	0.7 - 0.8	Class II
Loam (L)	Loam may have a slightly gritty feel but does not show a fingerprint, and forms only short ribbons from 0.25 - 0.50 inch. Loam will form a ball that can be handled without breaking.		
Sandy Clay Loam (SCL)	Sandy clay loam has a gritty feel but contains enough clay to form a firm ball and may ribbon from 0.75 - 1.0 inch.	0.5 - 0.6	Class III
Clay Loam (CL)	Clay loam is sticky when moist, forms a ribbon of 1.0 - 2.0 inches, and produces a slight sheen when rubbed with the thumbnail. Clay loam produces a nondistinct fingerprint.		
Silt Loam (SiL)	Silt loam has a floury feel when moist and will show a fingerprint, but will not ribbon and forms only a weak ball.		Class IV
Silt (Si)	Silt has a floury feel when moist and is sticky when wet but will not ribbon and forms a ball that will tolerate some handling.	0.1 - 0.4	
Silty Clay Loam (SiCL)	Silty clay loam has a slight floury feel, is sticky when moist, and will ribbon from 1.0 - 2.0 inches. Rubbing with thumbnail produces a moderate sheen. Silty clay loam produces a distinct fingerprint.		
Sandy Clay (SC)	Sandy clay is plastic, gritty, and sticky when moist, forms a firm ball, and produces a ribbon in excess of 2.0 inches.		
Clay (C)	Clay is both sticky and plastic when moist, produces a ribbon in excess of 2.0 inches, produces a high sheen		

USDA-NRCS SOIL TEXTURE	SOIL CHARACTERISTICS WHEN MOIST (FIELD TEST)	LONG-TERM ACCEP- TANCE RATE (GPD/SF)
	when rubbed with the thumbnail, and forms a strong ball resistant to breaking.	
Silty Clay (SiC)	Silty clay has a slight floury feel, is both sticky and plastic when moist, forms a ball, and produces a ribbon in excess of 2.0 inches.	

(1) The long-term acceptance rate for system sizing shall be based upon the most hydraulically limiting naturally occurring soil texture from the ground surface to twelve (12) inches below the bottom of the proposed wastewater infiltration trenches. Alternative and experimental systems installed beneath expansive soils shall be sized at a long-term acceptance rate not to exceed 0.2–0.25 gpd/sf as specified in approved standards.

(2) Soil texture shall be estimated by field testing as described above. Laboratory determination of soil texture may be substituted for field testing when conducted in accordance with: (1) Bouyoucos, G.J. 1962. Hydrometer Method Improved for Making Particle Size Analyses of Soils. Agron. J. 53:464–465; (2) ASTM D-422, Procedures for Sieve and Hydrometer Analyses; or (3) the Pipette Method (ASA-CSSA-SSSA), USDA Methods of Soils Analysis, Soil Survey Laboratory Information Manual, and Soil Survey Laboratory Methods Manual.

(3) The total linear feet (lf) for conventional onsite wastewater systems shall be calculated by dividing the peak daily flow (gpd) by the long-term acceptance rate (gpd/sf) and dividing the result by the trench width (ft): $lf = \frac{gpd}{gpd/sf \times ft}$. The total linear feet for alternative systems may either be increased or decreased in accordance with factors specified in alternative standards.

HISTORY: Amended by SCSR 45–5 Doc. No. 4979, eff May 28, 2021.

501. Peak Sewage Flow Rate Standard.

ESTABLISHMENT	UNIT	PEAK FLOW RATE GAL/UNIT/DAY
Airport (Not Including Food Service)	Passenger	3
Assembly Halls	Person	3
Bar (Not Including Food Service)	Customer	5
	Seat	15
Beauty/Style Shops/Barber Shops	Chair	100
Businesses/Offices/Factories	Employee/Shift	15
	Transient Employee	10
(Add for Showers)	(4 hrs or Less/Shift) Employee	10
Camps (No Laundry)		
-Labor/Summer/Retreat	Person	35
(Separate Food Service)	Person	10
(Separate Bath House)	Person	25
-Day Camps (with meal)	Person	15
(without meal)	Person	10
Campgrounds (No Laundry)		
-Full Water/Sewer	Campsite	120
-No Sewer Risers, Bathhouse only	Campsite	50
(Add for Dump Station)	Campsite	40
Car Wash (Non-automatic)	Bay	500
Church (No Daycare)		
-With Kitchen	Seat	3
-Without Kitchen	Seat	2
-Family Life Center	Person	5
Day Care	Child	10
Food Service		
-Full Service Utensils	Meal	4
	Person	10

ESTABLISHMENT	UNIT	PEAK FLOW RATE GAL/UNIT/DAY
-Paper/Plastic Utensils	Seat	40
Golf Course Club House (Not Including Foodservice)	Player	Reduce by 50 percent 10
Kennel	Run	25
Laundromat	Machine	500
Mortuary (for domestic wastewater only, no infectious waste)	Body	25
Hotel/Motel (Not Including Food Service)	Room	100
Picnic Park	Visitor	10
Public Restroom	User	3
Residential/Dwelling	Bedroom	120
Residential Care	Resident	100
Residential Out-Building (not used as a dwelling; e.g., pool house, private workshop or garage with private-use bathroom with toilet and sink; barn with hand-wash sink)	1 to 3 Users	
	Without washing machine	60
	With washing machine/shower	120
School		
-With Cafeteria, Gym & Showers	Student	15
-With Cafeteria only	Student	10
-Without Cafeteria, Gym or Showers	Student	8
-Boarding School	Person	60
Stadium (Not Including Food Service)	Seat/Occupancy	3
Swimming Area Bathhouse	Person	10
Visitor Center	Visitor	5

The peak flow rate (gpd) for non-residential facilities may either be increased or reduced when comparable peak water consumption data for similar establishments in similar locations vary from the requirement. When considering such data, at least twelve (12) consecutive months must be presented with the maximum month of consumption and the days of operation per month being utilized to arrive at the peak flow rate (gpd).

HISTORY: Amended by SCSR 45-5 Doc. No. 4979, eff May 28, 2021.

502. Onsite Wastewater Pump System Standard.

502.1. Pump Tank (General).

(1) The submersible sewage effluent pump(s) must be housed in a properly vented, watertight tank that is readily accessible from the surface.

(2) A watertight access opening with removable lid shall be provided and shall be designed and maintained to prevent surface water inflow. Risers and other pump tank sections, where present, shall be joined using mastic, butyl rubber, or other pliable sealant that is waterproof, corrosion-resistant, and approved for use in septic tanks.

(3) When the pump tank must be located in an area characterized by a shallow zone of saturation, the Department may require the use of a pre-cast manhole, a fiberglass or polyethylene basin, or any other acceptable method for preventing groundwater intrusion.

(4) When the pump tank must be located in an area that is environmentally sensitive or subject to flooding, applicable portions of R.61-67, Standards for Wastewater Facility Construction, shall apply.

(5) The pump tank shall have sufficient capacity to accommodate all level control and alarm switches; to keep the pump(s) totally submersed in liquid at all times and to provide the required

dosing volume and minimum pump run time. Pump tank capacity must be at least 500 gallons in order to provide emergency storage in the event of pump or power failure and to assist in maintaining the minimum pumping rate as listed in Section 502.2.

(6) Pre-engineered, manufactured packaged pump stations can be utilized in lieu of the composite design described herein, provided the pump meets the minimum capacity requirements of the system and no alterations are made to the pump station other than those specifically authorized by the manufacturer.

502.2. Minimum Pumping Rates (Peak Inflow) and Minimum Run Times.

(1) For residential systems, the maximum daily flow entering the pump tank shall be based upon one hundred twenty (120) gpd per bedroom. For commercial and other facilities, this value shall be based upon Section 501, Peak Sewage Flow Rate Standard.

(2) The minimum pumping rate (peak inflow) for discharges up to fifteen hundred (1500) gpd shall be determined as follows:

<u>Maximum Estimated Daily Flow (gpd)</u>	<u>Minimum Pumping Rate (peak inflow) (gpm)</u>
480 and less	10
481-720	15
721-1500	20

(3) The minimum pumping rate (peak inflow) for discharges in excess of fifteen hundred (1500) gpd shall be determined by multiplying the average flow rate (gpm) times a peaking factor of not less than 2.5, where the average flow rate is based upon actual minutes per day of facility operation.

(4) The minimum pump run time for all pump systems shall be determined as follows:

<u>Minimum Pumping Rate (peak inflow) (gpm)</u>	<u>Minimum Pump Run time (min)</u>
10-14	3
15-24	4
25 and above	5

502.3. Minimum Dosing Volume, Scouring Velocity, and Pump Capacity.

(1) The minimum dosing volume (gal) shall be determined by multiplying the minimum pumping rate (gpm) times the minimum pump run time (min).

(2) The selected pump(s) must have the capacity to deliver the minimum pumping rate (gpm) at a scouring velocity of at least one (1) ft/sec (effluent) or two (2) ft/sec (raw) against the total dynamic head of the system. This minimum pump capacity (gpm at total feet of dynamic head) shall be specified on the permit to construct.

(3) Duplex pumps shall be required when the maximum estimated daily flow is equal to or greater than fifteen hundred (1500) gallons, and each pump shall meet the minimum capacity as stated above.

(4) In those cases where the minimum pump capacity or any other system requirements exceed what can be specified through the use of this Standard, the Department shall require the applicant to retain the services of a Registered Professional Engineer licensed in South Carolina.

502.4. Force Main, Valves, and Fittings.

(1) The force main shall be Schedule 40 PVC, and the diameter shall be sufficient to provide a velocity of at least one (1) ft/sec (effluent) or two (2) ft/sec (raw) using a C Factor of one hundred fifty (150) (effluent) or one hundred forty (140) (raw) at the minimum pumping rate (peak inflow). The force main shall be installed a minimum of eight (8) inches below the ground surface. Fittings and valves shall be of compatible corrosion resistant material.

(2) A threaded union, flange, or similar disconnect device shall be provided in each pump discharge line. The pump(s) shall be easily removable at ground surface without requiring entrance into the tank. Valves shall also be readily accessible from the ground surface. Duplex pump systems shall be equipped with a separate pit or box for the placement and operation of valves.

(3) A shutoff valve (e.g., gate valve) and a check valve shall be located on the discharge line from each pump. The check valve shall be placed between the pump and the shutoff valve.

(4) A three-sixteenths (3/16) inch anti-siphon hole(s) shall be placed between the pump(s) and the check valve(s) when the discharge elevation of the distribution system is below the inlet to the pump tank.

(5) In cases where the force main must be installed over undulating terrain, automatic air relief valves shall be placed at high points in the line to prevent air locking.

(6) Exposed force mains crossing ditches and bodies of water (e.g., creeks and wetlands) and force mains under driveways and parking areas must be protected by encasing them within a larger diameter pipe that can withstand potential damage (e.g., galvanized pipe, steel pipe, ductile iron). Force mains under driveways and parking areas may also be protected by encasing them within a larger diameter schedule 80 PVC pipe. The protective piping should extend beyond the area of needed protection for at least ten (10) linear feet.

(7) The force main effluent shall discharge into a separate discharge box or distribution manifold before entering either a septic tank or a soil wastewater infiltration trench. The flow shall be directed to the bottom of the box through a PVC elbow or into a distribution manifold at an angle of ninety (90) degrees to the septic tank or first wastewater infiltration trench.

502.5. Pumps, Control Devices, and Electrical Connections.

(1) Pumps shall be listed by Underwriter's Laboratory or an equivalent third-party testing and listing agency and shall be specifically manufactured for use with domestic wastewater.

(2) Sealed mercury control floats or similar devices designed for detecting liquid levels in septic tank effluent shall be provided to control pump cycles. A separate level sensing device shall be provided to activate an audible and visible high water alarm. Pump-off levels shall be set to keep the pump submerged at all times.

(3) Pump and control circuits shall be provided with manual circuit disconnects within a watertight, corrosion resistant, outside enclosure (NEMA 4X or equivalent) adjacent to the pump tank, securely mounted at least twelve (12) inches above finished grade, unless installed within a weather-tight building. Alarm circuits shall be supplied ahead of any pump overload or short circuit protective devices. The pump(s) shall be manually operable without requiring special tools or entrance into the tank for testing purposes. Conductors shall be conveyed to the disconnect enclosure through water proof, gas proof, and corrosion resistant conduit(s) with no splices or junction boxes provided inside the tank. Wire grips, duct seal, or other suitable material shall be used to seal around wire and wire conduit openings inside the pump tank and disconnect enclosure.

(4) For systems requiring duplex pumps, each pump shall operate in a lead-lag sequence and be on an alternating cycle. A control panel shall be provided which shall include short circuit protection for each pump and for the control system, independent disconnects, automatic pump sequencer, hands-off-automatic (H-O-A) switches, run lights, and elapsed time counters for each pump.

502.6. Final Inspection and Approval.

(1) Before or during final inspection, the property owner or agent shall provide literature, including a pump curve, describing the specific pump installed. The inspector shall evaluate the system in accordance with this Standard, and shall confirm that all items, including the minimum pump capacity specified on the permit to construct, have been satisfied.

(2) Prior to final approval, the installer or electrician shall provide the Department with written documentation verifying that pump system electrical connections were made in accordance with all applicable codes. The Department may require testing of the pump system, demonstration of watertight integrity, or any other procedure deemed necessary to confirm the acceptability of the installation.

502.7. Raw Sewage Pump Stations.

(1) In those cases where it is necessary to pump raw sewage from a residence or facility to an onsite wastewater system, the pump station shall meet all applicable portions of this Standard and R.61-67, Standards for Wastewater Facility Construction.

(2) Adherence to the pump manufacturer's recommendations shall also be a major consideration with such systems.

HISTORY: Amended by State Register Volume 40, Issue No. 5, Doc. No. 4591, eff May 27, 2016. Renumbered from 61-56.600 and amended by SCSR 45-5 Doc. No. 4979, eff May 28, 2021.

503. Minimum Design Standards for Tank Construction.

503.1. Introduction.

The following standards describing tank designs intended to be utilized for septic tanks, grease traps, or pump chambers for onsite wastewater systems have been adopted in an effort to assure a quality product of sufficient strength and resistance, capable of fulfilling its intended purpose.

503.2. Design Approval.

(1) No person shall manufacture tanks intended to be utilized for septic tanks, grease traps, or pump chambers for onsite wastewater systems without receiving approval from the Department. All manufactured tanks must receive approval of design and reinforcement methods prior to manufacturing.

(2) Any person desiring to manufacture tanks shall submit a written application on forms provided by the Department. Such application shall include the name and address, the location of the facility, tank capacity, and design information.

(3) Prior to approval, the Department shall review the tank design, reinforcement, and manufacturing methods to determine compliance.

(4) The Department shall approve plans for manufactured tanks to ensure compliance with the South Carolina Minimum Design Standards for Tank Construction.

(5) The Department shall approve plans for fabricated tanks, other than those for precast reinforced concrete tanks, on an individual basis. Fabricated tanks shall meet the requirements of precast reinforced concrete tanks to provide equivalent effectiveness.

(6) The Department shall issue an approval to the tank manufacturer if the tank design, reinforcement and manufacturing method complies with the South Carolina Minimum Design Standards for Tank Construction. Tank manufacturing approvals are not transferable. When a change of ownership occurs, the new owner shall submit a written application on forms provided by the Department.

(7) The Department shall revoke approval to manufacture tanks for onsite wastewater systems if the tank manufacturer fails to comply with the South Carolina Minimum Design Standards for Tank Construction.

503.3. General.

(1) Septic tanks and grease traps shall be manufactured as single compartment or partitioned tanks.

(2) If septic tanks and grease traps are manufactured with a partition so that the tank contains two (2) compartments, the inlet compartment of the tank shall contain two-thirds (2/3) of the overall capacity, and the outlet compartment shall contain one-third (1/3) of the overall capacity. The top of the partition shall terminate two (2) inches below the bottom side of the tank top in order to leave space for air or gas passage between compartments. The top and bottom halves of the partition shall be constructed in such manner as to leave a four (4) inch water passage at the vertical mid-point of the partition wall for the full width of the tank.

(3) The minimum liquid capacity requirements shall be met by the use of a single septic tank or two (2) or more tanks installed in series. Septic tanks joined in series shall be interconnected by an upper effluent pipe(s) with a minimum diameter of four (4) inches and a lower sludge pipe(s) with a minimum diameter of twelve (12) inches. The upper connection(s) shall be installed level from tank to tank, and the lower sludge pipe connection(s) shall be installed level and shall be placed twelve (12) inches above the bottoms of the tanks. The lower sludge pipe connection(s) can be eliminated if the first tank in series contains at least two-thirds (2/3) of the total required liquid capacity. There shall be no more than two (2) inches of fall from the inlet invert of the first tank to the outlet invert of the last tank in series.

(4) It is required that all pump chambers function as a single compartment tank. If a two (2) compartment tank is used, at least two (2) six (6) inch diameter holes or equivalent, must be provided in the partition wall six (6) inches from the tank bottom.

(5) The septic tank and grease trap tank length shall be at least two (2) but not more than three (3) times the width.

(6) The liquid depth shall not be less than four (4) feet.

(7) A minimum of nine (9) inches of freeboard shall be provided in all tanks, unless otherwise approved by the Department.

(8) Useable liquid capacity for septic tanks or grease traps shall not be less than one thousand (1000) gallons.

(9) The pump tank shall have sufficient capacity to accommodate all level control and alarm switches; to keep the pump(s) totally submersed in liquid at all times and to provide the required dosing volume and minimum pump run time. It is strongly recommended that pump tank capacities be as large as possible in order to provide emergency storage in the event of pump or power failure.

(10) There shall be a minimum of two (2) openings in the tank wall located at the inlet and outlet ends or sides of the inlet and outlet ends of the tank. The knockouts for the inlet and outlet openings of pre-cast concrete tanks shall have a concrete thickness of not less than one (1) inch in the tank wall. The openings shall allow for a minimum of four (4) inch pipe or a maximum of six (6) inch pipe. No openings shall be permitted below the tank liquid level.

(11) The inlet and outlet for septic tanks and grease traps shall be a cast-in-place concrete tee, a polyvinyl chloride (PVC) tee, an acrylonitrile butadiene styrene (ABS), or a polyethylene (PE) tee made of not less than Schedule 40 pipe or equivalent fittings and material. The cast-in-place concrete tees shall have a minimum thickness of not less than two (2) inches. The invert of the outlet shall be at least two (2) inches lower in elevation than the invert of the inlet. The inlet and outlet tees shall extend above liquid level a minimum of six (6) inches and to no less than one (1) inch from the top of the tank to allow venting between tank compartments and multiple tank configurations.

(12) The inlet tee for septic tanks and grease traps shall extend sixteen (16) inches below the liquid level.

(13) The outlet tee for a septic tank shall extend eighteen (18) inches below the liquid level and the outlet tee for a grease trap shall extend between six (6) and twelve (12) inches above the tank bottom.

(14) The inlet, outlet, and wiring conduit openings of all tanks must utilize a resilient, watertight, non-corrosive connective sleeve. The use of grout is prohibited.

(15) Access to each tank or compartment shall be provided by an opening located above the inlet and outlet with an inside dimension of at least eighteen (18) inches square (18 × 18) or in diameter, with removable tank access lids.

(16) Concrete tank access lids shall be equipped with steel lift rings at least three-eighths (3/8) inch diameter or by an alternative method approved by the Department.

(17) Should risers or manholes be utilized to allow access into septic tanks, grease traps, or pump chambers, the risers or manhole covers, as applicable, shall be constructed to prevent the release of odors, entry of vectors, and water. Grade level riser/manhole covers shall be secured by bolts, locking mechanisms, fasteners that can only be removed by tools, or have sufficient weight to prevent unauthorized access. The ground shall slope away from any access extended to grade level.

(18) Risers/manholes shall be sealed to the tank by using bituminous mastic, butyl rubber, or other pliable sealant that is waterproof, corrosion-resistant, and approved for use in tank construction. The sealant shall have a minimum size of one (1) inch diameter or equivalent. The joint shall be smooth, intact, and free of all deleterious substances before sealing.

(19) After curing, all multi-piece tanks shall be joined and sealed at the joints by using a bituminous mastic, butyl rubber, or other pliable sealant that is waterproof, corrosion-resistant, and approved for use in tank construction. The sealant shall have a minimum size of one (1) inch diameter or equivalent. The joint shall be smooth, intact, and free of all deleterious substances before sealing. The use of grout is prohibited.

(20) All concrete tanks must pass the ASTM C-1227 Standard for watertight testing. The Department will choose tanks at random for testing. Tanks will be approved for use in South Carolina after the Department ascertains that the standard is met. After joining, tanks manufactured in multiple sections shall be plastered along the section joints with hydraulic cement or other waterproofing sealant. Other methods of waterproofing tanks may be used as specifically approved in the plans and specifications for the tank. Prior to backfilling, the Department shall make a finding that multiple section tanks are watertight if a soil wetness condition is present within five feet of the elevation of the top of the tank. Any tank found to be improperly sealed, having cracks or holes, which will allow for

water infiltration or discharge of sewage from the tank bottom, walls, or top, will not be approved for use.

(21) Concrete tank manufacturers must have equipment and capabilities for portion control to maintain constant mixture formulation ratios and provide for systematic inspection of finished products to ensure compliance with the minimum tank construction and design standards.

(22) The concrete mix used for concrete tank components must be formulated to yield a minimum twenty-eight (28) day compressive strength of four thousand (4,000) pounds per square inch (psi).

(23) The aggregate size utilized in the concrete mix shall not exceed one-third (1/3) of the wall thickness. Suitable aggregates include sand particle sizes from a fine to one-fourth (1/4) inch gravel or crushed stone. Granite dust or fine screenings from a crusher operation may be used in lieu of sand.

(24) An identifying seal must be cast, molded, or permanently affixed by an approved method from the Department on the outlet tank wall within six (6) inches of the top. The identifying seal shall identify the manufacturer and the liquid capacity of the tank. The concrete tank's cast date shall be located on the identifying seal or imprinted on the top of the tank within six (6) inches from outlet tank wall near the identifying seal. The lettering on the identifying seal or date imprinted on the top of the tank shall be no more than six (6) inches in height.

(25) The tank manufacturer shall guarantee all tanks in writing for two (2) years against failure due to poor workmanship and materials.

(26) Changes in approved tank design, construction, and alternative reinforcing methods will not be allowed without prior approval from the Department.

503.4. Pre-Cast Concrete Non-Fiber Reinforced Septic Tanks and Grease Traps.

(1) The tank walls and bottom shall be reinforced with six by six (6 × 6) inch ten (10) gauge wire mesh.

(2) Tank tops shall be reinforced with six by six (6 × 6) inch ten (10) gauge wire mesh, a minimum of five (5) sections of three-eighths (3/8) inch diameter steel reinforcing bars oriented perpendicular to the tank sidewalls beginning at the center spaced twelve (12) inches apart and four (4) sections of three-eighths (3/8) inch diameter steel reinforcing bars placed diagonally from the corners to the center of the tank. The length of the perpendicular reinforcing bars shall be of sufficient length to extend two (2) inches into the sidewall. The length of the four (4) diagonal steel reinforcing bars shall be of sufficient length to extend two (2) inches into the sidewall and six (6) inches beyond the closest perpendicular steel reinforcing bar.

(3) If a septic tank or grease trap is manufactured with a partition, the tank partition (both halves) shall be reinforced with six by six (6 × 6) inch ten (10) gauge wire mesh. The reinforcing wire shall be bent to form an angle of ninety (90) degrees on the ends in order to form a leg not less than four (4) inches long. When the wire is placed in the mold, the four-inch legs shall lay parallel with the sidewall wire and adjacent to it.

(4) The tank walls and bottom thickness shall be at least two and one-half (2 1/2) inches, and top thickness shall be at least three (3) inches.

(5) All reinforcing wire and rods must be covered by at least one-half (1/2) inch of concrete.

(6) An acceptable vibration method shall be employed in the construction of the tank to prevent voids in the tank walls, bottom, and top.

503.5. Pre-Cast Concrete Fiber Reinforced Septic Tanks and Grease Traps.

(1) Tank tops shall be reinforced with a minimum of five (5) sections of three-eighths (3/8) inch diameter steel reinforcing bars oriented perpendicular to the tank sidewalls beginning at the center spaced twelve (12) inches apart, and four (4) sections of three-eighths (3/8) inch diameter steel reinforcing bars placed diagonally from the corners to the center of the tank. The length of the perpendicular reinforcing bars shall be of sufficient length to extend two (2) inches into the sidewall. The length of the four (4) diagonal steel reinforcing bars shall be of sufficient length to extend two (2) inches into the sidewall and six (6) inches beyond the closest perpendicular steel reinforcing bar.

(2) Tank bottoms shall be reinforced with a minimum of seven (7) sections of three-eighths (3/8) inch diameter steel reinforcing bars oriented perpendicular to the tank sidewalls beginning at the center

spaced twelve (12) inches apart. The length of the perpendicular reinforcing bars shall be of sufficient length to extend two (2) inches into the sidewall.

(3) If a septic tank or grease trap is manufactured with a partition, the tank partition (both halves) shall be reinforced with six by six (6×6) inch ten (10) gauge wire mesh. The reinforcing wire shall be bent to form an angle of ninety (90) degrees on the ends in order to form a leg not less than four (4) inches long. When the wire is placed in the mold, the four-inch legs shall lay parallel with the sidewall wire and adjacent to it.

(4) The tank perimeter walls shall be reinforced with three-eighths ($3/8$) inch diameter steel reinforcing bars located one (1) inch from the tank's top and bottom section seams.

(5) The tank walls and bottom thickness shall be at least two and one-half ($2 \frac{1}{2}$) inches, and top thickness shall be at least three (3) inches.

(6) All reinforcing wire and rods must be covered by at least one-half ($1/2$) inch of concrete.

(7) Fiber products used with this reinforcement design must be added during the mixing process in order to achieve even distribution throughout the concrete mixture.

(8) Fiber length must range from at least one (1) to no more than two (2) inches.

(9) The fiber must be specifically manufactured for use as a concrete secondary reinforcement and be a polypropylene fibrillated (two-dimensional fiber mesh network) material.

(10) An acceptable vibration method shall be employed in the construction of the tank to prevent voids in the tank walls, bottom, and top.

503.6. Concrete Block Septic Tanks and Grease Traps.

(1) The tank walls and partition thickness shall be at least eight (8) inches and the top cover slabs thickness shall be at least four (4) inches.

(2) The tank bottom shall be a single pour concrete slab to a depth of at least four (4) inches within the first block course.

(3) If a septic tank or grease trap is manufactured with a partition, the tank walls and partition shall be constructed of solid sixteen by eight by eight ($16 \times 8 \times 8$) inch concrete blocks. The use of hollow blocks is prohibited.

(4) All joints between concrete blocks shall be mortared using masonry cement mortar or equivalent. The joints shall have a nominal thickness of three-eighths ($3/8$) inch.

(5) The upper partition wall may be supported by the use of two by four by eight ($2 \times 4 \times 8$) inch bricks (or equivalent support material) standing on edge located at the block seams of the upper partition wall.

(6) The top cover slabs shall be constructed such that the individual slabs will not exceed two (2) feet in width and the length will be sufficient to extend to the outside tank width with a minimum slab thickness of four (4) inches.

(7) The individual top cover slabs shall be reinforced with a minimum of two (2) sections of three-eighths ($3/8$) inch diameter steel reinforcing bars oriented perpendicular to the tank sidewalls spaced twelve (12) inches apart from the center. The length of the perpendicular reinforcing bars shall be of sufficient length to extend the full length of the slab.

(8) The end cover slabs shall be constructed such that the individual slabs will not exceed three (3) feet in width and the length will be sufficient to extend to the outside tank width with a minimum slab thickness of four (4) inches.

(9) The end cover slabs shall be cast to allow access to each tank or compartment by providing an opening located above the inlet and outlet tee with an inside dimension of eighteen (18) inches square (18×18 inches) or in diameter with removable tank access lids.

(10) The individual end cover slabs shall be reinforced with two (2) sections of three-eighths ($3/8$) inch diameter steel reinforcing bars oriented perpendicular to the tank sidewalls spaced twelve (12) inches apart from the center and two (2) sections of three-eighths ($3/8$) inch diameter steel reinforcing bars oriented perpendicular to the tank sidewalls spaced sixteen (16) inches apart from the center. The length of the perpendicular reinforcing bars shall be of sufficient length to extend the full length of the slab.

(11) The top and end cover slab seams shall be sealed to the tank walls and at all joints by using a bituminous mastic, butyl rubber, or other pliable sealant that is waterproof, corrosion-resistant, and approved for use in septic tanks. The sealant shall have a minimum size of one (1) inch diameter or equivalent. The use of grout is prohibited.

(12) The tank top and end cover slabs shall be equipped with steel lift handles at least one half (1/2) inch diameter, or by an alternative method approved by the Department.

(13) All reinforcing rods must be covered by at least one-half (1/2) inch of concrete.

(14) The interior of the tank (walls and bottom) shall be plastered with a waterproofing cement compound.

(15) An acceptable vibration method shall be employed in the construction of the tank to prevent voids in the tank access lids, tank bottom, and top and end slabs.

503.7. Pre-Cast Concrete Non-Fiber Reinforced Pump Chambers.

(1) The tank walls and bottom shall be reinforced with six by six (6 × 6) inch ten (10) gauge wire mesh.

(2) Tank tops shall be reinforced with six by six (6 × 6) inch ten (10) gauge wire mesh, a minimum of five (5) sections of three-eighths (3/8) inch diameter steel reinforcing bars oriented perpendicular to the tank sidewalls beginning at the center spaced twelve (12) inches apart, and four (4) sections of three-eighths (3/8) inch diameter steel reinforcing bars placed diagonally from the corners to the center of the tank. The length of the perpendicular reinforcing bars shall be of sufficient length to extend two (2) inches into the sidewall. The length of the four (4) diagonal steel reinforcing bars shall be of sufficient length to extend two (2) inches into the sidewall and six (6) inches beyond the closest perpendicular steel reinforcing bar.

(3) The tank walls and bottom thickness shall be at least two and one-half (2 1/2) inches, and top thickness shall be at least three (3) inches.

(4) All reinforcing wire and rods must be covered by at least one-half (1/2) inch of concrete.

(5) An acceptable vibration method shall be employed in the construction of the tank to prevent voids in the tank walls, bottom, and top.

503.8. Pre-Cast Concrete Fiber Reinforced Pump Chambers.

(1) Tank tops shall be reinforced with a minimum of five (5) sections of three-eighths (3/8) inch diameter steel reinforcing bars oriented perpendicular to the tank sidewalls beginning at the center spaced twelve (12) inches apart and four (4) sections of three-eighths (3/8) inch diameter steel reinforcing bars placed diagonally from the corners to the center of the tank. The length of the perpendicular reinforcing bars shall be of sufficient length to extend two (2) inches into the sidewall. The length of the four (4) diagonal steel reinforcing bars shall be of sufficient length to extend two (2) inches into the sidewall and six (6) inches beyond the closest perpendicular steel reinforcing bar.

(2) Tank bottoms shall be reinforced with a minimum of seven (7) sections of three-eighths (3/8) inch diameter steel reinforcing bars oriented perpendicular to the tank sidewalls beginning at the center spaced twelve (12) inches apart. The length of the perpendicular reinforcing bars shall be of sufficient length to extend two (2) inches into the sidewall.

(3) The tank perimeter walls shall be reinforced with three-eighths (3/8) inch diameter steel reinforcing bars located one (1) inch from the tank's top and bottom section seams.

(4) The tank walls and bottom thickness shall be at least two and one-half (2 1/2) inches, and top thickness shall be at least three (3) inches.

(5) All reinforcing wire and rods must be covered by at least one-half (1/2) inch of concrete.

(6) Fiber products used with this reinforcement design must be added during the mixing process in order to achieve even distribution throughout the concrete mixture.

(7) Fiber length must range from at least one (1) to no more than two (2) inches.

(8) The fiber must be specifically manufactured for use as a concrete secondary reinforcement and be a polypropylene fibrillated (two-dimensional fiber mesh network) material.

(9) An acceptable vibration method shall be employed in the construction of the tank to prevent voids in the tank walls, bottom, and top.

HISTORY: Renumbered from 61-56.700 and amended by SCSR 45-5 Doc. No. 4979, eff May 28, 2021.

504. Fiberglass Reinforced Plastic Tanks Standard.

Standards describing fiberglass reinforced plastic septic tanks have been adopted to ensure a quality product of sufficient strength and resistance, capable of fulfilling its intended purpose. Many of these standards were derived from NBS Voluntary Product Standard PS 15-69, which covers custom contact-molded reinforced polyester chemical resistant process equipment.

504.1. General Requirements.

The following general requirements are applicable to fiberglass reinforced plastic septic tanks as defined within this regulation, and approved design standards and structural properties of the same shall be not less than those stated.

(1) Material

Resins and sealants used in the tank manufacturing process shall be capable of effectively resisting corrosive influences of liquid components of sewage, gases generated by the digestion of sewage, and soil burial. Materials used shall be formulated to withstand vibration, shock, normal household chemicals, earth, and hydrostatic pressure both when full and empty. Not less than thirty (30) percent of the total weight of the tank shall be fiberglass reinforcement. For tanks not exceeding a fifteen hundred (1500) gallon liquid capacity, the minimum wall thickness shall be three-sixteenths (3/16) inch, provided, however, that isolated small spots may be as thin as eighty (80) percent of the minimum.

(2) Inner Coating

Internal surfaces shall be coated with an appropriate gel coating to provide a smooth, pore-free, watertight surface for fiberglass reinforced plastic parts.

(3) Physical Properties

Tanks shall be so constructed that all parts of the tank shall meet the following requirements:

(a) Ultimate Tensile Strength (Minimum) - Nine thousand (9,000) pounds per square inch (psi) when tested in accordance with ASTM D 638-71a, Standard Method of Test for Tensile Properties of Plastics.

(b) Flexural Strength (Minimum) - Sixteen thousand (16,000) psi when tested in accordance with ASTM D 790-71, Standard Method of Test for Flexural Properties of Plastics.

(c) Flexural Modulus of Elasticity Tangent (Minimum) - Seven hundred thousand (700,000) psi when tested in accordance with ASTM D 790-71, Standard Method of Test for Flexural Properties of Plastics.

(4) Watertight Integrity

Tanks shall be so constructed as to be watertight for the designed life of the tank. Lids or covers shall be sufficiently tight when installed to preclude the entrance of surface or ground water into the tank.

(5) Longevity

Proof from an independent testing laboratory shall be submitted substantiating a minimum life expectancy of twenty years of service for the intended use of the tank and appurtenant components such as necessary sealants, connective fastenings, resins, etc.

(6) Safety

As a safety measure, provisions shall be made in the construction of septic tank lids or covers to preclude unauthorized entry or removal when the use of the tank necessitates positioning of access openings at or above ground level.

(7) Workmanship

Tanks shall be of uniform thickness and free from defects that may affect their serviceability or durability. Completed tanks shall have a smooth inside finish free of spills, pits, and honeycombs. Plant quality control shall be sufficient to maintain a high degree of uniformity in tank quality.

504.2. Specific Requirements.

Specific requirements for design and construction shall be not less than those specified herein and shall be in conformity with recognized National Standards for design and construction and in accordance with this regulation.

504.3. Capacity and Design Limits.

(1) Dimensions

(a) The inside length of a horizontal cylindrical tank shall be at least two (2) but not more than three (3) times the width.

(b) The uniform liquid depth shall not be less than four (4) feet.

(c) At least fifteen (15) percent of the total volume of the tank shall be above the liquid level.

(d) If tanks of other shapes are proposed, specifications must be submitted to the Department for approval.

(2) Inlet

(a) Provisions shall be made for the building sewer to enter the center of one end of the septic tank two (2) inches above the normal liquid level of the tank.

(b) A tee shall be constructed as an integral part of the tank to receive the building sewer, or as an alternative, an integrally constructed baffle may be used.

(c) If baffles are used, suitable integrally fitted sleeves or collars shall be provided in the inlet openings of the tank to provide surface areas sufficient to ensure capability of watertight bonding between the tank and the inlet sewer.

(d) If the tee or baffle is constructed of plastic material, it shall meet NSF Standard #14 for drain, waste, and vent system application.

(e) If fiberglass reinforced plastic is used, it shall be of the same constituency as material of which the tank is constructed.

(f) The inlet tee or baffle shall extend sixteen (16) inches below the designed liquid level and be placed and secured in a vertical position so as to be watertight and preclude dislodgement during installation, operation, or maintenance activities.

(3) Outlet

(a) Provisions shall be made for the outlet sewer to receive the discharge from the tank by providing an opening in the center of the end of the tank opposite the inlet, the invert elevation of which shall be at the liquid level of the tank.

(b) A tee shall be constructed as an integral part of the tank to connect to the outlet sewer or, as an alternative, an integrally constructed baffle may be used.

(c) If baffles are used, suitable integrally fitted sleeves or collars shall be provided in the outlet opening of the tank to provide surface areas sufficient to ensure capability of watertight bonding between the tank and the outlet sewer.

(d) If the tee or baffle is constructed of plastic material, it shall meet NSF Standard #14 for drain, waste, and vent system application.

(e) If fiberglass reinforced plastic is used, it shall be of the same constituency as material of which the tank is constructed.

(f) The outlet tee or baffle shall extend eighteen inches below the design liquid level and be placed and secured in a vertical position so as to be watertight and preclude dislodgement during installation, operation, or maintenance activities.

(g) The inlet and outlet tees shall extend above liquid level a minimum of six (6) inches and to no less than one (1) inch from the top of the tank to allow venting between tank compartments and multiple tank configurations.

(4) Access Openings

Openings in the top of the septic tank shall be provided over the inlet and outlet tees or baffles with sufficient area to enable maintenance service to such tees or baffles.

(5) Identifying Markings

Fiberglass septic tanks shall be provided with a suitable legend, cast or stamped into the wall at the outlet end, and within six inches of the top of the tank, identifying the manufacturer, and indicating the liquid capacity of the tank in gallons.

HISTORY: Renumbered from 61-56.800 and amended by SCSR 45-5 Doc. No. 4979, eff May 28, 2021.

505. Thermoplastic Tanks Standard.

(1) The Department shall approve plans for thermoplastic tanks on an individual basis.

(a) Thermoplastic tanks shall be certified by an American National Standards Institute or Standards Council of Canada accredited third-party to comply with the most recent edition of IAPMO/ANSI Z1000 or CSA B66.

(b) The uniform liquid depth shall be at least three (3) feet.

(c) The inside length of the tank shall be at least two (2) times the inside width of the tank.

(2) If thermoplastic tanks having other dimensional characteristics are proposed, specifications must be submitted to the Department for approval, and the proposed design must be demonstrated to provide equivalent effectiveness for storage and distribution to that of concrete or thermoplastic tanks described in this regulation.

(3) Thermoplastic tank manufacturers must renew their product approvals by submitting new applications and plans to the Department every five (5) years and before changing any previously approved plans.

HISTORY: Added by State Register Volume 40, Issue No. 5, Doc. No. 4591, eff May 27, 2016. Renumbered from 61-56.900 and amended by SCSR 45-5 Doc. No. 4979, eff May 28, 2021.

600. License to Clean Onsite Wastewater Systems, Self-Contained Toilets, and Other Sewage Holding Systems (i.e., Licensing of Pumper/Haulers).

600.1. No person shall be responsible for the cleaning of onsite wastewater systems, self-contained toilets, and other sewage holding systems in South Carolina without first applying for, receiving, and subsequently maintaining a valid license to conduct such activities as herein required by the Department. This includes, but is not limited to, nonwater-carried sewage treatment devices and gray water subsurface reuse system.

600.2. Licenses, Applications, and Fees.

(1) License applications, on forms approved by the Department, shall be submitted to the Department's regional environmental office which covers the county where the applicant's primary place of business is located; persons whose primary place of business is out of state must submit their applications to the Department's regional environmental office where it is reasonably anticipated the bulk of the activities sought to be licensed would occur.

(2) The following shall apply to applications submitted by persons engaged in the business of cleaning onsite wastewater systems, self-contained toilets, and other sewage holding systems:

(a) The applicant shall list on the application form each approved septage and sewage disposal facility they intend to use. Written verification of permission to use each disposal facility shall accompany the application.

(b) The applicant shall list on the application form all locations where pumping and transporting vehicles are parked/stored when not in use.

(c) For each annual renewal of an existing license, the person seeking renewal shall submit changes to any information included on the original license application to the Department through an updated application.

(d) Upon request by the Department, each person seeking a new license or renewal of an existing license shall make available for inspection all vehicles and equipment used in the pumping and transporting of septage and sewage.

(e) Additional inspections of vehicles and equipment may be conducted by the Department to ensure compliance with this regulation.

(f) If a licensee replaces, deletes, or adds to their inventory of vehicles used in pumping and transporting septage or sewage, the licensee shall immediately notify the Department for the

purpose of updating their application. A vehicle may not be placed into use without prior inspection and approval from the Department.

(3) Prior to receipt of a license authorizing a person to be responsible for the cleaning of onsite wastewater systems, self-contained toilets, and other sewage holding systems, applicants shall complete an examination demonstrating their knowledge and comprehension of this regulation. Any applicant failing to satisfactorily complete the licensing examination may be eligible to retake the examination after thirty (30) calendar days. Applicants who fail to satisfactorily complete their second examination may then be allowed to retake subsequent examinations after a sixty (60)-day waiting period.

(4) A fee shall be assessed for a new license and for the annual renewal of a license.

(a) No person who seeks to be responsible for the cleaning of onsite wastewater systems, self-contained toilets, and other sewage holding systems shall be issued a new license pursuant to this regulation until a fee of one hundred dollars (\$100.00) has been paid to the Department, except that a person applying both for this license (i.e., pumper/hauler license) and an installers license (i.e., license to construct or repair systems) shall pay a fee of only fifty dollars (\$50.00) for the license to clean onsite wastewater systems, self-contained toilets, and other sewage holding systems.

(b) Every license issued by the Department under this regulation shall be valid for a period of one (1) year, unless otherwise suspended or revoked.

(c) Each licensee must pay an annual renewal fee of one hundred dollars (\$100.00), except that a person applying to renew both this license (i.e., pumper/hauler license) and an installers license (i.e., license to construct or repair systems) shall pay a fee of only fifty dollars (\$50.00) for the renewal of the license to clean onsite wastewater systems, self-contained toilets, and other sewage holding systems.

(d) Annual renewal fees shall be due on a date not less than thirty (30) calendar days from the billing date. A penalty charge of thirty dollars (\$30.00) shall be assessed for license fees that are past due. A second penalty of thirty dollars (\$30.00) shall be assessed for license fees sixty (60) days past due.

(e) Expiration of a license shall occur when the license fee is ninety (90) calendar days past due. No person with an expired license may be engaged in the business of cleaning onsite wastewater systems, self-contained toilets, and other sewage holding systems.

(f) An expired license shall not be renewed. Any person with an expired license may apply for a new license and must meet all applicable requirements for a new license.

(5) Licenses issued in accordance with this regulation shall not be transferable.

600.3. Further Governmental Restriction Not Prohibited.

Nothing within this regulation shall be construed to limit the power of any municipal, county, or governmental entity to enforce other license requirements or additional measures for the restrictions of persons cleaning onsite wastewater systems, self-contained toilets, and other sewage holding systems.

600.4. License Not Required.

Public or private sewer providers using pumping and transporting vehicles for the sole purpose of maintaining their sewer systems shall be exempt from the licensing requirements of Section 600 of this regulation. This exemption does not apply to public or private sewer providers using pumping and transporting vehicles to provide cleaning services to the public.

HISTORY: Added by SCSR 45-5 Doc. No. 4979, eff May 28, 2021.

601. Vehicles, Equipment, and Practices.

601.1. All vehicles and equipment used to remove and transport septage and sewage shall be maintained in a manner that will prevent the occurrence of leaks, spills, and other nuisance conditions. All vehicles shall be properly identified.

(1) Hoses, valves, tanks, and other equipment must be maintained in good repair and working order.

(2) All vehicles used to transport septage and sewage must bear the company name and license number in a prominent place on the sides and rear of each vehicle, using letters and numbers that are at least four (4) inches in height.

601.2. The cleaning of septic tanks and similar units and the pumping and transporting of septage and sewage shall be done in a manner that is safe and does not create a hazard to the public health and the environment. The proper cleaning of any septic tank or similar unit shall include the substantial removal of its contents (solids, semi-solids, and liquids).

601.3. Disposal of septage and sewage shall be allowed only at facilities approved by the Department. A licensee may dispose of septage and sewage only at those approved facilities designated by the licensee's application and any renewals or updates of the application.

(1) Discharge of septage and sewage shall be allowed only at those specific locations designated by the owners/operators of approved disposal facilities.

(2) Discharge of septage and sewage into a public sewage collection system, without the consent and permission of the owner/operator of such system, is prohibited.

(3) The storage of domestic wastewater, sewage, or septage in underground or partially buried tanks/subsurface containment units, is prohibited.

601.4. A licensee shall adequately supervise employees and ensure that onsite wastewater systems, self-contained toilets, and other sewage holding systems are cleaned in accordance with this regulation and other applicable regulations, permits, and standards issued by the Department.

HISTORY: Added by SCSR 45-5 Doc. No. 4979, eff May 28, 2021.

602. Records of Operation.

602.1. Each person licensed to clean onsite wastewater systems, self-contained toilets, and other sewage holding systems is required to maintain accurate records of cleaning and transporting activities.

(1) Records shall be kept current and shall include at least the following information for each cleaning/transporting activity:

(a) Date and time of septage and sewage removal.

(b) Name and address of residence or facility where septage and sewage was removed. Where one or more self-contained toilets are cleaned at one location (e.g., construction site, special event, etc.), one recorded entry per location will be acceptable.

(c) Quantity and type of septage and sewage removed (e.g., grease trap, septic tank, self-contained toilet, etc.). Where one or more self-contained toilets are cleaned at one location, quantity may be expressed by the total number of units cleaned at that location.

(d) Date, time, and location of septage and sewage disposal.

602.2. Records shall be made available for inspection by the Department upon request. All licensees must retain their records for a minimum of two (2) years.

HISTORY: Added by SCSR 45-5 Doc. No. 4979, eff May 28, 2021.

700. License to Construct or Repair Onsite Wastewater Systems (i.e. Licensing of Installers).

700.1. License Requirements and Fees.

(1) No person shall be responsible for the construction or repair of onsite wastewater systems in South Carolina without first applying for, receiving, and subsequently maintaining a valid license to conduct such activities as herein required by the Department, provided that a person may construct or repair an onsite wastewater system for personal use at the person's residence without obtaining a license.

(2) Licenses, Applications, and Fees

(a) License applications, on forms approved by the Department, shall be submitted to the Department's regional environmental office which covers the county where the applicant's primary place of business is located; persons whose primary place of business is out of state must submit their applications to the Department's regional environmental office where it is reasonably anticipated the bulk of the activities sought to be licensed would occur.

(b) Prior to receipt of a license authorizing a person to be responsible for the construction or repair of an onsite wastewater system, the applicant shall complete an examination demonstrating the applicant's knowledge and comprehension of this regulation. Any applicant failing to satisfactorily

ly complete the licensing examination may be eligible to retake the examination after thirty (30) calendar days. Applicants who fail to satisfactorily complete their second examination may then be allowed to retake subsequent examinations after a sixty (60) calendar day waiting period.

(c) Each license requires fees for the initial license issuance and annual renewal. The required fees vary depending on the tier of licensure sought. The required initial license and renewal fees for each tier are as follows:

- (i) Tier 1 - One hundred dollar (\$100.00) fee
- (ii) Tier 2 - One hundred dollar (\$100.00) fee
- (iii) Tier 3 - Two hundred dollar (\$200.00) fee

(d) Every license issued by the Department under this regulation shall be valid for a period of one (1) year, unless otherwise suspended or revoked.

(e) Renewal fees shall be due on a date not less than thirty (30) calendar days from the billing date. A penalty charge of thirty dollars (\$30.00) shall be assessed for license fees that are past due. A second penalty of thirty dollars (\$30.00) shall be assessed for license fees sixty (60) days past due.

(f) Expiration of a license shall occur when the license fee is ninety (90) calendar days past due. No person with an expired license may be engaged in the business of constructing and repairing onsite wastewater systems, sewage holding systems, or self-contained toilets.

(g) An expired license shall not be renewed. Any person with an expired license may apply for a new license and must meet all applicable requirements for a new license.

(h) Licenses issued in accordance with this regulation shall not be transferable.

(3) Further Governmental Restriction Not Prohibited

Nothing within this regulation shall be construed to limit the power of any municipal, county, or governmental entity to enforce other license requirements or additional measures for the restrictions of persons constructing or repairing onsite wastewater systems.

(4) Eligibility

Only a person who meets the following criteria is eligible to be licensed as an onsite wastewater systems installer:

(a) Applicants to be a Tier 1 or Tier 2 installer must:

- (i) Pass an examination administered by the Department with a minimum score of eighty (80) percent; and
- (ii) Submit a properly completed application with supporting documents including proof of continuing education units (CEUs) for any renewal; and
- (iii) Pay applicable fees.

(b) Applicants to be a Tier 3 installer must:

- (i) Qualify as either:
 - (A) A licensed onsite wastewater system installer who has been actively installing for three (3) years immediately preceding the date of application with no pending or prior disciplinary or enforcement action involving onsite wastewater system contracting; or
 - (B) An onsite wastewater system installer licensee from another state with affidavits from the regulatory authority demonstrating five (5) years of experience with no pending or prior disciplinary or enforcement action involving onsite wastewater system contracting; and
- (ii) Pass an examination administered by the Department with a minimum score of eighty (80) percent;
- (iii) Submit a properly completed application with supporting documents (if required);
- (iv) Submit proof of continuing education units (CEUs) for any renewal;
- (v) Submit proof of required Bond and insurance coverage; and
- (vi) Pay applicable fees.

HISTORY: Added by SCSR 45-5 Doc. No. 4979, eff May 28, 2021.

701. Continuing Education and Training.

701.1. All installers are required to complete the necessary number of continuing education units (CEUs) every two (2) years from the date of licensing to renew the installer license. CEUs must be obtained from the Department-approved list of courses and providers.

701.2. The Department will not renew a license for any installer who has failed to meet the training and education requirements for the previous licensing period.

701.3. If any installer completes more than the required hours in a licensing period, as many as three (3) hours can be rolled over and credited to the requirement for the next licensing period.

701.4. The required CEUs for each Tier for every two (2) year licensing period are as follows:

- (1) Tier 1: Eight (8) hours
- (2) Tier 2: Twelve (12) hours
- (3) Tier 3: Eighteen (18) hours

701.5. Implementation of CEU Requirement.

The requirement for CEUs will enter into effect for any initial or renewal licensing period beginning on or after the date three (3) years following the effective date of this regulation.

HISTORY: Added by SCSR 45-5 Doc. No. 4979, eff May 28, 2021.

702. Practice, Procedure, and Quality Control.

702.1. Practices: All Installers.

(1) A licensee shall adequately supervise employees and ensure that all onsite wastewater systems for which the licensee is responsible are constructed and repaired in accordance with this regulation and other applicable regulations, permits, and standards issued by the Department. Onsite wastewater systems must be installed pursuant to and in compliance with permits to construct issued by the Department.

(2) An installer does not have the authority to make any changes to a construction or repair project that deviate from an issued permit without first obtaining Department approval.

(3) Installers do not have the authority to subcontract unlicensed installers to conduct work under their licenses.

(4) The specific scope of activities authorized under each tier of licensure is set forth in this regulation's definition of "licensed onsite wastewater system installer." A licensed installer is prohibited from performing any construction or repair that is inconsistent with the scope of activities authorized under the licensee's applicable tier.

702.2. Onsite Wastewater System Installer Self-Inspections.

(1) All Tier 3 installers and Tier 1 or Tier 2 installers directed to perform self-inspections under Section 104.3(1)(c) shall provide the Department the opportunity to perform a final inspection and shall arrange with the Department in advance a time for the final inspection of an onsite wastewater system that is being installed. If, after thirty (30) minutes of that arranged time, the Department representative has not arrived for the inspection, the installer shall:

- (a) Inspect the system;
- (b) Record the findings on a form approved by the Department; and
- (c) Cover the system.

(2) It shall be considered a violation of this regulation to conduct a self-inspection of a system or cover a system without first scheduling a final inspection time with the Department and waiting the full thirty (30) minutes of the arranged time for the Department to conduct a final inspection.

(3) The installer shall not cover a system or seek Department final approval for a system that, upon inspection, is determined not to be in compliance with the permit to construct.

(4) Documentation of system installation and self-inspection using the Department-approved format, including the installer's signature and license number, as well as the system measurements and other specified information, shall be submitted to the Department within two (2) business days of the final self-inspection date. A copy of this document(s) must also be furnished to the property owner for

whom the system was installed. Failure to submit to the Department the required documentation within the required timeframe shall be considered a violation of this regulation.

(5) An onsite wastewater system shall not be placed into operation unless and until the Department has issued a final approval to operate.

702.3. Quality Control: Installers.

The Department will conduct random final inspections on no less than three (3) percent annually of the total number of systems installed during the preceding fiscal year. The Department will also conduct field reviews of final installation and inspection documentation submitted by the installer and compare them to the actual installations those documents represent.

HISTORY: Added by SCSR 45-5 Doc. No. 4979, eff May 28, 2021.

703. Bonding and Insurance Requirements: Tier 3 Installers.

703.1. Proof of both insurance and bond coverage shall be furnished to the Department prior to licensure as a Tier 3 installer and upon license renewal.

703.2. An onsite wastewater system Tier 3 installer shall be responsible for obtaining and maintaining both insurance and bond coverage for as long as the installer is licensed as a Tier 3 installer.

703.3. Failure to maintain both insurance and bond coverage shall result in the suspension or revocation of the Tier 3 installer license.

HISTORY: Added by SCSR 45-5 Doc. No. 4979, eff May 28, 2021.

704. Transition to Tiered Licensure.

Upon the effective date of the tiered licensure provisions (Section 700) of this regulation, all installers licensed as master contractors under the previous R.61-56.2 shall be considered to hold a Tier 3 license, and all other installers licensed under the previous R.61-56.1 shall be considered to hold a Tier 2 license. The Tier 3 or Tier 2 license shall expire upon the original expiration date of the license held under R.61-56.1 or R.61-56.2, as applicable, unless the license is renewed in accordance with the provisions of Section 700.1 of this regulation.

HISTORY: Added by SCSR 45-5 Doc. No. 4979, eff May 28, 2021.

800. Enforcement.

800.1. Violations of this regulation shall be punishable in accordance with S.C. Code Sections 44-1-150, 44-55-825, 48-1-320, and 48-1-330. The Department may seek enforcement, suspend and revoke permits and licenses, issue civil penalties, and order corrective action in accordance with law. The Department shall have the authority to suspend civil penalties if the violations of this regulation are corrected in a period of time established by the Department.

800.2. Deviation from the installation design and conditions in onsite wastewater permits to construct and approvals to operate may be considered a violation of this regulation.

800.3. Suspension and revocation of permits to construct and approvals to operate an onsite wastewater system, nonwater-carried sewage treatment system, wastewater combustion system, or gray water subsurface reuse system.

(1) The Department may temporarily suspend a permit to construct or approval to operate for a violation of this regulation.

(2) The Department may revoke a permit to construct or approval to operate for a violation of this regulation. The Department will revoke a permit or approval when:

(a) The onsite wastewater system, nonwater-carried sewage treatment system, wastewater combustion system, or gray water subsurface reuse system is malfunctioning and sewage is discharging to the ground or the groundwater, the holder of the permit has received notice that the system is malfunctioning, the Department has given notice that repairs must be made within a reasonable period of time, the holder of the permit has not made the repairs, and the system continues to discharge sewage to the ground or the groundwater; or

(b) The onsite wastewater system, nonwater-carried sewage treatment system, wastewater combustion system, or gray water subsurface reuse system is malfunctioning and sewage is discharging to the ground or the groundwater, the holder of the permit has received notice that the system is

malfunctioning, the Department has given notice that a wastewater treatment facility is accessible for connection.

800.4. Enforcement against persons licensed to construct, clean, and/or repair onsite wastewater systems.

(1) A licensee shall be subject to suspension, revocation, and civil penalties as provided in Sections 800.1 and 800.4(2) for the construction, cleaning, or repair of onsite wastewater systems, self-contained toilets, and other sewage holding systems in violation of state laws, regulations, and standards. In determining whether a license should be suspended or revoked, the Department may consider such factors as the seriousness of a violation and whether a violation is a repeat of previous violations, among any other relevant factors. The interference by a licensee or their employees with a representative of the Department in performing their duties with respect to this regulation shall constitute grounds for revocation of license.

(2) Violation of an onsite wastewater system installation permit or any provisions of this regulation by a licensed onsite wastewater system installer or person licensed to clean onsite wastewater systems must be enforced as follows:

(a) First offense violations may be enforced under S.C. Code Section 44-1-150 or by suspension of the license for a period not to exceed one (1) year.

(b) Second offense violations shall be enforced under S.C. Code Section 44-1-150 or by suspension of the license for a period not to exceed three (3) years.

(c) Third offense violations shall be enforced under S.C. Code Section 44-1-150 or by permanent revocation of the license.

(3) The Department may suspend licenses for failure to pay a civil penalty required pursuant to a Department order.

800.5. Prior to suspending or revoking a permit to construct, approval to operate, or license, the Department shall provide written notification to the person stating the basis for suspension or revocation. A permit to construct, approval to operate, or license may be summarily suspended by the Department without prior warning if the Department determines there is an immediate threat to public health.

HISTORY: Added by SCSR 45-5 Doc. No. 4979, eff May 28, 2021.

801. Severability Clause.

Should any section, paragraph, sentence, clause, or phrase of this regulation be declared unconstitutional or invalid for any reason, the remainder of this regulation shall not be affected thereby.

HISTORY: Added by SCSR 45-5 Doc. No. 4979, eff May 28, 2021.

900. Transferred.

HISTORY: Former Regulation, titled Appendix V - Thermoplastic Tanks Standard, had the following history: Added by State Register Volume 40, Issue No. 5, Doc. No. 4591, eff May 27, 2016. Transferred by SCSR 45-5 Doc. No. 4979, eff May 28, 2021. See, now S.C. CODE REGS. 61-56.505.

61-56.1. Repealed.

HISTORY: Former Regulation, titled License to Construct or Clean Onsite Sewage Treatment and Disposal Systems and Self-Contained Toilets, had the following history: Amended by State Register Volume 18, Issue No. 5, eff May 27, 1994. Repealed by SCSR 45-5 Doc. No. 4979, eff May 28, 2021.

61-56.2. LICENSING OF ONSITE WASTEWATER SYSTEM MASTER CONTRACTORS. [REPEALED]

Editor's Note

The following constitutes the history for 61-56.2, 100 through 900.

HISTORY: Added by State Register Volume 33, Issue No. 6, eff June 26, 2009.

CONTENTS

100. PURPOSE

200. DEFINITIONS

300. ELIGIBILITY

- 400. CONTINUING EDUCATION AND TRAINING
- 500. PRACTICE, PROCEDURE AND QUALITY CONTROL
- 600. BONDING AND INSURANCE REQUIREMENTS
- 700. APPLICATION AND LICENSE FEES
- 800. ENFORCEMENT
- 900. SEVERABILITY CLAUSE

100. Repealed.

HISTORY: Former Regulation, titled Purpose, repealed by SCSR 45-5 Doc. No. 4979, eff May 28, 2021.

200. Repealed.

HISTORY: Former Regulation, titled Definitions, repealed by SCSR 45-5 Doc. No. 4979, eff May 28, 2021.

300. Repealed.

HISTORY: Former Regulation, titled Eligibility, repealed by SCSR 45-5 Doc. No. 4979, eff May 28, 2021.

400. Repealed.

HISTORY: Former Regulation, titled Continuing Education and Training, repealed by SCSR 45-5 Doc. No. 4979, eff May 28, 2021.

500. Repealed.

HISTORY: Former Regulation, titled Practice, Procedure and Quality Control, repealed by SCSR 45-5 Doc. No. 4979, eff May 28, 2021.

600. Repealed.

HISTORY: Former Regulation, titled Bonding and Insurance Requirements, repealed by SCSR 45-5 Doc. No. 4979, eff May 28, 2021.

700. Repealed.

HISTORY: Former Regulation, titled Application and License Fees, repealed by SCSR 45-5 Doc. No. 4979, eff May 28, 2021.

800. Repealed.

HISTORY: Former Regulation, titled Enforcement, repealed by SCSR 45-5 Doc. No. 4979, eff May 28, 2021.

900. Repealed.

HISTORY: Former Regulation, titled Severability Clause, repealed by SCSR 45-5 Doc. No. 4979, eff May 28, 2021.

61-57. Repealed.

HISTORY: Former Regulation, titled Development of Subdivision Water Supply and Sewage Treatment/Disposal Systems, had the following history: Amended by State Register Volume 24, Issue No. 2, eff February 25, 2000; State Register Volume 28, Issue No. 4, eff April 23, 2004. Repealed by State Register Volume 40, Issue No. 5, Doc. No. 4549, eff May 27, 2016.

61-58. State Primary Drinking Water Regulations.

(Statutory Authority: 1976 Code §§ 44-55-10 et seq.)

Table of Contents

- 58.A. General
- 58.B. Definitions
- 58.C. Appeals
- 58.D. Severability

58.E. Violations and Penalties

A. General

Regulations 61–58 through 61–58.17 are promulgated pursuant to S.C. Code Sections 44–55–10 et seq. and are collectively known as the State Primary Drinking Water Regulations. The Department finds the standards and procedures prescribed are necessary to maintain reasonable standards of purity of the drinking water of the State consistent with the public health, safety, and welfare of its citizens.

B. Definitions.

- (1) “Act” means the State Safe Drinking Water Act of 1976, and amendments.
- (2) “Action level” is the concentration of lead or copper in water specified in R.61–58.11.B(1), Lead and Copper Action Levels, which determines requirements under R.61–58.11, Control of Lead and Copper. The action for lead is 0.015 mg/L and the action level for copper is 1.3 mg/L.
- (3) “Administrator” means the Administrator of the United States Environmental Protection Agency.
- (4) “Aerator” means the device embedded in the water faucet to enhance air flow with the water stream and to prevent splashing.
- (5) “Annular space” means the space between the well casing and the formation or the space between the inner casing and outer casing where two casings are used.
- (6) “Aquifer” means a geologic formation, group of formations, or part of a formation that contains sufficient saturated permeable material to yield significant quantities of groundwater to wells and springs.
- (7) “Aquifer Storage and Recovery (ASR) Well” means a water well which allows potable water to be injected into a subsurface aquifer to be recovered by pumping at a later date.
- (8) “Artificial filter” means filter material which is placed in the annular space to increase the effective diameter of the well, and to prevent fine-grained sediments from entering the well.
- (9) “Backflow prevention device” means any device approved by the Department for use in preventing backflow under prescribed limited conditions of use.
- (10) “Bag filters” are pressure-driven separation devices that remove particulate matter larger than 1 micrometer using an engineered porous filtration media. They are typically constructed of a non-rigid, fabric filtration media housed in a pressure vessel in which the direction of flow is from the inside of the bag to outside.
- (11) “Bank filtration” is a water treatment process that uses a well to recover surface water that has naturally infiltrated into ground water through a river bed or bank(s). Infiltration is typically enhanced by the hydraulic gradient imposed by a nearby pumping water supply or other well(s).
- (12) “Bedrock” means the parent solid rock formation underlying weathered rock and soil.
- (13) “Best available technology” or “BAT” means the best technology, treatment techniques, or other means which either the Department or the Environmental Protection Agency (EPA) finds, after examination for efficacy under field conditions and not solely under laboratory conditions, are available (taking cost into consideration).
- (14) “Board” means the South Carolina Board of Health and Environmental Control charged with responsibility for implementation of the Safe Drinking Water Act.
- (15) “Boil Water Notice/Advisory” means a notice, whether written or verbal, issued by the Department, or the owner or operator of a public water system, notifying the users of the water system that the water is/may be contaminated and to boil the water (vigorous rolling boil for at least one minute) prior to using it for drinking or cooking. The notice shall give the reason for its issuance and corrective actions being taken.
- (16) “Booster Pump” means any pump installed within a water distribution system for the purpose of increasing the water pressure in the water distribution system, including distribution

storage facilities downstream from the pump. The term booster pump does not apply to the so called low service and high service pumps at water treatment plants.

(17) "Business Plan" for the purpose of these regulations means a document consisting of three sub-plans, a "Facilities Plan", a "Management Plan", and a "Financing Plan" which is intended to show how a water system will be self-sustaining and have the commitment and the financial, managerial and technical capability to consistently comply with the State Safe Drinking Water Act and these Regulations.

(18) "Cartridge filters" are pressure-driven separation devices that remove particulate matter larger than 1 micrometer using an engineered porous filtration media. They are typically constructed as rigid or semi-rigid, self-supporting filter elements housed in pressure vessels in which flow is from the outside of the cartridge to the inside.

(19) "Centralizer" means device to keep the casing and screen aligned in the center of the borehole to ensure proper emplacement of grout around the casing and artificial filter around the screens.

(20) "Certified Laboratory" means a laboratory approved by the Department under Regulation 61-81.

(21) "Certified Tester" means any person holding an up-to-date backflow prevention assembly tester certification card issued by the Department. Certified testers fall into one of the following classifications:

(a) General Tester - any person who has successfully completed an approved backflow prevention training and certification course which is sponsored by or approved by the Department, and who has personal possession of or whose employer owns a backflow prevention assembly test kit. This person provides the service of testing backflow prevention assemblies to the general public.

(b) Inspector Tester - any person with the same qualifications as the General Tester, except the Inspector Tester must be employed by a municipality, water district, subdivision, or other public water system. The Inspector Tester is normally involved in the management of a backflow prevention program, and does not sell his services to the general public.

(c) Limited Tester - any person with the same qualifications as the General Tester except the prescribed test(s) is (are) conducted only on backflow prevention assemblies which are owned by his employer. The Limited Tester does not provide testing services to the general public.

(d) Manufacturer's Agent - any person with the same qualifications as the General Tester except the prescribed test(s) is (are) conducted as an extension of his duties as a representative of a particular backflow prevention company.

(22) "Certified Well Driller" means any person currently certified by the State Environmental Certification Board to practice as a well driller in South Carolina.

(23) "Child care facility" means a location that houses a licensed provider of child care, day care, or early learning services to children, as determined by the state, local, or tribal licensing agency.

(24) "Clay" means fine-grained inorganic material (grains less than 0.0005 mm in diameter) which has very low permeability and is plastic.

(25) "Clean compliance history" is, for the purposes of R.61-58.17, a record of no MCL violations under R.61-58.5.F; no monitoring violations under R.61-58.5.G or R.61-58.17; and no coliform treatment technique trigger exceedances or treatment technique violations under R.61-58.17.

(26) "Coagulation" means a process using coagulant chemicals and mixing by which colloidal and suspended materials are destabilized and agglomerated into flocs.

(27) "Coliform Bacteria" means all aerobic and facultative anaerobic, gram-negative, non-spore forming, rod-shaped bacteria which ferment lactose with gas formation within forty eight hours at thirty-five degrees Celsius.

(28) "Combined distribution system" is the interconnected distribution system consisting of the distribution systems of wholesale systems and of the consecutive systems that receive finished water.

(29) "Commissioner" means the duly constituted Commissioner of the Department or his authorized agent.

(30) “Community Water Systems” means a public water system which serves at least fifteen service connections used by year-round residents or regularly serves at least twenty-five year-round residents. This may include, but not be limited to, subdivisions, municipalities, mobile home parks, apartments, etc.

(31) “Compliance cycle” means the nine-year calendar year cycle during which public water systems must monitor. Each compliance cycle consists of three three-year compliance periods. The first calendar year cycle begins January 1, 1993 and ends December 31, 2001; the second begins January 1, 2002 and ends December 31, 2010; the third begins January 1, 2011 and ends December 31, 2019.

(32) “Compliance period” means a three-year calendar year period within a compliance cycle. Each compliance cycle has three three-year compliance periods. Within the first compliance cycle, the first compliance period runs from January 1, 1993 to December 31, 1995; the second from January 1, 1996 to December 31, 1998; the third from January 1, 1999 to December 31, 2001.

(33) “Comprehensive Performance Evaluation” (CPE) is a thorough review and analysis of a treatment plant’s performance-based capabilities and associated administrative, operation and maintenance practices. It is conducted to identify factors that may be adversely impacting a plant’s capability to achieve compliance and emphasizes approaches that can be implemented without significant capital improvements. For purposes of compliance with R.61–58.10.H and (I) the comprehensive performance evaluation must consist of at least the following components: assessment of plant performance; evaluation of major unit processes; identification and prioritization of performance limiting factors; assessment of the applicability of comprehensive technical assistance; and preparation of a CPE report.

(34) “Cone of Depression” means the depression in the water table or potentiometric surface in an aquifer caused by pumping water from a well and usually having the shape of an inverted cone.

(35) “Confluent growth” means a continuous bacterial growth covering the entire filtration area of a membrane filter, or a portion thereof, in which bacterial colonies are not discrete.

(36) “Consecutive system” is a public water system that receives some or all of its finished water from one or more wholesale systems. Delivery may be through a direct connection or through the distribution system of one or more consecutive systems.

(37) “Contaminant” means any physical, chemical, biological, or radiological substance or matter in water.

(38) “Conventional filtration treatment” means a series of processes including coagulation, flocculation, sedimentation, and filtration resulting in substantial particulate removal.

(39) “Corrosion inhibitor” means a substance capable of reducing the corrosivity of water toward metal plumbing materials, especially lead and copper, by forming a protective film on the interior surface of those materials.

(40) “Cross-connection” means any actual or potential connection or structural arrangement between a public water supply and any other source or system through which it is possible to introduce into any part of the potable system any used water, industrial fluid, gas or substance other than the intended potable water which the system is supplied. Bypass arrangements, jumper connections, removable sections, swivel or changeover devices and other temporary or permanent devices through which or because of which backflow can or may occur are considered to be cross-connections.

(41) “CT” or “CT_{calc}” is the product of “residual disinfectant concentration” (C) in mg/L determined before or at the first customer, and the corresponding “disinfectant contact time (T) in minutes, i.e., “C” × “T”. If a public water system applies disinfectants at more than one point prior to the first customer, it shall determine the CT of each disinfectant sequence before or at the first customer to determine the total percent inactivation or “total inactivation ratio.” In determining the total inactivation ratio, the public water system shall determine the residual disinfectant concentration of each disinfection sequence and corresponding contact time before any subsequent disinfection application point(s). “CT₉₉” is the CT value required for 99.9 percent (3-log) inactivation of *Giardia lamblia* cysts. CT₉₉ for a variety of disinfectants and conditions appear in Tables 1.1–1.6, 2.1, and 3.1 of R.61–58.10.F(2)(c).

$$\frac{CT_{calc}}{CT_{99.9}}$$

is the inactivation ratio. The sum of the inactivation ratios, or total inactivation ratio shown as

$$\frac{\sum (CT_{calc})}{(CT_{99.9})}$$

is calculated by adding together the inactivation ratio for each disinfection sequence. A total inactivation ratio equal to or greater than 1.0 is assumed to provide a 3-log inactivation of *Giardia lamblia* cysts.

(42) “Dedicated Fire Line” means a water line connected to a public water system which is designed and used solely for a fire protection system. Such lines must be provided with an acceptable and approved backflow prevention device and must not connect at any point downstream of that device with water lines or fixtures that are used for potable water.

(43) “Department” means the South Carolina Department of Health and Environmental Control, including personnel thereof authorized and empowered by the Board to act on behalf of the Department or Board.

(44) “Development” means repairing damage to the aquifer caused by drilling procedures and increasing the porosity and permeability of the geologic materials surrounding the intake portion of the well.

(45) “Diatomaceous earth filtration” means a process resulting in substantial particulate removal in which (1) a precoat cake of diatomaceous earth filter media is deposited on a support membrane (septum), and (2) while the water is filtered by passing through the cake on the septum, additional filter media known as body feed is continuously added to the feed water to maintain the permeability of the filter cake.

(46) “Direct filtration” means a series of processes including coagulation and filtration but excluding sedimentation resulting in substantial particulate removal.

(47) “Disinfectant” means any oxidant, including but not limited to chlorine, chlorine dioxide, chloramines and ozone added to water in any part of the treatment or distribution process, that is intended to kill or inactivate pathogenic microorganisms.

(48) “Disinfectant contact time” (“T” in CT calculations) means the time in minutes that it takes for water to move from the point of disinfectant application or the previous point of disinfectant residual measurement to a point before or at the point where residual disinfectant concentration (“C”) is measured. Where only one “C” is measured, “T” is the time in minutes that it takes for water to move from the point of disinfectant application to a point before or where residual disinfectant concentration (“C”) is measured. Where more than one “C” is measured, “T” is (a) for the first measurement of “C”, the time in minutes that it takes for water to move from the first or only point of disinfectant application to a point before or at the point where the first “C” is measured and (b) for subsequent measurements of “C”, the time in minutes that it takes for water to move from the previous “C” measurement point to the “C” measurement point for which the particular “T” is being calculated. Disinfectant contact time in pipelines shall be calculated based on “plug flow” by dividing the internal volume of the pipe by the maximum hourly flow rate through that pipe. Disinfectant contact time within mixing basins and storage reservoirs shall be determined by tracer studies or an equivalent demonstration.

(49) “Disinfected” means that the water is free of harmful or pathogenic organisms.

(50) “Disinfection” means a process which inactivates pathogenic organisms in water by chemical oxidants or equivalent agents.

(51) “Disinfection profile” is a summary of daily *Giardia lamblia* inactivation through the treatment plant. The procedure for developing a disinfection profile is contained in R.61–58.10.H(3) (Disinfection profiling and bench marking) and in R.61–58.10.I(4) (Disinfection profile).

(52) “Dispensing Station” means a facility where additional treatment is provided to water from an approved public water system, and that treated water is available to the general public. This does not apply to point of use devices in public buildings (e.g., restaurants and cafeterias, etc.).

(53) “Distribution Treatment Plant” means any facility located within the distribution system capable of altering the physical, chemical, radiological or bacteriological quality of the water in a public water system (i.e. chlorine booster station).

(54) “Domestic or other non-distribution system plumbing problem” means a coliform contamination problem in a public water system with more than one service connection that is limited to the specific service connection from which the coliform-positive sample was taken.

(55) “Dose equivalent” means the product of the absorbed dose from ionizing radiation and such factors as account for differences in biological effectiveness due to the type of radiation and its distribution in the body as specified by the International Commission on Radiological Units and Measurements (ICRU).

(56) “Drawdown” means the difference in levels between the static water level in a well and the surface of the depressed water level that occurs when the well is pumped.

(57) “Drilling Fluid” means a water or air based fluid used in drilling to remove cuttings from the hole, to clean and cool the drill bit, to reduce friction between the drill pipe and the sides of the hole and to seal the bore hole.

(58) “Dry Line” means a water line project not connected to a source at the time application is made for the permit to construct.

(59) “Dual sample set” is a set of two samples collected at the same time and same location, with one sample analyzed for TTHM and the other sample analyzed for HAA5. Dual sample sets are collected for the purposes of conducting an IDSE under subpart U of this part and determining compliance with the TTHM and HAA5 MCLs under subpart V of this part.

(60) “Dug well” means large diameter (24 to 60-inch) well generally of low yield which is usually excavated by hand and which penetrates only a few feet below the water table.

(61) “Effective corrosion inhibitor residual” for the purpose of R.61-58.11, Control of Lead and Copper, means a concentration sufficient to form a passivating film on the interior walls of a pipe.

(62) “Effective (grain) size” means the sieve size that retains 90 percent of the materials.

(63) “Elementary school,” for the purposes of R.61-58.11 only, means a school classified as elementary by state and local practice and composed of any span of grades (including pre-school) not above grade eight (8).

(64) “Emergency” means any event which adversely impacts the ability of the system to produce or deliver safe drinking water to the consumer.

(65) “Emergency Well” means a well that is operable and connected to the distribution system, but is not routinely operated or sampled. Such wells are only available to be used during emergency situations and only in conjunction with a boil water advisory.

(66) “Enhanced coagulation” means the addition of sufficient coagulant for improved removal of disinfection byproduct precursors by conventional filtration treatment.

(67) “Enhanced softening” means the improved removal of disinfection byproduct precursors by precipitative softening.

(68) “Expansion” means installation of additions, extensions, changes, or alterations to a public water system’s existing source, transmission, storage or distribution facilities which will enable the system to increase in size its existing service area and/or number of authorized service connections.

(69) “Facilities Plan” means a document which consists of an assessment of the current and foreseeable water supply needs of a water system’s service area; a detailed description of alternatives considered for meeting those needs; detailed cost estimates for the construction, operation and maintenance of the different alternatives, and the rationale for the alternative selected. For existing systems, the description of alternatives would include but not be limited to: a detailed description of existing facilities (source, treatment and distribution); description of any upgrade necessary to bring the existing facilities into compliance with the Act and these regulations; an assessment of the ability of the existing facilities, along with any necessary upgrade, to supply the current and foreseeable water supply needs of the area (including the ability to comply with any foreseeable regulatory changes); and a description of any other alternatives considered for meeting the water supply needs.

(70) “Federal Act” means the Federal Safe Drinking Water Act, as amended.

(71) "Fifth liter sample," for purposes of R.61-58.11, Control of Lead and Copper, means a one-liter (1 L) sample of tap water collected in accordance with R.61-58.11.H(2).

(72) "Filter profile" is a graphical representation of individual filter performance, based on continuous turbidity measurements or total particle counts versus time for an entire filter run, from startup to backwash inclusively, that includes an assessment of filter performance while another filter is being backwashed.

(73) "Filtration" means a process for removing particulate matter from water by passage through porous media.

(74) "Financial Plan" means a document which consists of projections that a water system's revenues and cash flow will be sufficient for meeting the cost of construction, operation and maintenance for at least five full years from the initiation of operations. The financial plan must also include assurances deemed necessary for the system to remain viable. Such assurances may include but not be limited to: 1) a projection of rates showing a significant coverage ratio, 2) escrow funds, 3) bonding and 4) letter of credit.

(75) "Find-and-fix" means the requirements under R.61-58.11, Control of Lead and Copper, that water systems must perform at every tap sampling site that yielded a lead result above fifteen micrograms per liter (15 µg/L).

(76) "Finished water" is water that is introduced into the distribution system of a public water system and is intended for distribution and consumption without further treatment, except as treatment necessary to maintain water quality in the distribution system (e.g., booster disinfection, addition of corrosion control chemicals).

(77) "Fire Flow" means five hundred (500) gallons per minute or the flow required for fire protection by the local government or public water system, whichever is greater.

(78) "First draw sample" means the first one-liter (1 L) sample of tap water collected in accordance with R.61-58.11.H(2)(b).

(79) "Flocculation" means a process to enhance agglomeration or collection of smaller floc particles into larger, more easily settleable particles through gentle stirring by hydraulic or mechanical means.

(80) "Flowing stream" is a course of running water flowing in a definite channel.

(81) "Formation" means any substantial interval penetrated during the drilling of a well in which the geologic materials have distinct compositional characteristics with respect to adjacent overlying and underlying intervals.

(82) "Fracture Zone" means any level or interval penetrated during drilling which has void spaces caused by breakage of the formation.

(83) "Full lead service line replacement" means the replacement of a lead service line (as well as galvanized service lines requiring replacement), as defined in R.61-58.B, that results in the entire length of the service line, regardless of service line ownership, meeting the federal Safe Drinking Water Act (SDWA) Section 1417 definition of lead-free applicable at the time of the replacement. A full lead service line replacement includes a replacement where only one portion of the service line is lead, such as where a partial lead service line was previously conducted, as long as, upon completion of the replacement, the entire service line meets the SDWA Section 1417 definition of lead-free applicable at the time of the replacement. Galvanized service lines that are or were downstream of a lead service line must also be replaced for a service line to be a full lead service line replacement. A lead service line that is left in place in the ground but remains out of service may be full lead service line replacement where a new non-lead service line is installed for use instead of the out-of-service lead service line.

(84) "GAC10" means granular activated carbon filter beds with an empty-bed contact time of 10 minutes based on average daily flow and a carbon reactivation frequency of every 180 days, except that the reactivation frequency for GAC10 used as a best available technology for compliance with R.61-58.5.P(2)(b) MCLs shall be 120 days.

(85) "GAC20" means granular activated carbon filter beds with an empty-bed contact time of 20 minutes based on average daily flow and a carbon reactivation frequency of every 240 days.

(86) "Galvanized service line" means iron or steel piping that has been dipped in zinc to prevent corrosion and rusting.

(87) "Geologic Material" means naturally occurring matter derived from or consisting of rock and sediment.

(88) "Geophysical logging" means any number of techniques that measure some electrical, chemical or radioactive property of the subsurface, either characteristic of the ground water or of the rocks in which the ground water occurs.

(89) "Gooseneck, pigtail, or connector" is a short section of piping, typically not exceeding two feet (2 ft), which can be bent and used for connections between rigid service piping. For purposes of this subpart, lead goosenecks, pigtails, and connectors are not considered to be part of the lead service line, but may be required to be replaced pursuant to R.61-58.11.F(3).

(90) "Gross alpha particle activity" means the total radioactivity due to alpha particle emission as inferred from measurements on a dry sample.

(91) "Gross beta particle activity" means the total radioactivity due to beta particle emission as inferred from measurements on a dry sample.

(92) "Groundwater" means subsurface water found in void spaces in geologic materials within the zone of saturation.

(93) "Groundwater Treatment Plant" means any facility capable of altering the physical, chemical, radiological or bacteriological quality of groundwater for public consumption in a public water system.

(94) "Ground water under the direct influence of surface water (GWUDI)" means any water beneath the surface of the ground with (1) significant occurrence of insects or other microorganisms, algae, or large-diameter pathogens such as *Giardia lamblia*, or (2) *Cryptosporidium*, or (3) significant and relatively rapid shifts in water characteristics such as turbidity, temperature, conductivity, or pH which closely correlate to climatological or surface water conditions. Direct influence shall be determined for individual sources in accordance with criteria established by the Department. The Department's determination of direct influence may be based on site-specific measurements of water quality and/or documentation of well construction characteristics and geology with field evaluation.

(95) "Grout" means a fluid mixture of cement and water (neat cement) of a consistency that can be forced through a pipe and placed as required. Various additives, such as sand, bentonite, and hydrated lime, may be included in the mixture to meet certain requirements. For example, sand is added when a considerable volume of grout is needed.

(96) "Haloacetic acids (five)" (HAA5) mean the sum of the concentrations in milligrams per liter of the haloacetic acid compounds (monochloroacetic acid, dichloroacetic acid, trichloroacetic acid, monobromoacetic acid, and dibromoacetic acid), rounded to two significant figures after addition.

(97) "Halogen" means one of the chemical elements chlorine, bromine or iodine.

(98) "Hardpan" means hard impervious layer cemented by relatively insoluble secondary material.

(99) "High Rate Gravity Filter" means any gravity filter which filters water at a rate in excess of four (4) gallons per minute per square foot.

(100) "Initial compliance period" means the first full three-year compliance period which begins at least 18 months after promulgation, except for contaminants listed at R.61-58.5.B(2)(l)-(p) and those listed at R.61-58.5.D(2)(b)(xix)-(xxxiii) and R.61-58.5.N(2)(s)-(u), initial compliance period means the first full three-year compliance period after promulgation for systems with 150 or more service connections (January 1993-December 1995), and first full three-year compliance period after the effective date of the regulation (January 1996-December 1998) for systems having fewer than 150 service connections.

(101) "Lake/reservoir" refers to a natural or man made basin or hollow on the Earth's surface in which water collects or is stored that may or may not have a current or single direction of flow.

(102) "Large water system" for the purpose of R.61-58.11, Control of Lead and Copper, only, means a water system that serves more than 50,000 persons.

(103) "Lead free" means: (i) when used with respect to solders and flux, those containing not more than 0.2 percent lead; and (ii) not more than a weighted average of 0.25 percent lead when

used with respect to the wetted surfaces of pipes, pipe fittings, plumbing fittings, and fixtures as defined in 40 CFR 143.12.

(104) “Lead service line” means a portion of pipe that is made of lead, which connects the water main to the building inlet. A lead service line may be owned by the water system, owned by the property owner, or both. For the purposes of this subpart, a galvanized service line is considered a lead service line if it ever was or is currently downstream of any lead service line or service line of unknown material. If the only lead piping serving the home is a lead gooseneck, pigtail, or connector, and it is not a galvanized service line that is considered a lead service line the service line is not a lead service line. For purposes of R.61–58.11.H(1) only, a galvanized service line is not considered a lead service line.

(105) “Lead status unknown service line” means a service line that has not been demonstrated to meet or not meet the federal SDWA Section 1417 definition of lead free. It is not necessary to physically verify the material composition (for example, copper or plastic) of a service line for its lead status to be identified (e.g., records demonstrating the service line was installed after a municipal, state, or federal lead ban).

(106) “Lead trigger level” means a particular concentration of lead in water that prompts certain activities under R. 61–58.11, Control of Lead and Copper. The trigger level for lead is a concentration of ten micrograms per liter (10µg/L).

(107) “Legionella” means a genus of bacteria, some species of which have caused a type of pneumonia called Legionnaires Disease.

(108) “Level 1 assessment” is an evaluation to identify the possible presence of sanitary defects, defects in distribution system coliform monitoring practices, and (when possible) the likely reason that the system triggered the assessment. It is conducted by the system operator or owner. Minimum elements include review and identification of atypical events that could affect distributed water quality or indicate that distributed water quality was impaired; changes in distribution system maintenance and operation that could affect distributed water quality (including water storage); source and treatment considerations that bear on distributed water quality, where appropriate (e.g., whether a ground water system is disinfected); existing water quality monitoring data; and inadequacies in sample sites, sampling protocol, and sample processing. The system must conduct the assessment consistent with any Department directives that tailor specific assessment elements with respect to the size and type of the system and the size, type, and characteristics of the distribution system.

(109) “Level 2 assessment” is an evaluation to identify the possible presence of sanitary defects, defects in distribution system coliform monitoring practices, and (when possible) the likely reason that the system triggered the assessment. A Level 2 assessment provides a more detailed examination of the system (including the system’s monitoring and operational practices) than does a Level 1 assessment through the use of more comprehensive investigation and review of available information, additional internal and external resources, and other relevant practices. It is conducted by an individual approved by the Department, which may include the system operator. Minimum elements include review and identification of atypical events that could affect distributed water quality or indicate that distributed water quality was impaired; changes in distribution system maintenance and operation that could affect distributed water quality (including water storage); source and treatment considerations that bear on distributed water quality, where appropriate (e.g., whether a ground water system is disinfected); existing water quality monitoring data; and inadequacies in sample sites, sampling protocol, and sample processing. The system must conduct the assessment consistent with any Department directives that tailor specific assessment elements with respect to the size and type of the system and the size, type, and characteristics of the distribution system. The system must comply with any expedited actions or additional actions required by the Department in the case of an E. coli MCL violation.

(110) “Limestone” means a sedimentary formation composed chiefly of calcium carbonate, consolidated or unconsolidated, which may be in the form of shell pieces or calcareous muds or sands.

(111) “Locational running annual average (LRAA)” is the average of sample analytical results for samples taken at a particular monitoring location during the previous four calendar quarters.

(112) “Man-made beta particle and photon emitters” means all radionuclides emitting beta particles and/or photons listed in Maximum Permissible Body Burdens and Maximum Permissible Concentration of Radionuclides in Air or Water for Occupational Exposure, NBS Handbook 69, except the daughter products of thorium-232, uranium-235, and uranium-238.

(113) “Management Plan” means a document which consists of the identification of a water system’s owner; description of the management structure; an organizational chart; staffing requirements and duties; identification of any outside services and a copy of any service agreements; a copy of the system’s operation and maintenance procedures required by R.61–58.7.B; and a detailed estimate of costs for the operation and maintenance of the system as it relates to the management plan, unless included in the cost estimate for the facilities plan.

(114) “Marl” means calcareous clay. In South Carolina, the term is mostly applied to the Cooper Marl or Eocene Age, characterized by its dark greenish drab to grayish green color.

(115) “Maximum contaminant level” means the maximum permissible level of a contaminant in water which is delivered to any user of a public water system.

(116) “Maximum residual disinfectant level” (MRDL) means a level of a disinfectant added for water treatment that may not be exceeded at the consumer’s tap without an unacceptable possibility of adverse health effects. For chlorine and chloramines, a PWS is in compliance with the MRDL when the running annual average of monthly averages of samples taken in the distribution system, computed quarterly, is less than or equal to the MRDL. For chlorine dioxide, a PWS is in compliance with the MRDL when daily samples are taken at the entrance to the distribution system and no two consecutive daily samples exceed the MRDL. MRDLs are enforceable in the same manner as maximum contaminant levels under Section 1412 of the Safe Drinking Water Act. There is convincing evidence that addition of a disinfectant is necessary for control of waterborne microbial contaminants. Notwithstanding the MRDLs listed in R.61–58.5.Q, operators may increase residual disinfectant levels of chlorine or chloramines (but not chlorine dioxide) in the distribution system to a level and for a time necessary to protect public health to address specific microbiological contamination problems caused by circumstances such as distribution line breaks, storm runoff events, source water contamination, or cross-connections.

(117) “Maximum residual disinfectant level goal” (MRDLG) means the maximum level of a disinfectant added for water treatment at which no known or anticipated adverse effect on the health of persons would occur, and which allows an adequate margin of safety. MRDLGs are nonenforceable health goals and do not reflect the benefit of the addition of the chemical for control of waterborne microbial contaminants.

(118) “Maximum Total Trihalomethane Potential” means the maximum concentration of total trihalomethanes produced in a given water containing a disinfectant residual after seven days at a temperature of 25°C or above.

(119) “Mechanical logging” means any number of techniques that measure some physical property of the subsurface.

(120) “Medium-size water system” for the purpose of R.61–58.11, Control of Lead and Copper, only, means a water system that serves greater than 10,000 persons and less than or equal to 50,000 persons.

(121) “Membrane filtration” is a pressure or vacuum driven separation process in which particulate matter larger than 1 micrometer is rejected by an engineered barrier, primarily through a size-exclusion mechanism, and which has a measurable removal efficiency of a target organism that can be verified through the application of a direct integrity test. This definition includes the common membrane technologies of microfiltration, ultrafiltration, nanofiltration, and reverse osmosis.

(122) “Method detection limit (MDL)” means the minimum concentration of a substance that can be measured and reported with ninety-nine percent (99%) confidence that the analyte concentration is greater than zero (0) and is determined from analysis of a sample in a given matrix containing the analyte.

(123) “National Primary Drinking Water Regulations” means primary drinking water regulations promulgated by the Administrator pursuant to the Federal Act and contained in 40 CFR Part 141, as amended.

(124) “Natural filter” means the material adjacent to the screens in Type II wells which is part of the screened formation and which is relatively free of fine-grained material as a result of well development.

(125) “National Secondary Drinking Water Regulations” means secondary drinking water regulations promulgated by the Administrator pursuant to the Federal Act, and contained in 40 CFR Part 143, as amended.

(126) “Near the first service connection” means at one of the 20 percent of all service connections in the entire system that are nearest the water supply treatment facility, as measured by water transport time within the distribution system.

(127) “Non-caving formation” means formation which will not collapse into an open borehole drilled through it such as igneous and metamorphic crystalline rocks, limestone, tight clay, etc.

(128) “Non-coliform growth (NCG)” means any bacterial growth other than coliform type which appears in a membrane filter test for coliform bacteria.

(129) “Non-community water system” means a public water system which serves at least fifteen (15) service connections or regularly serves an average of at least twenty-five (25) individuals daily at least sixty (60) days out of the year, and does not meet the definition of a community water system.

(130) “Non-transient non-community water system” means a public water system that is not a community water system and that regularly serves at least twenty-five (25) of the same persons over six months per year.

(131) “Operator” means a person certified by the South Carolina Environmental Certification Board as being qualified to operate and maintain a public water system. Operation and maintenance responsibilities shall include, but not be limited to, conducting tests of the raw and treated water, adjusting chemical feed rates, and/or operating equipment so as to change the physical, chemical, radiological or bacteriological quality of surface or ground water to meet established standards.

(132) “Optimal corrosion control treatment” for the purpose of R.61–58.11, Control of Lead and Copper, only, means the corrosion control treatment that minimizes the lead and copper concentrations at users’ taps while insuring that the treatment does not cause the water system to violate any national primary drinking water regulations.

(133) “Partial lead service line replacement” means replacement of any portion of a lead service line or galvanized service line requiring replacement, as defined in this section, that leaves in service any length of lead service line or galvanized service line requiring replacement upon completion of the work. Partial lead service line replacements are permitted under limited circumstances under R.61–58.11.F(4) but do not count towards the mandatory or goal-based lead service line replacement rate.

(134) “Penetration rate log” means tabulation of the time required to drill unit depth intervals such as minutes per foot, minutes per 5-feet, minutes per drill rod section, etc.

(135) “Performance evaluation sample” means a reference sample provided to a laboratory for the purpose of demonstrating that the laboratory can successfully analyze the sample within limits of performance specified by the Department. The true value of the concentration of the reference material is unknown to the laboratory at the time of the analysis.

(136) “Person” means an individual, partnership, co-partnership, cooperative, firm, company, public or private corporation, political subdivision, agency of the State, trust, estate, joint structure company or any other legal entity or their legal representative, agent or assigns.

(137) “Picocurie (pCi)” means that quantity of radioactive material producing 2.22 nuclear transformations per minute.

(138) Pitcher filter means a non-plumbed water filtration device which consists of a gravity-fed water filtration cartridge and a filtered drinking water reservoir that is certified by an American National Standards Institute accredited certifier to reduce lead in drinking water.

(139) “Plant intake” refers to the works or structures at the head of a conduit through which water is diverted from a source (e.g., river or lake) into the treatment plant.

(140) “Point of disinfectant application” is the point where the disinfectant is applied and water downstream of that point is not subject to recontamination by surface water runoff.

(141) “Point-of-entry treatment device (POE)” is a treatment device applied to the drinking water entering a house or building for the purpose of reducing contaminants in the drinking water distributed throughout the house or building.

(142) “Point-of-use treatment device or point of use device (POU)” is a water treatment device physically installed or connected to a single fixture, outlet, or tap to reduce or remove contaminants in drinking water. For the purposes of R.61–58.11, Control of Lead and Copper, it must be certified by an American National Standards Institute accredited certifier to reduce lead in drinking water.

(143) “Pollution Source” means a facility or activity which may introduce any dangerous material to the groundwater system below the water table in concentrations sufficient to cause drinking water quality standards to be exceeded or to decrease the quality of the drinking water. Pollution sources shall include, but not be limited to, the following:

- a. Septic tank
- b. Tile Field
- c. Sewer line
- d. Abandoned unprotected well
- e. Waste treatment lagoon
- f. Storage lagoon
- g. Animal feedlot
- h. Chemical handling area
- i. Chemical storage area
- j. Petroleum storage area
- k. Waste disposal area
- l. Mine

(144) “Practical quantitation limit (PQL)” means the minimum concentration of an analyte (substance) that can be measured with a high degree of confidence that the analyte is present at or above that concentration.

(145) “Presedimentation” is a preliminary treatment process used to remove gravel, sand and other particulate material from the source water through settling before the water enters the primary clarification and filtration processes in a treatment plant. May be with or without chemical addition.

(146) Pre-stagnation flushing is the opening of tap(s) to flush standing water from plumbing prior to the minimum six (6)-hour stagnation period in anticipation of lead and copper tap sampling under R.61–58.11, Control of Lead and Copper.

(147) “Primary Drinking Water Regulation” means the maximum contaminant limits, the requirements for monitoring, the requirements for reporting, record retention requirements and public notification specified in R.61–58.5, Maximum Contaminants in Drinking Water, and R.61–58.6, Reports, Record Retention and Public Notification of Drinking Water Violations.

(148) “Professional Engineer” means a person properly qualified to perform engineering work as provided in Title 40 of the 1976 Code of Laws of South Carolina, as amended, Chapter 22, Engineers and Land Surveyors.

(149) “Professional Geologist” means a person registered as a professional geologist by the South Carolina State Board of Registration for Geologists.

(150) “Public Water System” means (1) any public or privately owned waterworks system which provides drinking water, whether bottled or piped, for human consumption, including the source of supply whether the source of supply is of surface or subsurface origin; (2) all structures and appurtenances used for the collection, treatment, storage or distribution of drinking water delivered to consumers; (3) any part or portion of the system and including any water treatment facility which in any way alters the physical, chemical, radiological, or bacteriological characteristics of drinking water; provided, that public water system shall not include a drinking water system serving a single private residence or dwelling. A separately owned system with its source of supply from another waterworks system shall be a separate public water system.

(151) “Rapid Mix” means the rapid dispersion of chemicals throughout the water to be treated, usually by violent agitation.

(152) “Rapid Rate Gravity Filter” means a gravity filter not to exceed 4 gallons per minute per square foot of surface area.

(153) “Raw water” means untreated water as obtained from the source.

(154) “Rem” means the unit of dose equivalent from ionizing radiation to the total body or any internal organ or organ system. A “millirem (mrem)” is one one-thousandth of a rem.

(155) “Repeat compliance period” means any subsequent compliance period after the initial compliance period.

(156) “Residual disinfectant concentration” (“C” in CT calculations) means the concentration of disinfectant measured in mg/L in a representative sample of water.

(157) “Sand” means a detrital geologic material in the form of un-cemented particles having a size range from two (2) millimeters to one-sixteenth (1/16) of a millimeter and composed of mineral crystals or rock fragments.

(158) “Sanitary defect” is a defect that could provide a pathway of entry for microbial contamination into the distribution system or that is indicative of a failure or imminent failure in a barrier that is already in place.

(159) “Sanitary Seal” means a cap on the top of the well casing usually fitted with a rubber expansion gasket, which seals off surface drainage, thereby protecting the well from contamination directly down the casing.

(160) “School,” for the purpose of R.61–58.11 only, means any building(s) associated with public, private, or charter institutions that primarily provides teaching and learning for elementary or secondary students.

(161) “Seasonal system” is a non-community water system that is not operated as a public water system on a year-round basis and starts up and shuts down at the beginning and end of each operating season.

(162) “Secondary Containment” means a basin constructed to receive the liquids spilled from any chemical storage tank or solution tank, and shall be designed to prevent migration of any accumulated liquid out of the basin to the soil, ground-water, or surface water at any time. The volume of the secondary containment shall equal or exceed the volume of the tank. Where more than one (1) tank is located in the secondary containment area, the volume of the secondary containment shall be equal to or greater than the volume of the largest tank.

(163) “Secondary maximum contaminant level” means the maximum contaminant levels which, in the judgment of the Department, are requisite to protect the public welfare. Such levels may apply to any contaminant in drinking water (1) which may adversely affect the odor or appearance of such water and consequently may cause a substantial number of the persons served by the public water system providing such water to discontinue its use, or (2) which may otherwise adversely affect the public welfare. Such levels may vary according to geographic and other circumstances.

(164) “Secondary school,” for the purpose of R.61–58.11 only, means a school comprising any span of grades beginning with the next grade following an elementary or middle school (usually grades seven through nine (7–9) and ending with or below grade twelve (12). Both junior high schools and senior high schools are included.

(165) “Sedimentation” means a process for removal of solids before filtration by gravity or separation.

(166) “Service line sample” means a one-liter sample of water, collected in accordance with R.61–58.11.H(2)(c), Sample Collection Methods, that has been standing for at least 6 hours in a service line.

(167) “7Q10” means the minimum average annual stream flow that can statistically be expected to occur for a seven day period once every ten years.

(168) “Sieve analysis” means a method of determining grain-size distribution by mechanically separating the various size portions using a set of graduated sieves and weighing the portion of the

sample retained on each sieve. These weights are converted to percent retained and graphically plotted against grain size to show the grain size distribution in a well.

(169) “Single family structure” for the purpose of R.61–58.11, Control of Lead and Copper, only, means a building constructed as a single-family residence that is currently used as either a residence or a place of business.

(170) “Slow sand filtration” means a process involving passage of raw water through a bed of sand at low velocity (generally less than 0.4 m/h) resulting in substantial particulate removal by physical and biological mechanisms.

(171) “Small water system” for the purpose of R.61–58.11, Control of Lead and Copper, only, means a water system that serves 3,300 persons or fewer.

(172) “Specific Capacity” means the rate of well yield per unit of drawdown. It is usually expressed as gallons-per-minute per foot of drawdown and is a required measurement in selecting pump setting and size.

(173) “Stabilized Water” means water which has been physically or chemically altered to reduce its aggressiveness or corrosiveness.

(174) “Stand-by Well” means a well that is not routinely used, but which can be immediately placed into operation if needed. Such wells are routinely exercised and sampled by the water system to ensure operability and water quality.

(175) “Standard sample” means the aliquot of finished drinking water that is examined for the presence of coliform bacteria.

(176) “State Water System” or SWS means any water system that serves less than fifteen (15) service connections or regularly serves an average of less than twenty-five (25) individuals daily.

(177) “Static water level” means the stable water level which has not been affected by pumping the well in which it is measured.

(178) “Subpart H systems” means public water systems using surface water or ground water under the direct influence of surface water as a source that are subject to the requirements of 40 CFR 141, subpart H.

(179) “Supplier of water” means any person who owns or operates a public water system.

(180) “Surface water” means all water which is open to the atmosphere and subject to surface runoff.

(181) “Surface Water Treatment Plant” means any facility capable of altering the physical, chemical, radiological or bacteriological quality of surface water to produce water for public consumption in a public water system.

(182) “SUVA” means Specific Ultraviolet Absorption at 254 nanometers (nm), an indicator of the humic content of a water. It is a calculated parameter obtained by dividing a sample’s ultraviolet absorption at a wavelength of 254 nm (UV_{254}) (in m^{-1}) by its concentration of dissolved organic carbon (DOC) (in mg/L).

(183) “System with a single service connection” means a system which supplies drinking water to consumers via a single service line.

(184) “System without corrosion control treatment” means a public water system that does not have or purchases all of its water from a system that does not have: (1) An optimal corrosion control treatment approved by the Department; or (2) Any pH adjustment, alkalinity adjustment, and/or corrosion inhibitor addition resulting from other water quality adjustments as part of its treatment train infrastructure.

(185) “Tap” means a service connection, the point at which water is delivered to the consumer (building, dwelling, commercial establishment, camping space, industry, etc.) from a distribution system, whether metered or not and regardless of whether there is a user charge for consumption of the water.

(186) “Tap sampling monitoring period,” for the purposes of R.61–58.11, Control of Lead and Copper, means the period of time during which each water system must conduct tap sampling for lead and copper analysis. A tap sampling monitoring period is determined by lead and copper concentrations in tap samples and the frequency can range from every six (6) months (i.e., semi-

annual) up to once every nine (9) years. Water systems on semi-annual tap sampling monitoring must collect samples no less frequently than every six (6) months while those on annual monitoring must sample no less frequently than every year. Water systems on triennial monitoring must collect samples no less frequently than every three (3) years; and those on monitoring waivers must sample no less frequently than every nine (9) years. The start of each new tap sampling monitoring period, with the exception of semi-annual monitoring, must begin on January 1.

(187) “Tap sampling period,” for the purpose of R.61–58.11 only, means the time period, within a tap sampling monitoring period, during which the water system is required to collect samples for lead and copper analysis. For systems monitoring at a reduced frequency, the tap sampling period must be between the months of June and September, unless a different four (4)-month period of time is approved in writing to be more appropriate by the Department.

(188) “Tap sampling protocol” means the instructions given to residents or those sampling on behalf of the water system to conduct tap sampling under R.61–58.11, Control of Lead and Copper.

(189) “Too numerous to count” means that the total number of bacterial colonies exceeds 200 on a 47-mm diameter membrane filter used for coliform detection.

(190) “Total Organic Carbon” (TOC) means total organic carbon in mg/L measured using heat, oxygen, ultraviolet irradiation, chemical oxidants, or combinations of these oxidants that convert organic carbon to carbon dioxide, rounded to two significant figures.

(191) “Total Trihalomethanes” means the sum of the concentration in milligrams per liter of the trihalomethane compounds [trichloromethane (chloroform), dibromochloromethane, bromodichloromethane, tribromomethane (bromoform)], rounded to two significant figures.

(192) “Transient non-community water system” or TWS means a non-community water system that does not regularly serve at least 25 of the same persons over six months per year.

(193) “Tremie pipe” means a device, usually a small diameter pipe, that carries grouting materials to the bottom of the zone to be grouted and which allows pressure grouting from the bottom up without introduction of appreciable air pockets.

(194) “Trihalomethane” means one of the family of organic compounds, named as derivatives of methane, wherein three of the four hydrogen atoms in methane are each substituted by a halogen atom in the molecular structure.

(195) “Two-stage lime softening” is a process in which chemical addition and hardness precipitation occur in each of two distinct unit clarification processes in series prior to filtration.

(196) “Uncovered finished water storage facility” is a tank, reservoir, or other facility used to store water that will undergo no further treatment to reduce microbial pathogens except residual disinfection and is directly open to the atmosphere.

(197) “Uniformity coefficient” means the ratio of the sieve size that will retain 40 percent of the aquifer materials to the effective size.

(198) “Viable Water System” means a water system which is self-sustaining and has the commitment and the financial, managerial and technical capability to consistently comply with the State Safe Drinking Water Act (44–55–10 et seq.) and these regulations.

(199) “Virus” means a virus of fecal origin which is infectious to humans by waterborne transmission.

(200) “Vending Machine” means any self-service device which upon insertion of a coin, coins, or token, or upon receipt of payment by other means, dispenses unit servings of water in bulk, without the necessity of refilling the machine between each operation.

(201) “Waterborne disease outbreak” means the significant occurrence of acute infectious illness, epidemiologically associated with the ingestion of water from a public water system which is deficient in treatment, as determined by the Department.

(202) “Well” means a bored, drilled or driven shaft, or a dug hole whose depth is greater than the largest surface dimension, from which water is extracted or injected. This shall include, but not be limited to, wells used for water supply for irrigation, industrial or manufacturing processes or drinking water; wells used for underground injection of waste for disposal, storage, or drainage

disposal; wells used in mineral or geothermal recovery, and any other special process well. In South Carolina, wells used for public water supplies fall into one of the following types of construction:

- a. Type I - open hole wells into bedrock aquifers.
- b. Type II - screened, natural filter wells into unconsolidated aquifers.
- c. Type III - screened, artificial filter (gravel pack) wells into unconsolidated aquifers.
- d. Type IV - open hole wells into limestone aquifers.

(203) "Well Casing" means tubular retaining structure, generally metal, which is installed in the excavated hole to maintain the well opening.

(204) "Well interference" means the additive drawdown effects to two or more wells pumping from the same aquifer in the same vicinity.

(205) "Wholesale system" is a public water system that treats source water as necessary to produce finished water and then delivers some or all of that finished water to another public water system. Delivery may be through a direct connection or through the distribution system of one or more consecutive systems.

(206) "Wide-mouth bottles," for the purpose of R.61-58.11 only, means bottles configured with a mouth that is at least fifty-five millimeters (55 mm) wide that are one liter (1 L) in size.

C. Appeals.

Any determination made by the Department pursuant to these regulations shall be subject to the provisions of R.61-72 and the Administrative Procedures Act.

D. Severability.

Should any section, paragraph or other part of these regulations be declared invalid for any reason, the remainder shall not be affected.

E. Violations and Penalties.

Any person or persons violating these regulations shall be subject to the penalties provided in Section 44-55-90, of the 1976 Code of Laws, as amended.

HISTORY: Amended by State Register Volume 12, Issue No. 11, eff November 25, 1988; State Register Volume 17, Issue No. 8, eff August 27, 1993; State Register Volume 17, Issue No. 12, eff December 24, 1993; State Register Volume 18, Issue No. 11, eff November 25, 1994; State Register Volume 19, Issue No. 7, eff July 28, 1995; State Register Volume 22, Issue No. 6, Part 2, eff June 26, 1998; State Register Volume 24, Issue No. 2, eff February 25, 2000; State Register Volume 26, Issue No. 5, Part 1, eff May 24, 2002; State Register Volume 26, Issue No. 12, eff December 27, 2002; State Register Volume 30, Issue No. 10, eff October 27, 2006; State Register Volume 38, Issue No. 9, Doc. No. 4469, eff September 26, 2014; SCSR 46-12 Doc. No. 5135, eff December 23, 2022.

61-58.1. Construction and Operation Permits.

Table of Contents

- A. Applicability
- B. Requirements for Construction Permits
- C. Engineer's Report
- D. Application for Public Water System Construction Permit
- E. Construction Plans
- F. Specifications
- G. Design Data
- H. Requirements for a General Construction Permit
- I. Delegated Review Program
- J. Revisions to Approved Plans
- K. Requirements for Obtaining Approval to Place Permitted Construction into Operation
- L. Drinking Water Dispensing Stations and Vending Machines
- M. Bottled Water

N. Request for Review of Permit Decisions

A. Applicability.

This Regulation establishes procedures for obtaining construction and operational permits from the Department.

B. Requirements for Construction Permits.

(1) Before the construction, expansion or modification of any public water system, application for a permit to construct shall be made to, and a permit to construct obtained from, the Department.

(2) The application for a permit to construct shall include the following documentation:

(a) a completed application form for a permit to construct submitted in triplicate (one original and two copies);

(b) four (4) sets of detailed plans (including location map);

(c) three (3) sets of material and construction specifications, except when Department-approved standard specifications are to be used for the construction project;

(d) design data and calculations;

(e) if the owner of the project is different from the utility supplying the water, a letter from the utility supplying the water stating their willingness and ability to serve the project;

(f) if the owner of the project is different from the person that will be responsible for operating and maintaining the project, a letter from that person acknowledging such responsibility; and,

(g) if the owner of the project is different from the entity which has legal authority to serve or grant franchises for the area in which the project is located, the application shall include a letter from that legal entity stating that the proposed project is consistent with the water supply service plan for the area. This letter is not required if the project will not supply water to any person within the service or franchise area, other than to the legal authority.

(3) The application procedure outlined in R.61-58.1(B)(2) is based on a design-bid-build concept for the construction of a project. The Department may consider on a case by case basis alternate design and construction concepts and issue construction permits accordingly.

(4) Before a permit to construct can be issued for a new public water system, the applicant shall demonstrate to the satisfaction of the Department that the new system will be a "viable water system" as defined in R.61-58(B). In addition to the documentation required in R.61-58.1(B)(2), the application for a permit to construct a new public water system shall include a management plan and a multi-year financial plan. These plans will not be required for those new systems whose only source of water is from an existing viable water system and the new system does not provide additional treatment to the water or sell the water. If the application proposes that the new system has its own source of water (i.e., its own well(s) or surface water treatment plant), the applicant shall evaluate the feasibility of connecting to an existing viable public water system as part of the demonstration of viability. This evaluation shall include, but not be limited to, a determination of the willingness and ability of an existing system to serve the project, water quality, capital cost of constructing the line extension versus constructing a new source and the operation and maintenance costs of both alternatives. Any cost comparisons between creating a new water system with its own source of water and connecting to an existing viable water system shall not be based on any subsidized monitoring. Also any financing of the new system shall not utilize a loan amortization schedule which exceeds the useful life of the facility or its components. This demonstration of viability may be presented to the Department in the form of a Preliminary Engineering Report or as an engineering report submitted when applying for a permit to construct.

(5) For projects in the eight coastal counties, no permit may be issued until the project is found by the Department to be consistent with the Coastal Zone Management Program.

(6) Projects involving construction in state navigable waters will be evaluated by the Department for compliance with the Department's regulations concerning such construction before a permit may be issued.

(7) For projects involving a surface water discharge of water treatment residuals or wastewater, a National Pollutant Discharge Elimination System (NPDES) permit must be obtained from the Department. For projects involving land application of water treatment residuals or wastewater, a No Discharge (ND) permit must be obtained from the Department. No construction permit can be issued for such projects until a valid NPDES or ND permit is obtained.

(8) For projects involving a new groundwater source(s), the permitting will be a two step process. In the first step the owner must submit an application for a permit to construct the source. This construction will involve the drilling of the well, the development of the well, conducting a pumping test in accordance with R.61-58.2(B)(12) and testing the water quality in accordance with R.61-58.2(B)(14). The second step will involve the permitting of the pumping equipment, concrete pad, well head piping, and any treatment, storage and/or distribution facilities associated with the source. The owner must make a second application for a permit to construct these facilities. This second application must include the well record form, the necessary plans and specifications and calculations for these facilities along with the results of the pumping test and water quality analyses. The Department may waive this two-step permitting process and issue a single construction permit for the entire project if the quality and quantity of water from the proposed well can be reasonably predicted through information available from existing wells in the immediate area or a test well. In the event the quantity and/or quality of water from the well is different than anticipated in the original design, revised plans and specifications must be submitted to the Department for approval prior to proceeding with the construction of the project.

(9) Construction permits are valid for three (3) years, from the date of issue, at which time the project must be completed or an extension must be applied for in writing. The extension request must be made by the professional engineer of record for the project and, if applicable, shall include current flow test data. Projects for which the permit to construct has been expired for more than one (1) year are considered new projects and must include a new application as required in paragraph 2 of this section.

(10) A permit to construct may be denied when:

(a) the project does not comply with the design requirements specified in R.61-58.2, R.61-58.3, and R.61-58.4;

(b) the water quality fails to comply with the drinking water standards specified in R.61-58.5;

(c) the owner of a proposed new system fails to prove to the Department's satisfaction that the system will be a "viable water system" as defined in R.61-58(B); or,

(d) the project does not comply with the Department's regulations for permits for construction in navigable waters.

(e) the project does not comply with the Interbasin Transfer Act and R.121-12.1 et seq., Code of Laws of South Carolina, 1976, as amended.

(11) Piping associated with a service connection will not require a construction permit if the following conditions are met:

(a) all piping associated with the connection is dedicated strictly for use by a single customer being served water;

(b) the customer consists of only a single house, single mobile home, single building or multiple-building complex under single ownership with no rental units (e.g., schools or industry);

(c) the customer is not a shopping mall, multiple-building complex where there will be several owners or renters (e.g., apartment complex, condominium complex, mobile home park, campground, industrial park, or business park) or marina; and,

(d) the line serving the customer does not pass a lot or potential customer between the connection and the customer to be served (this includes the piping downstream or the service meter as well as piping upstream of the service meter).

(12) Failure to obtain a permit to construct is a violation of the Act (Code Section 44-55-40) and is subject to an enforcement action by the Department. Where a person has failed to obtain a permit to construct, an application for permit must be submitted and must include record drawings carrying the seal and signature of a professional engineer.

(13) A 15-day local government notification period shall lapse prior to the issuance of any construction permit. This notification period shall be waived for any projects permitted under the provisions of a general construction permit and delegated review program. This notification period may be waived by the cognizant local government or by the Department if the construction is necessary in order to maintain a safe and adequate supply of water during an emergency. A letter from the local government having potable water planning authority for the area approving the project constitutes a waiver by the cognizant local government.

(14) A dedicated fire line protected by an approved backflow prevention device located at the point of connection to the public water system's distribution line will not require a permit to construct.

C. Engineer's Report.

A preliminary engineering report shall be prepared in triplicate for each new surface water intake, surface water treatment plant, expansion or modification to an existing surface water intake or surface water treatment plant, or other projects deemed necessary by the Department. This report shall carry the seal and signature of a professional engineer. The engineer's report shall, where pertinent, present the following information:

(1) General Information (Required for Each Report):

(a) name, address, phone number of owner, corporation, town or utility as well as name of responsible officer;

(b) name, address, phone number of engineering firm and name of engineer responsible for design;

(c) general description of service area and surroundings (type of economy, estimated percent residential, estimated percent industrial, terrain, location, possible rate of development);

(d) number and type of customers to be served, (i.e., domestic, industrial, commercial, agricultural, etc.); and,

(e) approval of any land use and development by area planning council which has jurisdiction.

(2) Surface Water Sources

(a) location map including latitude and longitude of intake;

(b) name of source(s), type (river, lake, etc.) and classification (Water Classifications and Standards, R.61-68);

(c) watershed area;

(d) expected 7Q10 flow and lowest flow of record of source(s);

(e) name and type of discharges within ten (10) miles upstream (industrial, agricultural, municipal and other);

(f) chemical and bacteriological analyses of raw water. This analysis must include all parameters addressed in R.61-58.5;

(g) distance from raw water supply to reservoir or plant;

(h) proposed pumping rate from source;

(i) general description of intake and pump house; and,

(j) a detailed engineering and economic assessment on the feasibility of utilizing alternative water sources, or combinations of water sources, other than the proposed water source.

(3) Water Treatment Plants

(a) Projected maximum volume of water to be treated;

(b) Year when plant is expected to operate at its maximum capacity;

(c) If existing, present operating capacity;

(d) Location map of plant;

(e) Height above the one hundred (100) year flood plain based on the best information available;

- (f) Land available for future plant expansion;
- (g) Proposed treatment scheme shown in block diagram;
- (h) Proposed design criteria (retention times, velocities, weir overflow rates, filtration rates, etc.);
- (i) Description of proposed method of handling, treating, and disposing of wastewater from plant (includes clarification sludge, filter backwash water, brines, etc.);
- (j) Name(s) and grade(s) of operator(s);
- (k) For modifications to existing treatment plant, report must include: Present capacity of raw water pumps, and a brief description of what effect proposed modification will have on existing facilities including velocities and retention times through plant; and,
- (l) Detailed description of any pilot testing to be performed.

D. Application for Public Water System Construction Permit.

Three (3) copies (the original and two (2) copies) of the application form completed and signed by the professional engineer and the owner shall accompany all submittals for formal approval. Copies of this application form may be obtained from the Department and shall include:

- (1) Name and location of project;
- (2) Brief description of project including, if applicable, type of source, diameter of well, treatment, expected yield and storage, number and type of services length and size(s) of distribution lines and number of fire hydrants;
- (3) Owner's name and address (person on whose behalf application is made);
- (4) Name and address of utility or organization responsible for operating and maintaining the system;
- (5) Name of the water system providing water;
- (6) Department system number of the water system providing water, and;
- (7) Signatures of the professional engineer(s) responsible for the design and construction inspections and the owner of the project.

E. Construction Plans.

Construction plans shall carry the seal and signature of a professional engineer and, where applicable, shall provide the following:

- (1) General layout drawn to scale on plan sheets no larger than thirty (30) inches by forty-two (42) inches, including:
 - (a) suitable title;
 - (b) name of utility or owner;
 - (c) area or institution to be served;
 - (d) scale, in feet;
 - (e) north reference point;
 - (f) any physical or political boundaries within the area to be served including utility easements;
 - (g) sufficient number of elevations (Mean Sea Level) to characterize terrain in the area;
 - (h) date (including month, day, and year), address, and name of the professional engineer responsible for the design.
 - (i) legible prints;
 - (j) location and size of existing water mains;
 - (k) location and nature of existing water works structures and appurtenances affecting the proposed improvements, noted on one sheet;
 - (l) for small water systems supplied by wells, the location of all existing wells within the system; and,
 - (m) site location map.

(2) Detailed plans, including:

(a) Construction drawings of distribution system addition drawn to a scale of no smaller than one inch equals two hundred (200) feet showing location of all appurtenances referenced to fixed above ground objects including size, length, identity, and location of sewers, drains, water mains, plant structures, petroleum storage facilities, and for new well projects any other pollution source as defined under "Pollution Sources" in R.61-58.(B). The Department may grant a variance to the 200 feet/inch scale on a case by case basis if the drawings adequately show all necessary physical features mentioned in this item;

(b) Where requested by the Department, profiles including hydraulic gradients for lines ten (10) inches and larger having a horizontal scale of not more than one hundred (100) feet to the inch and a vertical scale of not more than ten (10) feet to the inch, with both scales clearly indicated;

(c) Stream crossings, providing profiles with elevations (MSL) of the stream bed and the normal and extreme high and low water levels;

(d) Schematic drawing of proposed well construction, showing diameter and depth of drill hole(s), casing diameters and depths, grouting depths, elevations and designations of geological formations, water levels and other details to describe the proposed well completely;

(e) Drawing(s) of wellhead construction showing the concrete pad, sanitary seal, screened vent, check valve, pressure gauge, flow meter, blowoff, sample tap, gate valve(s), air line and gauge for measuring water level in the well, protective cover for wellhead, well identification plate;

(f) Topography and arrangement of present or planned wells or structures, with contour interval not greater than two (2) feet for a minimum one hundred (100) foot radius;

(g) Elevation drawings of structures showing the one hundred (100) year flood plain (MSL) and elevations of floor, bottom, overflows, etc. within the structure;

(h) Location and size of property to be used for groundwater development with respect to known references;

(i) Location of all real or potential sources of pollution within two hundred fifty (250) feet of a groundwater source or wellhead protection area, whichever is greater, within one hundred (100) feet of a treated water ground storage facility and ten (10) miles upstream of a surface water intake;

(j) Schematic flow diagrams and hydraulic profiles showing flow through various plant units drawn on plan sheets the same size as the construction drawings;

(k) Location, dimensions, and elevations of all proposed plant facilities;

(l) Location of all plant piping in sufficient detail to show flow through plant including waste lines;

(m) Location of all chemical feeding equipment, points of application, and sample taps following chemical injection points;

(n) Location of sanitary or other facilities, such as lavatories, showers, toilets, lockers, etc.;

(o) All appurtenances, specific structures, and equipment pertinent to the project such as water plant structures (air relief valves, altitude valves, blowoffs, hydrants, service connections, etc.);

(p) Erosion control structures for wellhead blowoff and elevated and ground storage tank drains;

(q) Adequately detailed drawing of any feature or piece of equipment not otherwise covered or adequately described by the specifications; and,

(r) Protection of the water source, structures, and appurtenances, to include, but not be limited to, fencing, protective housing, or comparable form of security.

F. Specifications.

The title page or cover of the specifications must carry the seal and signature of a professional engineer. Complete, detailed, technical specifications shall be supplied for each proposed project, and shall include, but not be limited to, the following:

- (1) Construction specifications including:
 - (a) A detailed written program for maintaining normal operation of existing facilities during construction with minimal interruption of service;
 - (b) Laying methods and conditions including depth of cover, type of bedding and reaction blocking, and special structural details for water lines installed under storm drains;
 - (c) Pressure and leakage test procedures for new water mains including method of determining maximum allowable leakage;
 - (d) Disinfection procedure for all new or affected water system components to include disinfectant, dosage, contact time, and method for testing the results of the procedure;
 - (e) Well construction method and procedure;
 - (f) Chlorination room construction; and,
 - (g) Other chemical feeding facilities construction;
- (2) Material specifications including:
 - (a) Laboratory facilities and equipment, including sampling taps and their location;
 - (b) Number and design of chemical feeding equipment including make and model, if available;
 - (c) Equipment for sanitary or other facilities including any necessary backflow or back-siphonage protection;
 - (d) Water main and appurtenances schedule and class, including approval status by testing and certification organizations;
 - (e) Make, model, horsepower and performance curves of all pumping equipment; and,
 - (f) Paint coatings.
- (3) Testing and development procedure for new sources.
- (4) Standard specifications.

If a water system or professional engineering firm uses a set of its own standard specifications, such specifications may be submitted to the Department, in duplicate, for approval. Following this approval, no specifications will be required on future project submittals as long as no changes are made. If there are any additions, deletions, or revisions to the approved standard specifications for a particular project submitted, the professional engineer shall either submit three (3) copies of an addendum to the standard specifications covering the changes only, or shall submit three (3) complete copies of specifications for the project in question. Each professional engineer that will be using a standard specification must place his seal and signature on the title page and must place his seal and signature on any revisions.

G. Design Data.

A summary of complete design criteria and design calculations shall be submitted for each proposed project, and shall contain, but not be limited to, the following where applicable:

- (1) Pumping capacity of source;
- (2) Average daily water consumption;
- (3) Number and type(s) of proposed service connections;
- (4) fire flow requirements (refer to Section R.61-58.B for the definition of fire flow);
- (5) The results of a flow test conducted at a location near the proposed connection to the existing system. The results of this flow test shall include static pressure and residual pressure when a known flow, in excess of the demand for the proposed extension, is flowing. The time and date the flow test was conducted, the pipe size, type of pipe, elevation and distance between the test point and connection site shall also be included;
- (6) Basin capacities;

- (7) Retention times;
- (8) Unit loadings;
- (9) Filter area and proposed filtration rate;
- (10) Backwash rate;
- (11) Feeder capacities and ranges;
- (12) Ground storage and transfer pump capacity;
- (13) System storage capacities; and,
- (14) System pressures at maximum instantaneous demand (not less than twenty-five (25) pounds per square inch); or fire flow in addition to peak hourly flow or flushing flow in addition to peak hourly flow (not less than twenty (20) pounds per square inch), whichever is the worst case.

H. Requirements for a General Construction Permit.

(1) A public water system which meets the following criteria may apply for a general permit for the construction of water line extensions.

- (a) The system must have a full-time professional engineer on staff or a professional engineer on retainer.
- (b) The system must have a full-time management and full-time inspection and maintenance staff.
- (c) The system must have a set of design criteria which has been approved by the Department. This criteria shall be at least as stringent as that used by the Department.
- (d) The system must have a set of approved construction specifications for water distribution lines on file with the Department. These specifications must bear the seal and signature of the professional engineer on staff or the professional engineer on retainer.
- (e) The system must have historically demonstrated satisfactory bacteriological and chemical water quality as required by R.61-58.5, R.61-58.10, and R.61-58.11.
- (f) The system must have a satisfactory pressure record as required by R.61-58.4.D(4).
- (g) The system must have implemented and maintained a viable cross connection control program in accordance with R.61-58.7(F);
- (h) The system must have an active inspection program for new water distribution line construction.
- (i) The system must maintain an updated map of the distribution system. This map must include the following, where applicable:
 - (i) Existing water distribution lines;
 - (ii) Location and size of all storage tanks, booster pump stations, pressure reducing valves, master metered connections, and fire hydrants; and,
 - (iii) Location of all water treatment plant(s), surface water intake(s), well(s) and connections to other public water systems; and,
- (j) The system must have a computerized hydraulic model of its distribution system. This model shall include a sufficient number of lines to adequately represent the distribution system. This hydraulic model must be made available for review by the Department upon request.

(2) The application for a general construction permit shall include a completed application form for a permit to construct, submitted in triplicate (one original and two copies), and necessary documentation to show compliance with the criteria specified in R.61-58.1(H)(1). If the system does not have approved construction specifications or design criteria on file with the Department at the time of making application for a general construction permit, the application must include two (2) copies of its standard specifications and two (2) copies of its design criteria.

(3) A general construction permit shall be valid for a period of five (5) years. In order to renew the general construction permit, a new application must be submitted to the Department in accordance with R.61-58.1(H)(2).

(4) The Department may revoke the general construction permit at any time during the five year period for failure to maintain the qualifications as specified in R.61-58.1(H)(1) or failure to comply with the conditions of the permit. Such revocation is subject to appeal in accordance with the Administrative Procedures Act and applicable procedures for contested cases.

(5) The general permit shall apply to the construction of water line extensions only.

(6) For those systems which have a professional engineer on staff the following procedure shall be followed under the general construction permit:

(a) An annual report shall be submitted, in duplicate, to the Department listing all water line extensions constructed during the calendar year. This report shall be submitted no later than January 30th following the year for which the report was prepared. This report shall include the following information for each line extension:

- (i) street name;
- (ii) size(s) and length(s) of line; and,
- (iii) type of customer(s) being served.

(b) If a line extension is for the connection of the distribution system to an additional source of water, the general construction permit will not apply and the system shall make application for a permit to construct in accordance with R.61-58.1(B).

(c) For those projects which are in the eight (8) coastal counties, the system shall obtain approval, prior to construction, from the Office of Ocean and Coastal Resources Management certifying that the project is consistent with the Coastal Zone Management Program.

(d) The system shall maintain, for a minimum of three years, records of all pressure testing and bacteriological analyses conducted in conjunction with each water line extension and make them available to the Department upon request.

(e) No approval from the Department will be required prior to placing any of the water line extensions into service.

(7) For those systems which have a professional engineer on retainer the following procedure shall be followed under the general construction permit:

(a) For all water line extensions greater than twenty-five hundred (2,500) linear feet, two (2) copies of line drawings, to scale, shall be submitted to the Department for permitting. This submittal shall also include a description of what is to be served and a flow test conducted near the point of connection to the existing system. The flow test information shall include the static pressure, flow, residual pressure and date, time, and duration of the test. These drawings shall carry the seal and signature of the professional engineer on retainer. A construction permit shall be issued by the Department prior to construction of the proposed line extension(s). Written approval shall be obtained from the Department prior to placing the water line extension(s) into service; and,

(b) For all water line extensions less than or equal to twenty-five hundred (2,500) linear feet, two (2) copies of line drawings, to scale, shall be submitted to the Department at least ten (10) days prior to construction. This submittal shall also include a description of what is to be served and a flow test conducted near the point of connection to the existing system. The flow test information shall include the static pressure, flow, residual pressure and date, time, and duration of the test. These drawings shall carry the seal and signature of the professional engineer on retainer. No additional construction permit will be required. However, if the Department suspects that there may be a problem with a proposed water line extension, the Department may require additional information to be submitted in order to justify the design. The Department shall be notified in writing within ten (10) days following the date the water line extension is placed into service. This notification shall include two copies of record drawings if the construction differed from the plans submitted under R.61-58.1.H(6)(a) and a copy of the results of all pressure testing and bacteriological analyses conducted in conjunction with the project. No written approval from the Department will be required prior to placing the extension into service.

For those projects which are in the eight (8) coastal counties, the system shall obtain approval, prior to construction, from the Office of Ocean and Coastal Resource Management certifying that the project is consistent with the Coastal Zone Management Program.

(8) The general permit shall include conditions to ensure compliance with the state program for permits to construct in navigable waters.

(9) The general construction permit applies only to the construction of those water lines designed, and owned or operated, by the public water system to which the general permit is issued. Permits for privately owned water lines must be obtained through the Delegated Permit program specified in R.61-58.1(I) or through the permitting process specified in R.61-58.1(B) through (G).

I. Delegated Review Program.

(1) A public water system which meets the following criteria may apply for delegated review authority.

(a) The system must have a professional engineer on staff.

(b) The system must have a full-time management and full-time inspection and maintenance staff.

(c) The system must have a set of design criteria which has been approved by the Department.

(d) The system must have a set of approved construction specifications for water distribution lines on file with the Department. These specifications must bear the seal and signature of the professional engineer on staff.

(e) The system must have historically demonstrated satisfactory bacteriological and chemical water quality as required by R.61-58.5, R.61-58.10, and R.61-58.11.

(f) The system must have a satisfactory pressure record as required by R.61-58.4.D(4).

(g) The system must have implemented and maintained a viable cross connection control program in accordance with R.61-58.7(F);

(h) The system must have an active inspection program for new water distribution line construction;

(i) The system must maintain an updated map of the distribution system. This map must include the following, where applicable:

(i) Existing water distribution lines;

(ii) Location and size of all storage tanks, booster pump stations, pressure reducing valves, master metered connections, and fire hydrants; and,

(iii) Location of all water treatment plant(s), surface water intake(s), well(s) and connections with other public water systems; and,

(j) The system must have a computerized hydraulic model of its distribution system. This model shall include a sufficient number of lines to adequately represent the distribution system. This hydraulic model must be made available for review by the Department upon request.

(2) The application for delegated review authority shall include a completed application form for a permit to construct, submitted in triplicate (one original and two copies), and necessary documentation to show compliance with the criteria specified in R.61-58.1(I)(1). If the system does not have approved construction specifications or design criteria on file with the Department at the time of making application for delegated review authority, the application must include two (2) copies of its standard specifications and two (2) copies of its design criteria.

(3) The Department may revoke a system's delegated review authority at any time for failure to maintain the qualifications as specified in R.61-58.1(I)(1) or failure to comply with the permitting procedures under the delegated review program. Such revocation is subject to appeal in accordance with the Administrative Procedures Act for contested cases.

(4) The delegated review program applies only to the permitting of line extensions which are not subject to the requirements for demonstrating viability as specified in R.61-58.1.B(4) and connecting to the system which has the delegated review authority.

(5) The procedure for obtaining a permit to construct under the delegated review program is as follows:

(a) The professional engineer for a water line extension project may submit plans and specifications and design data to the public water system with delegated review authority for review in lieu of submitting to the Department an application for a permit to construct as specified

in R.61-58.I(B)(2). The delegated review authority shall review the project for compliance with its design criteria and construction specifications.

(b) Following a satisfactory review of the project by the delegated review authority, the system shall submit the following information to the Department for permitting:

(i) A transmittal letter, signed by the professional engineer on staff, which clearly states the project is being submitted under the delegated review program. This letter shall also state that the project has been reviewed and complies with the system's design criteria and construction specifications;

(ii) A completed application form for a permit to construct in duplicate (the original and one (1) copy);

(iii) Two (2) sets of plans bearing the seal and signature of the design engineer;

(iv) One (1) copy of the flow test results from a location near the tie-on site. This must include the static pressure and residual pressure while flowing in excess of the demand for the proposed extension. The time, date and duration of the flow test, the size of pipe, type pipe and distance to the tie-on site must be included;

(v) One (1) copy of design calculations indicating a minimum pressure of twenty-five (25) pounds per square inch must be maintained everywhere in the distribution system during instantaneous demand or twenty (20) pounds per square inch during fire flow plus peak hourly flow; and,

(vi) Two (2) copies of a site location map.

(c) Where applicable, the Department will review the project for consistency with the Coastal Zone Management Plan and for construction in navigable waters prior to issuing a permit to construct.

(d) Written approval must be obtained from the Department prior to placing the water line extension into service.

J. Revisions to Approved Plans.

Any deviations from approved plans or specifications which could potentially effect capacity, hydraulic conditions, operating units, the functioning of water treatment processes, or the quality of the water to be delivered, shall be approved by the Department, in writing, before such changes are made. A revised application in accordance with R.61-58.1(B) will be required.

K. Requirements for Obtaining Approval to Place Permitted Construction into Operation.

(1) Newly-constructed facilities shall not be placed into operation until written approval is issued by the Department, except where it is allowed by a general construction permit. Upon completion of permitted construction, the professional engineer shall make arrangements with the Department for final inspection. Prior to this inspection, the professional engineer shall submit to the Department a letter certifying that construction is complete and in accordance with the approved plans and specifications. This letter must specifically identify the project by permit number. If the project was not completed in accordance with the approved plans and specifications, the professional engineer shall so state and shall outline any deviations to the permitted project. No written approval shall be issued to place a drinking water construction project into operation until written approval is obtained to place any associated wastewater construction into operation. The following information, where applicable, shall be submitted with the professional engineer's letter of certification:

(a) Results of chemical, physical, radiological, and bacteriological analyses of new sources and/or treated water. These analyses shall be performed by a certified laboratory.

(b) Results of bacteriological analyses following disinfection, including chlorine residuals at the time of collection, which have been conducted within thirty (30) days of the request for final approval. These analyses shall be performed by a certified laboratory.

(c) Results of pressure/leakage test conducted on water lines;

(d) Record drawings of construction if the construction deviated from that approved;

(e) Completed Water Well Record form;

(f) Geophysical/mechanical well logs;

- (g) Results of pumping test as required by R.61-58.2(B)(12).
- (h) Letter of acceptance from organization responsible for operation and maintenance (must be the same as shown on the application for permit to construct form);
- (i) Paint coating(s) used for water storage tank(s);
- (j) Copy of recorded legal easement(s) and/or deed restriction(s) for protection of well pollution free radius;
- (k) Proof of registration with the S. C. Public Service Commission for new privately owned utilities and homeowner associations;
- (l) Proof of testing of all backflow prevention assemblies installed; and,
- (m) Copies of any information specified in a special condition of a Department construction permit.

(2) Failure to obtain written approval from the Department prior to placing any newly constructed drinking water facilities into operation is a violation of the Act (Code Section 44-55-40) and is subject to an enforcement action by the Department. Where a person has failed to obtain a permit to construct, an application for permit must be submitted to include record drawings carrying the seal and signature of a professional engineer.

L. Drinking Water Dispensing Stations and Vending Machines.

(1) Any person or public water system desiring to make vended or dispensed water available to the public shall obtain approval from the Department prior to installation and shall obtain approval to operate before placing it into use. All water dispensing stations or vending machines must utilize water from an approved public water system. Each dispensing station or vending machine which provides further treatment is considered a separate public water system and must comply with all applicable requirements for public water systems. Before any approval can be issued technical information on machines and treatment equipment including make and model, rates of filtration, maximum daily output, and method of disinfection; and, complete plans and specifications for each machine or treatment unit shall be submitted to the Department.

(2) Approval is issued for an individual machine at a particular location, connecting to a known public water system. Machine replacement or relocation must be approved by the Department.

(3) A final inspection, total coliform clearance sample and a written approval from the Department is required before placing a machine or dispensing station into operation.

M. Bottled Water.

1. All sources within the state which are used in the manufacturing of bottled water shall be either permitted in accordance with R.61-58.1 or from an existing approved public water system.

2. If an out-of-state source of water is used by a bottled water manufacturing plant located within South Carolina, that source must be approved by the Department prior to use.

3. All treatment used in the manufacturing of bottled water shall be permitted in accordance with R.61-58.1.

N. Request for Review of Permit Decisions.

1. An applicant may request that the director of the Department's water supply permitting division review any construction or operating permit decision within 15 (fifteen) days of receipt of the decision. The request shall be in writing and include a detailed justification of the reasons for the review.

2. The director shall respond in writing to the request within 15 (fifteen) days of receipt of the written request. This response may include, but not be limited to, a request for additional information, scheduling of a meeting to discuss the permit decision, or the issuance of a final permit decision.

3. The applicant may appeal the director's final decision on the permit in accordance with R.61-58(C).

O. Operating Permits.

(1) Public water systems which meet any of the following conditions shall obtain and maintain an operating permit from the Department:

- (a) A system which has its own source of water (i.e., well or surface water treatment plant);
- (b) A system which provides treatment;
- (c) A system which sells water to any person; or,
- (d) A system which is a carrier which conveys passengers in interstate commerce.

(2) For existing systems, the owner of a system shall complete and submit an application form for an operating permit within ninety (90) days of receipt of written request from the Department. The Department will provide the owner with a copy of the application form with the written request.

(3) Any person making application for a permit to construct a new public water system which meets any of the conditions specified in R.61-58.1.O(1) will not be required to submit a separate operating permit application. The Department will issue an operating permit for the system at the same time the permit to construct is issued. The operating permit will be contingent upon the permittee obtaining approval from the Department to place the newly constructed facilities into operation in accordance with R.61-58.1.K.

(4) For existing systems, the Department shall provide a draft of the operating permit to the applicant for comment, for at least a thirty (30) day period. If the applicant gives written notice of concurrence with the draft permit, the thirty (30) day comment period may be waived. After consideration of any comments received from the applicant, the Department will issue the operating permit. The operating permit will become effective on that date unless a review of the decision is requested in accordance with R.61-58.1(N), or appealed in accordance with R.61-58.C.

(5) The Department may modify an operating permit at any time to include any new promulgated requirements of the Act or these Regulations, to address requirements necessary to ensure compliance with the State Safe Drinking Water Act and these regulations, to include any approved or permitted construction modifications to the system, or to modify a compliance schedule. Permit modifications will be issued in accordance with R.61-58.1.O(3).

(6) The permittee may request a modification of the operating permit at anytime with adequate justification. The permittee shall complete and submit to the Department an operating permit application form along with a detail justification for the modification(s) requested. Permit modifications will be issued in accordance with R.61-58.1.O(3).

(7) An operating permit is non-transferable, except with prior approval of the Department. The permittee shall submit written notification to the Department at least 30 days in advance of the proposed transfer. This notification shall include an operating permit application form which has been completed by the proposed new owner of the system. The Department may request on a case-by-case basis that the proposed new owner of the system submit a business plan which shows how the system will be managed to ensure its long-term viability. If the Department approves of the transfer, a new operating permit will be issued to the new owner of the system in accordance with R.61-58.1.O(3).

(8) An operating permit is non-transferable, except with prior approval of the Department. The permittee shall submit written notification to the Department at least 30 days in advance of the proposed transfer. This notification shall include an operating permit application form which has been completed by the proposed new owner of the system. The Department may request on a case by case basis that the proposed new owner of the system submit a business plan which shows how the system will be managed to ensure its long term viability. If the Department approves of the transfer, a new operating permit will be issued to the new owner of the system in accordance with R.61-58.1.O(4).

(9) If an existing water system is out of compliance with any of the requirements of the Act or these Regulations, the Department may include in the operating permit a schedule for achieving compliance with such requirements.

(10) Once the permittee has satisfactorily complied with the requirements of R.61-58.1.O(9) and necessary corrections have been made to the water system, the permittee may request that the Department revise the sanitary survey rating on the operating permit.

(11) Once the permittee has satisfactorily complied with the requirements of R.61-58.1.O(10) and necessary corrections have been made to the water system, the permittee may request that the Department revise the sanitary survey rating on the operating permit.

(12) The operating permit shall include a condition that requires the submission of a business plan to the Department within six months following the issuance of an “unsatisfactory” rating on any future sanitary survey.

(13) The Department may issue general operating permits for groups of systems with similar operating requirements. The Department may deny coverage under the general operating permit to any system which is not in compliance with the requirements of the Act or these Regulations. The Department may also deny coverage under the general operating permit where specific requirements are necessary to obtain and/or maintain compliance with the Act or these Regulations.

(14) If an existing public water system is divided into two or more smaller water systems, each of the smaller water systems shall comply with the water quality monitoring requirements of the water system prior to it being divided.

HISTORY: Amended by State Register Volume 19, Issue No. 7, eff July 28, 1995; State Register Volume 22, Issue No. 6, Part 2, eff June 26, 1998; State Register Volume 26, Issue No. 5, Part 1, eff May 24, 2002; State Register Volume 27, Issue No. 4, eff April 25, 2003.

61-58.2. Groundwater Sources and Treatment.

Table of Contents

- A. Applicability
- B. Groundwater Development
- C. General Design Requirements
- D. Groundwater Treatment
- E. Chemical Application
- F. Waste Handling and Disposal

A. Applicability.

This regulation applies to all new construction and all expansions or modifications of existing public water systems. If the Department can reasonably demonstrate that safe delivery of potable water to the public is jeopardized, a system may have to upgrade its existing facilities in order for an expansion or modification to meet the requirements of this regulation. This regulation prescribes minimum design standards for the construction of groundwater sources and treatment facilities.

B. Groundwater Development.

All wells must be constructed by a certified well driller.

(1) Quantity—

(a) A minimum of two (2) independent sources of groundwater shall be provided for all community water systems serving fifty (50) or more taps or one hundred fifty (150) or more people. Systems with an additional source (Surface Water Plant or Master Meter) will not be required to have two groundwater sources.

(b) The total developed groundwater source capacity shall equal or exceed the design maximum day demand without pumping more than sixteen (16) hours a day. With the largest producing well out of service, the capacity of the remaining well(s) pumping twenty-four (24) hours a day shall equal or exceed the design maximum daily demand, except those systems requiring only one well. The capacity from an additional source (Surface Water Plant or Master Meter) will be included in the quantity analysis. However, emergency and stand-by wells will not be included in the quantity analysis.

(2) Quality—Where the water quality does not meet the drinking water standards established in R.61-58.5, appropriate treatment designed in accordance with R.61-58.2 shall be provided.

(3) Site Considerations—

(a) Location—

(i) The location of the public well shall be at least one hundred (100) feet from all potential pollution sources except where the professional engineer or professional geologist can justify a

lesser distance based in part on hydrogeological conditions or special well construction techniques or where the pollution source is designed in such a manner as to prevent the release of contaminants to the environment. A greater pollution free radius shall be required where water from water table aquifers will be used. A Wellhead Protection Area Inventory must be performed based on the location and expected yield of the proposed well.

(ii) The well location shall be at least fifty (50) feet from all surface water bodies including drainage ditches. The site must be such that the wellhead can be protected above the one hundred (100) year flood plain. Special construction techniques may be required by the Department in any area which is generally subject to flooding and the professional engineer must demonstrate to the satisfaction of the Department that the site selected is the best available. No well(s) shall be constructed in such proximity to existing wells as to cause unwarranted well interference.

(b) Easement—Once the pollution free radius is established according to R.61-58.2(B)(3)(a), an appropriate easement, ownership or deed restriction to ensure the required pollution-free radius shall be filed at the county courthouse. A copy of the deed must be submitted to the Department prior to placing the well into operation. If a right-of-way easement is needed to maintain access to the well, such an easement shall be filed at the county courthouse and a copy submitted to the Department prior to placing the well into operation.

(c) Special Considerations—Wells located within two hundred (200) feet of a body of water, or constructed such that water is being drawn from less than fifty (50) feet in depth, or constructed such that the filter material extends to less than fifty (50) feet below grade, must conduct special monitoring required in R.61-58.2(B)(14)(c). This monitoring must be conducted within one year of receiving the permit to operate. If the well is found to be under the direct influence of surface water, treatment must be added and monitoring conducted in accordance with the requirements of R.61-58.10, Filtration and Disinfection.

(4) All materials and products installed in a public water system after December 31, 1995, which comes into direct contact with drinking water during the treatment, storage, transmission or distribution of the water, shall be certified as meeting the specifications of the American National Standard Institute/National Sanitation Foundation Standard 61, Drinking Water System Components—Health Effects. The certifying party shall be accredited by the American National Standards Institute.

(5) Drilling and Sampling—

(a) Driller's log—A driller's log shall be completed for each well and shall include a depth reference point, the depth of each formation change, a description of each formation including color, mineralogy, rock type, grain size, and any other observations which may have a bearing on the final construction of the well. Special attention is required in the case of Type I wells in that the log shall denote the depth, thickness, and approximate flow of each fracture or fracture zone as measured by discharge during air circulation hammer/rotary drilling. The Department must be provided two (2) copies of the driller's log prior to the construction of the pumping, treatment or distribution facilities associated with the well or with the engineer's certification letter if the project is permitted in one step.

(b) Geophysical/Mechanical logs—Where required by the Department, two (2) copies shall be provided to the Department prior to the construction of the pumping, treatment or distribution facilities associated with the well or with the engineer's certification letter if the project is permitted in one step.

(c) Penetration rate log—Where required by the Department, two (2) copies shall be provided to the Department prior to the construction of the pumping, treatment or distribution facilities associated with the well or with the engineer's certification letter if the project is permitted in one step.

(d) Sieve Analysis For Type II and III Wells—Where required by the Department, two (2) copies of sieve analysis results shall be provided to the Department prior to the construction of the pumping, treatment or distribution facilities associated with the well or with the engineer's certification letter if the project is permitted in one step.

(e) Drilling fluid control program—Where drilling water is used, it shall contain no dangerous materials, shall be disinfected and shall meet the drinking water standards established in R.61-58.5. All other drilling fluids and additives used shall comply with recognized industry standards and practices for the construction of drinking water wells, and shall be applied and used as prescribed by the manufacturer. Toxic and/or dangerous substances shall not be added to drilling fluid. Non-potable surface or ground water shall not be used as a drilling fluid.

(6) Well Casing Selection and Installation—

(a) Casing selection - New casing which bears mill markings and which conform to standard specifications (ASTM A-53) for water well pipe shall be used. Thermoplastic casing and couplings which meet standard specifications (ASTM F-480) and which are approved by the National Sanitation Foundation may be used for Type II, III and IV wells which will not exceed three hundred (300) feet in depth. Unless specifically approved by the Department, thermoplastic casing shall not be used for Type I wells. No material containing more than eight (8) percent lead by weight shall be used in the completed well.

(b) Method of installation—The following methods shall be used:

<u>Well</u>	<u>Casing installed by</u>
Type I	Driving to refusal in firm bedrock. Where firm bedrock is encountered shallower than twenty (20) feet a minimum casing length of twenty (20) feet will be required.
Type II and III	Lowering the casing string in the pre-drilled hole so as not to damage any parts of the screen or casing.
Type IV	Driving into firm limestone where metal casing is used or by placing into firm limestone where thermoplastic casing is used.

(c) Method of joining—Casing lengths shall be joined in alignment and made water tight by an appropriate method for the material used such that the resulting joint shall have the same structural integrity as the casing. Threaded and coupled joints shall be API or equivalent and shall be firmly and securely seated. PVC solvent cement and bell end or coupled joints shall meet ASTM standard specifications.

(d) Sanitary protection of well—The well shall be protected at all times during construction. The casing shall be sealed with a suitable flanged, threaded, or welded cap or compression seal upon completion. The outside casing shall be sealed to, and centered in, a reinforced concrete pad having a minimum strength of two thousand (2000) pounds per square inch, a minimum radius of three (3) feet and a minimum thickness of four (4) inches. The concrete pad shall be constructed with a slope so that water will drain away from the casing. The top of the outside casing shall extend at least twelve (12) inches above the concrete pad. There shall be no openings in the casing wall below its top except for water level measurement access ports or vents. Such openings shall be sealed water tight prior to use of the well. Any well which is to be temporarily removed from service, or which is completed for a period of time prior to being placed in service, shall be capped with a watertight cap and protected from vandalism.

(e) Well identification plate—Every well shall be equipped immediately after completion of the drilling, and prior to issuance of a permit to operate with an identification plate.

(i) The identification plate shall be constructed of a durable, weatherproof, rustproof metal or equivalent material.

(ii) The identification plate shall be securely attached to the well casing or concrete pad around the casing where it is readily visible.

(iii) The identification plate shall be stamped with a permanent marking to show the following information:

(A) Drilling contractor and registration number;

(B) Date well completed;

- (C) Total depth of well (in feet);
- (D) Casing: Depth (in feet), Inside Diameter (in inches);
- (E) Screened intervals (of screened wells);
- (F) Filter-pack interval (of wells with artificial filter-pack);
- (G) Yield expressed in gallons per minute (gpm), or specific capacity expressed in gallons per minute per foot of drawdown (gpm/ft.-dd);
- (H) Static water level and date measured; and,
- (I) Latitude and longitude (to the nearest second).

(7) Well Grouting—The Department shall be notified a minimum of three (3) days prior to the time of grouting.

(a) Grouting materials—All wells shall be grouted with a minimum of sand-cement, bentonite-cement mixture or neat cement. The sand-cement or neat cement mixture shall be composed of not more than two (2) parts by weight of sand to one (1) part of cement with not more than seven (7) gallons of clean water per bag (one cubic foot or 94 pounds) of cement. The bentonite-cement mixture shall be composed of three (3) to five (5) pounds of bentonite mixed with seven (7) gallons of clean water per bag (one cubic foot or 94 pounds) of cement.

(b) Method of installation of grout—Grout material shall be placed by tremie pipe, either by pouring or forced injection, after water or other drilling fluid has been circulated in the annular space sufficiently to clear all obstructions. There shall be a minimum annular space of three (3) inches for gravity feed and one and one-half (1.5) inches for forced injection between the outside surface of the casing and the formation. The minimum size tremie pipe shall be two (2) inches inside diameter for gravity feed and one (1) inch inside diameter for forced injection. When placing the grouting material, the tremie pipe shall be lowered to the bottom of the zone to be grouted and raised slowly as the grout material is introduced. The tremie pipe shall be kept full continuously from start to finish of the grouting procedure, with the discharge end of the tremie pipe being continuously submerged in the grout until the zone to be grouted is completely filled. The grout shall be allowed to properly cure before construction may be resumed.

More sophisticated methods of installation of grout may be used but care must be taken to ensure these are in accordance with standard procedures.

(c) Length of grout—The minimum length of grout for sanitary protection shall be:

<u>Well</u>	<u>Grouted from surface</u>
Type I	To at least fifty (50) feet or firm bedrock, whichever is less. However, where bedrock is encountered at less than twenty (20) feet, at least twenty (20) feet of casing shall be used and the entire length of the casing shall be grouted.
Type II and III	To fifty (50) feet or the first low permeability stratum (clay, marl, etc.), or to within ten (10) feet of the upper most screen when no low permeability stratum is encountered, whichever is greater.
Type IV	To fifty (50) feet or firm limestone or firm marl, whichever is less. However, where limestone or firm marl is encountered at less than twenty (20) feet, at least 20 feet of casing shall be used and the entire length of the casing shall be grouted.

The Department may require an additional length of grout where warranted by site, geological and/or water quality conditions.

(d) Centralizers—For Well Types II and III centralizers shall be attached to the outer casing at the bottom of the upper zone to be grouted and at the top and bottom of other critical grouting points such as zones of unsuitable water quality as indicated by test hole information.

(8) Well Screens—This part is applicable to Well Types II and III only.

(a) Filter type selection—Where a non-homogeneous aquifer, having a uniformity coefficient less than three (3.0) and an effective grain size less than one tenth (0.1) inches is to be screened, an artificial filter shall be used as described in R.61-58.2(B)(9).

(b) Screen-type selection—The screen specified shall have controlled uniform slot size, have structural integrity, and be of a type which will allow a well entrance velocity which does not exceed six (6) feet per minute. The use of non-metallic screens will be reviewed on a case-by-case basis. The use of non-metallic screen settings below two hundred (200) feet will be allowed only when recommended by the manufacturer.

(c) Screen slot size—The screen slot size shall be based on sieve analysis, industry standards, and good engineering practice; and/or shall meet the sand content limits outlined in R.61-58.2(B)(11)(b).

(d) Screen length—Screen of sufficient length shall be installed to obtain an entrance velocity not to exceed six (6) feet per minute.

(e) Screen location—Screen settings located in unconfined water-table aquifers shall be approved only on a case-by-case basis where justification concerning pollution-free radius, treatment, etc. is provided.

(f) Method of screen installation—The screen shall be provided with such fittings as are necessary to seal the top tightly to the casing and to close the bottom, as defined in R.61-58.2(B)(8)(g) and (h). If the screen is telescoped inside the casing, a packer seal made for this purpose, or an approvable substitute, shall be lapped at least twelve (12) inches into the casing. If this screen is attached to the casing prior to lowering, centralizers shall be used and a suitable coupling shall be provided or the screen shall be welded to the casing.

(g) Method of joining screen to screen—Screen sections for a single interval shall be joined by threaded and coupled joints, socket-type fittings and solvent welding, or electric arc or acetylene welding. Welding rods and methods recommended by the screen manufacturer shall be employed. Resulting joint(s) must be straight, sand tight, and retain one hundred (100) percent of the screen strength.

Blank spacers for multiple interval screens shall be of compatible material with the screens or casing. They shall be joined to the screen by threaded and coupled joint, socket-type fittings, solvent welding, or electric arc or acetylene welding using materials and procedures specified in R.61-58.2(B)(6)(c). The resulting joints shall be straight, sand tight, and retain one hundred (100) percent of the screen strength.

(h) Method of connecting screen to casing—The connection between the screen and casing shall be by a neoprene or rubber seal especially made for this purpose, or by threaded and coupled joints, socket fittings and solvent welding, or electric arc or acetylene welding using materials and procedures listed in R.61-58.2(B)(6)(c). The resulting joints must be straight, water tight, and retain one hundred (100) percent of the screen strength.

(i) Methods of sealing bottom—The bottom of the screen shall be sealed with bagged cement or a threaded or welded plug made of compatible material with the screen body.

(9) Well Filter Construction (Artificial)—This part is applicable only to Type III wells.

(a) Filter material—Clean, well-rounded quartz particles free of limestone, clay, organic matter or other unsuitable materials shall be used.

(b) Selection of artificial filter grain size and screen aperture size—When an artificial filter is necessary, the filter grain size shall be determined from sieve analysis of the formation to be screened. The screen aperture shall be of such size as to retain between eighty-five (85) and one hundred (100) percent of the filter material. The drill hole diameter shall be carefully controlled so that the thickness of the filter medium ranges from a minimum of three (3) inches to a maximum of eight (8) inches.

(c) Length of artificial filter—The filter material shall, at a minimum, extend below the lowest screen for a distance two and a half (2.5) times the largest diameter of the well casing to the same distance above the highest screen. Where zones of inferior water quality are to be avoided, the annular space opposite the inferior zones shall be grouted in accordance with R.61-58.2(B)(7)(a) and (b).

(d) Delivery and storage of filter material—The filter material shall be protected from the weather and any contamination by bagging, or covering with plastic or canvas until used. If no

protective cover is placed on the ground under the filter material, the layer in contact with the ground shall not be used.

(e) Method of installation of filter material—The filter material shall be placed with a disinfected fluid. For wells less than fifty (50) feet in depth with a short screen (5 to 10 feet), the filter material may be gravity fed from the surface if the annular space is at least six inches. For wells deeper than fifty (50) feet, a tremie pipe shall be required.

(10) Well Plumbness and Alignment—The completed well shall be sufficiently plumb and straight so that there will be no interference with installation, alignment, operation, or removal of the test or permanent pumps.

(11) Well Development—Proper well development is demonstrated by the turbidity of the water produced by the well and its sand content.

(a) Turbidity—The water produced by a completed well must have a turbidity of less than five (5.0) nephelometric turbidity units (NTU) unless it can be demonstrated that the turbidity is due to the natural water quality of the aquifer.

(b) Sand content—The maximum sand content shall be five (5) milligrams per liter or twenty (20) milligrams per gallon in the completed well.

(12) Well Testing for Performance—The Department shall be notified at least three (3) days prior to the time of the pumping test. The pumping test shall not be conducted until the well has been adequately developed.

(a) Type of pumping test performed—Pump tests to fully evaluate the yield and specific capacity shall be performed on all newly constructed wells and shall be performed for a minimum of twenty-four (24) hours at the design or maximum capacity of the well. The test procedure shall be based on good hydro-geologic practice.

(b) Aborted tests—Whenever there is an interruption in pump operation for a period greater than one percent of the elapsed pumping time, there shall be a suspension of the test until the water level in the pumped well has recovered to the static level. The test must be restarted and run for the full twenty-four (24) hour period.

(c) Location of discharge - Water shall be discharged so that it will not affect test results and so that no damage by flooding or erosion is caused to the chosen drainage structure or disposal site. The location of the discharge point shall be shown on the site plan and precautions must be taken to ensure the protection of flora and fauna.

(d) Record of tests—Accurate records shall be kept of the test along with weather conditions and other pertinent information. Two (2) copies shall be furnished to the Department prior to construction of the pumping, treatment or distribution facilities associated with the well or with the engineer's certification letter if the project is permitted in one step. The records shall also be available for inspection at any time during the test. At a minimum the record shall include the following information:

(i) time the test was started;

(ii) method of measuring the pumping rate and water level;

(iii) pumping rate and water level measurements every 15 minutes for the first three (3) hours and at least hourly for the remainder of the test;

(iv) water level measurements every fifteen (15) minutes for the first three (3) hours following the end of pumping and hourly thereafter; and,

(v) name of the person(s) conducting the test.

(e) Measurement of water levels—The method of taking water level measurements shall have an accuracy to within plus or minus one tenth (0.1) of a foot. The air line method, steel tape method, or electric sounder method may be used according to proper procedures.

(13) Well Disinfection—

(a) Scheduling disinfection—The well shall be disinfected at the following times during construction:

(i) The well shall be disinfected as soon as construction of the well and cleaning procedures have been completed. All oil, grease, soil, and other materials which could harbor and protect bacteria from disinfectants shall be removed from the well. Unless prior approval is obtained for employing chemicals or unusual cleaning methods, the cleaning operation shall be carried out by pumping and swabbing only.

(ii) The well shall be disinfected after completion of the performance testing and sampling. The well shall be capped in accordance with R.61-58.2(B)(6)(d) and shall be protected from vandalism until the permanent pump is installed.

(iii) The well shall be disinfected after installation of the thoroughly scrubbed and cleaned permanent pump.

(b) Disinfectants—Chlorine disinfectant shall be delivered to the site of the work in original closed containers bearing the original label indicating the percentage of available chlorine. The disinfectant shall be recently purchased (chlorine compounds in dry form shall not be stored for more than one year and storage of liquid compounds shall not exceed 60 days). During storage, disinfectants shall not be exposed to the atmosphere or to direct sunlight. The quantity of chlorine compounds used for disinfection shall be sufficient to produce a minimum of fifty (50) milligrams per liter available chlorine in solution when mixed with the total volume of water in the well.

(c) Disinfection procedure—For each disinfection, a reliable means shall be provided for ensuring that the disinfecting agent is uniformly applied throughout the entire depth of the well including the casing, pipes and wiring above the water level. The disinfection shall be in accordance with current AWWA Standards for disinfection of wells.

After the contact period, the well shall be pumped to clear it of the disinfecting agent. The disposal point for the purged water shall be selected so as to avoid damage to aquatic life or vegetation.

(14) Water Samples and Analyses—All samples shall be appropriately identified by the well identification number assigned by the Department, date, and time and shall include the name of the sample collector, contractor and owner. The samples shall be analyzed by a certified laboratory. Test results shall be provided to the Department prior to the construction of the pumping and treatment facilities (if applicable) or with the engineer's certification letter if the project is permitted in one step.

(a) Bacteriological analysis—Prior to sampling, the well shall be pumped until the chlorine residual is non-detectable. Two consecutive samples of water shall be collected at least twenty-four (24) hours apart and be analyzed for total coliform bacteria. The results of both samples must show the absence of total coliform bacteria using membrane filter methodology. The measured chlorine residual and non-coliform growth must also be reported. If the non-coliform growth is greater than eighty (80) colonies per one hundred (100) milliliters, the sample result will be deemed invalid and must be repeated. All samples must be analyzed by a laboratory certified by the Department. The Department may request that heterotrophic plate count analyses be conducted on a case-by-case basis where construction, development, or disinfection problems are suspected.

(b) Chemical and radiological analysis—Representative clear samples shall be properly collected and preserved and shall be analyzed by a certified laboratory. The sample shall be analyzed for all contaminants listed in R.61-58.5 and all other parameters needed to determine the aggressiveness of the water to include, pH, total alkalinity, calcium, hardness, total dissolved solids, temperature, and shall be delivered to the laboratory no more than thirty (30) hours after its collection. The pH and temperature measurements shall be made in the field using certified methodology.

(c) Special monitoring for direct surface water influence—For those wells meeting the requirements of R.61-58.2(B)(3)(c), and for any other well deemed necessary by the Department because of location, depth, testing analysis, or other pertinent information, the following special monitoring must be conducted:

(i) quarterly analyses, for a period of one (1) year, of the untreated well water for total and fecal coliform bacteria;

(ii) analyses for pH, turbidity, temperature, and conductivity before and after two or more heavy rainfall events (at least 2 inch over a 24 hour period); and,

(iii) where the above analysis indicates a possible problem, microscopic particulate analysis must be conducted.

If these analyses indicate that the well is under direct surface water influence, treatment must be added and monitoring conducted in accordance with R.61-58.10 or the well must be abandoned in accordance with R.61-58.2(B)(15).

(15) Permanent Well and Test Hole Abandonment—All wells and test holes that are not completed as a production, monitoring or observation well shall be properly abandoned. Abandonment of these wells shall be performed by a certified well driller.

(a) Aquifer sealing materials—The well to be abandoned shall be filled with neat cement, sand-cement, bentonite-cement or concrete. The neat cement, sand-cement or bentonite-cement mixtures shall be as specified in R.61-58.2B(7)(a).

(b) Placement of sealing material—Sealing materials used in abandonment operations shall be placed in such a way as to avoid segregation or dilution of the sealing materials. Dumping sealing material from the top shall not be permitted. Special consideration shall be given to the following:

(i) the abandonment of flowing artesian wells;

(ii) a borehole or well which is to be abandoned due to contamination shall be considered a special case, and the method of filling and sealing such wells shall be subject to individual review and prior written approval by the Department.

(iii) In the sealing of a double or multiple cased well, the certified well driller shall submit, for prior approval, a drawing thereof with a description of the proposed procedure and materials to be used to completely and permanently seal both the well and any column of filter pack that extends to the ground surface.

(iv) Bridging for deep wells—Very deep wells that do not require complete filling for sanitary protection may be backfilled with clean sand or gravel to the depth appropriate for the bottom of the plug of sealing materials. Where open casing (types II or III wells) or open borehole (types I or IV wells) is to remain below the sealed depth, a temporary bridge or plug made of inorganic materials (e.g., metal, cement) or manufactured devices specifically designed for this purpose in well construction and made of plastic or other elastic materials (e.g., neoprene, rubber) may be used to support the column of sealing materials until they cure and bond to the casing or borehole. The column of sealing materials is installed above the temporary bridge.

In Type I or IV wells, the column of permanent sealing materials may be set with the bottom at least ten (10) feet below the top of firm bedrock or limestone and extending up to within five (5) feet of the ground surface. The casing may be removed if desired and the borehole abandoned by grouting instead. The upper most five (5) feet may be filled with soil suitable for the intended land use.

In Type II or III wells, the sealing materials shall extend down to at least fifty (50) feet below ground surface, except that the uppermost five (5) feet of the borehole may be filled with soil suitable for the intended land use. Casing may be removed, if desired, and the borehole abandoned by grouting.

(v) In abandoning all new wells (test wells, wells of insufficient yield, unacceptable water quality, etc.) the casing must be properly installed with the appropriate grouted material or else removed and the borehole abandoned by grouting.

(vi) Contaminated wells—wells tapping multiple aquifers of different hydrostatic heads or wells tapping multiple zones of significantly different water quality must be abandoned in a manner such that contaminated or lower quality water does not migrate through the abandoned well or borehole and such that ongoing large vertical transfers of water between aquifers, of any quality, do not occur. The methods proposed for sealing such wells shall be reviewed and will require prior written approval by the Department, completely filling an uncased borehole with sealing materials shall be acceptable without prior approval.

(vii) In sealing a double wall or multiple cased well, the certified well driller shall submit a drawing with a description of the proposed procedure.

(c) Well abandonment records—Before the equipment is removed from the site, the exact location of the abandoned well or hole shall be accurately surveyed and a record made to the

location with respect to several fixed reference points. All information relative to the abandonment procedures, the location, depth, and diameter of the well or hole shall be supplied in writing to the owner and the Department.

(16) Well Head Piping and Pumping Facilities.

(a) General Requirements:

(i) A sanitary seal must be provided on the top of the well casing. A pressure gauge and air line or other method for readily measuring the water level in the well shall also be provided.

(ii) A casing vent elbowed downward must be provided for the well casing a minimum of eighteen (18) inches above the well house floor (except on packer jet wells). The vent can be gooseneck type with twenty-four (24) mesh screen over the opening or manufactured slotted pipe with effective opening of .024 inches or smaller.

(iii) A check valve shall be provided on the pump discharge above the top of the casing. For jet pumps, no check valve is required in the main line but a back-flow/back-siphonage device must be provided on blow offs and sample cocks.

(iv) A sampling tap must be provided for raw water sampling downstream of the check valve and prior to any chemical injection point. If chemical feed is provided at the well head, a second sample tap shall be provided downstream of the last injection point. This second sampling tap shall be located following adequate mixing of the chemical(s), but prior to any storage tank. A static in-line mixer may be required to ensure that adequate mixing of the chemical(s) has taken place prior to the sampling tap.

(v) Adequate control switches, etc., for the pumping equipment must be provided. A pressure relief valve must be provided and shall not be separated by a valve from the controlling device.

(vi) A flow meter shall be provided on:

(A) each well serving a community water system;

(B) each well serving a non-transient non-community water system;

(C) each well which is equipped with treatment; and,

(D) any other public water supply well where the yield of the well, while pumping against the normal working pressure of the system, cannot be easily measured from the blow-off using a bucket and stopwatch or by some other readily accessible means of measuring flow.

The flow meter shall be capable of measuring instantaneous and totalized flow.

(vii) Adequate support for the well pump and drop pipe must be provided.

(viii) An hour meter shall be provided to record the elapsed run time of each well pump which is required to have a flow meter.

(ix) A valved blow-off shall be provided and located prior to any chemical feed but downstream of the flow meter.

(x) A manual control switch shall be provided for each well pump.

(xi) All electrical wiring shall be in conduit and meet the requirements of the National Electric Code.

(xii) Each well pump station must have a sign on the door with a twenty-four (24) hour telephone number for emergencies.

(xiii) Wells or well pump stations in pits are prohibited.

(xiv) All wells shall be readily accessible at all times for inspection, maintenance and sampling. Also, well houses shall be constructed in a manner and of material that will allow one person easy access to the sampling tap(s) and the well head piping for inspection, maintenance and sampling.

(b) Turbine pumps—Drilled wells with the prime mover mounted on the casing (Turbine pumps) shall:

(i) Have the casing equipped with a flange or suitable sanitary seal;

(ii) Have the casing firmly connected to the pump structure or have the casing inserted into a recess extending at least one inch into the base of the pump if a watertight connection is not provided;

(iii) Have the base of the pump not less than twelve (12) inches above the pump room floor or apron;

(iv) Have the pump foundation and base designed to prevent water from coming into contact with the joint between the casing and the prime mover; and,

(v) Have an air release valve installed on the discharge pipe upstream of the check valve.

(c) Submersible Pumps—Where a submersible pump is used, the top of the casing shall be effectively sealed against entrance of water under all conditions of vibration or movement of conductors or cables. For hydropneumatic systems not equipped with an air compressor, the discharge pipe shall be equipped with a snifter (a device which will allow air to enter the drop-pipe) upstream of the check valve and a bleeder valve on the drop-pipe located above the static water level in the well.

(d) Well head piping—The well head piping shall be provided with a valved means to pump waste to a point away from the groundwater source, but shall not be directly connected to a sewer. Neither the well head nor the well head piping shall be buried below grade or in a pit. The discharge line shall:

(i) Have control valves located above the pump floor;

(ii) Be protected against freezing;

(iii) Be valved to permit testing and control of each well;

(iv) Have watertight joints;

(v) Have all exposed valves protected; and,

(vi) Have erosion protection at the point of discharge from the blow-off.

(e) Water Seals—Water seals shall not be supplied with water of a lesser sanitary quality than that of the water being pumped. Where pumps are sealed with potable water and are pumping water of lesser sanitary quality the seal shall be provided with a back-flow preventer appropriate for the degree of hazard in question.

(f) Water Pre-lubrication—When automatic pre-lubrication of pump bearings is necessary and an auxiliary power supply is provided, the pre-lubrication line shall be provided with a valved bypass around the automatic control so that the bearings can, if necessary, be lubricated manually before the pump is started.

C. General Design Requirements.

(1) Plant Layout—Design shall provide for an adequate access road, site drainage, protection of well(s) from spillage, and adequate protection from vandalism. Consideration shall also be given to functional aspects of the plant layout and future expansion.

(2) Building Layout—Design shall provide, if necessary, for adequate ventilation, lighting, telephone service, heating and air conditioning, floor drainage, and dehumidification equipment. Consideration shall also be given to accessibility of equipment for operation, servicing, and removal, telephone communication capability, flexibility of operation, operator safety, and convenience of operation.

(3) Electrical Controls—Main switch gear electrical controls shall be located above grade and protected from standing water.

(4) Auxiliary Power—Where elevated storage equals less than one half maximum daily demand, portable or in-place auxiliary power shall be provided for all systems serving three hundred (300) or more service connections. An air quality permit may be required for the emissions from the auxiliary generators. Auxiliary power requirements may be waived if one or more of the following are applicable:

(a) a verifiable history of worst case power outages and verification that the available elevated storage can provide for a similar time period of outage;

(b) two (2) or more independent sources from the serving electrical utility are available; or,

(c) an alternate water source is available via connections with other systems.

Auxiliary power shall be sized to provide for sufficient pumping and treatment capacity to meet one half ($\frac{1}{2}$) of the maximum daily demand or to supplement the existing storage to meet one half ($\frac{1}{2}$) of the maximum daily demand.

(5) Sample Taps—Sample taps shall be provided so that water samples can be obtained from:

- (a) each raw water source;
- (b) appropriate locations throughout the treatment process so that the operator can maintain proper control of the treatment process;
- (c) effluent from each filter prior to any post chemical addition; and,
- (d) the entry point(s) to the distribution system.

Taps shall be consistent with sampling needs and shall not be of the petcock type. Taps used for obtaining samples for bacteriological analysis shall be of the smooth-nosed type without interior or exterior threads. Taps shall not be of the mixing type, and shall not have a screen, aerator, or other such appurtenances. All sampling taps shall be easily accessible and located at least 12 inches above the floor or ground level.

(6) Chemical injection points—All chemical injection points shall be downstream of the check valve on the wellhead piping.

(7) All chemical treatment equipment shall be enclosed and protected from the weather.

(8) Process Water—The process water service line shall be supplied from a source at a point where all chemicals have been thoroughly mixed.

(9) Piping Identification—To facilitate identification of piping where treatment occurs, all pipes shall be color coded and/or marked with the name of the liquid or gas being carried and its direction of flow.

(10) Proprietary Treatment Units/Innovative Treatment Techniques—Proprietary treatment units and alternative treatment technology may be considered if pilot tests demonstrate the ability of the technology to provide water which meets all drinking water standards utilizing the proposed groundwater source. The unit/technology will be approved only at rates consistent with R.61-58.2(D) until satisfactory operating data for at least eighteen (18) months is obtained.

(11) Manuals and Parts Lists—An operation and maintenance manual shall be provided for each installation. This manual shall include repair information, parts lists for each piece of equipment, and procedures for the start up and shut down of the facility.

(12) Safety—All design must meet applicable safety codes and minimum Occupational Safety and Health Administration (OSHA) standards.

D. Groundwater Treatment.

(1) Filtration—All filters treating groundwater under the direct influence of surface water must meet the performance standards set forth in R.61-58.10(E).

The application of any one type of filtration must be supported by water quality data. Experimental treatment studies may be required to demonstrate the applicability of the method of filtration proposed.

(a) Pressure Filters—The use of these filters may be considered for iron and manganese removal and other clarification processes.

(i) Rate of Filtration—The nominal rate shall be three (3) gallons per minute per square foot of filter area and shall not exceed five (5) gallons per minute per square foot without adequate justification.

(ii) Details of Design—The filter design shall address the following:

(A) Pressure gauges on the inlet and outlet pipes of each filter shall be provided.

(B) Provisions shall be made for filtration and backwashing of each filter individually with an arrangement of piping as simple as possible to accomplish these purposes.

(C) The backwash water collection system shall be designed to allow for adequate bed expansion without loss of media.

(D) The underdrain system shall efficiently collect the filtered water and shall distribute the backwash water uniformly at a rate not less than fifteen (15) gallons per minute per square foot of filter area.

(E) Backwash flow indicators and controls shall be located such that they are easily readable while operating the control valves.

(F) An air release valve on the highest point of each filter shall be provided.

(G) An accessible manhole to facilitate inspections and repairs (above level of media) shall be provided.

(H) A means to observe the wastewater during backwashing shall be provided.

(I) No unprotected cross connections shall exist.

(J) Filter material must be in accordance with R.61-58.3(D)(5)(a)(vi).

(K) A sufficient number of filter units so as to ensure continuity of service with one unit temporarily removed from operation. The facility shall be designed so that the design filtration rate is not exceeded during backwash operation.

(L) Filter material shall have a total depth of not less than twenty-four (24) inches and generally not more than thirty (30) inches.

(M) Only finished water from the treatment process shall be used to backwash the filter(s).

(b) Gravity Filters—Gravity filters shall be designed in accordance with applicable portions of R.61-58.3(D)(5).

(c) Diatomaceous earth filtration

(i) Conditions of use—Diatomaceous earth filters are expressly excluded from consideration for bacteria removal, color removal, or turbidity removal where either the gross quantity of turbidity is high or the turbidity exhibits poor filterability characteristics.

(ii) Pilot plant study—Installation of a diatomaceous earth filtration system shall be preceded by a pilot plant study on the water to be treated.

(A) Conditions of the study such as duration, filter rates, head loss accumulation, slurry feed rates, turbidity removal, bacteria removal, etc., shall be approved by the Department prior to the study.

(B) Satisfactory pilot plant results shall be obtained prior to preparation of final construction plans and specifications.

(C) The pilot plant study shall demonstrate the ability of the system to meet applicable drinking water standards at all times.

(iii) Types of filters—Pressure or vacuum diatomaceous earth filtration units will be considered for approval.

(iv) Treated water storage—Treated water storage capacity in excess of normal requirements shall be provided to allow operation of the filters at a uniform rate during all conditions of system demand at or below the approved filtration rate, and guarantee continuity of service during adverse raw water conditions without by-passing the system.

(v) Precoat Application—A uniform precoat of at least $\frac{1}{16}$ inch shall be applied hydraulically to each septum by introducing a slurry to the tank influent line and employing either a filter-to-waste or recirculation system.

(vi) Body feed—A body feed system to apply additional amounts of diatomaceous earth slurry during the filter run is required. Continuous mixing of the body feed slurry shall be provided.

(vii) Filtration

(A) Rate of filtration—The filtration rate shall be controlled by a positive means and shall not exceed one and a half (1.5) gallons per minute per square foot of filter.

(B) Head loss—The head loss shall not exceed thirty (30) pounds per square inch for pressure diatomaceous earth filters, or a vacuum of fifteen (15) inches of mercury for a vacuum system.

(C) Recirculation—A recirculation or holding pump shall be employed to maintain differential pressure across the filter when the unit is not in operation in order to prevent the filter cake from dropping off the filter elements. A minimum recirculation rate of one tenth (0.1) gallon per minute per square foot of filter area shall be provided.

(D) Septum or filter element—The filter elements shall be structurally capable of withstanding maximum pressure and velocity variations during filtration and backwash cycles, and shall be spaced such that no less than one (1) inch is provided between elements or between any element and a wall.

(E) Inlet design—The filter influent shall be designed to prevent scour of the diatomaceous earth from the filter element.

(viii) Backwash—A satisfactory method to thoroughly remove and dispose of spent filter cake shall be provided.

(ix) Appurtenances—The following shall be provided for every filter:

(A) sampling taps for raw and filtered water;

(B) loss of head or differential pressure gauge;

(C) rate-of-flow indicator, with totalizer;

(D) a throttling valve used to reduce rates below normal during adverse raw water conditions; and,

(E) an evaluation of the need for body feed, recirculation, and any other pumps, in accordance with R.61-58.4(B)(1)(d).

(2) Disinfection—Disinfection may be accomplished with liquid chlorine, calcium or sodium hypochlorite, chlorine dioxide, ozone or chloramines. Other agents will be considered by the Department provided that reliable feed equipment is available and test procedures for a residual are recognized, and the agent meets the requirements of an acceptable drinking water additive. Continuous disinfection will be required at groundwater supplies which are of questionable sanitary quality or where any other treatment is provided. Due consideration shall be given to the contact time of the disinfectant in water with relation to pH, ammonia, taste-producing substances, temperature, bacterial quality, and other pertinent factors. Consideration also must be given to the formation of disinfection by-products.

(a) Chlorination—Where chlorine is used the following shall apply:

(i) Type—Only vacuum type gas chlorinators or hypochlorite feeders of the positive displacement type are acceptable.

(ii) Capacity—The chlorinator capacity shall be such that a free chlorine residual of at least five (5) milligram per liter can be attained in the water after a contact time of at least thirty (30) minutes at maximum flow rates. The equipment shall be of such design that it will operate accurately over the desired feeding range.

(iii) Automatic Proportioning—Automatic proportioning chlorinators will be required where the rate of flow or chlorine demand is not reasonably constant or where the rate of flow of the water is not manually controlled.

(iv) Residual chlorine—Where alternate disinfectants are used in the treatment process, the capability for the addition of either free or combined chlorine in the finished water shall be provided.

(b) Cross connection protection—The chlorinator water supply piping shall be designed to prevent contamination of the treated water supply by sources of questionable quality.

(c) Chlorine gas - Consideration shall be given to the location of gas chlorine facilities and the safety of the public in the surrounding area. The Department reserves the right to deny approval of chlorine gas on the basis of hazards to the public health. . Consideration may be given for facilities that propose the use of chlorine gas in inhabited areas when the use of safety devices which will not allow the release of chlorine gas (e.g. chlorine scrubbers) are provided. Only vacuum gas chlorinator systems will be approved.

(i) Chlorine gas feed equipment shall be enclosed and separated from other operating areas. Concrete, wood, and other construction materials shall be sealed to prevent the escape of

chlorine gas from the chlorine building. The chlorine room shall be provided with a shatter resistant inspection window installed in an interior wall or an inspection window in the door. It shall be constructed in such a manner that all openings between the chlorine room and the remainder of the plant are sealed, and shall be provided with doors ensuring ready means of exit and opening only to the building exterior.

(ii) Full and empty cylinders of chlorine gas shall be isolated from operating areas, restrained in position to prevent upset, stored in rooms separate from ammonia storage, and stored in areas not in direct sunlight or exposed to excessive heat.

(iii) If the chlorine room is large enough for a person to enter, the room shall be constructed such that:

(A) It has a ventilating fan with a capacity which provides one complete air change per minute;

(B) The ventilating fan shall be located near the ceiling and pull suction through a duct extending to within twelve (12) inches of the floor and discharge as far as practical from the door and air inlet. The point of discharge shall be located so as not to contaminate air inlets to any rooms or structures. A sealed motor or other means shall be used to ensure the reliability of the fan;

(C) Air inlets shall be located near the ceiling;

(D) Air inlets and outlets shall have mechanical louvers;

(E) Switches for fans and lights are outside of the room, at the entrance;

(F) Vents from feeders and storage areas discharge to the outside atmosphere, above grade and away from inlet vent; and,

(G) Ventilation shall not be automatically controlled.

(iv) If the room is too small for a person to enter, the room must meet the requirements of R.61-58.2(D)(2)(c)(iii)(E) and (F).

(v) Chlorine feed lines shall meet the following requirements:

(A) Chlorine gas under pressure shall be piped with schedule eighty (80) stainless steel or schedule eighty (80) seamless carbon steel. No chlorine gas under pressure will be piped beyond the chlorinator room.

(B) Chlorine gas under vacuum shall be piped with schedule eighty (80) PVC or reinforced fiberglass.

(C) Chlorine solution shall be piped with schedule eighty (80) PVC.

(vi) Heaters shall be provided to maintain proper temperature for operation.

(vii) There shall be no equipment housed in the chlorine room except chlorinators, chlorine cylinders, weighing scales, heater, ventilation fan, and light(s).

(viii) Weighing scales shall be provided for weighing cylinders, at all installations utilizing chlorine gas unless provisions for automatic switchover of cylinders and an acceptable alternate means to determine daily dosage are provided.

(ix) Chlorine feed systems shall be designed to ensure continuous feed of chlorine.

(x) If a floor drain is provided, it shall be equipped with a water seal or trap to prevent escaped gases from exiting through the building sewer.

(xi) A chlorine leak detection and alarm system shall be provided.

(xii) An air pack approved by the National Institute for Occupational Safety and Health shall be available for each gas chlorination installation.

(xiii) A chlorine cylinder repair kit for plugging the type of chlorine cylinders used shall be available for each gas chlorination installation.

(d) Ozone—Ozone is a suitable disinfectant for groundwater. On-site generation facilities shall be constructed in accordance with manufacturer's standards.

(i) Pilot plant tests—Pilot plant tests shall be performed with the water to be treated to establish the optimum dosage, contact time, depth of conductor and the need for multiple application points.

(ii) Building Design—Ozone generators shall be housed in a separate room with separate heating and ventilation. The building layout must provide for easy access to the equipment. Ventilation equipment shall be two (2) speed with the normal speed providing the normal distribution of heat or air movement. The second speed must be capable of providing a complete turnover of the air in the room every two (2) minutes to exhaust any ozone leakage in an emergency.

(iii) Piping Materials

(A) All dry ozone gas piping shall be mechanical jointed number 304 or 316 stainless steel or welded 304L or 316L stainless steel. All wet ozone gas piping shall be number 316 or 316L stainless steel. All flexible couplings shall be stainless steel.

(B) Valves shall be stainless steel face and body.

(C) Gasket materials shall be resistant to deterioration by the ozone.

(vi) Reinforced concrete or stainless steel are acceptable materials. All concrete joints shall be sealed using a synthetic rubber material resistant to deterioration by the ozone.

(e) Other disinfection agents—Any proposal for the use of other disinfecting agents shall be approved by the Department prior to preparation of final plans and specifications.

(f) Ammonia Gas—Consideration shall be given to the location of ammonia gas facilities and the safety of the public in the surrounding area. The Department reserves the right to deny approval of ammonia gas on the basis of hazards to the public health. Only vacuum ammonia systems will be approved.

(i) Ammonia gas feed equipment shall be enclosed and separated from other operating areas. Concrete, wood, and other construction materials shall be sealed to prevent the escape of ammonia gas from the ammonia room. The ammonia room shall be provided with a shatter resistant inspection window installed in an interior wall or an inspection window in the door. It shall be constructed in such a manner that all openings between the ammonia room and the remainder of the plant are sealed, and shall be provided with doors ensuring ready means of exit and opening only to the building exterior.

(ii) Full and empty cylinders of ammonia gas shall be isolated from operating areas, restrained in position to prevent upset, stored in rooms separate from chlorine storage, and stored in areas not in direct sunlight or exposed to excessive heat.

(iii) If the ammonia room is large enough for a person to enter, the room shall be constructed such that:

(A) It has a ventilating fan with a capacity which provides one complete air change per minute;

(B) The ventilating fan shall be located and pull suction near the ceiling and discharge as far as practical from the door and air inlet. The point of discharge shall be located so as not to contaminate air inlets to any rooms or structures. A sealed motor or other means shall be used to ensure the reliability of the fan;

(C) Air inlets shall be located near the floor;

(D) Air inlets and outlets shall have mechanical louvers;

(E) Switches for fans and lights are outside of the room, at the entrance;

(F) Vents from feeders and storage areas discharge to the outside atmosphere, above grade and away from inlet vent; and,

(G) Ventilation shall not be automatically controlled.

(iv) If the room is too small for a person to enter, the room must meet the requirements of R.61-58.2(D)(2)(f)(iii)(E) and (F).

(v) Ammonia feed lines shall not carry ammonia gas beyond the ammonia room.

(vi) There shall be no equipment housed in the ammonia room except ammoniators, ammonia cylinders, weighing scales, heater, ventilation fan, and light(s).

(vii) Weighing scales shall be provided for weighing cylinders, at all installations utilizing ammonia gas from cylinders. Where bulk storage tanks are installed, they shall be equipped with a pressure gauge.

(viii) An ammonia leak detection and alarm system shall be provided.

(g) Chlorine Dioxide - Chlorine dioxide is a suitable disinfectant for groundwater. Chlorine dioxide shall be generated on site. The unit shall be flow paced and not have a holding tank for the chlorine dioxide solution generated. All applicable EPA disinfectant by-product rules shall be observed.

(i) Sizing of the chlorine dioxide generator - Chlorine dioxide demand studies shall be conducted to determine estimated feed rates and points of feed.

(ii) Building Design -

(A) Chlorine dioxide generators shall be located in a room separate from chlorine cylinders.

(B) Number of Units: Where chlorine dioxide is used as the primary disinfectant, at least two (2) flow pacing chlorine dioxide generators shall be provided. The facility shall be adequately sized to supply the maximum treatment capacity with any one generator out of service. If chlorine dioxide is not used as a primary disinfectant (i.e. an oxidant only), a second generator is not required.

(iii) Piping Materials -

(A) All piping from the chlorine dioxide generator shall be schedule 80 PVC

(B) Gasket materials shall be kynar or other compatible material.

(C) All tubing connector fittings shall be kynar or other compatible material.

(3) Softening—The softening process selected shall be based upon the mineral qualities of the raw water and the desired finished water quality in conjunction with requirements for the disposal of brine waste, the plant location. Applicability of the process chosen shall be demonstrated. Ion exchange units used for softening shall be designed in accordance with R.61-58.2.D(4).

(4) Ion Exchange Process—The total iron and manganese concentration shall not exceed three tenth (0.30) milligrams per liter in the water as applied to the ion exchange material. Pretreatment is required when the total iron and manganese concentration exceeds is three tenth (0.3) milligram per liter or more.

(a) Design—The units may be of pressure or gravity type, of either an upflow or downflow design. A manual override shall be provided on all automatic controls.

(b) Exchange Capacity—The design capacity for hardness removal shall not exceed twenty thousand (20,000) grains per cubic foot when resin is regenerated with three tenth (0.3) pounds of salt per kilograin of hardness removed.

(c) Depth of Media—Exchange resin shall have a total depth of not less than twenty-four (24) inches and generally not more than thirty (30) inches unless otherwise approved by the Department.

(d) Flow Rates—The rate of softening shall be based on an actual bench scale test of the water to be treated. The backwash rate shall be sufficient to clean the bed. The flow rate will be dependent on the grain size and specific gravity of the exchange resin.

(e) Bypass—A bypass may be provided around softening units to produce a blended water of desirable hardness. Meters shall be installed on the bypass line and on each softener unit.

(f) Additional limitations—Waters having five (5) units or more turbidity shall not be applied directly to the cation exchange softener. Silica gel resins shall not be used for waters having a pH above 8.4 and shall not be used when iron is present. When the applied water contains a chlorine residual, the cation exchange resin shall be a type that is not damaged by residual chlorine. Phenolic resin shall not be used.

(g) Sampling Taps—Smooth-nose sampling taps shall be provided for the collection of representative samples for both bacteriological and chemical analyses. The taps shall be located to allow

sampling of the softener influent, the softener effluent, and the blended water. The sampling taps for the blended water shall be at least twenty (20) feet downstream from the point of blending. Petcocks are not acceptable as sampling taps.

(h) Brine and Salt Storage Tanks—Brine measuring or salt dissolving tanks and wet salt storage facilities shall be covered and shall be constructed of corrosion-resistant material. The make-up water inlet shall have a free fall discharge of two (2) pipe diameters above the maximum liquid level of the unit, or shall be protected from back-siphonage by use of a vacuum breaker. The salt shall be supported on graduated layers of gravel under which is a suitable means of collecting the brine. Wet salt storage basins shall be equipped with manhole or hatchway openings having raised curbs and watertight covers having overhanging edges. Overflows, where provided, must be angled downward, have a proper free fall discharge and be protected with noncorrodible screens or self-closing flap valves.

(i) Storage Capacity—Wet salt storage basins shall have sufficient capacity to provide for at least three (3) days of operation.

(j) Corrosion Control—Corrosion control shall be provided.

(k) Waste Disposal—A suitable means of handling and disposal shall be provided for brine waste designed in accordance with 61-58.2(F).

(l) Construction Material—Pipes and contact materials shall be corrosion resistant.

(m) Housing—Salt storage tanks and feed equipment shall be enclosed.

(5) Aeration—Aeration treatment devices, as described herein, may be used for oxidation, separation of gases or for taste and odor control. A separate air quality permit for the separation of gases from water by aeration may be necessary.

(a) General Requirements

(i) Sample taps must be provided following aeration equipment.

(ii) Where aeration equipment discharges directly to the distribution system, air release valves must be provided.

(b) Natural Draft Aeration—Design shall provide that:

(i) Water is distributed uniformly over the top tray;

(ii) Water is discharged through a series of three (3) or more trays with the separation of trays not less than twelve (12) inches;

(iii) Trays are loaded at a rate of one (1) gallon per minute to five (5) gallons per minutes for each square foot of total tray area;

(iv) Trays have slotted, woven wire cloth or perforated bottoms;

(v) Perforation are three sixteenth ($\frac{3}{16}$) to one-half ($\frac{1}{2}$) inches in diameter, spaced one (1) to three (3) inches on centers, when perforations are used in the distribution pan;

(vi) Construction of durable material resistant to the aggressiveness of the water and dissolved gases;

(vii) Protection of aerators from loss of spray water by wind carriage by enclosure with louvers sloped to the inside at an angle of approximately forty-five (45) degrees;

(viii) Protection from insects by number twenty-four (24) mesh screen; and,

(ix) Aerated water receives disinfection treatment.

(c) Forced or Induced Draft Aeration—Devices shall be designed to:

(i) Provide an adequate countercurrent of air through the enclosed aeration column;

(ii) Include a blower in a screened enclosure and with a watertight motor;

(iii) Exhaust air directly to the outside atmosphere;

(iv) Include a down-turned, number twenty-four (24) mesh screened air outlet and inlet;

(v) Be such that air introduced in the column shall be as free from noxious fumes, dust, and dirt as possible;

- (vi) Be such that sections of the aerator can be easily reached or removed for maintenance of the interior;
 - (vii) Provide loading at a rate of one (1) to five (5) gallons per minute for each square foot of total tray area;
 - (viii) Ensure that the water outlet is adequately sealed to prevent the unwarranted loss of air;
 - (ix) Discharge through a series of five (5) or more trays, with separation of trays not less than six (6) inches;
 - (x) Provide distribution of water uniformly over the top tray; and,
 - (xi) Be of a durable corrosion resistant material.
- (d) Pressure Aeration—This method may be used for oxidation purposes if pilot plant study indicates method is applicable. It is not acceptable for removal of dissolved gases. Filters following pressure aeration shall have adequate exhaust devices for release of air. Pressure aeration devices shall be designed to give thorough mixing of compressed air with water being treated. Screened and filtered air, free of noxious fumes, dust, dirt and other contaminants shall be provided.
- (e) Other Methods of Aeration—Other methods of aeration may be used if applicable to the treatment needs. Such methods may include, but are not restricted to, spraying, diffused air, cascades, and mechanical aeration. The treatment processes shall be designed to meet the particular needs of the water to be treated and shall be subject to Department approval.
- (f) Protection from Contamination—Aerators that are used for oxidation or removal of dissolved gases from waters that will be given no further treatment other than chlorination shall be protected from contamination from insects and birds by a roof or similar structure.
- (g) Disinfection—Groundwater supplies exposed to the atmosphere by aeration must receive chlorination as a minimum additional treatment.
- (6) Iron and Manganese Control—Iron and manganese control, as used herein, refers solely to treatment processes designed specifically for this purpose.
- (a) Removal by Oxidation, Detention and Filtration.
 - (i) Oxidation—Oxidation shall be by aeration or by chemical oxidation with chlorine, potassium permanganate, chlorine dioxide, ozone or other oxidant approved by the Department.
 - (ii) A minimum detention of twenty (20) minutes shall be provided following oxidation by aeration to ensure that the oxidation reactions are as complete as possible. This minimum detention shall be omitted only where a pilot plant study or an analogous system indicates no need for detention.
 - (iii) Sedimentation basins shall be provided when treating water with high iron and/or manganese content or where chemical coagulation is used to reduce the load on the filters.
 - (A) Detention time—Sedimentation basin design considerations and calculations shall include basin overflow rate, weir loading rate, flow through velocity and theoretical detention time.
 - (B) Inlet Devices—Inlets shall be designed to distribute water equally and at uniform velocities. The structures shall be designed so as to dissipate inlet velocities and provide uniform flows across the basin.
 - (C) Outlet Devices—Outlet devices shall be designed to maintain velocities suitable for settling in the basin and to minimize short circuiting.
 - (D) Velocity—The velocity through settling basins shall not exceed five tenths (0.5) of a foot per minute. The basins shall be designed to minimize short circuiting. Baffles shall be provided, as necessary.
 - (E) Overflow—An overflow weir (or pipe) shall be installed to establish water level in the basin.
 - (F) Sludge handling—Facilities are required by the Department for the disposal of sludge and shall be designed in accordance with R.61-58.2F. Provisions shall be made for the operator to observe and sample sludge being withdrawn from the unit.

(G) Washdown Hydrants—Washdown hydrants shall be provided and shall be equipped with backflow prevention devices acceptable to the Department.

(iv) Filtration—Filters shall conform to R.61-58.2(D)(1).

(b) Removal by Manganese Green Sand Filtration

(i) An anthracite media cap of at least six (6) inches shall be provided over manganese green sand.

(ii) The filtration rate will be dependent on the raw water quality and the type of filter used. It shall not exceed three (3) gallons per minute per square foot.

(iii) The backwash rate shall be sufficient to clean the bed.

(iv) Sample taps shall be provided prior to the application of permanganate; immediately ahead of filtration; at a point between the anthracite coal media and the manganese treated greensand; halfway down the manganese treated greensand; and at the effluent for each filter.

(v) A differential pressure gauge or separate inlet and outlet pressure gauges shall be provided to measure the loss of head through the unit.

(c) Removal by Ion Exchange—Iron removal with sodium zeolite ion exchange units shall not be approved without a pilot study addressing the efficiency of removal, an evaluation of the potential for bed fouling, and consideration of the corrosiveness of the treated water. The Ion Exchange process treatment shall be designed in accordance with R.61-58.2(D)(4).

(d) Sequestration by phosphates—Where phosphate treatment is used, sufficient disinfectant residuals shall be maintained in the distribution system.

(i) Phosphates shall not be applied ahead of the filters in iron and manganese removal treatment. Where there is no removal treatment, the phosphate shall be added prior to any disinfection.

(ii) Phosphate chemicals shall meet the requirements of chemical additives in R.61-58.2(E)(3), including maximum feed rates.

(e) Sampling Taps—Smooth-nosed sampling taps shall be located on each source, each treatment unit influent and each treatment unit effluent.

(7) Fluoridation—Commercial sodium fluoride, sodium silicofluoride and hydrofluorosilic acid shall be NSF approved and shall conform to American Waterworks Association Standards B701, B702 and B703 respectively. Fluoride chemicals shall meet the requirements of chemical additives in R.61-58.2(E)(3). The proposed method of fluoride feed shall be approved by the Department prior to preparation of final plans and specifications.

(a) Fluoride Compound Storage—Dry chemical storage shall be designed in accordance with R.61-58.2(E)(2)(e). Storage units for hydrofluorosilic acid shall be isolated from operating areas and shall be vented to the atmosphere at a point outside any building.

(b) Injection Point—The fluoride compound shall not be added before ion exchange softening or before lime addition, to avoid precipitation of fluoride.

(c) Chemical Feed Installations—Fluoride feed systems shall meet the following criteria:

(i) Scales or loss-of-weight recorders for weighing the quantity of chemicals added shall be provided;

(ii) Feed equipment shall have an accuracy to within five (5) percent of any desired feed rate;

(iii) The point of application of hydrofluorosilic acid, if into a pipe, shall be in the lower half of the pipe and project upward at an angle approximately forty (40) degrees and extend into the pipe one-third of diameter; and,

(iv) All fluoride feed lines shall be provided with adequate antisiphon devices.

(v) All fluoride feed systems shall be equipped with a fail-safe system to prevent the continued feed of fluoride at times when there is no flow of water through the fluoride feed point.

(d) Protective equipment—At least one (1) pair of rubber gloves, a respirator of a type certified by the National Institute for Occupational Safety and Health for toxic dusts or acid gas (as necessary), an apron or other protective clothing, and goggles or face masks shall be provided for

use by the operator. Other protective equipment may be required, as deemed necessary by the Department.

(e) Dust Control

(i) Provisions shall be made for the transfer of dry fluoride compounds from shipping containers to storage bins or hoppers in such a way as to minimize the quantity of fluoride dust which may enter the room in which the equipment is installed. The enclosure shall be provided with an exhaust fan and dust filter to the outside atmosphere of the building.

(ii) Provisions shall be made for disposing of empty bags, drums and barrels in a manner which will minimize exposure to fluoride dusts. A floor drain shall be provided to facilitate the washing of floors.

(8) Corrosion Control—Water that is corrosive due either to natural causes or to treatment given the water shall be rendered non-corrosive, and nonaggressive before being pumped to the distribution system.

(a) Alkali Feed—Corrosive water due to natural occurrence, or chemical exchange process shall be treated by an alkali feed. Alkali feed can consist of lime, soda ash, bicarbonate, caustic soda, or a combination of any of the above. Lime feed systems shall include a mechanism for flushing the feed lines, including suction and pumping equipment, if used.

(b) Phosphates—The feeding of phosphates may be applicable for corrosion control. Phosphate chemicals shall meet the requirements of chemical additives in R.61-58.2(E)(3).

(c) Carbon dioxide addition

(i) Recarbonation basin design shall provide:

(A) A total detention time of at least twenty (20) minutes.

(B) A minimum of two (2) compartments, consisting of a mixing compartment having a detention time of at least three (3) minutes, and a reaction compartment.

(ii) Carbon dioxide feed systems shall be isolated from the operating area and adequate precautions shall be taken to prevent the possibility of carbon monoxide entering the plant from recarbonation compartments.

(iii) Provisions shall be made for draining the recarbonation basin and removing sludge.

(d) Other Treatment—Other treatment for controlling corrosive waters will be considered on a case by case basis. All chemicals must meet the requirements in R.61-58.2(E)(3). Any proprietary compound must receive the specific approval of the Department before use.

(e) Control—Laboratory equipment, acceptable to the Department, shall be provided to test the compounds being fed.

(9) Taste and Odor Control—When necessary, provision shall be made for the addition of taste and odor control chemicals. These chemicals shall be added sufficiently ahead of other treatment processes to ensure adequate contact time for an effective and economical use of the chemicals.

(a) Flexibility—Plants treating water that is known to have taste and odor problems shall be provided with equipment that makes several of the control processes available to allow the operator flexibility in operation.

(b) Chlorination—Chlorination can be used for the removal of some objectionable odors. Adequate contact time must be provided to complete the chemical reactions involved. Consideration shall be given to the formation of disinfection by-products if this method is used.

(c) Chlorine Dioxide—Chlorine dioxide may be used in the treatment of taste or odor. Provision shall be made for the proper storing and handling of sodium chlorite, so as to eliminate any danger of explosion. Consideration shall be given to the formation of disinfection by-products if this method is used.

(d) Granular Activated Carbon Absorption Units—Rates of flow shall be consistent with the type and intensity of the problem. The rate used shall be supported by the results of pilot plant studies and shall be in accordance with the requirements of R.61-58.2(D)(1).

(e) Aeration—Aeration units used for taste and odor removal shall be designed in accordance with R.61-58.2(D)(5).

(f) Potassium Permanganate—The application of potassium permanganate may be considered, provided that dosages are determined by permanganate demand testing.

(10) Membrane Technology—All applications for projects involving membrane technology must be preceded by an engineering report and may require a pilot study.

(a) Reverse Osmosis

(i) Pilot Study—The pilot study, where required, must determine or address the following items:

- (A) Membrane loading rates including the most efficient percentage of recovery;
- (B) What pre-treatment is needed including feed rates of any chemicals;
- (C) Whether by-pass blending can be used and what the blending rate will be;
- (D) The post treatment needs including what chemical additions will be necessary to make the finished water non-corrosive; and,
- (E) The best type of membrane for the source water application.

(ii) General Design Requirements—

- (A) A flow meter with totalizer must be provided for the permeate and the blend lines in each treatment train.
- (B) Valves must be provided on the influent, permeate, reject, and cleaning lines for each unit.
- (C) Pressure gauges must be provided on the influent and permeate lines for each unit for measurement of head loss.
- (D) Sample taps must be provided for the permeate, blended product, and finished water.
- (E) Monitoring equipment must be provided to measure pH, conductivity, temperature, turbidity, and any specific contaminants for which treatment is being provided.
- (F) Disposal of concentrate and cleaning solutions must be approved by the Department.

(iii) Reverse Osmosis Membrane Material -

(A) Membrane material used in public water systems shall be certified as meeting the specification of the American National Standards Institute/National Sanitation Foundation Standard 61, Drinking Water System Components - Health Effects. The certifying party shall be accredited by the American National Standards Institute.

(B) Loading rates must be determined by pilot testing and manufacturers recommendations.

(iv) Scale Inhibitors and Cleaning Solutions—Scale inhibitors and cleaning solutions must meet the requirements of chemical additives in R.61-58.2(E)(3).

(v) Post-Treatment—

- (A) Continuous disinfection must be employed on the permeate or on the blended effluent from the treatment units.
- (B) Treatment shall be employed to render the finished water non-corrosive.

(b) Electrodialysis Reversal—Electrodialysis reversal treatment shall not be used on surface water or groundwater under the direct influence of surface water unless the requirements of R.61-58.10 are otherwise met.

(i) Pretreatment—Pretreatment must be used to protect the membrane from fouling. Media filtration used in pretreatment must be designed in accordance with R.61-58.2(D)(1). Degassification must be designed in accordance with R.61-58.2(D)(5).

(ii) Pilot Study—The pilot study must determine or address the following items:

- (A) Membrane loading rates including the most efficient percentage of recovery;
- (B) What pre-treatment is needed including feed rates of any chemicals;
- (C) Whether by-pass blending can be used and what the blending rate will be;

(D) The post treatment needs, including what chemical additions will be necessary to make the finished water non-corrosive; and,

(E) The best type of membrane for the source water application.

(iii) General Design Requirements—

(A) A gallon meter with totalizer must be provided for the product water and the blend lines in each treatment train.

(B) Valves must be provided on the influent, product water, reject, and cleaning lines for each unit.

(C) Electric volt and current meters must be provided to measure the electric potential across each unit.

(D) Pressure gauges must be provided on the influent and product lines for each unit for measurement of head loss.

(E) Sample taps must be provided for the product, blended water, and finished water.

(F) Monitoring equipment must be provided to measure pH, conductivity, temperature, turbidity, and any specific contaminants for which treatment is being provided.

(G) Disposal of concentrate and cleaning solutions must be approved by the Department.

(iv) Electrodialysis Reversal Membrane Material -

(A) Membrane material used in public water systems shall be certified as meeting the specification of the American National Standard Institute/National Sanitation Foundation Standard 61, Drinking Water System Components - Health Effects. The certifying party shall be accredited by the American National Standards Institute.

(B) Loading rates must be determined by pilot testing and manufacturers recommendations.

(v) Scale Inhibitors and Cleaning Solutions—Scale inhibitors and cleaning solutions must meet the requirements of chemical additives in R.61-58.2(E)(3).

(vi) Post-Treatment—

(A) Continuous disinfection must be employed on the product water or on the blended effluent from the treatment units.

(B) Treatment shall be employed to render the finished water non-corrosive.

E. Chemical Application.

(1) General—No chemical shall be applied to treat drinking waters unless specifically permitted by the Department. A certified operator is required whenever the chemical or physical characteristics of the water is changed.

(a) Plans and specifications—Plans and Specifications shall be submitted for review and approval, as required by in R.61-58.1, and shall include:

(i) Descriptions of feed equipment, including maximum and minimum feed ranges and pump curves for solution feeders,

(ii) Location of feeders, piping layout and points of chemical application,

(iii) Storage and handling facilities;

(iv) Specifications for chemicals to be used;

(v) Operating and control procedures including proposed application rates;

(vi) Descriptions of testing equipment and procedures; and,

(vii) Locations of sampling taps for testing.

(b) Chemical application—Chemicals shall be applied to the water at such points and by such means as to:

(i) Provide maximum efficiency of treatment;

(ii) Ensure maximum safety to consumer;

(iii) Provide maximum safety to operators;

- (iv) Ensure satisfactory mixing of the chemicals with the water;
 - (v) Provide maximum flexibility of operation through various points of application, when appropriate;
 - (vi) Prevent backflow or back-siphonage between multiple points of feed through the use of separate feed equipment for each point and backflow preventers where a manifold system is used for standby, multiple feed use;
 - (vii) Not be located upstream of the metering device when the chemical in consideration will interfere with the flow measurement;
 - (viii) Provide a separate injection point and a separate feed line for each chemical application that is added and, spacing to prevent inter-reaction of chemicals; and,
 - (ix) Provide chemical injection points which are readily accessible. All below-grade injection points shall be housed in a vault or similar structure.
- (c) General equipment design—General equipment design shall be such that:
- (i) Chemical-contact materials and surfaces are corrosion resistant;
 - (ii) Corrosive chemicals are introduced in such a manner as to minimize potential for corrosion; and,
 - (iii) Chemicals that are incompatible are not fed, stored or handled together.

(2) Facility Design

- (a) Chemical feeders—
- (i) A separate feeder shall be used for each separate chemical applied, and for each injection point.
 - (ii) Spare parts shall be available for all feeders to replace parts which are subject to wear and damage.
 - (iii) Dry chemical feeders shall:
 - (A) Measure chemicals volumetrically or gravimetrically;
 - (B) Provide adequate solution water and agitation of the chemical in the solution pot;
 - (C) Provide gravity feed from solution pots; and,
 - (D) Completely enclose chemicals to prevent emission of dust to the operating room.
 - (iv) Chemical feed equipment, where necessary, shall be located in a separate room to reduce hazards and dust problems; shall be conveniently located near points of application to minimize length of feed lines; and, shall be readily accessible for servicing, repair, and observation of operation.
 - (v) Feeders shall be able to supply, at all times, the necessary amounts of chemicals at an accurate rate;
- (b) Control—
- (i) Feeders with automatic controls shall be designed so as to allow override by manual controls.
 - (ii) Chemical feed rates shall be proportional to flow.
 - (iii) Meters, scales, calibration columns, or other acceptable means to measure chemicals being fed must be provided in order to determine chemical feed rates.
 - (iv) Provisions shall be made for measuring the quantities of chemicals used.
- (c) Cross-connection control—
- (i) Cross-connection control shall be provided to ensure that liquid chemical solutions cannot be siphoned through solution feeders into the water supply.
 - (ii) The service water lines discharging to the solution tanks shall be properly protected from backflow as required by the Department.
 - (iii) No direct connection shall exist between any sewer and a drain or overflow from the feeder, solution chamber or tank. All drains shall terminate at least six (6) inches or two (2) pipe

diameters, whichever is greater, above the overflow rim of a receiving sump, conduit or waste receptacle.

(d) Service water supply shall be ample in supply and adequate in pressure; shall be provided with means for measurement when preparing specific solution concentrations by dilution; shall be properly treated potable water; and shall be properly protected against backflow.

(e) Storage of chemicals—

(i) Space shall be provided for at least three (3) days of chemical supply and provide for convenient, efficient and safe handling of chemicals. Dry storage conditions must be maintained for dry chemicals.

(ii) Storage tanks and pipelines for liquid chemicals shall be designed specifically for each chemical used.

(iii) Chemicals shall be stored in covered or unopened shipping containers, unless the chemical is transferred into an approved covered storage unit.

(f) Solution tanks—

(i) A means which is consistent with the nature of the chemical solution shall be provided in a solution tank to maintain a uniform strength of solution. Continuous agitation shall be provided to maintain slurries in suspension.

(ii) Means shall be provided to measure the solution level in the tank.

(iii) Chemical solutions shall be kept covered. Large tanks with access openings shall have such openings curbed and fitted with tight overhanging covers.

(iv) Overflow pipes, when provided, shall:

(A) Be turned downward, with the end screened;

(B) Have an air gap of two (2) pipe diameters or six (6) inches, whichever is greater; and,

(C) Be located where noticeable.

(v) Acid storage tanks shall be vented independently to the outside atmosphere.

(vi) Each tank shall be provided with a valved drain, protected against backflow in accordance with R.61-58.2(E)(2)(c)(iii).

(g) Feed lines—

(i) Feed lines shall be as short as possible in length of run, and of durable, corrosion resistant material. They shall be easily accessible throughout the entire length, protected against freezing, and readily cleanable;

(ii) Feed lines shall be designed consistent with scale-forming or solids depositing properties of the water, chemical, solution or mixture conveyed;

(iii) Feed lines shall be color coded and labeled; and,

(iv) Where lime is added, a spare feed line equal in length to the longest run of feed line, shall be provided.

(h) Handling—

(i) Provisions shall be made for disposing of empty bags, drums or barrels by an approved procedure which will minimize exposure to dust.

(ii) Provision shall be made for the proper transfer of dry chemicals from shipping containers to storage bins or hoppers, in such a way as to minimize the quantity of dust which may enter the room in which the equipment is installed.

(iii) Provision shall be made for measuring quantities of chemicals used to prepare feed solutions.

(i) Housing—

(i) Floor surfaces shall be smooth, impervious, slip-proof and well-drained.

(ii) Vents from feeders, storage facilities and equipment exhaust shall discharge to the outside atmosphere above grade and remote from air intakes.

(iii) Feeders used in conjunction with dry lime or carbon shall be housed in separate, individual rooms equipped with dust control systems.

(iv) Sufficient lighting for operator safety and sufficient heating to provide for proper operation of the chemical feed equipment shall be provided for all chemical feed rooms.

(3) Chemicals Specifications—All chemicals and products added to a public water supply as part of the treatment process shall be certified as meeting the specifications of the American National Standards Institute/National Sanitation Foundation Standard 60, Drinking Water Treatment Chemicals—Health Effects. The certifying party shall be accredited by the American National Standards Institute.

F. Waste Handling and Disposal.

Waste handling and disposal practices shall meet all applicable rules and regulations of the Department. Provisions must be made for proper disposal of treatment waste such as iron sludge, filter backwash water, and brine waste. In locating waste disposal facilities, due consideration shall be given to preventing potential contamination of the water supply. For projects involving a surface water discharge of treatment residuals, a National Pollutant Discharge Elimination System (NPDES) permit must be obtained from the Department. For projects involving land application of treatment residuals, a No Discharge (ND) permit must be obtained from the Department.

HISTORY: Amended by State Register Volume 19, Issue No. 7, eff July 28, 1995; State Register Volume 26, Issue No. 5, Part 1, eff May 24, 2002.

61–58.3. Surface Water Sources and Treatment.

Table of Contents

- A. Applicability
- B. Surface Water Development
- C. General Design Requirements
- D. Surface Water Treatment
- E. Chemical Application
- F. Waste Handling and Disposal

A. Applicability.

This regulation applies to all new construction and all expansions or modifications of existing public water systems. If the Department can reasonably demonstrate that safe delivery of potable water to the public is jeopardized, a system may have to upgrade its existing facilities in order for an expansion or modification to meet the requirements of this regulation. This regulation prescribes minimum design standards for the construction of surface water intakes and treatment plants.

B. Surface Water Development.

(1) Quantity—Where the proposed source is to be the only source of water for the system, the quantity of water at the source shall:

(a) be adequate to meet the projected maximum daily water demand of the service area. For streams, the calculations shall be based on the lowest mean daily flow for the drought of record. For withdrawals from reservoirs, the calculation shall be based on the drought of record and shall also include requirements for other water uses in the reservoir and downstream;

(b) provide a reasonable surplus for twenty (20) years of anticipated growth;

(c) be adequate to compensate for all losses such as silting, evaporation, seepage, etc. and;

(2) Quality—An engineering evaluation shall be made considering all factors, both natural and man made, which will affect the quality of the source water. The evaluation shall include, but not be limited to:

(a) determining possible future uses of impoundments or reservoirs;

(b) determining degree of control of watershed by owner;

(c) assessing degree of hazard to the source from the accidental spillage of materials that may be toxic, harmful or detrimental to treatment processes;

(d) obtaining samples over a sufficient period of time to assess the microbiological, physical, chemical and radiological characteristics of the water;

(e) assessing the capability of the proposed treatment process to comply with the drinking water standards set forth in the Act and under R.61-58.5, R.61-58.10, and R.61-58.13.

(3) Intake Structures—The design of intake structures shall provide for:

(a) withdrawal of water from more than one level if quality varies with depth;

(b) separate facilities for release of less desirable water held in storage;

(c) capability for the cleaning of the inlet line;

(d) adequate protection against rupture by dragging anchors, etc.;

(e) inlet ports located above the bottom of the stream, lake or impoundment, but at sufficient depth to be kept submerged at low water levels;

(f) where shore wells are not provided, a diversion device capable of keeping large quantities of fish or debris from entering an intake structure;

(g) screens or gratings over the inlet to protect the pumps;

(h) a means for periodic cleaning of the screens or gratings;

(i) shore wells where necessary, which shall:

(i) have motors and electrical controls located above grade, and protected from flooding;

(ii) be accessible;

(iii) be designed against flotation;

(iv) be equipped with removable or traveling screens before the pump suction well;

(v) provide for introduction of chlorine or other chemicals in the raw water transmission main if necessary for quality control;

(vi) have intake valves and provisions for backflushing or cleaning by a mechanical device and testing for leaks, where practical; and,

(vii) have provisions for withstanding surges where necessary.

(4) Off-Stream Storage

(a) Reservoirs shall be constructed to ensure that water quality is protected by controlling runoff into the reservoir.

(b) Dikes must be structurally sound, constructed of low permeability material and protected against wind action and erosion. Vegetation and other unsuitable materials shall be removed from the dikes. Minimum dike width shall be eight (8) feet at the crest.

(c) The point of influent flow must be separated from the point of withdrawal to ensure turnover.

(5) Impoundments and Reservoirs—Unless specifically approved by the Department, the design of impoundments and reservoirs shall provide for:

(a) removal of brush, trees, and stumps to high water elevation;

(b) proper erosion control measures during construction; and,

(c) abandonment of all wells which will be inundated, in accordance with R.61-58.2(B)(15).

(6) Raw Water Pumping Facilities

(a) The facility shall be elevated to a minimum of one (1) foot above the one hundred (100) year flood elevation, or protected to such elevation, shall be readily accessible at all times unless permitted to be out of service for the period of inaccessibility, shall be graded around the station so as to lead surface drainage away from the station, and shall be protected to prevent vandalism and entrance by animals and unauthorized persons.

(b) The facility shall have adequate space for the installation of additional units if needed, and for the safe servicing of all equipment. The facility shall also be of durable construction, fire and weather resistant and with outward-opening doors.

(c) Pumping Equipment—

(i) At least two (2) pumping units shall be provided. The pumping facility shall be sized adequately to supply the full plant capacity with any pump out of service. The pumping units shall:

(A) Be driven by a prime mover able to operate against the maximum head and air temperature which may be encountered;

(B) Have spare parts and tools readily available, and,

(C) Be equipped with elapsed time hour meters for each pump or another acceptable mechanism to monitor run times.

(D) Be sized to operate from minimum to maximum pumping conditions without overloading the motor.

(ii) Suction lift shall be within allowable limits, preferably less than fifteen (15) feet and should be avoided if possible. If suction lift is necessary, provision shall be made for priming the pumps.

(iii) Prime water must not be of lesser sanitary quality than that of the water being pumped. Means shall be provided to prevent back-siphonage. When an air-operated ejector is used, the screened intake shall draw clean air from a point at least ten (10) feet above the ground or other source of possible contamination, unless the air is filtered by an apparatus approved by the Department. Vacuum priming may be used.

(iv) For pumps designed so that bearing lubrication fluids come into contact with the water being pumped, only water lubricated pumps may be used unless otherwise approved by the Department.

(d) Equipment Servicing—Pump facilities shall be designed so that proper maintenance of the equipment can be provided.

(e) Operator Access—Pump facilities shall be designed for easy access by stairs or ladders when necessary.

(f) Heating—In pump houses not occupied by personnel, only enough heat need be provided to prevent freezing of equipment or treatment process.

(g) Ventilation—Ventilation shall conform to existing local, federal, and/or state codes. Adequate ventilation shall be provided for all pumping stations.

(h) Lighting—The facility shall be adequately lighted throughout. All electrical work shall conform to the requirements of the National Electric Code or applicable state and local codes.

(i) Water Seals—Water seals shall not be supplied with water of a lesser sanitary quality than that of the water being pumped. Where pumps are sealed with potable water and are pumping water of lesser sanitary quality the seal shall be provided with a break tank or back-flow preventer. If a break tank is used, it shall be open to atmospheric pressure, have an air gap of at least six (6) inches or two (2) pipe diameters, whichever is greater, and be installed between the feeder line and the spill line of the tank. Where a back-flow preventer is used, it shall be a reduced pressure principle back-flow type installed in the feed line.

(j) Controls—Pumps, their prime movers and accessories, shall be controlled in such a manner that they will operate at rated capacity without dangerous overload. Where two or more pumps are installed, provision shall be made for alternation. Provision shall be made to prevent energizing the motor in the event of a backspin cycle. Electrical controls shall be located above grade.

(k) Water Pre-lubrication—When automatic pre-lubrication of pump bearings is necessary and an auxiliary power supply is provided, the pre-lubrication line shall be provided with a valved bypass around the automatic control so that the bearings can, if necessary, be lubricated manually before the pump is started.

C. General Design Requirements.

(1) Plant Layout—Design shall provide for adequate access roads, site drainage, protection of basins from spillage (including during delivery of chemical shipments), and adequate protection from vandalism. Consideration shall also be given to functional aspects of the plant layout and future expansion.

(2) Building layout—Design shall provide for adequate ventilation, lighting, telephone service, heating and air conditioning, floor drainage, and, if necessary, dehumidification equipment. Consideration shall also be given to accessibility of equipment for operation, servicing, and removal, telephone communication capability, flexibility of operation, operator safety, and convenience of operation (filters, basins, etc. visible to the operator).

(3) Electrical controls—Main switch gear electrical controls shall be located above grade and be protected from standing water.

(4) Auxiliary Power—Where elevated storage equals less than one half maximum daily demand, portable or in-place auxiliary power shall be provided for all systems serving three hundred (300) or more service connections. An air quality permit may be required for the emissions from the auxiliary generators. Auxiliary power requirements may be waived if one or more of the following are applicable:

- (a) A verifiable history of worst case power outages and verification that the available elevated storage can provide for a similar time period of outage.
- (b) Two (2) or more independent sources from the serving electrical utility are available. or,
- (c) An alternate water source is available via connections with other systems.

Auxiliary power shall be sized to provide for sufficient pumping and treatment capacity to meet one half ($\frac{1}{2}$) of the maximum daily demand or to supplement the existing storage to meet one half ($\frac{1}{2}$) of the maximum daily demand.

(5) Sample taps—Sample taps shall be provided so that representative water samples can be obtained from:

- (a) each raw water source;
- (b) appropriate locations throughout the treatment process so that the operator can maintain proper control of the treatment process;
- (c) effluent from each filter and the combined filter effluent prior to any post chemical addition; and,
- (d) the entry point(s) to the distribution system.

Taps shall be consistent with sampling needs and shall not be of the petcock type. Taps used for obtaining samples for bacteriological analysis shall be of the smooth-nosed type without interior or exterior threads. Taps shall not be of the mixing type, and shall not have a screen, aerator, or other such appurtenances.

(6) Monitoring Equipment

(a) Complete bacteriological and wet chemistry testing equipment is required for all surface water plants for daily monitoring of raw, coagulated, settled, filtered and finished water quality.

(b) Laboratory equipment and facilities shall be compatible with the raw water source, the intended use of the treatment plant and the complexity of the treatment process involved. Plants treating surface water shall have as a minimum the capability to monitor turbidity, appropriate disinfectant residual, pH, temperature, alkalinity, calcium hardness, and if added, fluoride, total phosphate or orthophosphate and silica.

(7) Plant Water—The treatment plant water service line and the plant finished water sample tap shall be supplied from a source of finished water at a point where all chemicals have been thoroughly mixed.

(8) Wall Castings—Consideration shall be given to providing extra wall castings built into the structure to facilitate future uses whenever pipes pass through walls of concrete structures.

(9) Flow Meters—Flow meters shall be provided for measuring raw and finished water, all backwash water, and where deemed necessary, other internal water uses at all surface water plants. Meters shall measure an instantaneous flow and have the capability to measure totalized flow.

(10) Piping Identification—To facilitate identification of piping in treatment plants and pumping stations, all pipes shall be color coded and marked with the name of the liquid or gas being carried and its direction of flow.

(11) Proprietary Treatment Units/ Innovative Treatment Techniques—Proprietary treatment units and alternative treatment technology may be considered if pilot tests demonstrate the ability of the technology to provide water which meets all drinking water standards utilizing the proposed raw water source. If the plant is permitted at rates which exceed the unit process rates specified in R.61-58.3(D), the system shall submit operating data within eighteen (18) months which justify continued operation at the higher rates. From the review of these data, the Department may revise the permitted treatment rate.

(12) Manuals and Parts Lists—An operation and maintenance manual shall be provided for each treatment plant. This manual shall, at a minimum, include repair information, parts lists for each piece of equipment, and procedures for the start up and shut down of the plant including all necessary chemical treatment systems.

(13) Safety—All design must meet applicable safety codes and minimum Occupational Safety and Health Administration (OSHA) standards.

D. Surface Water Treatment.

(1) Presedimentation—Presedimentation basins, where used, shall be designed such that:

- (a) incoming water is dispersed across the full width of the line of travel;
- (b) short circuiting shall be prevented; and,
- (c) provisions for bypassing presedimentation basins are included.

(2) Conventional Sedimentation

(a) Rapid Mix—The rapid mix shall be designed so as to ensure the rapid dispersion of chemicals throughout the water to be treated.

(i) Mechanical Mixer—The mechanical mixer shall have sufficient horsepower to provide adequate dispersion of treatment chemicals and be equipped with variable speed drive.

(ii) Location—The rapid mix and flocculation basins shall be as close together as possible.

(iii) In-line mixers must be specifically approved by the Department, and shall be designed based on manufacturers recommendation and studies using the raw water source. In-line mixers shall be accessible without excavation.

(iv) A by-pass around the rapid mix or in-line mixers is prohibited.

(b) Flocculation—A minimum of two (2) parallel flocculation basins are required.

(i) Conventional Basin Design—Inlet and outlet design shall prevent short circuiting and destruction of floc. A drain or pumps shall be provided to handle de-watering and sludge removal.

(ii) Detention—The flow through velocity shall not be less than five tenths (0.5) nor greater than one and one half (1.5) feet per minute with detention time for floc formation of at least thirty (30) minutes.

(iii) Equipment—Multi-stage agitators shall be provided. The velocity gradient (G) shall decrease with each stage. G values shall be in the range of five (5) to one hundred (100) second² - 1.

(iv) Piping—Flocculation and sedimentation basins shall be as close together as possible. The velocity of flocculated water through pipes and conduits to settling basins shall not be less than five tenths (0.5) nor greater than one and one half (1.5) feet per second. Allowances shall be made to minimize turbulence at bends and changes in direction

(v) Other designs—Baffling may be used to provide flocculation in small plants only after consultation with the Department. The design shall be such that the velocities and flows noted above will be maintained.

(c) Sedimentation—A minimum of two (2) sedimentation basins are required.

(i) Detention time - Sedimentation basin design considerations and calculations shall include basin overflow rate, weir loading rate, flow through velocity and theoretical detention time. For

conventional sedimentation basins with detention times of less than four (4) hours, an acceptable alternate basis for design must be provided and must be approved by the Department.

(ii) Inlet Devices—Inlets shall be designed to distribute water equally and at uniform velocities. The structures shall be designed so as to dissipate inlet velocities and provide uniform flows across the basin.

(iii) Outlet Devices—Outlet devices shall be designed to maintain velocities suitable for settling in the basin and to minimize short circuiting.

(iv) Outlet Flow Rate—The approach velocity at the outlet weir shall be such that the resuspension of floc is minimized.

(v) Velocity—The velocity through settling basins shall not exceed five tenths (0.5) of a foot per minute, except as specifically approved by the Department. The basins shall be designed to minimize short circuiting. Baffles shall be provided, as necessary.

(vi) Overflow—An overflow weir (or pipe) shall be installed which will establish the maximum water level desired on top of the filters. It shall overflow at a location observable to the operator.

(vii) Drainage—Basins shall be provided with the means for draining, either by gravity or pumps. The amount of time required to drain the basin shall not be such that it interferes with plant operation.

(viii) Sludge handling—Facilities are required by the Department for the disposal of sludge and shall be designed in accordance with R.61-58.3(F). Provisions shall be made for the operator to observe and sample sludge being withdrawn from the basin.

(ix) Washdown Hydrants—Washdown hydrants shall be provided and shall be equipped with backflow prevention devices acceptable to the Department.

(3) Solids Contact Clarification—A minimum of two (2) solids contact units are required unless continuous sludge withdrawal is provided.

(a) Chemical Feed—Chemicals shall be applied at such points and by such means as to ensure satisfactory mixing of the chemicals with the water.

(b) Mixing—Rapid mix device or chamber ahead of the solids contact unit may be required by the Department to assure proper mixing of the chemicals applied. Mixing devices employed shall be so constructed as to provide adequate mixing of the raw water with previously formed sludge particles, and prevent deposition of solids in the mixing zone.

(c) Flocculation—Flocculation Equipment shall:

(i) have variable speed drive;

(ii) provide for coagulation to occur in a separate chamber or baffled zone within the unit; and,

(iii) provide the flocculation and mixing period to be not less than thirty (30) minutes, except as approved by the Department.

(d) Sludge removal—Sludge removal design shall provide that:

(i) sludge pipes shall not be less than three (3) inches in diameter and shall be arranged so as to facilitate cleaning;

(ii) entrance to sludge withdrawal piping shall be designed to prevent clogging;

(iii) valves shall be located outside the tank for accessibility;

(iv) the operator may observe and sample sludge being withdrawn from the unit; and,

(v) blowdown processes are automated.

(e) Sludge handling—Facilities are required by the Department for the disposal of sludge and shall be designed in accordance with R.61-58.3(F).

(f) Cross-connections

(i) Blow off outlets and drains shall terminate with proper air gap discharge at a location satisfactory to the Department.

(ii) Cross-connection control shall be included for the potable water lines used to backflush sludge lines.

(g) Detention time—The detention time shall be established on the basis of raw water characteristics and other local conditions that affect the operation of the unit.

Design considerations and calculations shall include theoretical detention time, weir loading rate, and surface loading rate.

(h) Weirs or orifices—The units shall be equipped with either overflow weirs or orifices.

(i) Weirs shall be adjustable, and at least equivalent in length to the perimeter of the tank. They shall be constructed so that water at the surface does not travel over ten (10) feet horizontally to the collection trough.

(ii) Weir loading shall not exceed fifteen (15) gallons per minute per foot of weir length for units used for softeners or clarifiers removing heavy alum floc (high turbidity raw water), or ten (10) gallons per minute per foot of weir length for units used for clarifiers removing light alum floc (low turbidity raw water).

(iii) Weirs or orifices shall produce uniform rising rates over the entire area of the tank.

(iv) Where orifices are used, the loading per foot shall be equivalent to specified weir loadings.

(i) Overflow rates—Unless supporting data is submitted to the Department the following rates shall not be exceeded:

(i) One and seventy-five hundredths (1.75) gallons per minute per square foot of area at the slurry separation line, for units used for softeners; and,

(ii) One (1.0) gallon per minute per square foot of area at the sludge separation line for units used for turbidity removal.

(4) Tube or Plate Settlers—Pilot test data is required prior to approval of settler units. The pilot tests must demonstrate that the unit is capable of treating the source water to comply with all drinking water standards during the worst conditions of raw water quality.

(a) Inlet and outlet considerations—Inlet and outlet devices shall be designed such that proper settling velocities are maintained and short circuiting is minimized.

(b) Drainage—Drain piping from the settler units shall be sized to facilitate a quick flush of the settler units, and to prevent flooding of the other portions of the plant.

(c) Application rate for tubes - A maximum rate of two (2) gallons per minute per square foot of cross-sectional area is allowed for tube settlers, unless pilot or full scale demonstration testing indicate that higher rates do not adversely affect water quality.

(d) Application rates for plates - A maximum plate loading rate of five tenths (0.5) gallons per minute per square foot, based on eighty (80) percent of the projected horizontal plate area is allowed, unless pilot or full scale demonstration testing indicate that higher rates do not adversely affect water quality.

(e) Flushing lines - Flushing lines shall be provided to facilitate maintenance, and shall be properly protected against backflow and back siphonage.

(5) Filtration—The following criteria applies to both conventional down-flow filters and to up-flow filters. All filters treating surface water must meet the performance standards set forth in R.61-58.10(E).

The application of any one type of filtration must be supported by water quality data representing a reasonable period of time to characterize the variations in water quality. Experimental treatment studies may be required to demonstrate the applicability of the method of filtration proposed. The maximum loss of head should be designed to occur at the point of terminal filter turbidity increase.

(a) Rapid Rate Gravity Filters

(i) Pretreatment—The use of rapid rate gravity filters shall require pretreatment.

(ii) Number—At least two (2) units shall be provided. Provisions shall be made to assure continuity of service with a filter unit temporarily removed from operation. The plant shall be designed so that the design filtration rate is not exceeded during backwash operations. In addition, provisions shall be made so that hydraulic surges through the filters are minimized during flow rate changes and when filters are removed from service for backwashing.

(iii) Rate of Filtration—The rate of filtration shall be determined through considerations of such factors as the quality of the raw water, the degree of pretreatment provided, the filter media provided and other considerations required by the Department. The nominal rate shall be four (4) gallons per minute per square foot of filter area except as higher rates are justified by the professional engineer to the satisfaction of the Department.

(iv) Structural Details and hydraulics—The filter structure shall be designed to provide:

(A) vertical walls within the filter;

(B) no protrusion of the filter walls into the filter media;

(C) head room to permit normal inspection and operation;

(D) access to at least fifty (50) percent of the perimeter.

(E) minimum depth of filter of eight and one half (8- ½) feet measured from the top of the underdrain to the top of the filter bay;

(F) If a filter is designed to operate to a specified loss of head then the filter shall be designed with that water level or greater above the surface of the filter media;

(G) trapped effluent to prevent backflow of air to the bottom of the filters;

(H) prevention of floor drainage to the filter with a minimum four (4) inch curb around the filters;

(I) maximum influent velocity of treated water in pipes and conduits to filters of two (2) feet per second;

(J) cleanouts and straight alignment for influent pipes or conduits where solids loading is heavy, or following lime-soda softening;

(K) washwater drain capacity to carry maximum backwash flow;

(L) walkways around filters, to be not less than twenty-four (24) inches wide;

(M) safety handrails or walls around filter areas adjacent to walkways; and,

(N) no roof drainage into the filter or basins and conduits preceding the filters.

(v) Washwater Troughs—Washwater troughs shall be designed to provide:

(A) the bottom elevation of the trough must be above the maximum level of expanded media during washing;

(B) a two (2) inch freeboard at the maximum rate of wash;

(C) the top or edge to be level;

(D) spacing so that each trough serves the same number of square feet of filter area; and,

(E) maximum horizontal travel of suspended particles to reach trough not to exceed three (3) feet.

(vi) Filter Material—One or more of the following filter media shall be used and shall have a depth of at least thirty (30) inches.

(A) Anthracite— Clean crushed anthracite, or a combination of anthracite and other media may be considered. If used alone, the anthracite shall have an effective size of 0.45 millimeters to 0.7 millimeters and a uniformity coefficient of not less than 1.3 nor greater than 1.65. If used in conjunction with sand or other media, the anthracite shall have an effective size of 0.45 millimeters to 1.2 millimeters and a uniformity coefficient of not less than 1.3 nor greater than 1.85.

(B) Sand Media—Sand media shall have an effective size of 0.45 millimeters to 0.55 millimeters, and a uniformity coefficient of not less than 1.3 nor greater than 1.65.

(C) Granular Activated Carbon—Use of granular activated carbon media, if used alone, may be considered only with approval of the Department, and must meet the requirements for anthracite media. There shall be provision for a free chlorine residual in the water following the filters and prior to distribution. There must be a means for periodic treatment of filter material for control of bacteria and other growths, and there must be provisions for testing, regeneration, and periodic replacement of the carbon.

(D) Torpedo Sand—A three (3) inch layer of torpedo sand shall be used as a supporting media for the filter sand. Such torpedo sand shall have an effective size of 0.8 millimeters to 2.0 millimeters, and a uniformity coefficient not less than 1.3 nor greater than 1.7 millimeters.

(E) Gravel—Gravel, when used as the supporting media, shall consist of hard, rounded particles and shall not include flat or elongated particles. The coarsest gravel shall be 2.5 inches in size when the gravel rests directly on the strainer system, and shall extend above the top of the perforated laterals or strainer nozzles. The size and depth of gravel required is dependent upon the type of underdrain used. Size and depth of gravel required when using proprietary filter bottoms shall be in accordance with the manufactures recommendations.

(F) Other Filter Media Design—Other filter media design will be considered based on pilot test data and operating experience.

(vii) Filter Bottoms and Strainer Systems

(A) All filter bottom and strainer systems shall be designed to ensure both an even distribution of washwater with minimum head loss and a uniform rate of filtration.

(B) The design of manifold type collection systems shall be to provide the ratio of the area of the final openings of the strainer system to the area of the filter of 0.003; provide the total cross-sectional area of the laterals of twice the total area of the final openings; and provide the cross-sectional area of the manifold at one and one half (1.5) to two (2) times the total area of the laterals.

(C) Proprietary bottoms shall be permanently grouted or fastened in place.

(D) Porous plate bottoms shall not be used where iron or manganese may clog them or with waters treated with lime prior to filtration.

(viii) Surface Wash or Subsurface Wash—Surface wash or subsurface wash facilities shall be required for all filters treating surface water, unless an air scouring system is provided, and may be accomplished by a system of fixed nozzles or a revolving type apparatus. All surface wash or subsurface wash devices shall be designed with:

(A) provisions for water pressures of at least forty-five (45) pounds per square inch;

(B) a properly installed vacuum breaker or other approved device to prevent back siphonage; and,

(C) a rate of flow of two (2) gallons per minute per square foot of filter area with fixed nozzles or one half (0.5) gallons per minute per square foot with revolving arms.

(ix) Air Scouring—Air scouring may be used in lieu of or in conjunction with surface or subsurface wash, and is recommended for filtration rates greater than four (4) gallons per minute per square foot. The air scouring system shall be designed such that:

(A) air flow shall be three (3) to five (5) standard cubic feet per minute per square foot of filter area when the air is introduced in the underdrain; a lower rate must be used when the air scour distribution system is placed above the underdrain;

(B) excessive loss of filter media during backwashing is avoided;

(C) it is followed by a fluidization wash which is sufficient to restatify the media;

(D) the air supply remains free from contamination;

(E) clogging of the air scour nozzles and the entering of the media into the air scour distribution system is avoided;

(F) air delivery piping does not pass down through the filter media; and,

(G) regular maintenance and/or replacement of the air delivery piping may be performed.

(x) Appurtenances—Each filter shall have:

(A) sampling taps for filtered water, backwash water and rewash water;

(B) an indicating loss of head gauge;

(C) indicating flow rate control. Equipment that simply maintains a constant water level on the filters is not acceptable, unless the rate of flow onto the filter is properly controlled;

(D) provisions for filtering water to waste with a properly installed vacuum breaker or other approved device for backflow prevention;

(E) continuous recording device or computer data for loss of head and rate of flow instrumentation; and,

(F) continuous turbidity monitoring equipment for raw and settled water. Each filter shall be equipped with a continuous, on-line turbidimeter. The filter effluent turbidimeters shall be nephelometric type and equipped with alarms to be set to enunciate at five tenths (0.50) nephelometric turbidity units. Continuous recorders or computer data which record at no greater than fifteen (15) minute intervals are required for each unit.

(xi) Backwash—Provisions shall be made for washing filters as follows:

(A) A minimum rate of fifteen (15) gallons per square foot per minute, consistent with water temperatures and specific gravity of the filter media or a rate necessary to provide for a fifty (50) percent expansion of the filter bed is required.

(B) Filtered water shall be provided at the required rate by washwater tanks, a washwater pump, from the high service main, a combination of these, or by other means acceptable to the Department;

(C) Washwater pumps in duplicate are required unless an alternate means of obtaining washwater is available;

(D) Capacity for at least twenty (20) minute wash of one filter is required at the design rate of wash;

(E) A washwater regulator or valve on the main washwater line to obtain the desired rate of filter wash with the washwater valves on the individual filters open wide;

(F) A rate-of-flow indicator, preferably with a totalizer, is required on the main washwater line, and shall be located so that it can be easily read by the operator during the washing process;

(G) The design shall prevent rapid changes in backwash water flow; and,

(H) A treatment of filter backwash designed in accordance with R.61-58.3 (F) shall be provided.

(b) High Rate Gravity Filters—No rates above four (4) gallons per minute per square foot will be considered without full scale pilot tests of at least twelve (12) month duration. High rate approval will not be considered for a plant with a flashy raw water source unless adequate off-stream storage is provided. High rate approval for existing plants requires an engineering evaluation and will be approved only where a sufficient number of experienced and qualified operators are employed. Where high rate approval will not allow a plant to maintain minimum unit process detention times specified in R.61-58.3.D(2), evaluations of those unit processes must be included in the pilot test and high rate engineering evaluation. The design of high rate gravity filters shall be in accordance with all applicable requirements of R.61-58.3.D(5).

(c) Rapid Rate Pressure Filters—Pressure filters will not be allowed as primary filtration on surface waters.

(d) Diatomaceous earth filtration will not be allowed as primary filtration on surface waters.

(i) Conditions of use—Diatomaceous earth filters are expressly excluded from consideration for bacteria removal, color removal, or turbidity removal where either the gross quantity of turbidity is high or the turbidity exhibits poor filterability characteristics, and filtration of waters with high algae counts.

(ii) Pilot plant study—Installation of a diatomaceous earth filtration system shall be preceded by a pilot plant study on the water to be treated.

(A) Conditions of the study such as duration, filter rates, head loss accumulation, slurry feed rates, turbidity removal, bacteria removal, etc., shall be approved by the Department prior to the study.

(B) Satisfactory pilot plant results shall be obtained prior to preparation of final construction plans and specifications.

(C) The pilot plant study shall demonstrate the ability of the system to meet applicable drinking water standards at all times.

(iii) Types of filters—Pressure or vacuum diatomaceous earth filtration units will be considered for approval.

(iv) Treated water storage—Treated water storage capacity in excess of normal requirements shall be provided to allow operation of the filters at a uniform rate during all conditions of system demand at or below the approved filtration rate, and guarantee continuity of service during adverse raw water conditions without by-passing the system.

(v) Number of filtration units—At least two (2) units shall be provided.

(vi) Precoat—A uniform precoat of at least $\frac{1}{16}$ inch shall be applied hydraulically to each septum by introducing a slurry to the tank influent line and employing either a filter-to-waste or recirculation system.

(vii) Body feed—A body feed system to apply additional amounts of diatomaceous earth slurry during the filter run is required. Continuous mixing of the body feed slurry shall be provided.

(viii) Filtration

(A) Rate of filtration—The filtration rate shall be controlled by a positive means and shall not exceed one and a half (1.5) gallons per minute per square foot of filter.

(B) Head loss—The head loss shall not exceed thirty (30) pounds per square inch for pressure diatomaceous earth filters, or a vacuum of fifteen (15) inches of mercury for a vacuum system.

(C) Recirculation—A recirculation or holding pump shall be employed to maintain differential pressure across the filter when the unit is not in operation in order to prevent the filter cake from dropping off the filter elements. A minimum recirculation rate of one tenth (0.1) gallon per minute per square foot of filter area shall be provided.

(D) Septum or filter element—The filter elements shall be structurally capable of withstanding maximum pressure and velocity variations during filtration and backwash cycles, and shall be spaced such that no less than one (1) inch is provided between elements or between any element and a wall.

(E) Inlet design—The filter influent shall be designed to prevent scour of the diatomaceous earth from the filter element.

(ix) Backwash—A satisfactory method to thoroughly remove and dispose of spent filter cake shall be provided. Treatment is required for the backwash water and shall be designed in accordance with applicable portions of R.61-58.3 (F).

(x) Appurtenances—The following shall be provided for every filter:

(A) sampling taps for raw and filtered water;

(B) loss of head or differential pressure gauge;

(C) rate-of-flow indicator, with totalizer;

(D) a throttling valve used to reduce rates below normal during adverse raw water conditions; and,

(E) an evaluation of the need for body feed, recirculation, and any other pumps, in accordance with R.61-58.4(B)(1)(d).

(xi) Monitoring—A continuous monitoring turbidimeter with recorder is required on the filter effluent.

(e) Direct Filtration—The use of direct filtration technology will be considered only where sufficient raw water quality and engineering data is submitted to justify such. No rates above four (4) gallons per minute per square foot will be considered without full scale pilot tests of at least twelve (12) month duration. The following shall be met for direct filtration approval:

(i) Off stream raw water storage must be provided, unless a consistent raw water quality can be demonstrated to the satisfaction of the Department.

(ii) The flocculation chamber design shall be based on pilot plant studies in conjunction with applicable portions of R.61-58.3(D)(2).

(iii) Each filter must meet the basic requirements of a rapid rate gravity filter as given in R.61-58.3(D)(5).

(iv) Filters shall be provided with either rapid rate dual or mixed media specified for filtration rates of four (4) gallons per minute per square foot or greater.

(v) Surface wash, subsurface wash and/or air scour facilities designed in accordance with R.61-58.3(D)(5)(a)(viii) and R.61-58.3(D)(5)(a)(ix) for each filter.

(vi) Each direct filtration plant shall have continuous turbidity monitoring equipment for raw and settled water. Each filter shall be equipped with a continuous, on-line turbidimeter. The filter effluent turbidimeters shall be nephelometric type and equipped with alarms set to enunciate at five tenths (0.50) nephelometric turbidity units. Continuous recorders or computer data are required for each unit.

(vii) Continuous recording devices may be required for loss of head and rate of flow instrumentation.

(viii) Provisions for filtration to waste with appropriate measures for backflow prevention are required.

(6) Disinfection—Disinfection may be accomplished with gas chlorine, chlorine dioxide, ozone or chloramines. Other agents will be considered by the Department provided that reliable feed equipment is available and test procedures for a residual are recognized, and the agent meets the requirements of an acceptable drinking water additive. Continuous disinfection will be required at all surface water supplies. Due consideration shall be given to the contact time of the disinfectant in water with relation to pH, ammonia, taste-producing substances, temperature, bacterial quality, and other pertinent factors. Consideration also must be given to the formation of disinfection by-products and meeting the contact times prescribed in R.61-58.10.

(a) Chlorination—Where chlorine is used the following shall apply:

(i) Type—Only vacuum type gas chlorinators are acceptable.

(ii) Capacity—The chlorinator capacity shall be such that a free chlorine residual of at least five (5) milligram per liter can be attained in the water after a contact time of at least thirty (30) minutes at maximum flow rates. The equipment shall be of such design that it will operate accurately over the desired feeding range.

(iii) Number of units—at least one (1) backup chlorinator shall be provided in addition to the number required for each primary feed point. The backup chlorinator shall be equal to the capacity of the largest chlorinator in use.

(iv) Automatic Proportioning—Automatic proportioning chlorinators will be required where the rate of flow or chlorine demand is not reasonably constant or where the rate of flow of the water is not manually controlled.

(v) Residual Chlorine—Where alternate disinfectants are used in the treatment process, the capability for the addition of either free or combined chlorine in the finished water shall be provided. Residual chlorine must be sufficient to meet the applicable requirements of R.61-58.10.

(b) Cross connection protection—The chlorinator water supply piping shall be designed to prevent contamination of the treated water supply by sources of questionable quality.

(c) Chlorine gas—Consideration shall be given to the location of gas chlorine facilities and the safety of the public in the surrounding area. Consideration may be given for facilities that propose the use of chlorine gas in inhabited areas when the use of safety devices which will not allow the release of chlorine gas (e.g. chlorine scrubbers) are provided. Only vacuum gas chlorinator systems will be approved.

(i) Chlorine gas feed shall be enclosed and separated from other operating areas. Concrete, wood, and other construction materials shall be sealed to prevent the escape of chlorine gas from the chlorine building. The chlorine room shall be provided with a shatter resistant inspection window installed in an interior wall or an inspection window in the door. It shall be

constructed in such a manner that all openings between the chlorine room and the remainder of the plant are sealed, and shall be provided with doors ensuring ready means of exit and opening only to the building exterior.

(ii) Full and empty cylinders of chlorine gas shall be isolated from operating areas, restrained in position to prevent upset, stored in rooms separate from ammonia storage, and stored in areas not in direct sunlight or exposed to excessive heat.

(iii) If the chlorine room is large enough for a person to enter, the room shall be constructed such that:

(A) It has a ventilating fan with a capacity which provides one complete air change per minute;

(B) The ventilating fan shall be located near the ceiling and pull suction through a duct extending to within twelve (12) inches of the floor and discharge as far as practical from the door and air inlet. The point of discharge shall be located so as not to contaminate air inlets to any rooms or structures. A sealed motor or other means shall be used to ensure the reliability of the fan;

(C) Air inlets shall be located near the ceiling;

(D) Air inlets and outlets shall have mechanical louvers;

(E) Switches for fans and lights are outside of the room, at the entrance;

(F) Vents from feeders and storage areas discharge to the outside atmosphere, above grade and away from inlet vent; and,

(G) Ventilation shall not be automatically controlled.

(iv) If the room is too small for a person to enter, the room must meet only R.61-58.3(D)(2)(c)(iii)(E) and (F).

(v) Chlorine feed lines shall meet the following requirements:

(A) Chlorine gas under pressure shall be piped with schedule eighty (80) stainless steel or schedule eighty (80) seamless carbon steel. No chlorine gas under pressure will be piped beyond the chlorinator room.

(B) Chlorine gas under vacuum shall be piped with schedule eighty (80) PVC or reinforced fiberglass.

(C) Chlorine solution shall be piped with schedule eighty (80) PVC.

(vi) Heaters shall be provided to maintain proper temperature for operation.

(vii) There shall be no equipment housed in the chlorine room except chlorinators, chlorine cylinders, weighing scales, heater, ventilation fan, and light(s).

(viii) Weighing scales shall be provided for weighing cylinders, at all installations utilizing chlorine gas unless provisions for automatic switchover of cylinders and an acceptable alternate means to determine daily dosage are provided.

(ix) Chlorine feed systems shall be designed to ensure continuous feed of chlorine.

(x) If a floor drain is provided, it shall be equipped with a water seal or trap to prevent escaped gases from exiting through the building sewer.

(xi) A chlorine leak detection and alarm system shall be provided.

(d) Ozone—Ozone is a suitable disinfectant for surface water. When used as a pre-treatment chemical for surface water, provisions shall be made for post chlorination or chloramination. Consideration shall be given to potential algae growth, removal of assimilated carbon from treated waters, and the formation of oxidized organics. On-site generation facilities shall be constructed in accordance with manufacturer's standards.

(i) Pilot plant tests—Pilot plant tests shall be performed with the water to be treated to establish the optimum dosage, contact time, depth of conductor and the need for multiple application points.

(ii) Number of Units—At least two (2) generators shall be provided. The facility shall be adequately sized to provide the maximum treatment capacity with one generator out of service.

(iii) Building Design—Ozone generators shall be housed in a separate room with separate heating and ventilation. The building layout must provide for easy access to the equipment. Ventilation equipment shall be two (2) speed with the normal speed providing the normal distribution of heat or air movement. The second speed must be capable of providing a complete turnover of the air in the room every two (2) minutes to exhaust any ozone leakage in an emergency.

(iv) Piping Materials

(A) All dry ozone gas piping shall be mechanical jointed number 304 or 316 stainless steel or welded 304L or 316L stainless steel. All wet ozone gas piping shall be number 316 or 316L stainless steel. All flexible couplings shall be stainless steel.

(B) Valves shall be stainless steel face and body.

(C) Gasket materials shall be resistant to deterioration by the ozone.

(v) Reinforced concrete or stainless steel are acceptable materials. All concrete joints shall be sealed using a synthetic rubber material resistant to deterioration by ozone.

(e) Other disinfection agents—Any proposal for the use of other disinfecting agents shall be approved by the Department prior to preparation of final plans and specifications.

(f) Ammonia Gas—Consideration shall be given to the location of ammonia gas facilities and the safety of the public in the surrounding area. Only vacuum ammonia systems will be approved.

(i) Ammonia gas feed shall be enclosed and separated from other operating areas. Concrete, wood, and other construction materials shall be sealed to prevent the escape of ammonia gas from the room. The ammonia room shall be provided with a shatter resistant inspection window installed in an interior wall or an inspection window in the door. It shall be constructed in such a manner that all openings between the ammonia room and the remainder of the plant are sealed, and shall be provided with doors ensuring ready means of exit and opening only to the building exterior.

(ii) Full and empty cylinders of ammonia gas shall be isolated from operating areas, restrained in position to prevent upset, stored in rooms separate from chlorine storage, and stored in areas not in direct sunlight or exposed to excessive heat.

(iii) If the ammonia room is large enough for a person to enter, the room shall be constructed such that:

(A) It has a ventilating fan with a capacity which provides one complete air change per minute;

(B) The ventilating fan shall be located and pull suction near the ceiling and discharge as far as practical from the door and air inlet. The point of discharge shall be located so as not to contaminate air inlets to any rooms or structures. A sealed motor or other means shall be used to ensure the reliability of the fan;

(C) Air inlets shall be located near the floor;

(D) Air inlets and outlets shall have mechanical louvers;

(E) Switches for fans and lights are outside of the room, at the entrance;

(F) Vents from feeders and storage areas discharge to the outside atmosphere, above grade and away from inlet vent; and,

(G) Ventilation shall be automatically controlled.

(iv) If the room is too small for a person to enter, the room must meet only R.61-58.3(D)(2)(f)(iii)(E), and (F).

(v) Ammonia feed lines shall not carry ammonia gas beyond the ammonia room.

(vi) There shall be no equipment housed in the ammonia room except ammoniators, ammonia cylinders, weighing scales, heater, ventilation fan, and light(s).

(vii) Weighing scales shall be provided for weighing cylinders, at all plants utilizing ammonia gas from cylinders. Where bulk storage tanks are installed, they shall be equipped with a pressure gauge.

(viii) Ammonia leak detectors with alarms shall be provided.

(g) Chlorine Dioxide - Chlorine Dioxide is a suitable disinfectant for surface water. Chlorine dioxide shall be generated on site. The unit shall be flow paced and not have a holding tank for the chlorine dioxide solution generated. All applicable EPA disinfectant by-product rules shall be observed.

(i) Sizing of the chlorine dioxide generator - Chlorine dioxide demand studies shall be conducted to determine estimated feed rates and points of feed.

(ii) Building Design -

(A) Chlorine dioxide generators shall be located in a room separate from chlorine cylinders.

(B) Number of Units: Where chlorine dioxide is used as the primary disinfectant, at least two (2) flow pacing chlorine dioxide generators shall be provided. The facility shall be adequately sized to supply the maximum treatment capacity with any one generator out of service. If chlorine dioxide is not used as a primary disinfectant (i.e. an oxidant only), a second generator is not required.

(iii) Piping Materials -

(A) All piping from the chlorine dioxide generator shall be schedule 80 PVC.

(B) Gasket materials shall be kynar or other compatible material.

(C) All tubing connector fittings shall be kynar or other compatible material.

(7) Aeration—Aeration treatment devices, as described herein, may be used for oxidation, separation of gases or for taste and odor control.

(a) General Requirements

(i) Sample taps must be provided following aeration equipment.

(ii) Where aeration equipment discharges directly to the distribution system, air release valves must be provided.

(b) Natural Draft Aeration—Design shall provide that:

(i) Water is distributed uniformly over the top tray;

(ii) Water is discharged through a series of three (3) or more trays with the separation of trays not less than twelve (12) inches;

(iii) Trays are loaded at a rate of one (1) gallon per minute to five (5) gallons per minutes for each square foot of total tray area;

(iv) Trays have slotted, woven wire cloth or perforated bottoms;

(v) Perforation are three sixteenth ($\frac{3}{16}$) to one-half ($\frac{1}{2}$) inches in diameter, spaced one (1) to three (3) inches on centers, when perforations are used in the distribution pan;

(vi) Construction of durable material resistant to the aggressiveness of the water and dissolved gases;

(vii) Protection of aerators from loss of spray water by wind carriage by enclosure with louvers sloped to the inside at an angle of approximately forty-five (45) degrees;

(viii) Protection from insects by number twenty-four (24) mesh screen; and,

(ix) Aerated water receives disinfection treatment.

(c) Forced or Induced Draft Aeration—Devices shall be designed to:

(i) Provide an adequate countercurrent of air through the enclosed aeration column;

(ii) Include a blower in a screened enclosure and with a watertight motor;

(iii) Exhaust air directly to the outside atmosphere;

(iv) Include a down-turned, number twenty-four (24) mesh screened air outlet and inlet;

(v) Be such that air introduced in the column shall be as free from noxious fumes, dust, and dirt as possible;

(vi) Be such that sections of the aerator can be easily reached or removed for maintenance of the interior;

(vii) Provide loading at a rate of one (1) to five (5) gallons per minute for each square foot of total tray area;

(viii) Ensure that the water outlet is adequately sealed to prevent the unwarranted loss of air;

(ix) Discharge through a series of five (5) or more trays, with separation of trays not less than six (6) inches;

(x) Provide distribution of water uniformly over the top tray; and,

(xi) Be of a durable corrosive resistant material.

(d) Pressure Aeration—This method may be used for oxidation purposes if pilot plant study indicates method is applicable. It is not acceptable for removal of dissolved gases. Filters following pressure aeration shall have adequate exhaust devices for release of air. Pressure aeration devices shall be designed to give thorough mixing of compressed air with water being treated. Screened and filtered air, free of noxious fumes, dust, dirt and other contaminants shall be provided.

(e) Other Methods of Aeration—Other methods of aeration may be used if applicable to the treatment needs. Such methods may include, but are not restricted to, spraying, diffused air, cascades, and mechanical aeration. The treatment processes shall be designed to meet the particular needs of the water to be treated and shall be subject to Department approval.

(8) Fluoridation—Commercial sodium fluoride, sodium silicofluoride and hydrofluorosilic acid shall be NSF approved and shall conform to American Waterworks Association Standards B701, B702 and B703, respectively. Fluoride chemicals shall meet the requirements of chemical additives in R.61-58.2(E)(3). The proposed method of fluoride feed shall be approved by the Department prior to preparation of final plans and specifications.

(a) Fluoride Compound Storage - Dry chemical storage shall be designed in accordance with R.61-58.3.E(2)(e). Storage units for hydrofluorosilic acid shall be isolated from operating areas and shall be vented to the atmosphere at a point outside any building.

(b) Dry Conveyors—Provisions shall be made for the proper transfer of dry fluoride compounds from shipping containers to storage bins or hoppers, in such a way as to minimize the quantity of fluoride dust.

(c) Injection Point—The fluoride compound shall not be added before lime addition, to avoid precipitation of fluoride.

(d) Chemical Feed Installations—Fluoride feed systems shall meet the following criteria:

(i) Scales or loss-of-weight recorders for weighing the quantity of chemicals added shall be provided;

(ii) Feed equipment shall have an accuracy to within five (5) percent of any desired feed rate;

(iii) The point of application of hydrofluorosilic acid, if into a pipe, shall be in the lower half of the pipe and project upward at an angle approximately forty (40) degrees and extend into the pipe one-third of diameter; and,

(iv) All fluoride feed lines shall be provided with adequate antisiphon devices.

(v) All fluoride feed systems shall be equipped with a fail-safe system to prevent the continued feed of fluoride at times when there is no flow of water through the fluoride feed point.

(e) Protective equipment—At least one (1) pair of rubber gloves, a respirator of a type certified by the National Institute for Occupational Safety and Health for toxic dusts or acid gas (as necessary), an apron or other protective clothing, and goggles or face masks shall be provided for use by the operator. Other protective equipment may be required, as deemed necessary by the Department.

(f) Dust Control

(i) Provisions shall be made for the transfer of dry fluoride compounds from shipping containers to storage bins or hoppers in such a way as to minimize the quantity of fluoride dust which may enter the room in which the equipment is installed. The enclosure shall be provided with an exhaust fan and dust filter to the outside atmosphere of the building.

- (ii) Provisions shall be made for disposing of empty bags, drums and barrels in a manner which will minimize exposure to fluoride dusts. A floor drain shall be provided to facilitate the washing of floors.
- (9) Corrosion Control—Water that is corrosive due either to natural causes or to treatment given the water shall be rendered non-corrosive, and nonaggressive before being pumped to the distribution system.
 - (a) Alkali Feed—Corrosive water due to natural occurrence, created by the addition of alum or other coagulant, shall be treated by an alkali feed. Alkali feed can consist of lime, soda ash, bicarbonate, caustic soda, or a combination of any of the above. Lime feed systems shall include a mechanism for flushing the feed lines, including suction and pumping equipment, if used.
 - (b) Phosphates—The feeding of phosphates may be applicable for corrosion control. Phosphate chemicals shall meet the requirements of chemical additives in R.61-58.3(E)(3).
 - (c) Carbon dioxide addition
 - (i) Recarbonation basin design shall provide:
 - (A) a total detention time of at least twenty (20) minutes.
 - (B) two (2) compartments, each with a depth of eight (8) feet, consisting of a mixing compartment having a detention time of at least three (3) minutes, and a reaction compartment.
 - (ii) Adequate precautions shall be taken to prevent the possibility of carbon monoxide entering the plant from recarbonation compartments.
 - (iii) Provisions shall be made for draining the recarbonation basin and removing sludge.
 - (d) Other Treatment—Other treatment for controlling corrosive waters will be considered on a case by case basis. All chemicals must meet the requirements in R.61-58.3(E)(3). Any proprietary compound must receive the specific approval of the Department before use.
 - (e) Control—Laboratory equipment, acceptable to the Department, shall be provided to test for the compounds being fed.
- (10) Taste and Odor Control—Provision shall be made for the addition of taste and odor control chemicals at all surface water treatment plants. These chemicals shall be added sufficiently ahead of other treatment processes to ensure adequate contact time for an effective and economical use of the chemicals.
 - (a) Flexibility—Plants treating water that is known to have taste and odor problems shall be provided with equipment that makes several of the control processes available to allow the operator flexibility in operation.
 - (b) Chlorination—Chlorination can be used for the removal of some objectionable odors. Adequate contact time must be provided to complete the chemical reactions involved. Consideration shall be given to disinfection by-products if this method is used.
 - (c) Chlorine Dioxide—Chlorine dioxide may be used in the treatment of taste or odor. Provision shall be made for the proper storing and handling of sodium chlorite, so as to eliminate any danger of explosion. Consideration shall be given to disinfection by-products if this method is used.
 - (d) Powdered Activated Carbon—Where added, powder activated carbon feed systems shall meet the following criteria:
 - (i) Powdered activated carbon may be added prior to coagulation to provide maximum contact time, but shall not be added near the point of chlorine application.
 - (ii) Provisions shall be made for adequate dust control.
 - (iii) Provision shall be made for adding at least forty (40) milligrams per liter.
 - (e) Granular Activated Carbon Absorption Units—Rates of flow shall be consistent with the type and intensity of the problem. The rate used shall be supported by the results of pilot plant studies and shall be accordance with the requirements of R.61-58.3(D)(5).
 - (f) Copper Sulfate and Other Copper Compounds—Continuous or periodic treatment of water with copper compounds to kill algae or other growths shall be controlled to prevent copper in

excess of one (1) milligrams per liter as copper in the plant effluent or distribution system. Care shall be taken in obtaining a uniform distribution. Department approval shall be obtained prior to the use of any such compound.

(g) Aeration—Aeration units used for taste and odor removal shall be designed in accordance with R.61-58.3(D)(7).

(h) Potassium Permanganate—The application of potassium permanganate may be considered, provided that dosages are determined by permanganate demand testing.

(11) Membrane Technology - All applications for projects involving membrane technology must be preceded by an engineering report and may require a pilot study. The engineering report must meet the requirements of R.61-58.1.C.

(a) General Requirements

(i) Membrane material - No membrane material shall be used in a public water system unless the material or product has been tested and certified as meeting the specifications of the American National Standard Institute/National Sanitation Foundation Standard 61, Drinking Water System Components - Health Effects. This requirement shall be met under testing conducted by a third party product certification organization accredited for this purpose by the American National Standards Institute.

(ii) Loading rates must be determined by pilot testing and/or manufacturers recommendations.

(iii) Scale Inhibitors and Cleaning Solutions - Where required, scale inhibitors and cleaning solutions must meet the requirements of chemical additives R.61-58.3.E(3).

(b) Electrodialysis Reversal—Electrodialysis reversal treatment shall not be used on surface water or groundwater under the direct influence of surface water.

E. Chemical Application.

(1) General—No chemical shall be applied to treat drinking waters unless specifically approved by the Department.

(a) Plans and specifications—Plans and Specifications shall be submitted for review and approval, as required by in R.61-58.1, and shall include:

(i) descriptions of feed equipment, including maximum and minimum feed ranges and pump curves for solution feeders,

(ii) location of feeders, piping layout and points of chemical application;

(iii) storage and handling facilities;

(iv) specifications for chemicals to be used;

(v) operating and control procedures including proposed application rates;

(vi) descriptions of testing equipment and procedures; and,

(vii) locations of sampling taps for testing.

(b) Chemical application—Chemicals shall be applied to the water at such points and by such means as to:

(i) provide maximum efficiency of treatment;

(ii) ensure maximum safety to consumer;

(iii) provide maximum safety to operators;

(iv) ensure satisfactory mixing of the chemicals with the water;

(v) provide maximum flexibility of operation through various points of application, when appropriate,

(vi) prevent backflow or back-siphonage between multiple points of feed through the use of separate feed equipment for each point and backflow preventers where a manifold system is used for standby, multiple feed use;

(vii) provide a separate injection point and a separate feed line for each chemical application that is added and spacing to prevent inter-reaction of chemicals; and,

(viii) provide chemical injection points which are readily accessible. All below-grade injection points shall be housed in a vault or similar structure.

(c) General equipment design—General equipment design shall be such that:

(i) chemical-contact materials and surfaces are corrosion resistant;

(ii) corrosive chemicals are introduced in such a manner as to minimize potential for corrosion; and,

(iii) chemicals that are incompatible are not fed, stored or handled together.

(2) Facility Design

(a) Chemical feeders

(i) A separate feeder shall be used for each separate chemical applied, and for each injection point.

(ii) Spare parts shall be available for all feeders to replace parts which are subject to wear and damage.

(iii) Dry chemical feeds shall:

(A) measure chemicals volumetrically or gravimetrically;

(B) provide adequate solution water and agitation of the chemical in the solution pot;

(C) provide gravity feed from solution pots; and,

(D) completely enclose chemicals to prevent emission of dust into the operating room and/or provide dust collection units.

(iv) When a booster pump is required, duplicate equipment shall be provided; and, when necessary, standby power shall be provided. Where chemical feed is necessary for the protection of the supply, such as chlorination, coagulation, or other essential processes:

(A) A minimum of two (2) feeders shall be provided; and,

(B) The standby unit or a combination of units of sufficient capacity shall be available to replace the largest unit during shut-downs.

(v) Chemical feed equipment shall be located in a separate room to reduce hazards and dust problems; shall be conveniently located near points of application to minimize length of feed lines; and, shall be readily accessible for servicing, repair, and observation of operation.

(vi) Feeders shall be able to supply, at all times, the necessary amount of chemicals at an accurate rate.

(b) Control

(i) Feeders with automatic controls shall be designed so as to allow override by manual controls.

(ii) Chemical feed rates shall be proportional to flow.

(iii) Meters, scales, calibration columns, or other acceptable means to measure chemicals being fed must be provided in order to determine chemical feed rates.

(iv) Provisions shall be made for measuring the quantities of chemicals used.

(c) Cross-connection control

(i) Cross connection control shall be provided to ensure that liquid chemical solutions cannot be siphoned through solution feeders into the water supply.

(ii) The service water lines discharging to the solution tanks shall be properly protected from backflow as required by the Department.

(iii) No direct connection shall exist between any sewer and a drain or overflow from the feeder, solution chamber or tank. All drains shall terminate at least six (6) inches or two (2) pipe diameters, whichever is greater, above the overflow rim of a receiving sump, conduit or waste receptacle.

(d) Service Water Supply—Service water supply shall be ample in supply and adequate in pressure; shall be properly treated potable water; shall be properly protected against backflow;

and, a means shall be provided to measure the quantity of water used in preparing specific solution concentrations by dilution;.

(e) Storage of chemicals

(i) Space shall be provided for at least thirty (30) days of chemical supply and provide for convenient, efficient and safe handling of chemicals. Dry storage conditions must be maintained for dry chemicals.

(ii) Storage tanks and pipelines for liquid chemicals shall be designed specifically for each chemical used.

(iii) Chemicals shall be stored in covered or unopened shipping containers, unless the chemical is transferred into an approved covered storage unit.

(iv) Liquid chemical storage tanks shall have:

(A) a liquid level indicator;

(B) an overflow; and,

(C) secondary containment capable of receiving and containing accidental spills or overflows. Consideration must be given to reactivity of chemicals stored in a single containment area.

(f) Solution tanks

(i) A means which is consistent with the nature of the chemical solution shall be provided in a solution tank to maintain a uniform strength of solution. Continuous agitation shall be provided to maintain slurries in suspension.

(ii) Two solution tanks of adequate volume may be required for a chemical to ensure continuity of supply in servicing a solution tank.

(iii) Means shall be provided to measure the solution level in the tank.

(iv) Chemical solutions shall be kept covered. Large tanks with access openings shall have such openings curbed and fitted with tight overhanging covers.

(v) Surface locations for solution tanks shall:

(A) be free from sources of possible contamination; and,

(B) Ensure positive drainage from ground waters, accumulated water, chemical spills and overflows from around tank.

(vi) Overflow pipes, when provided, shall:

(A) be turned downward, with the end screened;

(B) have an air gap of two (2) pipe diameters or six (6) inches, whichever is greater; and,

(C) be located where noticeable.

(vii) Acid storage tanks shall be independently vented to the outside atmosphere.

(viii) Each tank shall be provided with a valved drain, protected against backflow in accordance with R.61-58.3(E)(2)(c)(iii).

(ix) Solution tanks shall be provided with protective curbing, drains or other secondary containment capable of receiving and containing accidental spills or overflows.

(g) Day tanks

(i) Day tanks shall be provided where bulk storage of liquid chemical is provided.

(ii) Day tanks shall meet all the requirements of R.61-58.3.E(2)(f).

(iii) Day tanks shall be scale-mounted, or have a calibrated gauge painted or mounted on the side so liquid level can be observed in a gauge tube or through translucent sidewalls of the tank. In opaque tanks, a gauge rod extending above a reference point at the top of the tank, attached to a float may be used. The ratio of the area of the tank to its height shall be such that unit readings are meaningful in relation to the total amount of chemical fed during a day.

(iv) Hand pumps may be provided for transfer from a carboy or drum. A tip rack may be used to permit withdrawal into a bucket from a spigot. Where motor-driven transfer pumps are

provided, a liquid level limit switch and an overflow from the day tank, which will drain back into the bulk storage tank or other approved location, shall be provided.

(v) Tanks shall be properly labeled to designate the chemical contained.

(h) Feed lines

(i) Feed lines shall be as short as possible in length of run, and of durable, corrosion resistant material. They shall be easily accessible throughout the entire length, protected against freezing, and readily cleanable.

(ii) Feed lines shall be designed consistent with scale-forming or solids depositing properties of the water, chemical, solution or mixture conveyed.

(iii) Feed lines shall be color coded and labeled.

(iv) Where lime is added, a spare feed line equal in length to the longest run of feed line, shall be provided.

(i) Handling

(i) Carts, elevators and other appropriate means shall be provided for lifting chemical containers.

(ii) Provisions shall be made for disposing of empty bags, drums or barrels by an approved procedure which will minimize exposure to dust.

(iii) Provision shall be made for the proper transfer of dry chemicals from shipping containers to storage bins or hoppers, in such a way as to minimize the quantity of dust which may enter the room in which the equipment is installed.

(iv) Provision shall be made for measuring quantities of chemicals used to prepare feed solutions.

(j) Housing

(i) Floor surfaces shall be smooth, impervious, slip-proof and well-drained.

(ii) Vents from feeders, storage facilities and equipment exhaust shall discharge to the outside atmosphere above grade and remote from air intakes.

(iii) Feeders used in conjunction with dry lime or carbon shall be housed in separate, individual rooms equipped with dust control systems.

(iv) Sufficient lighting for operator safety and sufficient heating to provide for proper operation of the chemical feed equipment shall be provided for all chemical feed rooms.

(3) Chemicals Specifications—All chemicals and products added to a public water supply as part of the treatment process shall be certified as meeting the specifications of the American National Standards Institute/National Sanitation Foundation Standard 60, Drinking Water Treatment Chemicals—Health Effects. The certifying party shall be accredited by the American National Standards Institute.

F. Waste Handling and Disposal.

Waste handling and disposal practices shall meet all applicable rules and regulations of the Department. Provisions must be made for proper disposal of water treatment plant waste such as sanitary, laboratory, clarification sludge, softening sludge, iron sludge, filter backwash water, filter to waste, and brine waste. In locating waste disposal facilities, due consideration shall be given to preventing potential contamination of the water supply. For projects involving a surface water discharge of water treatment residuals or waste water, a National Pollutant Discharge Elimination System (NPDES) permit must be obtained from the Department. For projects involving land application of water treatment residuals or waste water, a No Discharge (ND) permit must be obtained from the Department.

(1) Sanitary Waste—The sanitary waste from water treatment plants, pumping stations, etc., must receive treatment. Waste from these facilities must be discharged directly to a sanitary sewer system, when feasible, or to an adequate on-site waste treatment facility.

(2) Alum Sludge—Mechanical concentration or lagooning may be used as a method of handling alum sludge. Acid treatment of sludge for alum recovery may be a possible alternative. Alum sludge

can be discharged to a sanitary sewer only if acceptable to the receiving sewer system and approved by the Department before final designs are made.

(a) Lagoons shall be designed to shall meet the following requirements:

(i) A minimum of two (2) lagoons are required for handling alum sludge.

(ii) The location shall be such that the top of the dike is at least one (1) foot above the one hundred (100) year flood plain;

(iii) Where necessary, dikes, deflecting gutters or other means of diverting surface water runoff shall be provided so that it does not flow into the lagoon;

(iv) A minimum usable depth of five (5) feet with adequate freeboard shall be provided so as not to interfere with normal plant operation;

(v) Dikes shall be constructed of relatively impervious material and compacted to at least ninety (90) percent Standard Proctor Density to form a stable structure. Vegetation and other unsuitable materials shall be removed. Minimum dike width shall be eight (8) feet. Dike slopes shall not be steeper than one (1) foot vertical to three (3) feet horizontal;

(vi) A minimum separation of four (4) feet between the bottom of the lagoon and the maximum groundwater elevation shall be maintained;

(vii) A synthetic liner of at least twenty (20) mil (0.20 inches) thickness or a natural liner consisting of one foot of compacted clay having a hydraulic conductivity (coefficient of permeability) of no more than .0000001 centimeters per second shall be used;

(viii) A monitoring system shall be constructed to measure the water quality in the upper most aquifer. One (1) upgradient monitoring well and an adequate number of down gradient monitoring wells, so as to fully define any potential leachate plume, shall be provided;

(ix) An adjustable decanting device must be provided;

(x) Effluent sampling point and flow measurement device must be provided;

(xi) Erosion control through grassing, rip-rap, or other means is required on both the inside and outside dike surfaces; and,

(xii) Adequate safety provisions must be installed.

(b) Mechanical concentration or de-watering—A pilot study is required before the design of a mechanical de-watering installation. Provisions shall be made for holding basins so as to maintain continuity of service of the water plant. Vacuum filters, centrifuges, filter presses, belt presses, or other devices will be considered.

(3) Lime softening sludge—Methods of treatment and disposal are as follows:

(a) Lagoons

(i) Temporary lagoons which must be cleaned periodically shall be designed on the basis of seven tenths (0.7) acres per million gallons per day per one hundred (100) milligrams per liter of hardness removed based on a usable lagoon depth of five (5) feet. At least two (2) lagoons must be provided in order to give flexibility in operation. An acceptable means of final sludge disposal must be provided. Provisions must be made for convenient cleaning.

(ii) Permanent lagoons shall have a volume of at least four (4) times that for temporary lagoons.

(iii) The design of both temporary lagoons and permanent lagoons shall meet the requirements for lagoons in paragraph 2(a) above.

(b) Discharge of lime sludge to sanitary sewers shall be avoided if possible since it may cause both liquid volume and sludge volume problems at the sewage treatment plant. This method shall be used only when the sewer system has the capability to adequately handle the lime sludge and is acceptable to both the sewer system and the Department.

(c) Mechanical de-watering of sludge may be considered. Pilot studies on a particular plant waste are required.

(d) Calcination of sludge may be considered. Pilot studies on a particular plant waste are required.

HISTORY: Amended by State Register Volume 19, Issue No. 7, eff July 28, 1995; State Register Volume 26, Issue No. 5, Part 1, eff May 24, 2002.

61-58.4. Finished Water Pumping, Storage, and Distribution Facilities.

Table of Contents

- A. Applicability
- B. Pumping Facilities
- C. Finished Water Storage
- D. Distribution Systems
- E. Public Buildings
- F. Lead Ban

A. Applicability.

This regulation applies to all new construction and all expansions or modifications of existing public water systems. If the Department can reasonably demonstrate that safe delivery of potable water to the public is jeopardized, a system may have to upgrade its existing facilities in order for an expansion or modification to meet the requirements of this regulation. This regulation prescribes minimum design standards for the construction of finish water pumping, storage, and distribution facilities.

B. Pumping Facilities.

(1) Requirements for Pump Stations—Pumping facilities shall be designed to maintain the sanitary quality of pumped water.

(a) Location—

(i) The pumping station shall be located so that the site will meet the requirements for sanitary protection of water quality, hydraulics of the system and protection against interruption of service by fire, flood or any other hazard.

(ii) The station shall be elevated to a minimum of one (1) foot above the one hundred (100) year flood elevation, or protected to such elevation, shall be readily accessible at all times unless permitted to be out of service for the period of inaccessibility, shall be graded around the station so as to lead surface drainage away from the station, and shall be protected to prevent vandalism and entrance by animals and unauthorized persons.

(b) General Design Considerations—Pump stations shall be of durable construction, fire and weather resistant and with outward-opening doors. The floor elevation of pump stations shall be at least six (6) inches above finished grade, have waterproofed underground structure, and have all floors drained in such a manner that the quality of the potable water will not be endangered. All floors shall slope to a suitable drain and provide a suitable outlet for drainage from pump glands without discharging onto the floor.

(c) Pumping Equipment—

(i) At least two (2) pumping units shall be provided. The pumping station shall be sized adequately to supply the maximum daily demand with any pump out of service. The pumping units shall:

- (A) Be driven by a prime mover able to operate against the maximum head and air temperature which may be encountered;
- (B) Have spare parts and tools readily available;
- (C) Be equipped with elapsed time hour meters for each pump or another acceptable mechanism to monitor run times; and.

(D) Be sized to operate from minimum to maximum pumping conditions without overloading the motor.

(ii) Prime water must not be of lesser sanitary quality than that of the water being pumped. Means shall be provided to prevent back-siphonage. When an air-operated ejector is used, the screened intake shall draw clean air from a point at least ten (10) feet above the ground or other source of possible contamination, unless the air is filtered by an apparatus approved by the Department. Vacuum priming may be used.

(iii) For pumps designed so that bearing lubrication fluids come into contact with the water being pumped, only water lubricated pumps may be used unless otherwise approved by the Department.

(d) Equipment Servicing—Pump stations shall be designed so that proper maintenance of the equipment can be provided.

(e) Operator Access—Pump stations shall be designed for easy access by stairs or ladders when necessary.

(f) Heating—In pump houses not occupied by personnel, only enough heat need be provided to prevent freezing of equipment or treatment process.

(g) Ventilation—Ventilation shall conform to existing local, federal, and/or state codes. Adequate ventilation shall be provided for all pumping stations.

(h) Lighting—Pump stations shall be adequately lighted throughout. All electrical work shall conform to the requirements of the National Electric Code or applicable state and local codes.

(i) Auxiliary Power—Where elevated storage equals less than one half maximum daily demand, portable or in-place auxiliary power shall be provided for all systems serving three hundred (300) or more service connections. An air quality permit may be required for the air emissions from the auxiliary generators. Auxiliary power requirements may be waived if one or more of the following are applicable:

- (i) a verifiable history of worst case power outages and verification that the available elevated storage can provide for a similar time period of outage;
- (ii) two (2) or more independent sources from the serving electrical utility are available; or,
- (iii) an alternate water source is available via connections with other systems.

Auxiliary power shall be sized to provide for sufficient pumping capacity to meet the one half ($\frac{1}{2}$) of the maximum daily demand or to supplement the existing storage to meet one half ($\frac{1}{2}$) of the maximum daily demand.

(j) Protection From Trespassers—Fencing, locks on doors, and other necessary precautions shall be provided to prevent trespassing, vandalism, and sabotage.

(2) Booster Pump Stations—Booster pump stations shall meet all applicable portions of R.61-58.4(B)(1)Paragraph in addition to the requirements below.

(a) Booster pumps shall be located or controlled so that they will not produce less than twenty-five (25) pounds per square inch anywhere in the affected distribution system when the pump is in normal operation. An automatic cutoff switch or throttling valve shall be installed to prevent the pressure anywhere in the affected distribution system from dropping below twenty (20) pounds per square inch. Automatic or remote control devices shall have a range between the start and cutoff pressure which will prevent excessive cycling, and a bypass line shall be provided. Fire booster pumps must have a device to monitor suction pressure and throttle the output of the pump to maintain the suction pressure above twenty (20) pounds per square inch anywhere in the affected distribution system, but, not shut the pump off.

(b) In-line booster pumps shall be accessible for servicing and repairs.

(3) Automatic Pump Stations—All automatic pump stations shall be provided with a warning light or telemetry system which will report when the station is out of service. All remote controlled stations shall be electrically operated and controlled and shall have signaling apparatus of proven performance. Installation of electrical equipment shall conform with the applicable state and local electrical codes and the National Electrical Code. A sign with a twenty-four (24) hour telephone number for

emergencies shall be displayed on the outside of the station in a visible location, unless the system has twenty-four (24) hour monitoring.

(4) Appurtenances—

(a) Valves—Pumps shall be adequately valved to permit satisfactory operation, maintenance and repair of the equipment. Each pump shall have a positive-acting check valve on the discharge side between the pump and the shut-off valve.

(b) Piping—In general, suction and discharge piping shall:

(i) be designed so that the friction losses will be minimized;

(ii) not be subject to contamination;

(iii) be sloped in one direction to drain;

(iv) have watertight joints;

(v) have adequate clean-outs;

(vi) be protected against surge or water hammer; and,

(vii) be manifolded or have an individual suction line to ensure similar hydraulic and operating conditions.

(c) Gauges—Each pump shall:

(i) Have a standard pressure gauge on its discharge line; and,

(ii) Have a compound gauge on its suction line;

(d) Water Seals—Water seals shall not be supplied with water of a lesser sanitary quality than that of the water being pumped. Where pumps are sealed with potable water and are pumping water of lesser sanitary quality the seal shall be provided with a back-flow preventer appropriate for the degree of hazard in question.

(e) Controls—Pumps, their prime movers and accessories, shall be controlled in such a manner that they will operate at rated capacity without dangerous overload. Where two or more pumps are installed, provision shall be made for alternation. Provision shall be made to prevent energizing the motor in the event of a backspin cycle. Electrical controls shall be located above grade.

(f) Water Pre-lubrication—When automatic pre-lubrication of pump bearings is necessary and an auxiliary power supply is provided, the pre-lubrication line shall be provided with a valved bypass around the automatic control so that the bearings can, if necessary, be lubricated manually before the pump is started.

C. Finished Water Storage

(1) General—

(a) Sizing—Where fire flows are provided, tanks shall be sized to provide two (2) hours of supply for a combined flow of peak hour domestic plus fire flow; or, the storage capacity (or equivalent capacity) shall equal one half ($\frac{1}{2}$) the maximum daily consumption, whichever is greater. Either requirement may be reduced when the source and treatment facilities have sufficient capacity with auxiliary power to supplement peak demands of the system.

(b) Isolation of Tank—Storage structures shall be designed so they can be isolated from the distribution system for the purpose of draining, maintenance and repair. A sample tap shall be provided on the tank or on the tank side of the isolation valve.

(c) Level controls—Adequate controls shall be provided to automatically maintain levels in distribution system storage structures. Where telemetry is not provided for water level measurement, a float type level gauge and visible target shall be provided. Altitude valves or equivalent controls may be required for a second and subsequent structures on the system.

(d) All tanks shall be readily accessible at all times for inspection and maintenance.

(2) Atmospheric Ground Storage, Elevated Tanks, and Standpipes.

(a) General—The materials and designs used for finished water storage structures shall provide stability and protection of the stored water. Steel structures shall be designed in accordance with current American Waterworks Association (AWWA) Standard D-100 concerning steel tanks,

standpipes, reservoirs, and elevated tanks whenever they are applicable. Other materials of construction are acceptable when properly designed to meet the requirements of this Section.

(b) Location of ground-level reservoirs

(i) The bottom of reservoirs and standpipes shall be above the one hundred (100) year flood level.

(ii) When the bottom must be below normal ground surface, it shall be placed above the ground water table. Sewers, drains, standing water, and similar sources of possible contamination must be kept at least fifty (50) feet from the reservoir. Water main pipe, pressure tested in place to fifty (50) pounds per square inch without leakage, may be used for gravity sewers at distances greater than twenty (20) feet and less than fifty (50) feet.

(iii) The top of a reservoir shall not be less than two (2) feet above normal ground surface. Clearwells constructed under filters may be exempted from this requirement when the total design gives the same protection.

(c) Sanitary Protection—All finished ground level or elevated water storage structures shall have suitable watertight roofs which exclude birds, animals, insects, and excessive dust.

(d) Protection from trespassers—Fencing, locks on access manholes, and other necessary precautions shall be provided to prevent trespassing, vandalism, and sabotage.

(e) Drains—Adequately sized drains shall be provided. No drain on a water storage structure may have a direct connection to a sewer or storm drain. A flap valve or other means of covering the open outlet of the drain shall be provided.

(f) Overflow—The overflow pipe shall be of sufficient diameter to permit the discharge of water equal to or greater than the filling rate; but shall not be less than four (4) inches in diameter. All atmospheric storage structures shall be provided with an overflow which is brought down to an elevation between twelve (12) and twenty-four (24) inches above the ground surface, and discharges over a drainage inlet structure or a splash pad. A flap valve or number four (4) mesh non-corrodible screen shall be provided on the outlet. No overflow may be connected directly to a sewer or storm drain. All overflow pipes shall be located so that any discharge is visible.

(g) Access—Finished water storage structures shall be designed with reasonably convenient access to the interior for cleaning and maintenance. Manholes above the water-line shall:

(i) be framed at least four (4) inches above the surface of the roof at the opening on ground-level structures;

(ii) be fitted with a solid watertight cover which overlaps the framed opening and extends down around the frame at least two (2) inches; and,

(iii) have a locking device.

(h) Vents—Finished water atmospheric storage structures shall be vented. Overflows shall not be considered as vents. Open construction between the sidewall and roof is not permissible. Twenty-four (24) mesh non-corrodible screens, or equivalent, shall be used on all vents. Vents shall be constructed to:

(i) prevent the entrance of surface water and rainwater;

(ii) exclude birds and animals;

(iii) exclude insects and dust, as much as this function can be made compatible with effective venting.

(iv) “The vent shall be constructed to prevent imploding of the tank during a rapid discharge of water from the tank.”

(i) Roof and sidewall—The roof and sidewalls of all structures must be watertight with no openings except properly constructed vents, manholes, overflows, risers, drains, pump mountings, control ports, or piping for inflow and outflow.

(i) Any pipes running through the roof or sidewall of a finished water storage structure must be welded, or properly gasketed in metal tanks. In concrete tanks, these pipes shall be connected to standard wall castings which were poured in place during the forming of the concrete. These wall castings should have seepage rings imbedded in the concrete.

(ii) Openings in a storage structure roof or top, designed to accommodate control apparatus or pump columns, shall be curbed and sleeved with proper additional shielding to prevent the access of surface or floor drainage water into the structure.

(iii) Valves and controls shall be located outside the storage structure so that the valve stems and similar projections will not pass through the roof or top of the reservoir.

(j) Drainage of roof—The roof of the storage structure shall be well drained. Downspout pipes shall not enter or pass through the reservoir. Parapets, or similar construction which would tend to hold water and snow on the roof, will not be approved unless adequate waterproofing and drainage are provided.

(k) Safety—The safety of employees must be considered in the design of the storage structure.

(i) Ladders, ladder guards, balcony railings, and safely located entrance hatches shall be provided where applicable.

(ii) A platform at the top of the ladder to provide a place for the climber to stand on while unhooking the safety harness shall be provided.

(iii) Elevated tanks with riser pipes over eight (8) inches in diameter shall have protective bars over the riser opening inside the tank.

(l) Freezing—All finished water storage structures and their appurtenances, especially the riser pipes, overflows, and vents, shall be designed to prevent freezing which will interfere with proper functioning.

(m) Internal catwalk—Every catwalk over finished water in a storage structure shall have a solid floor with raised edges so designed that shoe scrapings and dirt will not fall into the water.

(n) Silt stop—The discharge pipes from all reservoirs shall be located in a manner that will prevent the flow of sediment into the distribution system. Removable silt stops should be provided where feasible.

(o) Grading—The area surrounding a ground-level structure shall be graded in a manner that will prevent surface water from standing within a fifty (50) foot radius.

(p) Painting and/or cathodic protection—Proper protection shall be given to metal surfaces by paints or other protective coatings, by cathodic protective devices, or by both. All paint coatings which come into contact with drinking water shall be certified as meeting the specifications of the American National Standard Institute/National Sanitation Foundation Standard 61, Drinking Water System Components—Health Effects. The certifying party shall be accredited by the American National Standards Institute. Hot applied wax, cold applied wax, grease, and coal tar coatings are not acceptable.

(q) Disinfection—Finished water storage structures shall be disinfected in accordance with current American Waterworks Association (AWWA) Standard for the disinfection of water storage facilities. Prior to sampling, the chlorine residual must be reduced to normal system residual levels or be non-detectable in those systems not chlorinating. A minimum of two (2) samples must be collected and analyzed for total coliform bacteria. These samples must be collected at least twenty-four (24) hours apart and the results must show the absence of total coliform bacteria. The chlorine residual must also be measured and reported. If the membrane filter method of analysis is used for the coliform analysis, non-coliform growth must also be reported. If the non-coliform growth is greater than eighty (80) colonies per one hundred (100) ml, the sample result is invalid and must be repeated. All samples must be analyzed by a certified laboratory. The Department may request that heterotrophic plate count analyses be conducted on a case-by-case basis where disinfection problems are suspected.

(3) Washwater Tanks—Washwater tanks shall be designed in accordance with R.61-58.4(C)(1) and shall be sized, in conjunction with available pump units and finished water storage, to provide the backwash water required by R.61-58.3(D)(5)(a)(xi). Consideration must be given to the backwashing of several filters in rapid succession.

(4) Clearwell—

(a) Clearwell storage shall be sized, in conjunction with distribution system storage, to relieve the filters from having to follow fluctuations in water use.

(b) When finished water storage is used to provide the contact time for chlorine, special attention shall be given to size and baffling.

(c) An overflow shall be provided.

(d) Finished water must not be stored or conveyed in a compartment adjacent to unsafe water when the two compartments are separated by a single wall.

(5) Hydropneumatic (Pressure) tanks—Hydropneumatic (pressure) tanks, when provided as the only storage facility, are acceptable only in small water systems. For systems serving more than three hundred (300) taps or more than one thousand (1000) people, elevated storage shall be provided. Pressure tank storage shall not be considered for fire protection purposes, unless standby power is provided and the pumping capacity from wells or ground storage exceeds the fire flow demand with the largest well or pump out of service. Pressure tanks five hundred (500) gallons and larger shall meet the requirements of the American Society of Mechanical Engineers for the construction and installation of unfired pressure vessels and shall carry its approval stamp.

(a) The tank shall be located above normal ground surface and shall be fenced to protect it from vandalism.

(b) Sizing—For surface and ground water systems where the pump yield equals or exceeds the instantaneous demand, the tank shall be sized so the pump cycles a maximum of six (6) times per hour. Where the pump yield is less than the instantaneous demand the tank shall be sized to provide the difference for a minimum twenty (20) minute demand period based on the actual usable volume of the tank.

(c) Bypass Piping—A flow through arrangement is required for all hydropneumatic storage tanks. However, the tank shall also be equipped with bypass piping to permit the tank to be removed from service for repairs or painting without removing well(s) or booster pump(s) from service. Bypass piping is not required for tanks less than 500 gallons.

(d) Appurtenances—All hydropneumatic tanks shall be equipped with a drain, isolation valves, sample tap, pressure gauge, air make-up system (except for bladder tanks), pressure relief valve, and pressure operated start and stop controls for the pump. Each tank five hundred (500) gallons and larger shall have an access manhole, a minimum two (2) inch diameter drain, and a vacuum relief valve. An air compressor is required on tanks two thousand (2000) gallons and larger.

(e) Freezing—All hydropneumatic storage tanks and their appurtenances shall be designed to prevent freezing which will interfere with proper functioning.

(f) Painting and/or cathodic protection—Proper protection shall be given to metal surfaces by paints or other protective coatings, by cathodic protective devices, or by both. All paint coatings which come into contact with drinking water shall be certified as meeting the specifications of the American National Standard Institute/National Sanitation Foundation Standard 61, Drinking Water System Components—Health Effects. The certifying party shall be accredited by the American National Standards Institute. Hot applied wax, cold applied wax, grease, and coal tar coatings are not acceptable.

(g) Disinfection—Hydropneumatic storage tanks shall be disinfected in accordance with current American Waterworks Association (AWWA) Standard for the disinfection of water storage facilities. Prior to sampling, the chlorine residual must be reduced to normal system residual levels or be non-detectable in those systems not chlorinating. A minimum of two (2) samples must be collected and analyzed for total coliform bacteria. These samples must be collected at least twenty-four (24) hours apart and results must show the absence of total coliform bacteria. The chlorine residual must also be measured and reported. If the membrane filter method of analysis is used for the coliform analysis, non-coliform growth must also be reported. If the non-coliform growth is greater than eighty (80) colonies per one hundred (100) ml, the sample result is invalid and must be repeated. All samples must be analyzed by a certified laboratory. The Department may request that heterotrophic plate count analyses be conducted on a case-by-case basis where disinfection problems are suspected.

(h) The pressure range of hydropneumatic tanks shall not exceed twenty (20) pounds per square inch.

D. Distribution Systems.

(1) Materials Standards—Pipe, fittings, packing, jointing materials, valves and fire hydrants shall conform to Section C of the American Water Works Association (AWWA) Standards. All materials or products which come into contact with drinking water shall be certified as meeting the specifications of the American National Standard Institute/National Sanitation Foundation Standard 61, Drinking Water System Components—Health Effects. The certifying party shall be accredited by the American National Standards Institute. In the absence of American Water Works Association (AWWA) Standards, materials meeting applicable Product Standards and acceptable to the Department may be selected. SD 26 Class 160 and SD 21 Class 200 PVC pipe meeting ASTM Standard D1785 or D2241 are acceptable in sizes twelve (12) inches and smaller. Asbestos cement pipe shall not be used in potable water systems except in the repair of existing asbestos cement lines. Metallic pipe and fittings shall be lead free in accordance with R.61-58.4(F). Thermoplastic pipe shall not be used above grade.

(2) Used Materials—Water mains which have been used previously for conveying potable water may be reused provided they meet the above standards and have been thoroughly cleaned and restored practically to their original condition.

(3) Gaskets and Joints—Gaskets, O-rings, and other products used for jointing pipes, setting meters or valves, or other appurtenances which will expose the material to the water shall comply with the requirements of R.61-58.4(D)(1) and shall not be made of natural rubber or any other material which will support microbiological growth. Lubricants which will support microbiological growth shall not be used for slip-on joints. The use of vegetable shortening to lubricate joints is prohibited. The use of solvent-weld PVC pipe and fittings in water mains four (4) inches and larger is prohibited.

(4) Line Sizing—

(a) Pressure—The minimum pressure in all public water mains under conditions of maximum instantaneous demand shall be twenty-five (25) pounds per square inch at every customer's tap. Twenty (20) pounds per square inch will be acceptable at any tap when fire flows or flushing flows are provided in excess of maximum peak hourly flow.

(b) Diameter—The minimum size of water main for providing fire protection and serving fire hydrants shall be six (6) inches in diameter. Larger size mains will be required if necessary to allow the withdrawal of the required fire flow while maintaining the minimum residual pressure specified in R.61-58.4(D)(4)(a).

(5) No line extension shall be made of an existing line when the existing line does not meet the minimum pressure and flow requirements of this regulation.

(6) Dead ends—

(a) Dead ends shall be minimized by looping of all mains whenever practical.

(b) The lengths of small dead end lines shall not exceed the following:

- (i) One (1) inch diameter — 150 ft.
- (ii) One and one quarter (1 ¼) inch — 200 ft.
- (iii) One and one half (1 ½) inch — 300 ft.
- (iv) Two inches (2) — 1500 ft.

Conditions may warrant having less than the above maximum lengths in order to meet the twenty-five (25) pounds per square inch pressure requirement.

(7) Flushing—The design shall provide for a readily accessible means of flushing all water lines at a minimum velocity of 2.5 feet per second. This does not apply to service lines.

(a) Where dead-end lines occur they shall be provided with a fire hydrant if flow and pressure are sufficient, or with a post hydrant or readily accessible blow-off valve in a box for flushing purposes, except for the following cases:

- (i) Lines one and one half (1-1/2) inches in diameter and smaller will not require blow-offs. Two inch lines shorter than two hundred (200) feet will not require a blow-off. However, a service connection shall be installed at the end of the line or another acceptable means of bleeding chlorine through the lines must be provided.

(b) Blow-offs shall be sized to provide a minimum velocity of 2.5 feet per second in the line and maintain a residual pressure of twenty-five (25) pounds per square inch.

(c) Post-type hydrants are acceptable for flushing purposes on lines four (4) inch through eight (8) inch and can be used on three (3) inch lines where the design flow is increased to one hundred (100) gallons per minute in excess of peak hourly flow.

(d) Design head loss calculations, including elevation changes shall show twenty-five (25) pounds per square inch minimum residual when instantaneous demand occurs or twenty (20) pounds per square inch minimum residual when either fire flow or flushing flow in excess of peak hourly flow occurs, whichever is greater.

(e) Lines ten (10) inches and larger require flows in excess of five hundred (500) gallons per minute to achieve a two and a half (2.5) feet per second scouring velocity. This would require a standard fire hydrant or other approved blow-off, for flushing which must be designed to provide at least five hundred (500) gallons per minute in excess of peak hourly flow and a minimum residual pressure of twenty (20) pounds per square inch.

(f) No flushing device shall be directly connected to any sewer.

(8) Valves—Sufficient valves shall be provided on water mains so that customer inconvenience and sanitary hazards will be minimized during repairs.

(9) Hydrants—

(a) Where Standard four (4) to six (6) inch diameter hydrants are proposed, the design flow shall not be less than five hundred (500) gallons per minute over and above peak hourly flow. Standard hydrants shall not be placed on systems using only hydropneumatic storage, unless standby power is provided and the pumping capacity from wells or ground storage exceeds the fire flow demand with the largest well or pump out of service. Standard hydrants shall not be connected to lines not designed to carry fire flows.

(i) Hydrant Leads—The hydrant leads shall be a minimum of six (6) inches in diameter. Auxiliary gate valves shall be installed in all hydrant leads.

(ii) Drainage—A gravel pocket or dry well shall be provided unless the natural soils will provide adequate drainage. Hydrant drains shall not be connected to or located within ten (10) feet of sanitary sewers.

(b) Where Post-type hydrants are proposed, they must meet the flow requirements for blow-offs in R.61-58.4.D(7). Post hydrants shall not be used on lines smaller than three (3) inches. Design calculations must be submitted when utilizing post hydrants on three (3) inch lines. These calculations must show one hundred (100) gallons per minute in excess of peak hourly flow can be maintained, and provide a residual pressure greater than or equal to twenty (20) pounds per square inch.

(10) Air Relief Valves, Valve, Meter and Blow-Off Chambers

(a) Air relief valves—Air relief valves shall be provided in accordance with sound engineering practice at high points in water mains as required. Automatic air relief valves shall not be used in situations where flooding of the manhole or chamber may occur.

(b) Air relief valve piping—The open end of an air relief pipe from automatic valves or from a manually operated valve shall be extended to the top of the pit and provided with a screened downward facing elbow.

(c) Chamber drainage—Chambers, pits or manholes containing valves, blow-off, meters, air release valves, or other such appurtenances to a distribution system, shall not be connected directly to any storm drain or sanitary sewer.

(11) Installation of Mains—

(a) Standards—Construction specifications shall incorporate the provisions of Section C of the American Waterworks Association (AWWA) Standards and/or manufacturer's recommended installation procedures.

(b) Bedding—A continuous and uniform bedding shall be provided in the trench for all buried pipe. Back-fill material shall be tamped in layers around the pipe and to a sufficient height above

the pipe to adequately support and protect the pipe. Stones, other than crushed bedding, shall not come in contact with the pipe and shall not be within six (6) inches of the pipe..

(c) Cover—All water mains shall be provided with a minimum thirty (30) inches of cover. Where this is not possible, pipe shall be steel, concrete, ductile iron, or other approved material and method approved by the Department, and, when necessary, insulated to prevent freezing.

(d) Blocking—All tees, bends, plugs and hydrants on lines two and one half inches in diameter and larger shall be provided with reaction blocking, tie rods or other approved restraining methods to prevent movement.

(e) Pressure and leakage testing—All newly installed pipe shall be pressure tested and leakage tested in accordance with American Water Works Association (AWWA) Standard C600.

(f) Disinfection—Disinfection of all new water mains shall be in accordance with current American Water Works Association (AWWA) Standard C651 for the disinfection of water mains. In general one approved method referred to as “continuous feed method” is as follows: Before being placed in service, all new mains shall be thoroughly flushed then chlorinated with not less than twenty-five (25) milligrams per liter of available chlorine. Water from the existing distribution system or other source of supply shall be controlled so as to flow slowly into the newly laid pipeline during the application of chlorine. The solution shall be retained in the pipeline for not less than twenty-four (24) hours and then flushed thoroughly with a potable water of satisfactory bacteriological quality before starting the sampling program.

The contractor or owner shall collect a minimum of two (2) samples from each sampling site for total coliform analysis. The number of sites depends on the amount of new construction but must include all dead-end lines and be representative of the water in the newly constructed mains. Prior to sampling, the chlorine residual must be reduced to normal system residual levels or be non-detectable in those systems not chlorinating. These samples must be collected at least twenty-four (24) hours apart and must show the water line to be absent of total coliform bacteria. The chlorine residual must also be measured and reported. If the membrane filter method of analysis is used for the coliform analysis, non-coliform growth must also be reported. If the non-coliform growth is greater than eighty (80) colonies per one hundred (100) milliliters, the sample result is invalid and must be repeated. All samples must be analyzed by a certified laboratory. The Department may request that heterotrophic plate count analyses be conducted on a case-by-case basis where disinfection problems are suspected.

(g) Detection of mains—All mains shall be detectable within three (3) feet with electronic locating equipment. Non-metallic pipes shall be installed with copper wire or other means of detection.

(h) Contaminated Areas - All water mains shall be located out of all contaminated areas. If the main must run through a contaminated site, the main material must protect the water system from being contaminated (e.g. Ductile Iron Pipe with chemical resistant gaskets).

(12) Separation of Water Mains and Sewers—

(a) Parallel installation—Water mains shall be laid at least ten (10) feet horizontally from any existing or proposed sewer. The distance shall be measured edge to edge. In cases where it is not practical to maintain a ten foot separation, the Department may allow deviation on a case-by-case basis, if supported by data from the design engineer. Such deviation may allow installation of the water main closer to a sewer, provided that the water main is laid in a separate trench or on an undisturbed earth shelf located on one side of the sewer at such an elevation that the bottom of the water main is at least eighteen (18) inches above the top of the sewer.

(b) Crossings—Water mains crossing sewers shall be laid to provide a minimum vertical separation of eighteen (18) inches between the outside of the water main and the outside of the sewer. This shall be the case whether the water main is either above or below the sewer line. Whenever possible, the water main shall be located above the sewer line. Where a new water main crosses a new sewer line, a full length of pipe shall be used for both the water main and sewer line and the crossing shall be arranged so that the joints of each line will be as far as possible from the point of crossing and each other. Where a new water main crosses an existing sewer line, one full length of water pipe shall be located so both joints will be as far from the sewer line as possible.

Where a water main crosses under a sewer, adequate structural support shall be provided for the sewer line to prevent damage to the water main.

(c) Special Conditions—When it is impossible to obtain the distances specified in R.61-58.4(D)(12)(a) and (b) the Department may allow an alternative design. Any alternative design shall:

- (i) maximize the distances between the water main and sewer line and the joints of each;
- (ii) use materials which meet the requirements R.61-58.4(D)(1) for the sewer line; and,
- (iii) allow enough distance to make repairs to one of the lines without damaging the other.

(d) Force mains—There shall be at least a ten (10) foot horizontal separation between water mains and sanitary sewer force mains. There shall be an eighteen (18) inch vertical separation at crossing as required in R.61-58.4(D)(12)(a) and (b).

(e) Sewer manholes—No water pipe shall pass through or come in contact with any part of a sewer manhole. Water lines may come in contact with storm sewers or catch basins if there is no other practical alternative, provided that ductile iron is used, no joints of the water line are within the storm sewer or catch basin and the joints are located as far as possible from the storm sewer or catch basin.

(f) Drain-fields and Spray-fields—Potable water lines shall not be laid less than twenty-five (25) feet horizontally from any portion of a waste-water tile-field or spray-field, or shall be otherwise protected by an acceptable method approved by the Department.

(13) Surface Water Crossings—

(a) Above-water crossings—The pipe shall be adequately supported and anchored, protected from damage and freezing, and accessible for repair or replacement.

(b) Underwater crossings—A minimum cover of two (2) feet shall be provided over the pipe. When crossing water courses which are greater than fifteen (15) feet in width, the following shall be provided:

- (i) The pipe material and joints shall be designed appropriately;
- (ii) Valves shall be located so that the section can be isolated for testing or repair; the valves shall be easily accessible, and not subject to flooding; and,
- (iii) A blow-off shall be provided on the side opposite the supply service, sized in accordance with R.61-58.4(D)(7).
- (iv) Blow-offs shall not be directed toward creeks or other water bodies without proper precaution being taken to dechlorinate prior to discharge.

(14) Cross Connections and Interconnections—

(a) Cross connections—There shall be no connection between the distribution system and any pipes, pumps, hydrants, or tanks whereby unsafe water or other contamination materials may be discharged or drawn into the system.

(b) Cooling water—Neither steam condensate nor cooling water from engine jackets or other heat exchange devices shall be returned to the potable water supply.

(c) Interconnections—The approval of the Department shall be obtained for interconnections between potable water supplies.

(15) Water Services and Plumbing—

(a) Plumbing—Water services and plumbing shall conform to relevant local plumbing codes or to the National Plumbing Code.

(b) Booster pumps—Individual home booster pumps shall not be allowed to meet the twenty-five (25) pounds per square inch minimum pressure at the service connection.

(16) Water Loading Stations—To prevent contamination of the public supply, the following criteria shall be met:

- (a) Air Gap—A device shall be installed on the fill line to provide an air break and prevent a submerged discharge line.

(b) Hose length—The fill hose and cross connection control device must be constructed so that when hanging freely it will terminate at least two (2) feet above the ground surface.

(c) Fill line terminus—The discharge end of the fill line must be unthreaded and constructed to prevent the attachment of additional hose, piping or other appurtenances.

E. Public Buildings.

Water supply facilities in public buildings shall be designed to provide safe potable water to employees, customers, and guests.

(1) Source of Supply—

(a) Where a separate independent source is provided, it must be constructed in accordance with R.61-58.2 for groundwater systems or R.61-58.3 for surface water systems and treatment must be provided where necessary to meet the Water Quality Standards in R.61-58.5.

(b) Where an emergency or standby source is provided in addition to a service from a public water supply, it must be constructed in accordance with R.61-58.4(E)(1)(a) and maintained in operating condition. Where the main source of supply is from a public system, an approved double check assembly shall be installed after the meter in the main service line.

(c) Non-potable supplies shall not be connected to the potable water system.

(2) Quantity of Supply—

(a) The source of supply where service is provided from a public water system, shall be adequate to provide the instantaneous demand based on the number of fixtures to be provided.

(b) Where a separate source is provided, it must be designed to provide the maximum daily demand.

(3) On-Site Storage—

(a) On-site storage will be considered only where necessary to provide instantaneous demand or fire protection. In either case, the source of supply must be adequate to provide maximum daily demand.

(b) On-site storage, where used, must meet the requirements of R.61-58.4(C).

(4) Cross Connection Control—Public buildings shall be free of cross connections and be designed to meet applicable portions of R.61-58.7(F).

F. Lead Ban.

(1) Any pipe, solder, or flux which is used in the installation or repair of any public water system shall be lead free.

(2) Any pipe, solder, or flux which is used in any plumbing in a residential or nonresidential facility which provides water, through connection to a public water system, for human consumption shall be lead free.

(3) Lead free shall be defined, when used with respect to solders and flux, as those containing not more than two-tenths (0.2) percent lead.

(4) Lead free shall be defined, when used with respect to pipes and pipe fittings, as those containing not more than eight (8.0) percent lead.

(5) Leaded joints necessary for the repair of cast iron pipes shall be exempt from the lead free requirement.

(6) No person may import, manufacture, process, or distribute in commerce a new plumbing fitting or fixture, intended by the manufacturer to dispense water for human ingestion, that contains more than four (4) percent lead by dry weight.

G. Aquifer Storage and Recovery (ASR)—This section applies to the construction of new ASR wells and the modification of existing public water supply wells to allow its use as an ASR well.

(1) ASR Well Design, Construction, and Initial Development.

(a) All ASR wells must be designed, constructed and initially developed in accordance with all applicable sections of R.61-58.2.B.

(b) Underground Injection Control (UIC) Construction Permit: An UIC construction permit pursuant to State Regulation R.61-87 is required for all ASR wells.

(c) Preliminary Engineering Report (PER): A PER must be submitted and reviewed by the Department for all ASR wells in accordance with applicable portions of R.61-58.1.C prior to submission of the construction application.

(d) ASR Wellhead Piping must meet the following minimum requirements:

(i) A properly sized injection line must be provided.

(ii) The injection by-pass line, or main wellhead piping, must be provided with a means of recording instantaneous and totalized flows both in and out of the well.

(iii) A properly placed check valve must be provided in the injection by-pass line.

(iv) A means must be provided to manually isolate the injection line.

(v) Calculations must be provided to show the system can maintain pressure requirements at all services taps during injection.

(2) ASR Water Treatment: All ASR water treatment must be in accordance with all applicable portions of R.61-58.2.D. In addition, all water withdrawn from ASR wells must be properly disinfected in accordance with all applicable requirements of its source water (i.e., groundwater or surface water).

(3) ASR Well Final Development. An UIC permit for the operation of an ASR well must be obtained in accordance with R.61-87.

(a) Well Development Report: A well development report must be submitted and reviewed by the Department under R.61-87 which outlines the findings of the final ASR well development (e.g., injection and withdrawal rates, cycle testing, water quality data).

(b) Location of Discharge: All pumping discharge must be done in accordance with R.61-58.2.B(12)(c).

HISTORY: Amended by State Register Volume 19, Issue No. 7, eff July 28, 1995; State Register Volume 25, Issue No. 9, eff Sept. 28, 2001; State Register Volume 26, Issue No. 5, Part 1, eff May 24, 2002.

61-58.5. Maximum Contaminant Levels in Drinking Water.

Table of Contents

- A. Applicability
- B. Maximum Contaminant Levels for Inorganic Chemicals
- C. Primary Inorganic Chemical Sampling and Analytical Requirements
- D. Maximum Contaminant Levels for Organic Chemicals
- E. Organic Chemicals Other Than Total Trihalomethanes, Sampling and Analytical Requirements
- F. Maximum Contaminant Levels (MCLs) for Microbiological Contaminants
- G. Microbiological Contaminant Sampling and Analytical Requirements
- H. Maximum Contaminant Levels for Radionuclides
- I. Monitoring Frequency and Compliance Requirements for Radionuclides in Community Water Systems
- J. Maximum Contaminant Level Goals for Radionuclides
- K. Analytical Methods for Radionuclides
- L. Maximum Contaminant Levels for Total Trihalomethane Concentration
- M. Total Trihalomethane Sampling, Analytical and Other Requirements
- N. Maximum Contaminant Levels for Volatile Synthetic Organic Chemicals (VOCs)
- O. VOC Monitoring, Sampling and Analytical Requirements
- P. Maximum Contaminant Levels for Disinfection Byproducts
- Q. Maximum Residual Disinfectant Levels (MRDLs) for Disinfectants
- R. Secondary Maximum Contaminant Levels
- S. Secondary Maximum Contaminant Levels Sampling and Analytical Requirements

- T. Special Monitoring for Inorganic and Organic Contaminants
- U. Special Monitoring for Sodium
- V. Special Monitoring for Corrosivity Characteristics
- W. Special Monitoring and Notification Requirements
- X. Monitoring of Consecutive Public Water Systems
- Y. Criteria and Procedures for Public Water Systems using Point-of-Entry Devices
- Z. Use of Other Non-Centralized Treatment Devices
- AA. Treatment Techniques
- BB. Approved Laboratories
- CC. Alternative Analytical Techniques
- DD. and EE. [Deleted]

A. Applicability.

This regulation shall apply to each public water system, unless the water system meets all of the following conditions:

- (1) Consists only of distribution and storage facilities (and does not have any collection and treatment facilities);
- (2) Obtains all of its water from, but is not owned or operated by, a public water system to which such regulations apply;
- (3) Does not sell water to any person; and
- (4) Is not a carrier which conveys passengers in interstate commerce.

B. Maximum Contaminant Levels for Inorganic Chemicals

(1) The Maximum Contaminant Levels (MCLs) for inorganic contaminants specified in R.61-68.5(B)(2) shall apply to all public water systems. Compliance with maximum contaminant levels for inorganic chemicals are calculated pursuant to Section (C) below:

(2) The maximum contaminant levels for inorganic chemicals are as follows:

<u>Contaminant</u>	<u>Level(mg/l)</u>
(a) Arsenic	0.010 **
(b) Asbestos	7 Million Fibers/liter (longer than 10/μm)
(c) Barium	2.0
(d) Cadmium	0.005
(e) Chromium	0.1
(f) Fluoride	4.0
(g) Mercury	0.002
(h) Nitrate (as Nitrogen)	10
(i) Nitrite (as Nitrogen)	1
(j) Total Nitrate and Nitrite (as Nitrogen)	10
(k) Selenium	0.05
(l) Antimony	0.006
(m) Beryllium	0.004
(n) Cyanide (as free Cyanide)	0.2
(o) Thallium	0.002

** The MCL for arsenic is 0.05 milligrams per liter (mg/l) for all public water systems until January 23, 2006.

(3) At the discretion of the Department, nitrate levels not to exceed twenty milligrams per liter may be allowed in a non-community water system if the supplier of water demonstrates to the satisfaction of the Department that:

- (a) Such water will not be available to children under six months of age; and,

(b) The non-community water system is meeting the public notification requirements under R.61-58.6.E(9), including continuous posting of the fact that nitrate levels exceed ten milligrams per liter and the potential health effects of exposure; and,

(c) No adverse health effects shall result from the consumption of this water.

C. Primary Inorganic Chemical Sampling and Analytical Requirements

(1) The monitoring requirements for inorganic contaminants specified in Section B (2)(b), (c), (d), (e), (g), (k), (l), (m), (n), and (o) above apply to community water systems and non-transient non-community water systems. The monitoring requirements for inorganic contaminants specified in Section B (2)(a) and (f) above only apply to community water systems. Beginning January 22, 2004, the monitoring requirements for the inorganic contaminant specified in Section B (2)(a) above will apply to community water systems and non-transient, non-community water systems. The monitoring required for inorganic contaminants specified in Section B (2)(h), (i) and (j) above apply to community, non-transient non-community and transient non-community water systems.

(2) Analytical methods used to comply with Section B above, shall be made using EPA-approved methods listed in 40 CFR 141. Analyses for the purpose of determining compliance with Section B above are required as follows:

(a) Analyses for all community water systems utilizing surface water sources, in whole or in part, shall be completed within one year following the effective date of this regulation. These analyses shall be repeated at yearly intervals.

(b) Analyses for all community water systems utilizing only groundwater sources shall be completed within two years following the effective date of this regulation. These analyses shall be repeated at three-year intervals.

(c) For non-community water systems, whether supplied by surface or groundwater sources, analyses for nitrate shall be completed within two years following the effective date of this regulation. These analyses shall be repeated at intervals determined by the Department.

(d) The Department shall have the authority to determine compliance or to initiate enforcement action based upon analytical results and other information compiled by the Department.

(3) If the result of an analysis made pursuant to subsection (2) above indicates that the level of any contaminant listed in Section B above exceeds the maximum contaminant level, the supplier of water shall report to the Department within seven days.

(4) When the maximum contaminant level for any contaminant listed in Section B above is exceeded as determined in accordance with subsection (15) below, the supplier of water shall notify the Department and give notice to the public pursuant to R. 61-58.6, Reports, Record Retention, and Public Notification, Sections B and E. Monitoring after public notification shall be at a frequency designated by the Department and shall continue until the maximum contaminant level has not been exceeded in two successive samples or until a monitoring schedule as a condition to a variance, exemption, or enforcement action shall become effective.

(5) The provisions of subsections (3) and (4) above notwithstanding, compliance with the maximum contaminant level for nitrate and nitrite shall be determined in accordance with subsection (12)(b) below.

(6) For the initial analyses required by items (2)(a), (b), or (c) above, data for surface waters acquired within one year prior to the effective date and data for groundwaters acquired within three years prior to the effective date of this regulation may be substituted at the discretion of the Department. Analyses conducted to determine compliance with Section B above shall be made in accordance with the analytical methods adopted by the Department.

(7) Monitoring for the purpose of determining compliance with the maximum contaminant levels specified in Section B (2) above, shall be conducted as follows:

(a) Groundwater systems shall take a minimum of one sample at every entry point to the distribution system which is representative of each well after treatment (hereafter called a sampling point) beginning in the initial compliance period. The system shall take each sample at the same sampling point unless conditions make another sampling point more representative of each source or treatment plant.

(b) Surface water systems shall take a minimum of one sample at every entry point to the distribution system after any application of treatment or in the distribution system at a point which is representative of each source after treatment (hereafter called a sampling point) beginning in the initial compliance period. The system shall take each sample at the same sampling point unless conditions make another sampling point more representative of each source or treatment plant. [Note: For purposes of this paragraph, surface water systems include systems with a combination of surface and ground sources.]

(c) If a system draws water from more than one source and the sources are combined before distribution, the system must sample at an entry point to the distribution system during periods of normal operating conditions (i.e., when water is representative of all sources being used).

(d) The Department may reduce the total number of samples which must be analyzed by allowing the use of compositing. Composite samples from a maximum of five samples are allowed, provided that the detection limit of the method used for analysis is less than one-fifth of the MCL. Compositing of samples must be done in the laboratory.

(i) If the concentration in the composite sample is greater than or equal to one-fifth of the MCL of any inorganic chemical, then a follow-up sample must be taken within 14 days at each sampling point included in the composite. These samples must be analyzed for the contaminants which exceeded one-fifth of the MCL in the composite sample. Detection limits for each analytical method and inorganic contaminant shall be in accordance with those listed in 40 CFR 141.

DETECTION LIMITS FOR INORGANIC CONTAMINANTS

Contaminant	MCL(mg/l)	Methodology	Detection Limit(mg/l)
Antimony	0.006	Atomic Absorption; Furnace	0.003
		Atomic Absorption; Platform	0.00086
		ICP-Mass Spectrometry	0.0004
		Hydride-Atomic Absorption	0.001
Asbestos	7 MFL ²	Transmission Electron Microscopy	0.01 MFL
Barium	2	Atomic Absorption; furnace technique	0.002
		Atomic Absorption; direct aspiration	0.1
		Inductively Coupled Plasma	0.002(0.001) ¹
Beryllium	0.004	Atomic Absorption; Furnace	0.0002
		Atomic Absorption; Platform	0.00002 ⁶
		Inductively Coupled Plasma ³	0.0003
		ICP-Mass Spectrometry	0.0003
Cadmium	0.005	Atomic Absorption; furnace technique	0.0001
		Inductively Coupled Plasma	0.001 ¹
Chromium	0.1	Atomic Absorption; furnace technique	0.001
		Inductively Coupled Plasma	0.007(0.001) ¹
Cyanide	0.2	Distillation, Spectrophotometric ⁴	0.02
		Distillation, Automated, Spectrophotometric ⁴	0.005
		Distillation, Selective Electrode ⁴	0.05
		Distillation, Amenable, Spectrophotometric ⁵	0.02
Mercury	0.002	Manual Cold Vapor Technique	0.0002
		Automated Cold Vapor Technique	0.0002
Nickel	0.1	Atomic Absorption; Furnace	0.001
		Atomic Absorption; Platform	0.0006 ⁵
		Inductively Coupled Plasma ³	0.005

Contaminant	MCL(mg/l)	Methodology	Detection Limit(mg/l)
		ICP-Mass Spectrometry	0.0005
Nitrate	10(as N)	Manual Cadmium Reduction	0.01
		Automated Hydrazine Reduction	0.01
		Automated Cadmium Reduction	0.05
		Ion Selective Electrode	1
		Ion Chromatography	0.01
Nitrite	1(as N)	Spectrophotometric	0.01
		Automated Cadmium Reduction	0.05
		Manual Cadmium Reduction	0.01
		Ion Chromatography	0.004
Selenium	0.05	Atomic Absorption; furnace	0.002
		Atomic Absorption; gaseous hydride	0.002
Thallium	0.002	Atomic Absorption; Furnace	0.001
		Atomic Absorption; Platform	0.0007 ⁶
		ICP-Mass Spectrometry	0.0003

¹ MFL = million fibers per liter > 10µm.

² Using a 2X preconcentration step as noted in method 200.7. Lower MDLs may be achieved when using a 4X preconcentration.

³ Screening method for total cyanides.

⁴ Measures “free” cyanides.

⁵ Lower MDLs are reported using stabilized temperature graphite furnace atomic absorption.

(ii) If the population served by the system is greater than 3,300 persons, then compositing may only be permitted by the Department at sampling points within a single system. In systems serving 3,300 persons or less, the Department may permit compositing among different systems provided the 5-sample limit is maintained.

(iii) If duplicates of the original sample taken from each sampling point used in the composite are available, the system may use these instead of resampling. The duplicates must be analyzed and the results reported to the Department within 14 days of collection.

(e) The frequency of monitoring for asbestos shall be in accordance with paragraph (8) of this section; the frequency of monitoring for antimony, arsenic, barium, beryllium, cadmium, chromium, cyanide, fluoride, mercury, nickel, selenium and thallium shall be in accordance with paragraph (9) of this section; the frequency of monitoring for nitrate shall be in accordance with paragraph (10) of this section; and the frequency of monitoring for nitrite shall be in accordance with paragraph (11) of this section.

(8) The frequency of monitoring conducted to determine compliance with the maximum contaminant level for asbestos specified in Section B(2) above shall be conducted as follows:

(a) Each community and non-transient, non-community water system is required to monitor for asbestos during the first three-year compliance period of each nine-year compliance cycle beginning in the compliance period starting January 1, 1993.

(b) If the system believes it is not vulnerable to either asbestos contamination in its source water or due to corrosion of asbestos-cement pipe, or both, it may apply to the Department for a waiver of the monitoring requirement in paragraph (8)(a) of this section. If the Department grants the waiver, the system is not required to monitor.

(c) The Department may grant a waiver based on a consideration of the following factors:

(i) Potential asbestos contamination of the water source; and,

(ii) The use of asbestos-cement pipe for finished water distribution and the corrosive nature of the water.

(d) A waiver remains in effect until the completion of the three-year compliance period. Systems not receiving a waiver must monitor in accordance with the provisions of paragraph (8)(a) of this section.

(e) A system vulnerable to asbestos contamination due solely to corrosion of asbestos-cement pipe shall take one sample at a tap served by asbestos-cement pipe and under conditions where asbestos contamination is most likely to occur.

(f) A system vulnerable to asbestos contamination due solely to source water shall monitor in accordance with the provision of paragraph (7) of this section.

(g) A system vulnerable to asbestos contamination due both to its source water supply and corrosion of asbestos-cement pipe shall take one sample at a tap served by asbestos-cement pipe and under conditions where asbestos contamination is most likely to occur.

(h) A system which exceeds the maximum contaminant levels as determined in paragraph (15) of this section shall monitor quarterly beginning in the next quarter after the violation occurred.

(i) The Department may decrease the quarterly monitoring requirement to the frequency specified in paragraph (8)(a) of this section provided the Department has determined that the system is reliably and consistently below the maximum contaminant level. In no case can the Department make this determination unless a groundwater system takes a minimum of two quarterly samples and a surface (or combined surface/ground) water system takes a minimum of four quarterly samples.

(j) If monitoring data collected after January 1, 1990 are generally consistent with the requirements of paragraph (8) of this section, then the Department may allow systems to use that data to satisfy the monitoring requirement for the initial compliance period beginning January 1, 1993.

(9) The frequency of monitoring conducted to determine compliance with the maximum contaminant levels in Section B(2) above for antimony, arsenic, barium, beryllium, cadmium, chromium, cyanide, fluoride, mercury, nickel, selenium, and thallium shall be as follows:

(a) Groundwater systems shall take one sample at each sampling point beginning in the compliance period starting January 1, 1993 during each compliance period. Surface water systems (or combined surface/ground) shall take one sample annually at each sampling point.

(b) The system may apply to the Department for a waiver from the monitoring frequencies specified in paragraph (9)(a) of this section. The Department may grant a public water system a waiver for monitoring of cyanide, provided that the Department determines that the system is not vulnerable due to lack of any industrial source of cyanide.

(c) A condition of the waiver shall require that a system shall take a minimum of one sample while the waiver is effective. The term during which the waiver is effective shall not exceed one compliance cycle (i.e., nine years).

(d) The Department may grant a waiver provided surface water systems have monitored annually for at least three years and groundwater systems have conducted a minimum of three rounds of monitoring. (At least one sample shall have been taken since January 1, 1990.) Both surface and groundwater systems shall demonstrate that all previous analytical results were less than the maximum contaminant level. Systems that use a new water source are not eligible for a waiver until three rounds of monitoring from the new source have been completed.

(e) In determining the appropriate reduced monitoring frequency, the Department shall consider:

(i) Reported concentrations from all previous monitoring;

(ii) The degree of variation in reported concentrations; and

(iii) Other factors which may affect contaminant concentrations such as changes in groundwater pumping rates, changes in the system's configuration, changes in the system's operating procedures, or changes in stream flows or characteristics.

(f) A decision by the Department to grant a waiver shall be made in writing and shall set forth the basis for the determination. The determination may be initiated by the Department or upon an application by the public water system. The public water system shall specify the basis for its request. The Department shall review and, where appropriate, revise its determination of the appropriate monitoring frequency when the system submits new monitoring data or when other data relevant to the system's appropriate monitoring frequency become available.

(g) Systems which exceed the maximum contaminant levels as calculated in paragraph (15) of this section shall monitor quarterly beginning in the next quarter after the violation occurred.

(h) The Department may decrease the quarterly monitoring requirement to the frequencies specified in paragraphs (9)(a) and (9)(c) of this section provided it has determined that the system is reliably and consistently below the maximum contaminant level. In no case can the Department make this determination unless a groundwater system takes a minimum of two quarterly samples and a surface water system takes a minimum of four quarterly samples.

(i) All new systems or systems that use a new source of water that begin operation after January 22, 2004 must demonstrate compliance with the MCL within a period of time specified by the Department. The system must also comply with the initial sampling frequencies specified by the Department to ensure a system can demonstrate compliance with the MCL. Routine and increased monitoring frequencies shall be conducted in accordance with the requirements in this section.

(10) All public water systems (community; non-transient, non-community; and transient, non-community) shall monitor to determine compliance with the maximum contaminant level for nitrate in Section B above.

(a) Community and non-transient, non-community water systems served by groundwater systems shall monitor annually beginning January 1, 1993; systems served by surface water shall monitor quarterly beginning January 1, 1993.

(b) For community and non-transient, non-community water systems, the repeat monitoring frequency for ground water systems shall be quarterly for at least one year following any one sample in which the concentration is less than 50 percent of the MCL. The Department may allow a groundwater system to reduce the sampling frequency to annually after four consecutive quarterly samples are reliably and consistently less than the MCL.

(c) For community and non-transient, non-community water systems, the Department may allow a surface water system to reduce the sampling frequency to annually if all analytical results from four consecutive quarters are <50 percent of the MCL. A surface water system shall return to quarterly monitoring if any one sample is \geq 50 percent of the MCL.

(d) Each transient non-community water system shall monitor annually beginning January 1, 1993.

(e) After the initial round of quarterly sampling is completed, each community and non-transient non-community system which is monitoring annually shall take subsequent samples during the quarter(s) which previously resulted in the highest analytical result.

(11) All public water systems (community; non-transient, non-community; and transient, non-community systems) shall monitor to determine compliance with the maximum contaminant level for nitrite in Section B above.

(a) All public water systems shall take one sample at each sampling point in the compliance period beginning January 1, 1993 and ending December 31, 1995.

(b) After the initial sample, systems where an analytical result for nitrite is less than 50 percent of the MCL shall monitor at the frequency specified by the Department.

(c) For community and non-transient, non-community water systems, the Department may allow a surface water system to reduce the sampling frequency to annually if all analytical results from four consecutive quarters are less than 50 percent of the MCL. A surface water system shall return to quarterly monitoring if any one sample is 50 percent or more of the MCL.

(d) Systems which are monitoring annually shall take each subsequent sample during the quarter(s) which previously resulted in the highest analytical result.

(12) Confirmation samples:

(a) Where the results of sampling for asbestos, antimony, arsenic, barium, beryllium, cadmium, chromium, cyanide, fluoride, mercury, nickel, selenium or thallium indicate an exceedance of the maximum contaminant level, the Department may require that one additional sample be collected as soon as possible after the initial sample was taken (but not to exceed two weeks) at the same sampling point.

(b) Where nitrate or nitrite sampling results indicate an exceedance of the maximum contaminant level, the system shall take a confirmation sample within twenty-four (24) hours of the system's receipt of notification of the analytical results of the first sample. Systems unable to comply with the twenty (24) hour sampling requirement must immediately notify the consumers served by the area served by the public water system in accordance with R.61-58.6.B and E and meet other Tier 1 public notification requirements under this regulation. Systems exercising this option must take and analyze a confirmation sample within two weeks of notification of the analytical results of the first sample.

(c) If a Department-required confirmation sample is taken for any contaminant, then the results of the initial and confirmation sample shall be averaged. The resulting average shall be used to determine the system's compliance in accordance with paragraph (15) of this section. The Department has the discretion to delete results of obvious sampling errors.

(13) The Department may require more frequent monitoring than specified in paragraphs (8), (9), (10) and (11) of this section or may require confirmation samples for positive and negative results at its discretion.

(14) Systems may apply to the Department to conduct more frequent monitoring than the minimum monitoring frequencies specified in this section.

(15) Compliance with Section B(2) above (as appropriate) shall be determined based on the analytical result(s) obtained at each sampling point.

(a) For systems which are conducting monitoring at a frequency greater than annual, compliance with the maximum contaminant levels for antimony, arsenic, asbestos, barium, beryllium, cadmium, chromium, cyanide, fluoride, mercury, nickel, selenium, or thallium is determined by a running annual average at any sampling point. If the average at any sampling point is greater than the MCL, then the system is out of compliance. If any one sample would cause the annual average to be exceeded, then the system is out of compliance immediately. Any sample below the method detection limit shall be calculated at zero for the purpose of determining the annual average. If a system fails to collect the required number of samples, compliance (average concentration) will be based on the total number of samples collected.

(b) For systems which are monitoring annually, or less frequently, the system is out of compliance with the maximum contaminant levels for arsenic, asbestos, antimony, barium, beryllium, cadmium, chromium, cyanide, fluoride, mercury nickel, selenium or thallium if the level of a contaminant at any sampling point is greater than the MCL. If a confirmation sample is required by the Department, the determination of compliance will be based on the average of the two samples.

(c) Compliance with the maximum contaminant levels for nitrate and nitrite is determined based on one sample if the levels of these contaminants is below the MCLs. If the levels of nitrate and/or nitrite exceed the MCLs in the initial sample, a confirmation sample is required in accordance with paragraph (12)(b) of this section, and compliance shall be determined based on the average of the initial and confirmation samples.

(d) Arsenic sampling results will be reported to the nearest 0.001 mg/L.

(16) Each public water system shall monitor at the time designated by the Department during each compliance period.

(17) Inorganic analysis:

(a) Analysis for antimony, arsenic, barium, beryllium, cadmium, chromium, cyanide, fluoride, mercury, nickel, nitrate, nitrite, selenium, and thallium shall be conducted using EPA-approved methods listed in 40 CFR 141.

INORGANIC CONTAMINANTS ANALYTICAL METHODS

Contaminant	Methodology	Reference (Method Number)		SM ³	USGS ⁴	Other
		EPA	ASTM ²			
Antimony	Atomic Absorption; Furnace ⁶	204.21		3113		
	Atomic Absorption; Platform ⁶	200.9 ⁶				
	ICP-Mass Spectrometry ⁶	200.8 ⁶				
	Hydride-Atomic Absorption ⁹		D-3697-87			

Contaminant	Methodology	Reference (Method Number)		SM3	USGS ⁴	Other
		EPA	ASTM ²			
Asbestos	Transmission Electron Microscopy	EPA ¹²				
Barium	Atomic Absorption; Furnace ⁶	208.21		3113B		
	Atomic Absorption; Direct ⁶	208.11		3111D		
	Inductively Coupled Plasma ⁶	200.76		3120		
Beryllium	Atomic Absorption; Furnace ⁶	210.21	D-3645-84B	3113		
	Atomic Absorption; Platform ⁶	200.96				
	Inductively Coupled Plasma ⁶	200.76		3120		
	ICP-Mass Spectrometry ⁶	200.86				
Cadmium	Atomic Absorption; Furnace ⁶	213.21		3113B		
	Inductively Coupled Plasma ⁶	200.76				
Chromium	Atomic Absorption; Furnace ⁶	218.21		3113B		
	Inductively Coupled Plasma ⁶	200.76		3120		
Cyanide	Distillation, Spec.	335.21	D-2036-89A	4500-CN-D	1330085	
	Distillation, Automated, Spec.	335.31		4500-CN-E		
	Distillation, Selective Electrode		D-2036-89A	4500-CN-F		
	Distillation, Amenable, Spec.	335.11	D-2036-89B	4500-CN-G		
Mercury	Manual Cold Vapor Technique ⁹	245.11	D3223-86	3112B		
	Automated Cold Vapor Technique ⁹	245.21				
Nickel	Atomic Absorption; Furnace ⁶	249.21		3113		
	Atomic Absorption; Platform ⁶	200.96				
	Atomic Absorption; Direct ⁶	249.11		3111B		
	Inductively Coupled Plasma ⁶	200.76		3120		
	ICP-Mass Spectrometry ⁶	200.86				
Nitrate	Manual Cadmium Reduction	353.31	D3867-90	4500-NO ₃ -E		
	Automated Hydrazine Reduction	353.11				
	Automated Cadmium Reduction	353.21	D3867-90	4500-NO ₃ -F		
	Ion Selective Electrode				WeWWG/5880 ⁷	
	Ion Chromatograph	300.011				B-1011 ⁸
Nitrite	Spectrophotometric	354.11				
	Automated Cadmium Reduction	353.21	D3867-90	4500-NO ₃ -F		
	Manual Cadmium Reduction	353.31	D3867-90	4500-NO ₃ -E		
	Ion Chromatography	300.011				B-1011 ⁸
Selenium	Hydride-Atomic Absorption ⁹		D3859-84A	3114B		
	Atomic Absorption; Furnace ⁶ 10	270.21	D3959-88	3113B		
Thallium	Atomic Absorption; Furnace ⁶	279.21		3113		
	Atomic Absorption; Platform ⁶	200.95				
	ICP-Mass Spectrometry ⁶	200.85				

¹ "Methods of Chemical Analysis of Water and Wastes," EPA Environmental Monitoring Systems Laboratory, Cincinnati, OH 45268 March 1983. EPA-600/4-79-020.

² Annual Book of ASTM Standards, Vols. 11.01 and 11.02, 1991. American Society of Testing and Materials, 1916 Race Street, Philadelphia, PA 19103.

³ "Standard Methods for the Examination of Water and Wastewater," 17th edition, American Public Health Association, American Water Works Association. Water Pollution Control Federation, 1989.

⁴ Techniques of Water Resources Investigations of the U.S. Geological Survey, "Methods for Determination of Inorganic Substances in Water and Fluvial Sediments," Book 5, Chapter A-1, Third edition, 1989. Available at Superintendent of Documents, U.S. Government Printing Office, Washington, DC 20402.

⁵ "Methods for Determination of Metals in Environmental Samples." Available at NTIS, PB 91-231498.

⁶ Samples that contain less than 1 NTU (nephelometric turbidity unit) and are properly preserved (conc HNO₃ to pH < 2) may be analyzed directly (without digestion) for total metals, otherwise, digestion is required. Turbidity must be measured on the preserved samples just prior to initiation of metal analysis. When digestion is required, the total recoverable technique as defined in the method must be used.

⁷ "Orion Guide to Water and Wastewater Analysis." For WeWWG/5880, p.5, 1985. Orion Research, Inc., Cambridge, MA.

⁸ "Waters Test Method for Determination of Nitrite/Nitrate in Water Using Single Column Ion Chromatography, Method B-1011. Millipore Corporation, Waters Chromatography Division, 34 Maple Street, Milford, MA 01757.

⁹ For the gaseous hydride determinations of antimony and selenium and for the determination of mercury by the cold vapor techniques, the proper digestion technique as defined in the method must be followed to ensure the element is in the proper state for analyses.

¹⁰ Add 2 ml of 30% H₂O₂ and an appropriate concentration of matrix modifier Ni(NO₂) + 6H₂O (nickel nitrate) to samples.

¹¹ "Method 300. Determination of Inorganic Anions in Water by Ion Chromatography." Inorganic Chemistry Branch, Environmental Monitoring Systems Laboratory. August 1991.

¹² "Analytical Method for Determination of Asbestos Fibers in Water," EPA-600/4-83-043, September 1983, U.S. EPA Environmental Research Laboratory, Athens, GA 30613.

(b) Sample collection for antimony, arsenic, asbestos, barium, beryllium, cadmium, chromium, cyanide, fluoride, mercury, nickel, nitrate, nitrite, selenium, and thallium under this section shall be conducted using EPA-approved methods listed in 40 CFR 141.

(c) Analysis under this section shall only be conducted by laboratories that have been certified by the Department.

D. Maximum Contaminant Levels for Organic Chemicals

(1) The following are the maximum contaminant levels for organic chemicals. The MCLs specified in R.61-58.5(D)(2) below, apply to all public water systems. The maximum contaminant level for total trihalomethanes is pursuant to Section P below.

(2) The maximum contaminant levels for organic chemicals are as follows:

	Contaminant	Level, mg/l
(a)	Reserved	
(b)	(i) Alachlor	0.002
	(ii) Atrazine	0.003
	(iii) Carbofuran	0.04
	(iv) Chlordane	0.002
	(v) Dibromochloropropane	0.0002
	(vi) 2,4-D	0.07
	(vii) Ethylene dibromide (EDB)	0.00005
	(viii) Heptachlor	0.0004
	(ix) Heptachlor epoxide	0.0002
	(x) Lindane	0.0002
	(xi) Methoxychlor	0.04
	(xii) Polychlorinated biphenyls(PCBs)	0.0005
	(xiii) Pentachlorophenol	0.001
	(xiv) Toxaphene	0.003
	(xv) 2,4,5-TP	0.05
	(xvi) Benzo[a]pyrene	0.0002
	(xvii) Dalapon	0.2
	(xviii) Di(2-ethylhexyl)adipate	0.4
	(xvix) Di(2-ethylhexyl)phthalate	0.006
	(xx) Dinoseb	0.007
	(xxi) Diquat	0.02
	(xxii) Endothall	0.1
	(xxiii) Endrin	0.002
	(xxiv) Glyphosate	0.7
	(xxv) Hexachlorobenzene	0.001
	(xxvi) Hexachlorocyclopentadiene	0.05
	(xxvii) Oxamyl (vydate)	0.2
	(xxviii) Picloram	0.5
	(xxvix) Simazine	0.004
	(xxx) 2,3,7,8-TCDD (Dioxin)	3 X 10 ⁻⁸

E. Organic Chemicals Other Than Total Trihalomethanes, Sampling and Analytical Requirements

(1) The monitoring requirements for organic contaminants specified in R.61-58.5(D)(2)(a) shall apply to all community water systems. The monitoring requirements for organic contaminants specified in 61-58.5(D)(2)(b) shall apply to community water systems and non-transient non-community water systems.

(2) [Reserved]

(3) [Reserved]

(4) [Reserved]

(5) [Reserved]

(6) [Reserved]

(7) Analytical methods used to comply with Section D(2)(b) above, shall be made using EPA-approved methods listed in 40 CFR 141. Analysis of the contaminants listed in Section D(2)(b) above, for the purposes of determining compliance with the maximum contaminant level shall be conducted as follows:

(a) Groundwater systems shall take a minimum of one sample at every entry point to the distribution system which is representative of each well after treatment (hereafter called a sampling point). Each sample must be taken at the same sampling point unless conditions make another sampling point more representative of each source or treatment plant.

(b) Surface water systems shall take a minimum of one sample at points in the distribution system that are representative of each source or at each entry point to the distribution system after treatment (hereafter called a sampling point). Each sample must be taken at the same sampling point unless conditions make another sampling point more representative of each source or treatment plant. [Note: For purposes of this paragraph, surface water systems include systems with a combination of surface and ground sources.]

(c) If the system draws water from more than one source and the sources are combined before distribution, the system must sample at an entry point to the distribution system during periods of normal operating conditions (i.e., when water representative of all sources is being used).

(d) Monitoring frequency:

(i) Each community and non-transient non-community water system shall take four consecutive quarterly samples for each contaminant listed in Section D(2)(b) above, during each compliance period beginning with the initial compliance period.

(ii) Systems serving more than 3,300 persons which do not detect a contaminant in the initial compliance period, may reduce the sampling frequency to a minimum of two quarterly samples in one year during each repeat compliance period.

(iii) Systems serving 3,300 persons or less which do not detect a contaminant in the initial compliance period may reduce the sampling frequency to a minimum of one sample during each repeat compliance period.

(e) Each community and non-transient water system may apply to the Department for a waiver from the requirement of paragraph (7)(d) of this section. A system must reapply for a waiver for each compliance period.

(f) The Department may grant a waiver after evaluating the following factor(s): Knowledge of previous use (including transport, storage, or disposal) of the contaminant within the watershed or zone of influence of the system. If a determination by the Department reveals no previous use of the contaminant within the watershed or zone of influence, a waiver may be granted. If previous use of the contaminant is unknown or it has been used previously, then the following factors shall be used to determine whether a waiver is granted.

(i) Previous analytical results.

(ii) The proximity of the system to a potential point or non-point source of contamination. Point sources include spills and leaks of chemicals at or near a water treatment facility or at manufacturing, distribution, or storage facilities, or from hazardous and municipal waste landfills and other waste handling or treatment facilities. Non-point sources include the use of pesticides to control insect and weed pests on agricultural areas, forest lands, home and gardens, and other land application uses.

(iii) The environmental persistence and transport of the pesticide or PCBs.

(iv) How well the water source is protected against contamination due to such factors as depth of the well and the type of soil and the integrity of the well casing.

- (v) Elevated nitrate levels at the water supply source.
- (vi) Use of PCBs in equipment used in the production, storage, or distribution of water (i.e., PCBs used in pumps, transformers, etc.).
- (g) If an organic contaminant listed in Section D(2)(b) above, is detected (as defined by paragraph (7)(r) of this section) in any sample, then:
 - (i) Each system must monitor quarterly at each sampling point which resulted in a detection.
 - (ii) The Department may decrease the quarterly monitoring requirement specified in paragraph (7)(g)(i) of this section provided it has determined that the system is reliably and consistently below the maximum contaminant level. In no case shall the Department make this determination unless a groundwater system takes a minimum of two quarterly samples and a surface water system takes a minimum of four quarterly samples.
 - (iii) After the Department determines the system is reliably and consistently below the maximum contaminant level the Department may allow the system to monitor annually. Systems which monitor annually must monitor during the quarter that previously yielded the highest analytical result.
 - (iv) Systems which have 3 consecutive annual samples with no detection of a contaminant may apply to the Department for a waiver as specified in paragraph (7)(f) of this section.
 - (v) Groundwater systems which have detected one or more of the following two-carbon organic compounds: trichloroethylene, tetrachloroethylene, 1,2-dichloroethane, 1,1,1-trichloroethane, cis-1,2-dichloroethylene, trans-1,2-dichloroethylene, or 1,1-dichloroethylene shall monitor quarterly for vinyl chloride. A vinyl chloride sample shall be taken at each sampling point at which one or more of the two-carbon organic compounds was detected. If the results of the first analysis do not detect vinyl chloride, the Department may reduce the quarterly monitoring frequency of vinyl chloride monitoring to one sample during each compliance period. Surface water systems are required to monitor for vinyl chloride as specified by the Department.
- (h) Systems which violate the requirements of Section D(2)(b) above, as determined by paragraph (7)(k) of this section must monitor quarterly. After a minimum of four quarterly samples show the system is in compliance and the Department determines the system is reliably and consistently below the MCL, as specified in paragraph (7)(k) of this section, the system shall monitor at the frequency specified in paragraph (7)(g)(iii) of this section.
 - (i) The Department may require a confirmation sample for positive or negative results. If a confirmation sample is required by the Department, the result must be averaged with the first sampling result and the average used for the compliance determination as specified by paragraph (7)(k) of this section. The Department has the discretion to delete results of obvious sampling errors from this calculation.
 - (j) The Department may reduce the total number of samples a system must analyze by allowing the use of compositing. Composite samples from a maximum of five sampling points are allowed, provided that the detection limit of the method used for analysis is less than one-fifth of the MCL. Compositing of samples must be done in the laboratory and analyzed within 14 days of sample collection.
 - (i) If the concentration in the composite sample detects one or more contaminants listed in Section D(2)(b) above, then a follow-up sample must be taken within 14 days at each sampling point included in the composite, and be analyzed for that contaminant.
 - (ii) If duplicates of the original sample taken from each sampling point used in the composite are available, the system may use these duplicates instead of resampling. The duplicate must be analyzed and the results reported to the Department within 14 days of collection.
 - (iii) If the population served by the system is more than 3,300 persons, then compositing may only be permitted by the Department at sampling points within a single system. In systems serving 3,300 persons or less, the Department may permit compositing among different systems provided the 5-sample limit is maintained.
 - (k) Compliance with Section D(2)(b) above, shall be determined based on the analytical results obtained at each sampling point. If one sampling point is in violation of an MCL, the system is in violation of the MCL.

(i) For systems monitoring more than once per year, compliance with the MCL is determined by a running annual average at each sampling point.

(ii) Systems monitoring annually or less frequently whose sample result exceeds the regulatory detection level as defined by paragraph (7)(r) of this section must begin quarterly sampling. The system will not be considered in violation of the MCL until it has completed one year of quarterly sampling.

(iii) If any sample result will cause the running annual average to exceed the MCL at any sampling point, the system is out of compliance with the MCL immediately.

(iv) If a system fails to collect the required number of samples, compliance will be based on the total number of samples collected.

(v) If a sample result is less than the detection limit, zero will be used to calculate the annual average.

(l) [Reserved]

(m) Analysis for PCBs shall be conducted using EPA-approved methods listed in 40 CFR 141.

(i) [Reserved]

(ii) [Reserved]

(iii) Compliance with the PCB MCL shall be determined based upon the quantitative results of analyses using EPA-approved methods listed in 40 CFR 141.

(n) If monitoring data collected after January 1, 1990, are generally consistent with the requirements of this section, then the Department may allow systems to use that data to satisfy the monitoring requirement for the initial compliance period beginning January 1, 1993.

(o) The Department may increase the required monitoring frequency, where necessary, to detect variations within the system (e.g., fluctuations in concentration due to seasonal use, changes in water source).

(p) The Department has the authority to determine compliance or initiate enforcement action based upon analytical results and other information compiled by the Department.

(q) Each public water system shall monitor at the time designated by the Department within each compliance period.

(r) Detection as used in this paragraph shall be defined as greater than or equal to the following concentrations for each contaminant.

Contaminant	Detection Limit
Atrazine	0.0001 mg/l
Benzo[a]pyrene	0.00002 mg/l
Carbofuran	0.0009 mg/l
Chlordane	0.0002 mg/l
Dalapon	0.001 mg/l
Dibromochloropropane (DBCP)	0.00002 mg/l
Di (2-ethylhexyl) adipate	0.0006 mg/l
Di (2-ethylhexyl) phthalate	0.0006 mg/l
Dinoseb	0.0002 mg/l
Diquat	0.0004 mg/l
2,4-D	0.0001 mg/l
Endothall	0.009 mg/l
Endrin	0.00001 mg/l
Ethylene dibromide (EDB)	0.00001 mg/l
Glyphosate	0.006 mg/l
Heptachlor	0.00004 mg/l
Heptachlor epoxide	0.00002 mg/l
Hexachlorobenzene	0.0001 mg/l
Hexachlorocyclopentadiene	0.0001 mg/l
Lindane	0.00002 mg/l
Methoxychlor	0.0001 mg/l
Oxamyl	0.002 mg/l
Picloram	0.0001 mg/l

Contaminant	Detection Limit
Polychlorinated biphenyls (PCBs) (as decachlorobiphenyl)	0.0001 mg/l
Pentachlorophenol	0.00004 mg/l
Simazine	0.00007 mg/l
Toxaphene	0.001 mg/l
2,3,7,8-TCDD (Dioxin)	0.000000005 mg/l
2,4,5-TP (Silvex)	0.0002 mg/l

(s) All new systems or systems that used a new source of water that begin operation after January 22, 2004 must demonstrate compliance with the MCL within a period of time specified by the Department. The system must also comply with the initial sampling frequencies specified by the Department to ensure a system can demonstrate compliance with the MCL. Routine and increased monitoring frequencies shall be conducted in accordance with the requirements in this section.

F. Maximum Contaminant Levels (MCLs) for Microbiological Contaminants.

These maximum contaminant levels shall apply to all public water systems.

(1) Until March 31, 2016, the total coliform MCL is based on the presence or absence of total coliforms in a sample, rather than coliform density.

(a) For a system which collects at least forty (40) samples per month, if no more than five (5.0) percent of the samples collected during a month are total coliform-positive, the system is in compliance with the MCL for total coliforms.

(b) For a system which collects fewer than forty (40) samples per month, if no more than one (1) sample collected during a month is total coliform -positive, the system is in compliance with the MCL for total coliforms.

(2) Until March 31, 2016, any fecal coliform-positive repeat sample or E. coli-positive repeat sample, or any total coliform-positive repeat sample following a fecal coliform-positive or E. coli-positive routine sample constitutes a violation of the MCL for total coliforms. For purposes of the public notification requirements in R.61 58.6.E, this is a violation that may pose an acute risk to health.

(3) Beginning April 1, 2016, a system is in compliance with the MCL for E. coli for samples taken under provisions of R.61-58.17 unless any of the conditions identified in R.61-58.5.F(3)(a) through (d) occur. For purposes of the public notification requirements in R.61-58.6.E, violation of the MCL may pose an acute risk to health.

(a) The system has an E. coli-positive repeat sample following a total coliform-positive routine sample.

(b) The system has a total coliform-positive repeat sample following an E. coli-positive routine sample.

(c) The system fails to take all required repeat samples following an E. coli-positive routine sample.

(d) The system fails to test for E. coli when any repeat sample tests positive for total coliform.

(4) Until March 31, 2016, a public water system must determine compliance with the MCL for total coliforms in R.61-58.5.F(1) and (2) for each month in which it is required to monitor for total coliforms. Beginning April 1, 2016, a public water system must determine compliance with the MCL for E. coli in R.61-58.5.F(3) for each month in which it is required to monitor for total coliforms.

(5) The United States Environmental Protection Agency Administrator, pursuant to section 1412 of the federal Safe Drinking Water Act, has identified the following as the best technology, treatment techniques, or other means available for achieving compliance with the maximum contaminant level for total coliforms in R.61-58.5.F (1)and (2) and for achieving compliance with the maximum contaminant level for E. coli in R.61-58.5.F(3):

(a) Protection of wells from fecal contamination by appropriate placement and construction;

(b) Maintenance of a disinfection residual throughout the distribution system;

(c) Proper maintenance of the distribution system including appropriate pipe placement and repair procedures, main flushing programs, proper operation and maintenance of storage tanks and reservoirs, cross connection control, and continual maintenance of positive water pressure in all parts of the distribution system;

(d) Filtration and/or disinfection of surface water, as described in R.61-58.10, or disinfection of ground water, as described in R.61-58.16, using strong oxidants such as chlorine, chlorine dioxide, or ozone; and

(e) For systems using ground water, compliance with the requirements of an EPA-approved Department Wellhead Protection Program developed and implemented under section 1428 of the federal Safe Drinking Water Act.

(6) The United States Environmental Protection Agency Administrator, pursuant to section 1412 of the federal Safe Drinking Water Act, identifies the technology, treatment techniques, or other means available identified in R.61-58.5.F(5) as affordable technology, treatment techniques, or other means available to systems serving 10,000 or fewer people for achieving compliance with the maximum contaminant level for total coliforms in R.61-58.5.F(1) and (2) and for achieving compliance with the maximum contaminant level for E. coli in R.61-58.5.F(3).

G. Microbiological Contaminant Sampling and Analytical Requirements.

These sampling and analytical requirements shall apply to community and non-community water systems. Analytical methods used to comply with Section F above, shall be made using EPA-approved methods listed in 40 CFR 141.

(1) Routine Monitoring.

(a) Community and non-community water systems shall collect total coliform samples at sites which are representative of water throughout the distribution system according to a written sample siting plan. These plans are subject to Department review and revision.

(b) The monitoring frequency for total coliforms for community water systems is based on the population served by the system, as follows:

Population Served	Minimum # of Samples Per Month
25 to 1,000 ¹	1
1,001 to 2,500	2
2,501 to 3,300	3
3,301 to 4,100	4
4,101 to 4,900	5
4,901 to 5,800	6
5,801 to 6,700	7
6,701 to 7,600	8
7,601 to 8,500	9
8,501 to 12,900	10
12,901 to 17,200	15
17,201 to 21,500	20
21,501 to 25,000	25
25,001 to 33,000	30
33,001 to 41,000	40
41,001 to 50,000	50
50,001 to 59,000	60
59,001 to 70,000	70
70,001 to 83,000	80
83,001 to 96,000	90
96,001 to 130,000	100
130,001 to 220,000	120
220,001 to 320,000	150
320,001 to 450,000	180
450,001 to 600,000	210
600,001 to 780,000	240
780,001 to 970,000	270
970,001 to 1,230,000	300
1,230,001 to 1,520,000	330
1,520,001 to 1,850,000	360

Population Served	Minimum # of Samples Per Month
1,850,001 to 2,270,000	390
2,270,001 to 3,020,000	420
3,020,001 to 3,960,000	450
3,960,001 or more	480

¹ Includes public water systems which have at least fifteen (15) service connections, but serve fewer than twenty-five (25) persons.

If a community water system serving twenty-five (25) to one-thousand (1,000) persons has no history of total coliform contamination in its current configuration and a sanitary survey conducted in the past five years shows that the system is supplied solely by a protected groundwater source and is free of sanitary defects, the Department may reduce the monitoring frequency specified above, except that in no case may the Department reduce the monitoring frequency to less than one sample per quarter. The Department must approve the reduced monitoring frequency in writing.

(i) [Reserved]

(ii) Community water systems shall make at a minimum one fecal or total coliform density measurement each day from the raw water source, and one coliform density or presence/absence measurement from the finished water, if treating surface water. This requirement may be waived by the Department on a case-by-case basis if a public water supply can demonstrate that such monitoring is unnecessary.

(c) The monitoring frequency for total coliforms for non-community water systems is as follows:

(i) A non-community water system using only ground water (except ground water under the direct influence of surface water) and serving one-thousand (1,000) persons or fewer shall monitor each calendar quarter that the system provides water to the public, except that the Department may reduce this monitoring frequency, in writing, if a sanitary survey shows that the system is free of sanitary defects. Beginning June 29, 1994, the Department cannot reduce the monitoring frequency for a non-community water system using only ground water (except ground water under the direct influence of surface water) and serving one-thousand (1,000) persons or fewer to less than once per year.

(ii) A non-community water system using only ground water (except ground water under the direct influence of surface water) and serving more than one-thousand (1,000) persons during any month shall monitor at the same frequency as a like-sized community water system, as specified in paragraph (1)(b) of this section, except that the Department may reduce this monitoring frequency, in writing, for any month the system serves one-thousand (1,000) persons or fewer. The Department cannot reduce the monitoring frequency to less than once per year. For systems using ground water under the direct influence of surface water, paragraph (1)(c)(iv) of this section applies.

(iii) A non-community water system using surface water, in total or in part, shall monitor at the same frequency as a like-sized community water system, as specified in paragraph (1)(b) of this section, regardless of the number of persons it serves.

(iv) A non-community water system using ground water under the direct influence of surface water shall monitor at the same frequency as a like-sized community water system, as specified in paragraph (1)(b) of this section. The system shall begin monitoring at this frequency beginning six (6) months after the Department determines that the ground water is under the direct influence of surface water.

(d) The community or non-community water system shall collect samples at regular time intervals throughout the month, except that a system which uses ground water (except ground water under the direct influence of surface water), and serves 4,900 persons or fewer, may collect all required samples on a single day if they are taken from different sites.

(e) A community or non-community water systems that uses surface water or ground water under the direct influence of surface water and does not practice filtration in compliance with R.61-58.10 shall collect at least one sample near the first service connection each day the turbidity level of the source water, measured as specified in R.61-58.10.F(2)(b), exceeds 1 NTU. This sample shall be analyzed for the presence of total coliforms. When one or more turbidity measurements in any day exceed 1 NTU, the system shall collect this coliform sample within 24

hours of the first exceedance, unless the Department determines that the system, for logistical reasons outside the system's control, cannot have the sample analyzed within thirty (30) hours of collection. Sample results from this coliform monitoring shall be included in determining compliance with the MCL for total coliforms in Section F above.

(f) Special purpose samples, such as those taken to determine whether disinfection practices are sufficient following pipe placement, replacement, or repair, shall not be used to determine compliance with the MCL for total coliforms in Section F above. Repeat samples taken pursuant to paragraph (2) of this section are not considered special purpose samples, and shall be used to determine compliance with the MCL for total coliforms in Section F above.

(2) Repeat Monitoring.

(a) If a routine sample is total coliform-positive, the community or non-community water system shall collect a set of repeat samples within twenty-four (24) hours of being notified of the positive result. A system which collects more than one routine sample per month shall collect no fewer than three repeat samples for each total coliform-positive sample found. A system which collects one routine sample per month or fewer shall collect no fewer than four repeat samples for each total coliform-positive sample found. The Department may extend the twenty-four (24) hour limit on a case-by-case basis if the system has a logistical problem in collecting the repeat samples within twenty-four (24) hours that is beyond its control. In the case of an extension, the Department shall specify how much time the system has to collect the repeat samples.

(b) The system shall collect at least one repeat sample from the sampling tap where the original total coliform-positive sample was taken, and at least one repeat sample at a tap within five service connections upstream and at least one repeat sample at a tap within five (5) service connections downstream of the original sampling site. If a total coliform-positive sample is at the end of the distribution system, or one away from the end of the distribution system, the Department may waive the requirement to collect at least one repeat sample upstream or downstream of the original sampling site.

(c) The system shall collect all repeat samples on the same day, except that the Department may allow a system with a single service connection to collect the required set of repeat samples over a four-day period or to collect a larger volume repeat sample(s) in one or more sample containers of any size, as long as the total volume collected is at least 400 ml (300 ml for systems which collect more than one routine sample per month).

(d) If one or more repeat samples in the set is total coliform-positive, the water system shall collect an additional set of repeat samples in the manner specified in paragraphs (2)(a) through (c) of this section. The additional samples shall be collected within twenty-four (24) hours of being notified of the positive result, unless the Department extends the limit as provided in paragraph (2)(a) of this section. The system shall repeat this process until either total coliforms are not detected in one complete set of repeat samples or the system determines that the MCL for total coliforms in Section F above, has been exceeded and notifies the Department.

(e) If a system collecting fewer than five routine samples per month has one or more total coliform-positive samples and the Department does not invalidate the sample(s) under paragraph (3) of this section, it shall collect at least five routine samples during the next month the system provides water to the public, except that the Department may waive this requirement if the conditions of paragraph (2)(e)(i) or (ii) of this section are met. The Department cannot waive the requirement for a system to collect repeat samples in paragraphs (2)(a) through (d) of this section.

(i) The Department may waive the requirement to collect five routine samples the next month the system provides water to the public if the Department, or an agent approved by the Department, performs a site visit before the end of the next month the system provides water to the public. Although a sanitary survey need not be performed, the site visit shall be sufficiently detailed to allow the Department to determine whether additional monitoring and/or any corrective action is needed. The Department cannot approve an employee of the system to perform this site visit, even if the employee is an agent approved by the Department to perform sanitary surveys.

(ii) The Department may waive the requirement to collect five routine samples the next month the system provides water to the public if the Department has determined why the

sample was total coliform-positive and establishes that the system has corrected the problem or will correct the problem before the end of the next month the system serves water to the public. In this case, the Department shall document this decision to waive the following month's additional monitoring requirement in writing, have it approved and signed by the supervisor of the Department official who recommends such a decision, and make this document available to the EPA and public. The written documentation shall describe the specific cause of the total coliform-positive sample and what action the system has taken and/or will take to correct this problem. The Department cannot waive the requirement to collect five routine samples the next month the system provides water to the public solely on the grounds that all repeat samples are total coliform-negative. Under this paragraph, a system shall still take at least one routine sample before the end of the next month it serves water to the public and use it to determine compliance with the MCL for total coliforms in R.61-58.5.F, unless the Department has determined that the system has corrected the contamination problem before the system took the set of repeat samples required in paragraphs (2)(a) through (d) of this section, and all repeat samples were total coliform-negative.

(f) After a system collects a routine sample and before it learns the results of the analysis of that sample, if it collects another routine sample(s) from within five adjacent service connections of the initial sample, and the initial sample, after analysis, is found to contain total coliforms, then the system may count the subsequent sample(s) as a repeat sample instead of as a routine sample.

(g) Results of all routine and repeat samples not invalidated by the Department shall be included in determining compliance with the MCL for total coliforms in Section F above.

(3) Invalidation of total coliform samples.

A total coliform-positive sample invalidated under this paragraph does not count towards meeting the minimum monitoring requirements of this section.

(a) The Department may invalidate a total coliform-positive sample only if the conditions of paragraph (3)(a)(i), (ii) or (iii) of this section are met.

(i) The laboratory establishes that improper sample analysis caused the total coliform-positive result.

(ii) The Department, on the basis of the results of repeat samples collected as required by paragraphs (2)(a) through (d) of this section, determines that the total coliform-positive sample resulted from a domestic or other non-distribution system plumbing problem. The Department cannot invalidate a sample on the basis of repeat sample results unless all repeat sample(s) collected at the same tap as the original total coliform-positive sample are also total coliform-positive, and all repeat samples collected within five service connections of the original tap are total coliform-negative (e.g., the Department cannot invalidate a total coliform-positive sample on the basis of repeat samples if all the repeat samples are total coliform-negative, or if the public water system has only one service connection).

(iii) The Department has substantial grounds to believe that a total coliform-positive result is due to a circumstance or condition which does not reflect water quality in the distribution system. In this case, the system shall still collect all repeat samples required under paragraphs (2)(a) through (d) of this section, and use them to determine compliance with the MCL for total coliforms in Section F above. To invalidate a total coliform-positive sample under this paragraph, the decision with the rationale for the decision shall be documented in writing, and approved and signed by the supervisor of the Department official who recommended the decision. The Department shall make this document available to the EPA and the public. The written documentation shall state the specific cause of the total coliform-positive sample, and what action the system has taken, or will take, to correct this problem. The Department may not invalidate a total coliform-positive sample solely on the grounds that all repeat samples are total coliform-negative.

(b) A laboratory shall invalidate a total coliform sample (unless total coliforms are detected) if the sample produces a turbid culture in the absence of gas production using an analytical method where gas formation is examined (e.g., the Multiple-Tube Fermentation Technique), produces a turbid culture in the absence of an acid reaction in the Presence-Absence (P-A) Coliform Test, or exhibits confluent growth or produces colonies too numerous to count with an analytical method

using a membrane filter (e.g., Membrane Filter Technique). If a laboratory invalidates a sample because of such interference, the Department shall be notified, and the system shall collect another sample from the same location as the original sample within twenty-four (24) hours of being notified of the interference problem, and shall have it analyzed for the presence of total coliforms. The system shall continue to re-sample within twenty-four (24) hours and have the samples analyzed until it obtains a valid result. The Department may waive the twenty-four (24) hour time limit on a case-by-case basis.

(4) Sanitary Surveys.

(a)(i) Public water systems which do not collect five (5) or more routine samples per month shall undergo an initial sanitary survey by June 29, 1994, for community water systems and June 29, 1999, for non-community water systems. hereafter, systems shall undergo another sanitary survey every five (5) years, except that non-community water systems using only protected and disinfected ground water, as defined by the Department, shall undergo subsequent sanitary surveys at least every ten (10) years after the initial sanitary survey. The Department shall review the results of each sanitary survey to determine whether the existing monitoring frequency is adequate and what additional measures, if any, the system needs to undertake to improve drinking water quality.

(ii) In conducting a sanitary survey of a system using ground water in a State having an EPA-approved wellhead protection program under the Federal Safe Drinking Water Act, information on sources of contamination within the delineated wellhead protection area that was collected in the course of developing and implementing the program should be considered instead of collecting new information, if the information was collected since the last time the system was subject to a sanitary survey.

(b) Sanitary surveys shall be performed by the Department or an agent approved by the Department. The system is responsible for ensuring the survey takes place.

(c) Sanitary surveys conducted by the Department under the provisions of 40 CFR 142.16(o)(2) may be used to meet the sanitary survey requirements of R.61-58.5.G(4).

(5) Fecal coliforms/*Escherichia coli* (*E. coli*) testing.

(a) If any routine or repeat sample is total coliform positive, the system shall analyze that total coliform-positive culture medium to determine if fecal coliforms are present, except that the system may test for *E. coli* in lieu of fecal coliforms. If fecal coliforms or *E. coli* are present, the system shall notify the Department by the end of the day when the system is notified of the test result, unless the system is notified of the result after the Department is closed, in which case the system shall notify the Department before the end of the next business day.

(b) The Department has the discretion to allow a public water system, on a case-by-case basis, to forego fecal coliform or *E. coli* testing on a total coliform-positive sample if that system assumes that the total coliform-positive sample is fecal coliform-positive or *E. coli*-positive. Accordingly, the system shall notify the Department as specified in paragraph (5)(a) of this section and the provisions of Section F(2) above, apply.

(6) Analytical methodology.

(a) The standard sample volume required for total coliform analysis, regardless of analytical method used, is 100 ml.

(b) Water systems need only determine the presence or absence of total coliforms; a determination of total coliform density is not required.

(c) Analytical methods used to comply with R.61-58.5.G shall be in accordance with EPA-approved methods listed in 40 CFR 141 (11-8-06 edition).

(d) Water systems must conduct fecal coliform analysis in accordance with the procedure outlined in 40 CFR 141.21(f)(5) (11-8-06 edition).

(e) Water systems must conduct *Escherichia coli* analysis in accordance with the analytical methods outlined in 40 CFR 141.21(f)(6) (11-8-06 edition).

(7) Response to violation.

(a) A water system which has exceeded the MCL for total coliforms in Section F above, shall report the violation to the Department no later than the end of the next business day after it learns of the violation, and shall notify the public in accordance with R.61-58.6.E.

(b) A water system which has failed to comply with a coliform monitoring requirement, including the sanitary survey requirement, shall report the monitoring violation to the Department within ten days after the system discovers the violation, and shall notify the public in accordance with R.61-58.6.E.

(8) The provisions of R.61-58.5.G(1) and (4) are applicable until March 31, 2016. The provisions of R.61-58.5.G(2), (3), (5), (6), and (7) are applicable until all required repeat monitoring under R.61-58.5.G(2) and fecal coliform or E. coli testing under R.61-58.5.G(5) that was initiated by a total coliform-positive sample taken before April 1, 2016 is completed, as well as analytical method, reporting, recordkeeping, public notification, and consumer confidence report requirements associated with that monitoring and testing. Beginning April 1, 2016, the provisions of R.61-58.17 are applicable, with systems required to begin regular monitoring at the same frequency as the system-specific frequency required on March 31, 2016.

H. Maximum Contaminant Levels for Radionuclides.

(1) The maximum contaminant level for radionuclides are applicable to all public water systems. Compliance with the maximum contaminant levels for radionuclides is calculated pursuant to Section I below.

(2) MCL for combined radium-226 and -228. The maximum contaminant level for combined radium-226 and radium-228 is 5 pCi/L. The combined radium-226 and radium-228 value is determined by the addition of the results of the analysis for radium-226 and the analysis for radium-228.

(3) MCL for gross alpha particle activity (excluding radon and uranium). The maximum contaminant level for gross alpha particle activity (including radium-226 but excluding radon and uranium) is 15 pCi/L.

(4) MCL for beta particle and photon radioactivity.

(a) The average annual concentration of beta particle and photon radioactivity from man-made radionuclides in drinking water must not produce an annual dose equivalent to the total body or any internal organ greater than 4 millirem/year (mrem/year).

(b) Except for the radionuclides listed in Table A, the concentration of man-made radionuclides causing 4 mrem total body or organ dose equivalents must be calculated on the basis of two (2) liters per day drinking water intake using the 168 hour data list in "Maximum Permissible Body Burdens and Maximum Permissible Concentrations of Radionuclides in Air and in Water for Occupational Exposure," NBS (National Bureau of Standards) Handbook 69 as amended August 1963, U.S. Department of Commerce. This incorporation by reference was approved by the Director of the Federal Register in accordance with 5 U.S.C. 552(a) and 1 CFR part 51. Copies of this document are available from the National Technical Information Service, NTIS ADA 280 282, U.S. Department of Commerce, 5285 Port Royal Road, Springfield, Virginia 22161. The toll-free number is 800-553-6847. Copies may be inspected at EPA's Drinking Water Docket, 401 M Street, SW, Washington, DC 20460; or at the Office of the Federal Register, 800 North Capitol Street, NW, Suite 700, Washington, DC. If two or more radionuclides are present, the sum of their annual dose equivalent to the total body or to any organ shall not exceed 4 mrem/year.

TABLE A: AVERAGE ANNUAL CONCENTRATIONS ASSUMED TO PRODUCE A TOTAL BODY OR ORGAN DOSE OF 4 MREM/YR

Radionuclide	Critical organ	pCi per liter
1. Tritium	Total body	20,000
2. Strontium-90	Bone Marrow	8

(5) MCL for uranium. The maximum contaminant level for uranium is 30 µg/L.

(6) Compliance dates. Compliance dates for combined radium-226 and -228, gross alpha particle activity, gross beta particle and photon radioactivity, and uranium: Community water systems must

comply with the MCLs listed in paragraphs (2), (3), (4), and (5) of this section beginning December 8, 2003 and compliance shall be determined in accordance with the requirements of Sections I and K below. Compliance with reporting requirements for the radionuclides under Appendix D to R.61-58.12 and Appendices A and B to R.61-58.6 is required on December 8, 2003.

(7) Best available technologies (BATs) for radionuclides. The Administrator, pursuant to section 1412 of the Federal Safe Drinking Water Act, hereby identifies as indicated in the following table the best technology available for achieving compliance with the maximum contaminant levels for combined radium-226 and -228, uranium, gross alpha particle activity, and beta particle and photon radioactivity.

TABLE B: BAT FOR COMBINED RADIUM-226 AND RADIUM-228, URANIUM, GROSS ALPHA PARTICLE ACTIVITY, AND BETA PARTICLE AND PHOTON RADIOACTIVITY

CONTAMINANT	BAT
1. Combined radium-226 and radium-228	Ion exchange, reverse osmosis, lime softening.
2. Uranium	Ion exchange, reverse osmosis, lime softening, coagulation/filtration.
3. Gross alpha particle activity (excluding Radon and Uranium)	Reverse osmosis.
4. Beta particle and photon radioactivity	Ion exchange, reverse osmosis.

(8) Small systems compliance technologies list for radionuclides.

TABLE C: LIST OF SMALL SYSTEMS COMPLIANCE TECHNOLOGIES FOR RADIONUCLIDES AND LIMITATIONS TO USE

Unit technologies	Limitations (see footnotes)	Operator skill level required. ¹	Raw water quality range and considerations. ¹
1. Ion exchange (IE)	(a)	Intermediate	All ground waters.
2. Point of use (POU ²) IE	(b)	Basic	All ground waters.
3. Reverse osmosis (RO)	(c)	Advanced	Surface waters usually require pre-filtration.
4. POU ² RO	(b)	Basic	Surface waters usually require pre-filtration.
5. Lime softening	(d)	Advanced	All waters.
6. Green sand filtration	(e)	Basic.	
7. Co-precipitation with Barium sulfate	(f)	Intermediate to Advanced	Ground waters with suitable water quality.
8. Electrodialysis/electrodialysis reversal	Basic to Intermediate	All ground waters.
9. Pre-formed hydrous Manganese oxide filtration	(g)	Intermediate	All ground waters.
10. Activated alumina	(a), (h)	Advanced	All ground waters; competing anion con-

Unit technologies	Limitations (see footnotes)	Operator skill level required. ¹	Raw water quality range and considerations. ¹
11. Enhanced coagulation/filtration	(i)	Advanced	concentrations may affect regeneration frequency. Can treat a wide range of water qualities.

¹ National Research Council (NRC). Safe Water from Every Tap: Improving Water Service to Small Communities. National Academy Press. Washington, D.C. 1997.

² A POU, or “point-of-use” technology is a treatment device installed at a single tap used for the purpose of reducing contaminants in drinking water at that one tap. POU devices are typically installed at the kitchen tap. See the April 21, 2000 NODA for more details.

Limitations Footnotes: Technologies for Radionuclides:

^a The regeneration solution contains high concentrations of the contaminant ions. Disposal options should be carefully considered before choosing this technology.

^b When POU devices are used for compliance, programs for long-term operation, maintenance, and monitoring must be provided by water utility to ensure proper performance.

^c Reject water disposal options should be carefully considered before choosing this technology. See other RO limitations described in the SWTR Compliance Technologies Table.

^d The combination of variable source water quality and the complexity of the water chemistry involved may make this technology too complex for small surface water systems.

^e Removal efficiencies can vary depending on water quality.

^f This technology may be very limited in application to small systems. Since the process requires static mixing, detention basins, and filtration, it is most applicable to systems with sufficiently high sulfate levels that already have a suitable filtration treatment train in place.

^g This technology is most applicable to small systems that already have filtration in place.

^h Handling of chemicals required during regeneration and pH adjustment may be too difficult for small systems without an adequately trained operator.

ⁱ Assumes modification to a coagulation/filtration process already in place.

TABLE D: COMPLIANCE TECHNOLOGIES BY SYSTEM SIZE CATEGORY FOR RADIONUCLIDES

Contaminant	Compliance technologies ¹ for system size categories (population served)		
	25—500	501—3,300	3,300—10,000
1. Combined radium-226 and radium-228	1, 2, 3, 4, 5, 6, 7, 8, 9	1, 2, 3, 4, 5, 6, 7, 8, 9	1, 2, 3, 4, 5, 6, 7, 8, 9
2. Gross alpha particle activity	3, 4	3, 4	3, 4
3. Beta particle activity and photon activity	1, 2, 3, 4	1, 2, 3, 4	1, 2, 3, 4
4. Uranium	1, 2, 4, 10, 11	1, 2, 3, 4, 5, 10, 11	1, 2, 3, 4, 5, 10, 11

¹ Numbers correspond to those technologies found listed in the Table C above.

I. Monitoring Frequency and Compliance Requirements for Radionuclides in Community Water Systems.

(1) This section shall apply only to community water systems which serve at least fifteen (15) service connections used by year-round residents or systems which regularly serve at least twenty-five (25) year-round residents. Suppliers of water for applicable community water systems shall analyze for radionuclides to determine compliance with Section H above.

(2) The monitoring and compliance requirements for gross alpha particle activity, radium-226, radium-228, and uranium.

(a) Community water systems (CWSs) must conduct initial monitoring to determine compliance with Section H(2), (3) and (5) above by December 31, 2007. For the purposes of monitoring for gross alpha particle activity, radium-226, radium-228, uranium, and beta particle and photon radioactivity in drinking water, "detection limit" is defined as in Section K(3) below.

(i) Applicability and sampling location for existing community water systems or sources. All existing CWSs using ground water, surface water or systems using both ground and surface water (for the purpose of this section hereafter referred to as systems) must sample at every entry point to the distribution system that is representative of all sources being used (hereafter called a sampling point) under normal operating conditions. The system must take each sample at the same sampling point unless conditions make another sampling point more representative of each source or the Department has designated a distribution system location, in accordance with paragraph (2)(b)(ii)(C) of this section.

(ii) Applicability and sampling location for new community water systems or sources. All new CWSs or CWSs that use a new source of water must begin to conduct initial monitoring for the new source within the first quarter after initiating use of the source. CWSs must conduct more frequent monitoring when ordered by the Department in the event of possible contamination or when changes in the distribution system or treatment processes occur which may increase the concentration of radioactivity in finished water.

(b) Initial monitoring: Systems must conduct initial monitoring for gross alpha particle activity, radium-226, radium-228, and uranium as follows:

(i) Systems without acceptable historical data, as defined below, must collect four consecutive quarterly samples at all sampling points before December 31, 2007.

(ii) Grandfathering of data: The Department may allow historical monitoring data collected at a sampling point to satisfy the initial monitoring requirements for that sampling point, for the following situations.

(A) To satisfy initial monitoring requirements, a community water system having only one entry point to the distribution system may use the monitoring data from the last compliance monitoring period that began between June 2000 and December 8, 2003.

(B) To satisfy initial monitoring requirements, a community water system with multiple entry points and having appropriate historical monitoring data for each entry point to the distribution system may use the monitoring data from the last compliance monitoring period that began between June 2000 and December 8, 2003.

(C) To satisfy initial monitoring requirements, a community water system with appropriate historical data for a representative point in the distribution system may use the monitoring data from the last compliance monitoring period that began between June 2000 and December 8, 2003, provided that the Department finds that the historical data satisfactorily demonstrate that each entry point to the distribution system is expected to be in compliance based upon the historical data and reasonable assumptions about the variability of contaminant levels between entry points. The Department must make a written finding indicating how the data conforms to these requirements.

(iii) For gross alpha particle activity, uranium, radium-226, and radium-228 monitoring, the Department may waive the final two quarters of initial monitoring for a sampling point if the results of the samples from the previous two (2) quarters are below the detection limit.

(iv) If the average of the initial monitoring results for a sampling point is above the MCL, the system must collect and analyze quarterly samples at that sampling point until the system has results from four (4) consecutive quarters that are at or below the MCL, unless the system enters into another schedule as part of a formal compliance agreement with the Department.

(c) Reduced monitoring: The Department may allow community water systems to reduce the future frequency of monitoring from once every three (3) years to once every six (6) or nine (9) years at each sampling point, based on the following criteria.

(i) If the average of the initial monitoring results for each contaminant (i.e., gross alpha particle activity, uranium, radium-226, or radium-228) is below the detection limit specified in

Table B, in Section K(3)(a) below, the system must collect and analyze for that contaminant using at least one (1) sample at that sampling point every nine (9) years.

(ii) For gross alpha particle activity and uranium, if the average of the initial monitoring results for each contaminant is at or above the detection limit but at or below one-half (1/2) the MCL, the system must collect and analyze for that contaminant using at least one (1) sample at that sampling point every six (6) years. For combined radium-226 and radium-228, the analytical results must be combined. If the average of the combined initial monitoring results for radium-226 and radium-228 is at or above the detection limit but at or below one-half (1/2) the MCL, the system must collect and analyze for that contaminant using at least one (1) sample at that sampling point every six (6) years.

(iii) For gross alpha particle activity and uranium, if the average of the initial monitoring results for each contaminant is above one-half (1/2) the MCL but at or below the MCL, the system must collect and analyze at least one (1) sample at that sampling point every three (3) years. For combined radium-226 and radium-228, the analytical results must be combined. If the average of the combined initial monitoring results for radium-226 and radium-228 is above one-half (1/2) the MCL but at or below the MCL, the system must collect and analyze at least one (1) sample at that sampling point every three (3) years.

(iv) Systems must use the samples collected during the reduced monitoring period to determine the monitoring frequency for subsequent monitoring periods (e.g., if a system's sampling point is on a nine (9) year monitoring period, and the sample result is above one-half (1/2) MCL, then the next monitoring period for that sampling point is three (3) years).

(v) If a system has a monitoring result that exceeds the MCL while on reduced monitoring, the system must collect and analyze quarterly samples at that sampling point until the system has results from four (4) consecutive quarters that are below the MCL, unless the system enters into another schedule as part of a formal compliance agreement with the Department.

(d) Compositing: To fulfill quarterly monitoring requirements for gross alpha particle activity, radium-226, radium-228, or uranium, a system may composite up to four (4) consecutive quarterly samples from a single entry point if analysis is done within a year of the first sample. The Department will treat analytical results from the composited as the average analytical result to determine compliance with the MCLs and the future monitoring frequency. If the analytical result from the composited sample is greater than one-half (1/2) MCL, the Department may direct the system to take additional quarterly samples before allowing the system to sample under a reduced monitoring schedule.

(e) A gross alpha particle activity measurement may be substituted for the required radium-226 measurement provided that the measured gross alpha particle activity does not exceed 5 pCi/l. A gross alpha particle activity measurement may be substituted for the required uranium measurement provided that the measured gross alpha particle activity does not exceed 15 pCi/l.

The gross alpha measurement shall have a confidence interval of 95 percent (1.65 sigma, where sigma is the standard deviation of the net counting rate of the sample) for radium-226 and uranium. When a system uses a gross alpha particle activity measurement in lieu of a radium-226 and/or uranium measurement, the gross alpha particle activity analytical result will be used to determine the future monitoring frequency for radium-226 and/or uranium. If the gross alpha particle activity result is less than detection, one-half (1/2) the detection limit will be used to determine compliance and the future monitoring frequency.

(3) Monitoring and compliance requirements for beta particle and photon radioactivity.

To determine compliance with the maximum contaminant levels in Section H(4) above for beta particle and photon radioactivity, a system must monitor at a frequency as follows:

(a) Community water systems (both surface and ground water) designated by the Department as vulnerable must sample for beta particle and photon radioactivity. Systems must collect quarterly samples for beta emitters and annual samples for tritium and strontium-90 at each entry point to the distribution system (hereafter called a sampling point), beginning within one quarter after being notified by the Department. Systems already designated by the Department must continue to sample until the Department reviews and either reaffirms or removes the designation.

(i) If the gross beta particle activity minus the naturally occurring potassium-40 beta particle activity at a sampling point has a running annual average (computed quarterly) less than or equal to 50 pCi/L (screening level), the Department may reduce the frequency of monitoring at that sampling point to once every three (3) years. Systems must collect all samples required in paragraph (3)(a) of this section during the reduced monitoring period.

(ii) For systems in the vicinity of a nuclear facility, the Department may allow the CWS to utilize environmental surveillance data collected by the nuclear facility in lieu of monitoring at the system's entry point(s), where the Department determines if such data is applicable to a particular water system. In the event that there is a release from a nuclear facility, systems which are using surveillance data must begin monitoring at the community water system's entry point(s) in accordance with paragraph (3)(a) of this section.

(b) Community water systems (both surface and ground water) designated by the Department as utilizing waters contaminated by effluents from nuclear facilities must sample for beta particle and photon radioactivity. Systems must collect quarterly samples for beta emitters and iodine-131 and annual samples for tritium and strontium-90 at each entry point to the distribution system (hereafter called a sampling point), beginning within one quarter after being notified by the Department. Systems already designated by the Department as systems using waters contaminated by effluents from nuclear facilities must continue to sample until the Department reviews and either reaffirms or removes the designation.

(i) Quarterly monitoring for gross beta particle activity shall be based on the analysis of monthly samples or the analysis of a composite of three monthly samples. The former is recommended.

(ii) For iodine-131, a composite of five consecutive daily samples shall be analyzed once each quarter. As ordered by the Department, more frequent monitoring shall be conducted when iodine-131 is identified in the finished water.

(iii) Annual monitoring for strontium-90 and tritium shall be conducted by means of the analysis of a composite of four consecutive quarterly samples or analysis of four quarterly samples. The latter procedure is recommended.

(iv) If the gross beta particle activity minus the naturally occurring potassium-40 beta particle activity at a sampling point has a running annual average (computed quarterly) less than or equal to 15 pCi/L (screening level), the Department may reduce the frequency of monitoring at that sampling point to every three (3) years. Systems must collect all samples required in paragraph (2)(a) of this section during the reduced monitoring period.

(v) For systems in the vicinity of a nuclear facility, the Department may allow the CWS to utilize environmental surveillance data collected by the nuclear facility in lieu of monitoring at the system's entry point(s), where the Department determines if such data is applicable to a particular water system. In the event that there is a release from a nuclear facility, systems which are using surveillance data must begin monitoring at the community water system's entry point(s) in accordance with paragraph (3)(b) of this section.

(c) Community water systems designated by the Department to monitor for beta particle and photon radioactivity can not apply to the Department for a waiver from the monitoring frequencies specified in paragraph (3)(a) or (3)(b) of this section.

(d) Community water systems may analyze for naturally occurring potassium-40 beta particle activity from the same or equivalent sample used for the gross beta particle activity analysis. Systems are allowed to subtract the potassium-40 beta particle activity value from the total gross beta particle activity value to determine if the screening level is exceeded. The potassium-40 beta particle activity must be calculated by multiplying elemental potassium concentrations (in mg/L) by a factor of 0.82.

(e) If the gross beta particle activity minus the naturally occurring potassium-40 beta particle activity exceeds the appropriate screening level, an analysis of the sample must be performed to identify the major radioactive constituents present in the sample and the appropriate doses must be calculated and summed to determine compliance with Section H(4)(a) above, using the formula in Section H(4)(b) above. Doses must also be calculated and combined for measured levels of tritium and strontium to determine compliance.

(f) Systems must monitor monthly at the sampling point(s) which exceed the maximum contaminant level in R.61-58.5.H(4)(a), beginning the month after the exceedance occurs. Systems must continue monthly monitoring until the system has established, by a rolling average of three (3) monthly samples, that the MCL is being met. Systems who establish that the MCL is being met must return to quarterly monitoring until they meet the requirements set forth in paragraphs (3)(a)(i) or (3)(b)(iv) of this section.

(4) General monitoring and compliance requirements for radionuclides.

(a) The Department may require more frequent monitoring than specified R.61-58.5.I(1) or (2), or may require confirmation samples at its discretion. The results of the initial and confirmation samples will be averaged for use in compliance determinations.

(b) Each public water systems shall monitor at the time designated by the Department during each compliance period.

(c) Compliance: Compliance with Section H(2) through (5) above, will be determined based on the analytical result(s) obtained at each sampling point. If one (1) sampling point is in violation of an MCL, the system is in violation of the MCL.

(i) For systems monitoring more than once per year, compliance with the MCL is determined by a running annual average at each sampling point. If the average of any sampling point is greater than the MCL, then the system is out of compliance with the MCL.

(ii) For systems monitoring more than once per year, if any sample result will cause the running average to exceed the MCL at any sample point, the system is out of compliance with the MCL immediately.

(iii) Systems must include all samples taken and analyzed under the provisions of this section in determining compliance, even if that number is greater than the minimum required.

(iv) If a system does not collect all required samples when compliance is based on a running annual average of quarterly samples, compliance will be based on the running average of the samples collected.

(v) If a sample result is less than the detection limit, zero will be used to calculate the annual average, unless a gross alpha particle activity is being used in lieu of radium-226 and/or uranium. If the gross alpha particle activity result is less than detection, one-half (1/2) the detection limit will be used to calculate the annual average.

(d) The Department has the discretion to delete results of obvious sampling or analytic errors.

(e) If the MCL for radioactivity set forth in Section H(2) through (5) above, is exceeded, the operator of a community water system must give notice to the Department and the public pursuant to R.61-58.6(B) and (E).

J. Maximum Contaminant Level Goals for Radionuclides.

MCLGs for radionuclides are as indicated in the following table:

Contaminant	MCLG
1. Combined radium-226 and radium-228	Zero.
2. Gross alpha particle activity (excluding radon and uranium)	Zero.
3. Beta particle and photon radioactivity	Zero.
4. Uranium	Zero.

K. Analytical Methods for Radionuclides.

(1) Analysis for the following contaminants shall be conducted to determine compliance with Section H above, (radioactivity) in accordance with the methods adopted by the Department.

(2) For the purpose of monitoring radioactivity concentrations in drinking water, the required sensitivity of the radio-analysis is defined in terms of detection limit. The detection limit shall be that concentration which can be counted with a precision of plus or minus one hundred percent at the ninety-five percent confidence level (1.96 sigma where sigma is the standard deviation of the net counting rate of the sample). To determine compliance with Sections H and J above, the detection limits shall not exceed those set form by the Administrator.

(3) To judge compliance with the maximum contaminant levels listed in Sections H and J above, averages of data shall be used and shall be round to the same number of significant figures as the maximum contaminant level for the substance in question.

(a) To determine compliance with Section H(2), (3), and (5) above, the detection limit shall not exceed the concentrations in Table B to this paragraph.

TABLE B: DETECTION LIMITS FOR GROSS ALPHA PARTICLE ACTIVITY, RADIUM 226, RADIUM 228, AND URANIUM

Contaminant	Detection limit
Gross alpha particle activity	3 pCi/L.
Radium 226	1 pCi/L.
Radium 228	1 pCi/L.
Uranium	1 microgram/L

(b) To determine compliance with Section H(4) above, the detection limits shall not exceed the concentrations listed in Table C to this paragraph.

TABLE C: DETECTION LIMITS FOR MAN-MADE BETA PARTICLES AND PHOTON EMITTERS

Contaminant	Detection limit
Tritium	1,000 pCi/l
Strontium-89	10 pCi/l
Strontium - 90	2 pCi/l
Iodine-131	1 pCi/l
Cesium-134	10 pCi/l
Gross Beta	4 pCi/l
Other radionuclides	1/10 of the applicable limit

(4) To judge compliance with the maximum contaminant levels listed in Section H above, averages of data shall be used and shall be rounded to the same number of significant figures as the maximum contaminant level for the substance in question.

L. [Reserved]

M. [Reserved]

N. Maximum Contaminant Levels for Volatile Synthetic Organic Chemicals (VOCs).

(1) The maximum contaminant levels for volatile synthetic organic chemicals (VOCs) apply to all public water systems.

(2) The maximum contaminant levels for volatile synthetic organic chemicals (VOCs) are as follows:

	Contaminant	MCL (mg/l)
(a)	Vinyl chloride	0.002
(b)	Benzene	0.005
(c)	Carbon tetrachloride	0.005
(d)	1,2-Dichloroethane	0.005
(e)	Trichloroethylene	0.005
(f)	para-Dichlorobenzene	0.075
(g)	1,1,-Dichloroethylene	0.007
(h)	1,1,1-Trichloroethane	0.2
(i)	cis-1,2-Dichloroethylene	0.07
(j)	1,2-Dichloropropane	0.005
(k)	Ethylbenzene	0.7

	Contaminant	MCL (mg/l)
(l)	Monochlorobenzene	0.1
(m)	o-Dichlorobenzene	0.6
(n)	Styrene	0.1
(o)	Tetrachloroethylene	0.005
(p)	Toluene	1
(q)	trans-1,2-Dichloroethylene	0.1
(r)	Xylenes (total)	10
(s)	Dichloromethane	0.005
(t)	1,2,4-Trichlorobenzene	0.07
(u)	1,1,2-Trichloroethane	0.005

O. VOC Monitoring, Sampling and Analytical Requirements

(1) This section shall apply to community and non-transient non-community water systems.

(2) Beginning with the initial compliance period analysis of the contaminants listed in Section N(2) above, for the purpose of determining compliance with the maximum contaminant level shall be conducted as follows:

(a) Groundwater systems shall take a minimum of one (1) sample at every entry point to the distribution system which is representative of each well after treatment (hereafter called a sampling point). Each sample must be taken at the same sampling point unless conditions make another sampling point more representative of each source or treatment plant.

(b) Surface water systems (or combined surface/ground) shall take a minimum of one (1) sample at points in the distribution system that are representative of each source or at each entry point to the distribution system after treatment (hereafter called a sampling point). Each sample must be taken at the same sampling point unless conditions make another sampling point more representative of each source, treatment plant, or within the distribution system.

(c) If the system draws water from more than one (1) source and the sources are combined before distribution, the system must sample at an entry point to the distribution system during periods of normal operating conditions (i.e., when water representative of all sources is being used).

(d) Each community and non-transient non-community water system shall take four consecutive quarterly samples for each contaminant listed in Section N(2)(b) through (u) above, during each compliance period beginning in the initial compliance period.

(e) If the initial monitoring for contaminants listed in Section N(2)(a) through (h) and the monitoring for the contaminants listed in Section N(2)(i) through (u) as allowed in paragraph (2)(r) of this section, has been completed by December 31, 1992, and the system did not detect any contaminant listed in Section N(2) above, then each ground and surface water system shall take one (1) sample annually beginning with the initial compliance period.

(f) After a minimum of three (3) years of annual sampling, the Department may allow groundwater systems with no previous detection of any contaminant listed in Section N(2) above, to take one (1) sample during each compliance period.

(g) Each community and non-transient non-community ground water system which does not detect a contaminant listed in Section N(2) above, may apply to the Department for a waiver from the requirement of paragraphs (4)(e) and (4)(f) of this section after completing the initial monitoring. (For the purposes of this section, detection is defined as 0.0005 mg/l.) A waiver shall be effective for no more than six (6) years (two compliance periods). The Department may also issue waivers to small systems for the initial round of monitoring for 1,2,4-trichlorobenzene.

(h) The Department may grant a waiver after evaluating the following factor(s):

(i) Knowledge of previous use (including transport, storage, or disposal) of the contaminant within the watershed or zone of influence of the system. If a determination by the Department reveals no previous use of the contaminant within the watershed or zone of influence, a waiver may be granted.

(ii) If previous use of the contaminant is unknown or it has been used previously, then the following factors shall be used to determine whether a waiver is granted.

(A) Previous analytical results.

(B) The proximity of the system to a potential point or non-point source of contamination. Point sources include spills and leaks of chemicals at or near a water treatment facility or at manufacturing, distribution, or storage facilities, or from hazardous and municipal waste landfills and other waste handling or treatment facilities.

(C) The environmental persistence and transport of the contaminants.

(D) The number of persons served by the public water system and the proximity of a smaller system to a larger system.

(E) How well the water source is protected against contamination such as whether it is a surface or groundwater system. Groundwater systems must consider factors such as depth of the well, the type of soil, and wellhead protection. Surface water systems must consider watershed protection.

(i) As a condition of the waiver a groundwater system must take one (1) sample at each sampling point during the time the waiver is effective (i.e., one sample during two compliance periods or six years) and update its vulnerability assessment considering the factors listed in paragraph (2)(h) of this section. Based on this vulnerability assessment the Department must reconfirm that the system is non-vulnerable. If the Department does not make this reconfirmation within three (3) years of the initial determination, then the waiver is invalidated and the system is required to sample annually as specified in paragraph (e) of this section.

(j) Each community and non-transient non-community surface water system which does not detect a contaminant listed in Section N(2) above may apply to the Department for a waiver from the requirements of paragraph (4)(e) of this section after completing the initial monitoring. Composite samples from a maximum of five sampling points are allowed, provided that the detection limit of the method used for analysis is less than one-fifth of the MCL. Systems meeting this criteria must be determined by the Department to be non-vulnerable based upon a vulnerability assessment during each compliance period. Each system receiving a waiver shall sample at the frequency specified by the Department (if any).

(k) If a contaminant listed in Section N (2)(b) through (u) above, is detected at a level exceeding 0.0005 mg/l in any sample, then:

(l) Systems which violate the requirements of Section N(2) above, as determined by paragraph (2)(o) of this section must monitor quarterly. After a minimum of four (4) consecutive quarterly samples which shows the system is in compliance as specified in paragraph (2)(o) of this section, the system and the Department determines that the system is reliably and consistently below the maximum contaminant level, the system may monitor at the frequency and time specified in paragraph (4)(k)(iii) of this section.

(m) The Department may require a confirmation sample for positive or negative results. If a confirmation sample is required by the Department, the result must be averaged with the first sampling result and the average is used for the compliance determination as specified by paragraph (2)(o) of this section. The Department has the discretion to delete results of obvious sampling errors from this calculation.

(n) The Department may reduce the total number of samples a system must analyze by allowing the use of compositing. Composite samples from a maximum of five sampling points are allowed, provided that the detection limit of the method used for analysis is less than one-fifth of the MCL. Compositing of samples must be done in the laboratory and analyzed within fourteen (14) days of sample collection.

(i) If the concentration in the composite sample is 0.0005 mg/l for any contaminant listed in Section N(2) above, then a follow-up sample must be taken within fourteen (14) days at each sampling point included in the composite, and be analyzed for that contaminant.

(ii) If duplicates of the original sample taken from each sampling point used in the composite are available, the system may use these instead of resampling. The duplicate must be analyzed and the results reported to the Department within fourteen (14) days of collection.

(iii) If the population served by the system is greater than 3,300 persons, then compositing may only be permitted by the State at sampling points within a single system. In systems

serving 3,300 persons, the Department may permit compositing among different systems provided the 5-sample limit is maintained.

(iv) Compositing samples prior to GC analysis.

(A) Add 5 ml or equal larger amounts of each sample (up to 5 samples are allowed) to a 25 ml glass syringe. Special precautions must be made to maintain zero headspace in the syringe.

(B) The samples must be cooled at 4°C during this step to minimize volatilization losses.

(C) Mix well and draw out a 5-ml aliquot for analysis.

(D) Follow sample introduction, purging, and desorption steps described in the method.

(E) If less than five samples are used for compositing, a proportionately small syringe may be used.

(v) Compositing samples prior to GC/MS analysis.

(A) Inject 5-ml or equal larger amounts of each aqueous sample (up to 5 samples are allowed) into a 25-ml purging device using the sample introduction technique described in the method.

(B) The total volume of the sample in the purging device must be 25 ml.

(C) Purge and desorb as described in the method.

(o) Compliance with Section N(2) above, shall be determined based on the analytical results obtained at each sampling point. If one sampling point is in violation of an MCL, the system is in violation of the MCL.

(i) For systems monitoring more than once per year, compliance with the mcl is determined by a running annual average at each sampling point.

(ii) Systems monitoring annually or less frequently whose sample result exceeds the MCL must begin quarterly sampling. The system will not be considered in violation of the MCL until it has completed one year of quarterly sampling.

(iii) If any sample result will cause the running annual average to exceed the MCL at any sampling point, the system is out of compliance with the MCL immediately.

(iv) If a system fails to collect the required number of samples, compliance will be based on the total number of samples collected.

(v) If a sample result is less than the detection limit, zero will be used to calculate the annual average.

(p) Analysis for the contaminants listed in Section N(2) above, shall be conducted using EPA-approved methods listed in 40 CFR 141.

(q) Analysis under this section shall only be conducted by laboratories that are certified by the Department.

(r) The Department may allow the use of monitoring data collected after January 1, 1988, for purposes of initial monitoring compliance. If the data are generally consistent with the other requirements in this section, the Department may use those data (i.e., a single sample rather than four quarterly samples) to satisfy the initial monitoring requirement of paragraph (2)(d) of this section. Systems which use grandfathered samples and did not detect any contaminant listed in Section N(2)(b) through (u) above shall begin monitoring annually in accordance with paragraph (2)(e) of this section beginning with the initial compliance period.

(s) The Department may increase required monitoring where necessary to detect variations within the system.

(t) Each public water system shall monitor at the time designated by the Department within each compliance period.

(u) All new systems or systems that use a new source of water that begin operation after January 22, 2004 must demonstrate compliance with the MCL within a period of time specified by the Department. The system must also comply with the initial sampling frequencies specified by the Department to ensure a system can demonstrate compliance with the MCL. Routine and

increased monitoring frequencies shall be conducted in accordance with the requirements in this section.

(3) If a community or a non-transient non-community water system fails to comply with an applicable VOC MCL, that system shall give notice to the customers served by the system in accordance with the requirements of R.61-58.6.E.

P. Maximum Contaminant Levels for Disinfection Byproducts.

(1) Bromate and Chlorite

The maximum contaminant levels (MCLs) for bromate and chlorite are as follows:

Disinfection Byproduct	MCL (mg/L)
Bromate	0.010
Chlorite	1.0

(a) Compliance Dates.

Community water systems and non-transient non-community water systems that use a surface water source or a ground water source under the influence of surface water serving 10,000 or more persons must comply with this section beginning January 1, 2002. Community water systems and non-community non-transient water systems that use a surface water source or a ground water source under the influence of surface water serving fewer than 10,000 persons and community water systems and non-community non-transient water systems using only ground water not under the direct influence of surface water must comply with this section beginning January 1, 2004.

(b) Best technology, treatment techniques, or other means available for achieving compliance with the maximum contaminant levels for bromate and chlorite identified in this section are specified in 40 CFR 141.64 (a)(2).

(2) TTHM and HAA5.

(a) Stage 1 DBP Rule Running Annual Average (RAA) compliance.

The maximum contaminant levels (MCLs) for TTHM and HAA5 are as follows:

Disinfection Byproduct	MCL (mg/L)
Total Trihalomethanes (TTHM)	0.080
Haloacetic Acids (five) (HAA5)	0.060

(i) Compliance dates. Subpart H systems serving 10,000 or more persons must comply with this paragraph (2)(a) beginning January 1, 2002. Subpart H systems serving fewer than 10,000 persons and systems using only ground water not under the direct influence of surface water must comply with this paragraph (2)(a) beginning January 1, 2004. All systems must comply with these MCLs until the date specified for Stage 2 DBP Rule compliance in R.61-58.15.B(2).

(ii) Best technology, treatment techniques, or other means available for achieving compliance with the maximum contaminant levels for TTHM and HAA5 identified in this section are specified in 40 CFR 141.64 (b)(1)(ii).

(b) Stage 2 DBP Rule Locational Running Annual Average (LRAA) compliance.

The maximum contaminant levels (MCLs) for TTHM and HAA5 are as follows:

Disinfection Byproduct	MCL (mg/L)
------------------------	------------

Total Trihalomethanes (TTHM)	0.080
Haloacetic Acids (five) (HAA5)	0.060

(i) Compliance dates. The MCLs for TTHM and HAA5 must be complied with as a locational running annual average at each monitoring location beginning the date specified in R.61-58.15.B(2).

(ii) Best technology, treatment techniques, or other means available for achieving compliance with the maximum contaminant levels for TTHM and HAA5 identified in this section are specified in 40 CFR 141.64 (b)(2)(ii), and 40 CFR 141.64 (b)(2)(iii).

Q. Maximum Residual Disinfectant Levels (MRDLs) for Disinfectants.

(1) Maximum residual disinfectant levels (MRDLs) are as follows:

Disinfectant Residual	MRDL (mg/L)
Chlorine	4.0 (as Cl ₂)
Chloramines	4.0 (as Cl ₂)
Chlorine dioxide	0.8 (as ClO ₂)

(2) Compliance dates.

(a) Community water systems and non-transient non-community water systems that use a surface water source or a ground water source under the influence of surface water serving 10,000 or more persons must comply with this section beginning January 1, 2002. Community water systems and non-community non-transient water systems that use a surface water source or a ground water source under the influence of surface water serving fewer than 10,000 persons and community water systems and non-community non-transient water systems using only ground water not under the direct influence of surface water must comply with this section beginning January 1, 2004.

(b) Transient non-community water systems that use a surface water source or a ground water source under the influence of surface water serving 10,000 or more persons and using chlorine dioxide as a disinfectant or oxidant must comply with the chlorine dioxide MRDL beginning January 1, 2002. Transient non-community water systems that use a surface water source or a ground water source under the influence of surface water systems serving fewer than 10,000 persons and using chlorine dioxide as a disinfectant or oxidant and transient non-community water systems using only ground water not under the direct influence of surface water and using chlorine dioxide as a disinfectant or oxidant must comply with the chlorine dioxide MRDL beginning January 1, 2004.

R. Secondary Maximum Contaminant Levels.

(1) The secondary maximum contaminant levels are applicable to all public water systems.

(2) The secondary maximum contaminant levels are as follows:

Contaminant	Level
Aluminum	0.05 to 0.2 mg/l
Chloride	250 mg/l
Color	15 color units
Copper	1 mg/l
Corrosivity	Noncorrosive
Fluoride	2.0 mg/l
Foaming agents	0.5 mg/l
Iron	0.3 mg/l
Manganese	0.05 m/gl
Odor	3 threshold odor number
pH	6.5 to 8.5 s.u.
Silver	0.1 mg/l
Sulfate	250 mg/l
Total Dissolved Solids (TDS)	500 mg/l

<u>Contaminant</u>	<u>Level</u>
Zinc	5 mg/l

(3) The Department may establish higher or lower levels which may be appropriate depending upon local conditions provided the supplier of water is able to demonstrate that use of the water will not adversely affect the public health and welfare. In evaluating the affect to the public health and welfare, the supplier of water may evaluate the unavailability of alternate water sources; the economic evaluation of necessary treatment or other compelling factors that may prevent compliance.

(4) Community water systems that exceed the secondary MCL for fluoride, as determined by the last single sample taken in accordance with the requirements of these regulations, shall send the notice described in paragraph (5) of this section, to: (1) all existing billing units, (2) all new billing units at the time service begins, and (3) the Department.

(5) The public notice that shall be used by systems which exceed the secondary MCL for fluoride shall contain the specific language outlined in R.61-58.6.E(8), and no additional language except as necessary to complete the notice.

S. Secondary Maximum Contaminant Levels Sampling and Analytical Requirements.

(1) This section shall apply only to community and non-community water systems which serve at least fifteen service connections or regularly serve an average of at least twenty- five individuals daily at least sixty (60) days out of the year.

(2) At the discretion of the Department any community or non-community water system may be required to monitor, in whole or in part, for secondary maximum contaminant levels listed in Section R(2) or for any other secondary standard designated by the Department.

(3) For the initial analyses required by paragraph (2) of this section, data for surface waters acquired within one (1) year prior to the effective date and data for groundwaters acquired within three (3) years prior to the effective date of this regulation may be substituted at the discretion of the Department. Analyses conducted to determine compliance with Section R above shall be made using EPA-approved methods listed in 40 CFR 141.

T. Special Monitoring for Inorganic and Organic Contaminants.

(1) All community and non-transient non-community water supply systems shall conduct special monitoring for the following contaminants. Systems serving 10,000 or fewer persons are not required to monitor for the contaminants in the section after December 31, 1998.

Chloroform	1,3-Dichloropropane
Bromodichloromethane	Chloromethane
Chlorodibromomethane	Bromomethane
Bromoform	1,2,3-Trichloropropane
Chlorobenzene	1,1,1,2-Tetrachloroethane
m-Dichlorobenzene	Chloroethane
2,2-Dichloropropane	1,1-Dichloropropene
o-Chlorotoluene	1,1-Dichloroethane
Bromobenzene	1,1,2,2-Tetrachloroethane
1,3-Dichloropropene	p-Chlorotoluene

(2) Monitoring for the organic compounds listed in paragraph (1) of this section, shall begin no later than the date specified below:

<u>Population Served</u>	<u>Initial Monitoring Date</u>
>10,000	No later than January 1, 1988
3,300-10,000	No later than January 1, 1989
<3,300	No later than January 1, 1991

(3) Surface water systems shall sample at points in the distribution system representative of each water source or at entry points to the distribution system after any application of treatment. The minimum number of samples is one year of quarterly samples per water source.

(4) Ground water systems shall sample at points of entry to the distribution system representative of each well after any application of treatment. The minimum number of samples is one (1) sample per entry point to the distribution system.

- (5) The Department may require confirmation samples for positive or negative results.
- (6) [Reserved]
- (7) Analysis under this section shall be conducted using EPA-approved methods listed in 40 CFR 141.
- (8) Analysis under this section shall only be performed by laboratories which are certified by the Department.
- (9) Public water systems may use monitoring data collected any time after January 1, 1983, to meet the requirements of paragraph (1) of this section, provided that the monitoring program was consistent with the requirements of this section. In addition, the results of EPA's Ground Water Supply Survey may be used in a similar manner for systems supplied by a single well.

(10) At the Department's discretion, community water systems and non-transient non-community water systems may be required to conduct special monitoring for the following contaminants:

1,2,4-Trimethylbenzene	p-Isopropyltoluene
1,2,4-Trichlorobenzene	Isopropylbenzene
1,2,3-Trichlorobenzene	Tert-butylbenzene
n-Propylbenzene	Sec-butylbenzene
n-Butylbenzene	Fluorotrichloromethane
Naphthalene	Dichlorodifluoromethane
Hexachlorobutadiene	Bromochloromethane
1,3,5-Trimethylbenzene	

(11) All community and non-transient non-community water systems shall repeat the monitoring required by this Section no less frequently than every five (5) years from the dates specified in paragraph (2) of this section.

(12) The Department or public water systems may composite up to five samples when monitoring for the organic contaminants in paragraphs (1) and (10) of this section.

(13) Monitoring of the contaminants listed in paragraphs (13)(k) and (l) of this section, shall be conducted as follows:

(a) Each community and non-transient, non-community water system shall take four consecutive quarterly samples at each sampling point for each contaminant listed in paragraph (13)(k) of this section and report the results to the Department. Monitoring must be completed by December 31, 1995.

(b) Each community and non-transient non-community water system shall take one sample at each sampling point for each contaminant listed in paragraph (13)(l) of this section and report the results to the Department. Monitoring must be completed by December 31, 1995.

(c) Each community and non-transient non-community water system may apply to the Department for a waiver from the requirements of paragraph (13)(a) and (b) of this section.

(d) The Department may grant a waiver for the requirement of paragraph (13)(a) of this section based on the criteria specified in Section E(7)(f) above. The Department may grant a waiver from the requirement of paragraph (13)(b) of this section if previous analytical results indicate contamination would not occur, provided this data was collected after January 1, 1990.

(e) Groundwater systems shall take a minimum of one (1) sample at every entry point to the distribution system which is representative of each well after treatment (hereafter called a sampling point). Each sample must be taken at the same sampling point unless conditions make another sampling point more representative of each source or treatment plant.

(f) Surface water systems shall take a minimum of one (1) sample at points in the distribution system that are representative of each source or at each entry point to the distribution system after treatment (hereafter called a sampling point). Each sample must be taken at the same sampling point unless conditions make another sampling point more representative of each source or treatment plant. [Note: For purposes of this paragraph, surface water systems include systems with a combination of surface and ground sources.]

(g) If the system draws water from more than one (1) source and the sources are combined before distribution, the system must sample at an entry point to the distribution system during

periods of normal operating conditions (i.e., when water representative of all sources is being used).

(h) The Department may require a confirmation sample for positive or negative results.

(i) The Department may reduce the total number of samples a system must analyze by allowing the use of compositing. Composite samples from a maximum of five (5) sampling points are allowed. Compositing of samples must be done in the laboratory and the composite sample must be analyzed within fourteen (14) days of collection. If the population served by the system is greater than 3,300 persons, then compositing may only be permitted by the Department at sampling points within a single system. In systems serving 3,300 persons or less, the Department may permit compositing among different systems provided the 5-sample limit is maintained.

(j) Instead of performing the monitoring required by this section, a community water system or non-transient non-community water system serving fewer than 150 service connections may send a letter to the Department stating that the system is available for sampling. This letter must be sent to the Department by January 1, 1994. The system shall not send such samples to the Department, unless requested to do so by the Department.

(k) List of Unregulated Organic Contaminants:

<u>Organic Contaminants</u>	<u>EPA Analytical Method</u>
Aldicarb	531.1
Aldicarb sulfone	531.1
Aldicarb sulfoxide	531.1
Aldrin	505, 508, 525.1
Butachlor	507, 525.1
Carbaryl	531.1
Dicamba	515.1
Dieldrin	505, 508, 525.1
3-Hydroxycarbofuran	531.1
Methomyl	531.1
Metolachlor	507, 525.1
Metribuzin	507, 525.1
Propachlor	508, 525.1

(l) List of Unregulated Inorganic Contaminants:

<u>Inorganic Contaminant</u>	<u>EPA Analytical Method</u>
Sulfate	Colorimetric

(14) The owner or operator of a community or non-transient non-community water system that is required to monitor in accordance with this section shall send a copy of the results of such monitoring within thirty (30) days of receipt, and a copy of any public notice under paragraph (15) of this section, to the Department.

(15) The owner or operator shall notify the persons served by the system of the availability of the results of sampling conducted in accordance with this section by including a notice in the first set of water bills issued by the system after the receipt of the results or written notice within three (3) months. The notice shall identify a person and supply the telephone number to contact for information on the monitoring results. For surface water systems, public notification is required only after the first quarter's monitoring and must include a statement that additional monitoring will be conducted for three (3) more quarters with the results available upon request.

U. Special Monitoring for Sodium.

(1) Suppliers of water for community public water systems shall collect and analyze one (1) sample per plant at the entry point of the distribution system for the determination of sodium concentration levels; samples must be collected and analyzed annually for systems utilizing surface water sources in whole or in part, and at least every three (3) years for systems utilizing solely ground water sources. The minimum number of samples required to be taken by the system shall be based on the number of treatment plants used by the system, except that multiple wells drawing raw water from a single aquifer may, with the Department's approval, be considered one (1) treatment plant for determining

the minimum number of samples. The supplier of water may be required by the Department to collect and analyze water samples for sodium more frequently in locations where the sodium content is variable.

(2) The supplier of water shall report to the Department the results of the analyses for sodium within the first ten (10) days of the month following the month in which the sample results were received or within the first ten (10) days following the end of the required monitoring period as stipulated by the Department, whichever of these is first. If more than annual sampling is required the supplier shall report the average sodium concentration within ten (10) days of the month following the month in which the analytical results of the last sample used for the annual average was received.

(3) The supplier of water shall notify the appropriate local public health officials of the sodium levels in the water by written notice by direct mail within three (3) months after receiving the results of analyses. Within ten (10) days after notifying the local public health officials, the supplier of water shall forward a copy of such written notice to the Department. The supplier of water is not required to notify local public health officials where the Department provides such notices.

(4) Analysis for sodium shall be conducted using EPA-approved methods listed in 40 CFR 141.

V. Special Monitoring for Corrosivity Characteristics.

(1)–(3) [Reserved]

(4) The supplier of water for applicable community water systems shall identify and report to the Department whether the following construction materials are present in their distribution system:

- (a) Lead from piping, solder, caulking, interior lining of distribution mains, alloys and home plumbing.
- (b) Copper from piping and alloys, service lines and home plumbing.
- (c) Galvanized piping, service lines and home plumbing.
- (d) Ferrous piping materials such as cast iron and steel.
- (e) Vinyl lined asbestos cement pipe.
- (f) Coal tar lined pipes and tanks.
- (g) Asbestos cement pipe.

W. Special Monitoring and Notification Requirements.

The Department shall perform such monitoring as is necessary to insure the quality and integrity of results of tests, measurements, or analyses reported by the supplier of water. Should such monitoring by the Department indicate a violation of the maximum contaminant levels, or the presence of any contaminant at levels considered to be a real or potential threat to the public's health, the Department at its discretion may notify the public or require the supplier of water to notify the public pursuant to R.61-58.6.E, or other method deemed appropriate by the Department and initiate the necessary action to eliminate the violation or contaminant.

X. Monitoring of Consecutive Public Water Systems.

When a public water system supplies water to one or more other public water systems, the Department may modify the monitoring requirements imposed by this regulation to the extent that the interconnection of the systems justifies treating them as a single system for monitoring purposes. Any modified monitoring shall be conducted pursuant to a schedule specified by the Department and concurred in by the Administrator.

Y. Criteria and Procedures for Public Water Systems using Point-of-Entry Devices.

(1) Public water systems may use point-of-entry devices to comply with maximum contaminant levels only if they meet the requirements of this section.

(2) It is the responsibility of the public water system to operate and maintain the point-of-entry treatment system.

(3) The public water system must develop and obtain Department approval for a monitoring plan before point-of-entry devices are installed for compliance. Under the plan approved by the Department, point-of-entry devices must provide health protection equivalent to central water treatment. "Equivalent" means that the water would meet all State primary drinking water

regulations and would be of acceptable quality similar to water distributed by a well-operated central treatment plant. In addition to the VOCs, monitoring must include physical measurements and observations such as total flow treated and mechanical condition of the treatment equipment.

(4) The public water system must properly apply effective technology under a plan approved by the Department and must maintain the microbiological safety of the water.

(a) The public water system must provide adequate certification of performance, field testing, and, if not included in the certification process, a rigorous engineering design review of the point-of-entry devices.

(b) The design and application of the point-of-entry devices must consider the tendency for an increase in heterotrophic bacteria concentrations in water treated with activated carbon. It may be necessary to use frequent backwashing, post-contactor disinfection, and Heterotrophic Plate Count monitoring to ensure that the microbiological safety of the water is not compromised.

(5) The public water system must protect all consumers. Every building connected to the system must have a point-of-entry device installed, maintained, and adequately monitored. The public water system must assure that every building is subject to treatment and monitoring, and that the rights and responsibilities of the public water system customer convey with title upon sale of property.

Z. Use of Other Non-Centralized Treatment Devices.

Public water systems shall not use bottled water or point-of-use devices to achieve compliance with an established maximum contaminant level. Bottled water or point-of-use devices may be used on a temporary basis to avoid an unreasonable risk to health.

AA. Treatment Techniques.

(1) This section establishes criteria and requirements for treatment techniques in lieu of maximum contaminant levels for specified contaminants. This section applies to all public water systems.

(2) Treatment techniques for acrylamide and epichlorohydrin. Each public water system must certify annually in writing to the Department (using third party or manufacturer's certification) that when acrylamide and epichlorohydrin are used in drinking water systems, the combination (or product) of dose and monomer level does not exceed the levels specified as follows:

Acrylamide = 0.05% dosed at 1 ppm (or equivalent)

Epichlorohydrin = 0.01% dosed at 20 ppm (or equivalent)

Certifications can rely on manufacturers or third parties, as approved by the Department.

BB. Approved Laboratories.

For the purpose of determining compliance with R.61-58.5.B through R.61-58.5.V, R.61-58.5.CC, R.61-58.10.F, R.61-58.11.D, and R.61-58.16.E, samples may be considered only if they have been analyzed by a laboratory approved by the Department, except that measurements for turbidity may be performed by a properly certified water treatment plant operator.

CC. Alternative Analytical Techniques.

With express written permission of the Department, concurred in by the Administrator, an alternative analytical technique may be employed. An alternative technique shall be acceptable only if it is substantially equivalent to the prescribed test in both precision and accuracy as it relates to the determination of compliance with any maximum contaminant level. The use of the alternative analytical technique shall not decrease the frequency of monitoring required by this regulation.

DD. and EE. [Deleted]

HISTORY: Amended by State Register Volume 12, Issue No. 11, eff November 25, 1988; State Register Volume 17, Issue No. 8, eff August 27, 1993; State Register Volume 17, Issue No. 12, eff December 24, 1993; State Register Volume 18, Issue No. 11, eff November 25, 1994; State Register Volume 19, Issue No. 7, eff July 28, 1995; State Register Volume 22, Issue No. 6, Part 2, eff June 26, 1998; State Register Volume 24, Issue No. 2, eff February 25, 2000; State Register Volume 25, Issue No. 9, eff September 28, 2001; State Register Volume 26, Issue No. 12, eff December 27, 2002; State Register Volume 27, Issue No. 9, eff September 26, 2003; State Register Volume 28, Issue No. 1, eff January 23, 2004; State Register Volume 30, Issue No. 10, eff October 27, 2006; State Register Volume 32, Issue No. 4, eff April 25, 2008; State Register Volume 38, Issue No. 9, Doc. No. 4469, eff September 26, 2014.

61–58.6. Reports, Record Retention and Public Notification.

Table of Contents

- A. Applicability
- B. Reporting Requirements
- C. Reports to Be Submitted
- D. Record Keeping
- E. Public Notification of Drinking Water Violations

A. Applicability.

This regulation specifies the information public water supplies are required to report to the Department; the information they are required to retain; and the conditions and procedure for making public notification of a violation. This regulation shall apply to each public water system, unless the public water system meets all of the following conditions:

- (1) Consists only of distribution and storage facilities (and does not have any collection and treatment facilities);
- (2) Obtains all of its water from, but is not owned or operated by, a public water system to which such regulations apply;
- (3) Does not sell water to any person; and
- (4) Is not a carrier which conveys passengers in interstate commerce.

B. Reporting Requirements.

(1) Except where a shorter reporting period is specified in this regulation, the supplier of water shall report to the Department the results of any test, measurement or analysis required to be made by the primary drinking water regulation within ten calendar days following the end of the month in which the result is received or within ten calendar days following the end of the monitoring period specified by the Department, whichever of these is shortest. Such report shall be in form established by the Department.

(2) If the result of an analysis made pursuant to the requirements of R.61–58.5, Maximum Contaminant Levels in Drinking Water, indicates that the level of any contaminant listed in said regulation exceeds the maximum contaminant level, the supplier of water shall report these findings to the Department within seven days of receiving the results.

(3) Except where a different reporting period is specified in these regulations, the supplier of water shall report to the Department within 48 hours the failure to comply with any national primary drinking water regulations (including failure to comply with monitoring requirements) as set forth in these regulations.

(4) The supplier of water is not required to report analytical results to the Department in cases where a State Laboratory performs the analysis and reports the results to the Department.

(5) Certification and notification of public notice issued

(a) The public water system, within ten (10) days of completing the public notification requirements under Section E below for the initial public notice and any repeat notices, must submit to the Department a certification that it has fully complied with the public notification regulations. For Tier 2 and 3 notices, the public water system must include with this certification a representative copy of each type of notice distributed, published, posted, and made available to the persons served by the system and to the media.

(b) For Tier 1 notices for a lead action level exceedance, public water systems must provide a copy of any Tier 1 notice to the Administrator and the head of the Department as soon as practicable, but not later than twenty-four (24) hours after the public water system learns of the violation or exceedance.

(6) The public water system shall submit to the Department, when requested, within the time stated in the request, copies of any records required to be maintained under R.61–58.6.D or copies

of any documents then in existence which the Department or the EPA Administrator is entitled to inspect pursuant to the authority of section 1445 of the Safe Drinking Water Act or the equivalent provisions of State law.

C. Reports To Be Submitted.

All reports listed below are to be on a form or in a format (written or electronic) approved by the Department.

(1) By the tenth calendar day of each month, the supplier of water for each surface water treatment plant shall complete and submit to the Department, as a minimum, the following reports for the previous month:

- (a) Surface Water Supply Monthly Operation Report
- (b) Bacteriological Summary Analysis Report
- (c) Turbidity Summary Analysis Report

(2) By the tenth calendar day of each month, the supplier of water, who operates a groundwater treatment plant that provides water to a community water system serving at least fifteen service connections or twenty-five individuals on a continuous basis, shall complete and submit to the Department, as a minimum, the following reports for the previous month:

- (a) Ground Water Supply Monthly Operation Report
- (b) Bacteriological Summary Analysis Report (if eight or more bacteriological samples are collected each month)

(3) By the tenth calendar day of each month, the supplier of water, who uses wells as a sole source of supply for a community water system serving at least fifteen service connections or twenty-five individuals on a continuous basis, and does not treat the water, shall complete and submit to the Department, as a minimum, the following reports for the previous month:

- (a) Bacteriological Summary Analysis Report (if eight or more bacteriological samples are collected each month)
- (b) Bacteriological Analysis Report (if seven or less bacteriological samples are collected each month)

(c) The total amount of water pumped from the wells each month and the total volume of water delivered to the customers each month, if the information is available

(4) By the tenth calendar day of each month, the supplier of water, who obtains water from another public water supply and provides it to a community water system serving at least fifteen service connections or twenty-five individuals on a continuous basis, shall complete and submit to the Department, as a minimum, the following reports for the previous month:

- (a) Bacteriological Summary Analysis Report (if eight or more bacteriological samples are collected each month)
- (b) Bacteriological Analysis Report (if seven or less bacteriological samples are collected each month)

(c) The total amount of water purchased each month and the total amount of water delivered to the customers each month, where required by the Department

(5) By the tenth calendar day of each month, the supplier of water, who operates a groundwater treatment plant using treatment processes other than the addition of chlorine or corrosion inhibitor or the adjustment of pH, and which provides water to a non-community water system serving at least fifteen service connections or an average of at least twenty-five individuals daily at least sixty days out of the year, shall complete and submit to the Department, as a minimum, the following reports for the previous month:

- (a) Ground Water Supply Monthly Operation Report
- (b) Bacteriological Summary Analysis Report (if eight or more bacteriological samples are collected each month)
- (c) Bacteriological Analysis Report (if seven or less bacteriological samples are collected each month)

(6) Based on complaints received, the results of chemical, or bacteriological testing or the findings of sanitary surveys, the Department may require the supplier of water for any community or non-community water system not described in subsections (1) through (5) above to submit any necessary reports or monitoring data at a frequency established by the Department.

(7) If a water level measuring device has been installed in a well serving a public water supply, the supplier of water shall measure and record the static and pumping water levels on a quarterly basis. The results shall be forwarded to the Department by the tenth calendar day of the following month.

(8) The supplier of water for a community water system that serves more than one hundred service connections shall monitor the operating pressure in the distribution system annually and shall record the date and location where each pressure test was made and the pressure in pounds per square inch. A copy of the results shall be made available to the Department upon request. Records of these results shall be maintained for a period not less than three years.

(9) In the event the Department finds it necessary to require a supplier of water to monitor for chemical parameters on a schedule more stringent than required for routine monitoring, the supplier of water shall submit the monitoring data by the tenth calendar day of the month following the month in which the data was received.

D. Record Keeping

(1) Any supplier of water subject to the provisions of this regulation and R.61-58.5, Maximum Contaminant Levels in Drinking Water, shall retain on the premises at a convenient location near the premises all appropriate records, and make them available for inspection by the Department and the public upon request.

(2) These records shall include the following:

(a) Records of microbiological analyses and turbidity analyses made pursuant to the State Primary Drinking Water Regulation: R.61-58 shall be kept for not less than five (5) years. Records of chemical analyses made pursuant to State Primary Drinking Water Regulation: R.61-58 shall be kept for not less than ten years. Actual laboratory reports may be kept, or data may be transferred to tabular summaries, provided that the following information is included:

(i) The date, place, and time of sampling, and the name of the person who collected the sample.

(ii) Identification of the sample as to whether it was a routine distribution system sample, check sample, raw or process water sample or other special purpose sample.

(iii) Date of analysis.

(iv) Laboratory and person responsible for performing analysis.

(v) The analytical technique or method used.

(vi) The results of the analysis.

(b) Records of action taken by the supplier of water to correct violation of regulations, shall be kept for a period not less than three years after the last action with respect to the particular violation involved.

(c) Copies of any written reports, summaries, or communications relating to sanitary surveys or operational inspections of the public water supply conducted by the supplier of water, by a private consultant, or by any local, state, or federal agency, shall be kept for a period not less than ten years after completion of the sanitary survey involved.

(d) Records concerning a variance or exemption granted to the public water supply shall be kept for a period ending not less than five years following the expiration of such variance or exemption.

(e) Copies of public notices issued pursuant to Section E below and certifications made to the Department pursuant to the provisions of this regulation must be kept for three (3) years after issuance.

(f) Copies of monitoring plans developed pursuant to the State Primary Drinking Water Regulation: R.61-58 shall be kept for the same period of time as the records of analyses taken under the plan are required to be kept under paragraph (a) of this section, except as specified elsewhere in this regulation.

E. Public Notification of Drinking Water Violations.

(1) General public notification requirements:

(a) Who must give public notice? Each owner or operator of a public water system (community water systems, non-transient non-community water systems, and transient non community water systems) must give notice for all violations of State Primary Drinking Water Regulations (SPDWR) and for other situations, as listed in Table 1. The term “SPDWR violations” is used in this regulation to include violations of the maximum contaminant level (MCL), maximum residual disinfection level (MRDL), treatment technique (TT), monitoring requirements, and testing procedures in this regulation. Appendix A to this regulation identifies the tier assignment for each specific violation or situation requiring a public notice.

TABLE 1: VIOLATION CATEGORIES AND OTHER SITUATIONS REQUIRING A PUBLIC NOTICE

(1) SPDWR violations:

- (i) Failure to comply with an applicable maximum contaminant level(MCL) or maximum residual disinfectant level (MRDL).
- (ii) Failure to comply with a prescribed treatment technique (TT).
- (iii) Failure to perform water quality monitoring, as required by the drinking water regulations.
- (iv) Failure to comply with testing procedures as prescribed by a drinking water regulation.

(2) Variance and exemptions under R.61–58.9:

- (i) Operation under a variance or an exemption.
- (ii) Failure to comply with the requirements of any schedule that has been set under a variance or exemption.

(3) Special public notices:

- (i) Occurrence of a waterborne disease outbreak or other waterborne emergency.
- (ii) Exceedance of the nitrate MCL by non-community water systems (NCWS), where granted permission by the Department under R.61–58.5.B(3).
- (iii) Exceedance of the secondary maximum contaminant level (SMCL) for fluoride.
- (iv) Availability of unregulated contaminant monitoring data.
- (v) Other violations and situations determined by the Department to require a public notice under this regulation, not already listed in Appendix A to this regulation.
- (vi) Exceedance of the lead action level.

(b) What type of public notice is required for each violation or situation? Public notice requirements are divided into three (3) tiers, to take into account the seriousness of the violation or situation and of any potential adverse health effects that may be involved. The public notice requirements for each violation or situation listed in Table 1 of this section are determined by the tier to which it is assigned. Table 2 of this section provides the definition of each tier. Appendix A to this regulation identifies the tier assignment for each specific violation or situation.

TABLE 2: DEFINITION OF PUBLIC NOTICE TIERS

- (1) Tier 1 public notice — required for SPDWR violations and situations with significant potential to have serious adverse effects on human health as a result of short-term exposure.
- (2) Tier 2 public notice — required for all other SPDWR violations and situations with potential to have serious adverse effects on human health.
- (3) Tier 3 public notice — required for all other SPDWR violations and situations not included in Tier 1 and Tier 2.

(c) *Who must be notified?*

(i) Each public water system must provide public notice to persons served by the water system, in accordance with this regulation. Public water systems that sell or otherwise provide drinking water to other public water systems (i.e., to consecutive systems) are required to give public notice to the owner or operator of the consecutive system; the consecutive system is responsible for providing public notice to the persons it serves.

(ii) If a public water system has a violation in a portion of the distribution system that is physically or hydraulically isolated from other parts of the distribution system, the Department may allow the system to limit distribution of the public notice to only persons served by that portion of the system which is out of compliance. Permission by the Department for limiting distribution of the notice must be granted in writing.

(iii) A copy of the notice must also be sent to the Department and the Administrator (as applicable) in accordance with the requirements of R.61-58.6.B(5).

(2) Tier 1 Public Notice: Form, Manner, and Frequency of Notice

(a) **Which violations or situations require a Tier 1 public notice?** Table 1 of this section lists the violation categories and other situations requiring a Tier 1 public notice. Appendix A to this regulation identifies the tier assignment for each specific violation or situation.

**TABLE 1: VIOLATION CATEGORIES AND OTHER SITUATIONS
REQUIRING A TIER 1 PUBLIC NOTICE**

(1) Violation of the MCL for total coliforms when fecal coliform or E. coli are present in the water distribution system (as specified in R.61-58.5.F(2)), or when the water system fails to test for fecal coliforms or E. coli when any repeat sample tests positive for coliform (as specified in R.61-58.5.G(5)), violation of the MCL for E. coli (as specified in R.61-58.5.F);

(2) Violation of the MCL for nitrate, nitrite, or total nitrate and nitrite, as defined in R.61-58.5.B, or when the water system fails to take a confirmation sample within 24 hours of the system's receipt of the first sample showing an exceedance of the nitrate or nitrite MCL, as specified in R.61-58.5.C(12)(b);

(3) Exceedance of the nitrate MCL by non-community water systems, where permitted to exceed the MCL by the Department under R.61-58.5.B(3), as required under paragraph (9) of this section;

(4) Violation of the MRDL for chlorine dioxide, as defined in R.61-58.5.Q(1), when one or more samples taken in the distribution system the day following an exceedance of the MRDL at the entrance of the distribution system exceed the MRDL, or when the water system does not take the required samples in the distribution system, as specified in R.61-58.13.D(3)(b)(i);

(5) Violation of the turbidity MCL under R.61-58.10(C), (E), (H), or (I), where the Department determines after consultation that a Tier 1 notice is required or where consultation does not take place within 24 hours after the system learns of the violation;

(6) Violation of the Surface Water Treatment Rule (SWTR), Interim Enhanced Surface Water Treatment Rule (IESWTR) or Long Term 1 Enhanced Surface Water Treatment Rule (LT1EWSTR) treatment technique requirement resulting from a single exceedance of the maximum allowable turbidity limit (as identified in Appendix A to this regulation), where the Department determines after consultation that a Tier 1 notice is required or where consultation does not take place within twenty-four (24) hours after the system learns of the violation;

(7) Occurrence of a waterborne disease outbreak, as defined in R.61-58(B)(174), or other waterborne emergency (such as a failure or significant interruption in key water treatment processes, a natural disaster that disrupts the water supply or distribution system, or a chemical spill or unexpected loading of possible pathogens into the source water that significantly increases the potential for drinking water contamination);

(8) Detection of E. coli, enterococci, or coliphage in source water samples as specified in R.61-58.16.E(1) or R.61-58.16.E(2).

(9) Other violations or situations with significant potential to have serious adverse effects on human health as a result of short-term exposure, as determined by the Department either in its regulations or on a case-by-case basis.

(10) Exceedance of the Action Level for lead as specified in R.61-58.11.B(3).

(b) *When is the Tier 1 public notice to be provided? What additional steps are required?* Public water systems must:

(i) Provide a public notice as soon as practical but no later than twenty-four (24) hours after the system learns of the violation;

(ii) Initiate consultation with the Department as soon as practical, but no later than twenty-four (24) hours after the public water system learns of the violation or situation, to determine additional public notice requirements; and

(iii) Comply with any additional public notification requirements (including any repeat notices or direction on the duration of the posted notices) that are established as a result of the consultation with the Department. Such requirements may include the timing, form, manner, frequency, and content of repeat notices (if any) and other actions designed to reach all persons served.

(c) *What is the form and manner of the public notice?* Public water systems must provide the notice within twenty-four (24) hours in a form and manner reasonably calculated to reach all persons served. The form and manner used by the public water system are to fit the specific situation, but must be designed to reach residential, transient, and non-transient users of the water system. In order to reach all persons served, water systems are to use, at a minimum, one or more of the following forms of delivery:

(i) Appropriate broadcast media (such as radio and television);

(ii) Posting of the notice in conspicuous locations throughout the area served by the water system;

(iii) Hand delivery of the notice to persons served by the water system; or

(iv) Another delivery method approved in writing by the Department.

(3) Tier 2 Public Notice: Form, Manner, and Frequency of Notice.

(a) Which violations or situations require a Tier 2 public notice? Table 1 of this section lists the violation categories and other situations requiring a Tier 2 public notice. Appendix A to this regulation identifies the tier assignment for each specific violation or situation.

**TABLE 1: VIOLATION CATEGORIES AND OTHER SITUATIONS
REQUIRING A TIER 2 PUBLIC NOTICE**

(1) All violations of the MCL, MRDL, and treatment technique requirements, except where a Tier 1 notice is required under paragraph (2)(a) of this section or where the Department determines that a Tier 1 notice is required;

(2) Violations of the monitoring and testing procedure requirements, where the Department determines that a Tier 2 rather than a Tier 3 public notice is required, taking into account potential health impacts and persistence of the violation;

(3) Failure to comply with the terms and conditions of any variance or exemption in place; and

(4) Failure to take corrective action or failure to maintain at least 4-log treatment of viruses (using inactivation, removal, or a Department approved combination of 4-log virus inactivation and removal) before or at the first customer under R.61-58.16.F(1).

(b) *When is the Tier 2 public notice to be provided?*

(i) Public water systems must provide the public notice as soon as practical, but no later than thirty (30) days after the system learns of the violation. If the public notice is posted, the notice must remain in place for as long as the violation or situation persists, but in no case for less than seven (7) days, even if the violation or situation is resolved. The Department may, in appropriate circumstances, allow additional time for the initial notice of up to three (3) months from the date the system learns of the violation. It is not appropriate for the Department to

grant an extension to the thirty (30) day deadline for any unresolved violation or to allow across-the-board extensions by rule or policy for other violations or situations requiring a Tier 2 public notice. Extensions granted by the Department must be in writing.

(ii) The public water system must repeat the notice every three (3) months as long as the violation or situation persists, unless the Department determines that appropriate circumstances warrant a different repeat notice frequency. In no circumstance may the repeat notice be given less frequently than once per year. It is not appropriate for the Department to allow less frequent repeat notice for an MCL or treatment technique violation under the Total Coliform Rule or the Revised Total Coliform Rule (R.61-58.17) or a treatment technique violation under the Surface Water Treatment Rule or Interim Enhanced Surface Water Treatment Rule. It is also not appropriate for the Department to allow through its rules or policies across-the-board reductions in the repeat notice frequency for other ongoing violations requiring a Tier 2 repeat notice. Department determinations allowing repeat notices to be given less frequently than once every three (3) months must be in writing.

(iii) For the turbidity violations specified in this paragraph, public water systems must consult with the Department as soon as practical but no later than twenty-four (24) hours after the public water system learns of the violation, to determine whether a Tier 1 public notice under paragraph (2)(a) of this section is required to protect public health. When consultation does not take place within the twenty-four (24) hour period, the water system must distribute a Tier 1 notice of the violation within the next twenty-four (24) hours (i.e., no later than forty-eight (48) hours after the system learns of the violation), following the requirements under paragraphs (b) and (c) of this section. Consultation with the Department is required for:

(A) Violation of the turbidity MCL under R.61-58.10(C), (E), (H), or (I); or

(B) Violation of the SWTR, IESWTR or LTIESWTR treatment technique requirement resulting from a single exceedance of the maximum allowable turbidity limit.

(c) *What is the form and manner of the Tier 2 public notice?* Public water systems must provide the initial public notice and any repeat notices in a form and manner that is reasonably calculated to reach persons served in the required time period. The form and manner of the public notice may vary based on the specific situation and type of water system, but it must at a minimum meet the following requirements:

(i) Unless directed otherwise by the Department in writing, community water systems must provide notice by:

(A) Mail or other direct delivery to each customer receiving a bill and to other service connections to which water is delivered by the public water system; and

(B) Any other method reasonably calculated to reach other persons regularly served by the system, if they would not normally be reached by the notice required in R.61-58.6.E(3)(c)(i)(A). Such persons may include those who do not pay water bills or do not have service connection addresses (e.g., house renters, apartment dwellers, university students, nursing home patients, prison inmates, etc.). Other methods may include: Publication in a local newspaper; delivery of multiple copies for distribution by customers that provide their drinking water to others (e.g., apartment building owners or large private employers); posting in public places served by the system or on the Internet; or delivery to community organizations.

(ii) Unless directed otherwise by the Department in writing, non-community water systems must provide notice by:

(A) Posting the notice in conspicuous locations throughout the distribution system frequented by persons served by the system, or by mail or direct delivery to each customer and service connection (where known); and

(B) Any other method reasonably calculated to reach other persons served by the system if they would not normally be reached by the notice required in R.61-58.6.E(3)(c)(ii)(A). Such persons may include those served who may not see a posted notice because the posted notice is not in a location they routinely pass by. Other methods may include: Publication in a local newspaper or newsletter distributed to customers; use of E-mail to notify employees or students; or, delivery of multiple copies in central locations (e.g., community centers).

(4) Tier 3 Public Notice: Form, Manner, and Frequency of Notice.

(a) **Which violations or situations require a Tier 3 public notice?** Table 1 of this section lists the violation categories and other situations requiring a Tier 3 public notice. Appendix A to this regulation identifies the tier assignment for each specific violation or situation.

**TABLE 1: VIOLATION CATEGORIES AND OTHER SITUATIONS
REQUIRING A TIER 3 PUBLIC NOTICE**

- (1) Monitoring violations under R.61-58.5, except where a Tier 1 notice is required under paragraph (2)(a) of this section or where the Department determines that a Tier 2 notice is required;
- (2) Failure to comply with a testing procedure established in R.61-58.5, except where a Tier 1 notice is required under paragraph (2)(a) of this section or where the Department determines that a Tier 2 notice is required;
- (3) Operation under a variance or an exemption granted under R.61-58.9;
- (4) Availability of unregulated contaminant monitoring results, as required under R.61-58.6.E(7);
- (5) Exceedance of the fluoride secondary maximum contaminant level (SMCL), as required under R.61-58.6.E(8); and
- (6) Reporting and Recordkeeping violations under R.61-58.17.

(b) *When is the Tier 3 public notice to be provided?*

(i) Public water systems must provide the public notice not later than one (1) year after the public water system learns of the violation or situation or begins operating under a variance or exemption. Following the initial notice, the public water system must repeat the notice annually for as long as the violation, variance, exemption, or other situation persists. If the public notice is posted, the notice must remain in place for as long as the violation, variance, exemption, or other situation persists, but in no case less than seven (7) days (even if the violation or situation is resolved).

(ii) Instead of individual Tier 3 public notices, a public water system may use an annual report detailing all violations and situations that occurred during the previous twelve months, as long as the timing requirements of paragraph (b)(i) of this section are met.

(c) *What is the form and manner of the Tier 3 public notice?* Public water systems must provide the initial notice and any repeat notices in a form and manner that is reasonably calculated to reach persons served in the required time period. The form and manner of the public notice may vary based on the specific situation and type of water system, but it must at a minimum meet the following requirements:

(i) Unless directed otherwise by the Department in writing, community water systems must provide notice by:

(A) Mail or other direct delivery to each customer receiving a bill and to other service connections to which water is delivered by the public water system; and

(B) Any other method reasonably calculated to reach other persons regularly served by the system, if they would not normally be reached by the notice required in paragraph (c)(i)(A) of this section. Such persons may include those who do not pay water bills or do not have service connection addresses (e.g., house renters, apartment dwellers, university students, nursing home patients, prison inmates, etc.). Other methods may include: Publication in a local newspaper; delivery of multiple copies for distribution by customers that provide their drinking water to others (e.g., apartment building owners or large private employers); posting in public places or on the Internet; or delivery to community organizations.

(ii) Unless directed otherwise by the Department in writing, non-community water systems must provide notice by:

(A) Posting the notice in conspicuous locations throughout the distribution system frequented by persons served by the system, or by mail or direct delivery to each customer and service connection (where known); and

(B) Any other method reasonably calculated to reach other persons served by the system, if they would not normally be reached by the notice required in paragraph (c)(ii)(A) of this section. Such persons may include those who may not see a posted notice because the notice is not in a location they routinely pass by. Other methods may include: Publication in a local newspaper or newsletter distributed to customers; use of E-mail to notify employees or students; or, delivery of multiple copies in central locations (e.g., community centers).

(d) *In what situations may the Consumer Confidence Report be used to meet the Tier 3 public notice requirements?* For community water systems, the Consumer Confidence Report (CCR) required under R.61-58.12 of this regulation may be used as a vehicle for the initial Tier 3 public notice and all required repeat notices, as long as:

- (i) The CCR is provided to persons served no later than twelve (12) months after the system learns of the violation or situation as required under paragraph (4)(b) of this section;
- (ii) The Tier 3 notice contained in the CCR follows the content requirements under paragraph (5) of this section; and
- (iii) The CCR is distributed following the delivery requirements under paragraph (4)(c) of this section.

(5) Content of the Public Notice.

(a) *What elements must be included in the public notice for violations of State Primary Drinking Water Regulations (SPDWR) or other situations requiring a public notice?* When a public water system violates a SPDWR or has a situation requiring public notification, each public notice must include the following elements:

- (i) A description of the violation or situation, including the contaminant(s) of concern, and (as applicable) the contaminant level(s);
- (ii) When the violation or situation occurred;
- (iii) Any potential adverse health effects from the violation or situation, including the standard language under paragraphs (d)(i) or (d)(ii) of this section, whichever is applicable;
- (iv) The population at risk, including subpopulations particularly vulnerable if exposed to the contaminant in their drinking water;
- (v) Whether alternative water supplies should be used;
- (vi) What actions consumers should take, including when they should seek medical help, if known;
- (vii) What the system is doing to correct the violation or situation;
- (viii) When the water system expects to return to compliance or resolve the situation;
- (ix) The name, business address, and phone number of the water system owner, operator, or designee of the public water system as a source of additional information concerning the notice; and
- (x) A statement to encourage the notice recipient to distribute the public notice to other persons served, using the standard language under paragraph (d)(iii) of this section, where applicable.

(b) *What elements must be included in the public notice for public water systems operating under a variance or exemption?*

- (i) If a public water system has been granted a variance or an exemption, the public notice must contain:
 - (A) An explanation of the reasons for the variance or exemption;
 - (B) The date on which the variance or exemption was issued;
 - (C) A brief status report on the steps the system is taking to install treatment, find alternative sources of water, or otherwise comply with the terms and schedules of the variance or exemption; and
 - (D) A notice of any opportunity for public input in the review of the variance or exemption.

(ii) If a public water system violates the conditions of a variance or exemption, the public notice must contain the ten elements listed in paragraph (a) of this section.

(c) *How is the public notice to be presented?*

(i) Each public notice required by this section:

(A) Must be displayed in a conspicuous way when printed or posted;

(B) Must not contain overly technical language or very small print;

(C) Must not be formatted in a way that defeats the purpose of the notice;

(D) Must not contain language which nullifies the purpose of the notice.

(ii) Each public notice required by this section must comply with multilingual requirements, as follows:

(A) For public water systems serving a large proportion of non-English speaking consumers, as determined by the Department, the public notice must contain information in the appropriate language(s) regarding the importance of the notice or contain a telephone number or address where persons served may contact the water system to obtain a translated copy of the notice or to request assistance in the appropriate language.

(B) In cases where the Department has not determined what constitutes a large proportion of non-English speaking consumers, the public water system must include in the public notice the same information as in paragraph (c)(ii)(A) of this section, where appropriate to reach a large proportion of non-English speaking persons served by the water system.

(d) *What standard language must public water systems include in their public notice?* Public water systems are required to include the following standard language in their public notice:

(i) Standard health effects language for MCL or MRDL violations, treatment technique violations, and violations of the condition of a variance or exemption. Public water systems must include in each public notice the health effects language specified in Appendix B to this regulation corresponding to each MCL, MRDL, and treatment technique violation listed in Appendix A to this regulation, and for each violation of a condition of a variance or exemption.

(ii) Standard language for monitoring and testing procedure violations. Public water systems must include the following language in their notice, including the language necessary to fill in the blanks, for all monitoring and testing procedure violations listed in Appendix A to this regulation:

"We are required to monitor your drinking water for specific contaminants on a regular basis. Results of regular monitoring are an indicator of whether or not your drinking water meets health standards. During [compliance period], we "did not monitor or test" or "did not complete all monitoring or testing" for [contaminant(s)], and therefore cannot be sure of the quality of your drinking water during that time."

(iii) Standard language to encourage the distribution of the public notice to all persons served. Public water systems must include in their notice the following language (where applicable): Please share this information with all the other people who drink this water, especially those who may not have received this notice directly (for example, people in apartments, nursing homes, schools, and businesses). You can do this by posting this notice in a public place or distributing copies by hand or mail.

(6) Notice to New Billing Units or New Customers.

(a) *What is the requirement for community water systems?* Community water systems must give a copy of the most recent public notice for any continuing violation, the existence of a variance or exemption, or other ongoing situations requiring a public notice to all new billing units or new customers prior to or at the time service begins.

(b) *What is the requirement for non-community water systems?* Non-community water systems must continuously post the public notice in conspicuous locations in order to inform new consumers of any continuing violation, variance or exemption, or other situation requiring a public notice for as long as the violation, variance, exemption, or other situation persists.

(7) Special Notice of the Availability of Unregulated Contaminant Monitoring Results.

(a) *When is the special notice to be given?* The owner or operator of a community water system or non-transient, non-community water system required to monitor under R.61-58.5.T must notify persons served by the system of the availability of the results of such sampling no later than 12 months after the monitoring results are known.

(b) *What is the form and manner of the special notice?* The form and manner of the public notice must follow the requirements for a Tier 3 public notice prescribed in paragraphs (4)(c), (d)(i), and (d)(iii) of this section. The notice must also identify a person and provide the telephone number to contact for information on the monitoring results.

(8) Special Notice for Exceedance of the SMCL for Fluoride.

(a) *When is the special notice to be given?* Community water systems that exceed the fluoride secondary maximum contaminant level (SMCL) of 2 mg/l as specified in R.61-58.5.R (determined by the last single sample taken in accordance with R.61-58.5.C, but do not exceed the maximum contaminant level (MCL) of 4 mg/l for fluoride (as specified in R.61-58.5.B), must provide the public notice in paragraph (c) of this section to persons served. Public notice must be provided as soon as practical but no later than twelve (12) months from the day the water system learns of the exceedance. A copy of the notice must also be sent to all new billing units and new customers at the time service begins and to the State public health officer. The public water system must repeat the notice at least annually for as long as the SMCL is exceeded. If the public notice is posted, the notice must remain in place for as long as the SMCL is exceeded, but in no case less than seven (7) days (even if the exceedance is eliminated). On a case-by-case basis, the Department may require an initial notice sooner than twelve (12) months and repeat notices more frequently than annually.

(b) *What is the form and manner of the special notice?* The form and manner of the public notice (including repeat notices) must follow the requirements for a Tier 3 public notice in paragraphs (4)(c) and (d)(i) and (d)(iii) of this section.

(c) What mandatory language must be contained in the special notice? The notice must contain the following language, including the language necessary to fill in the blanks:

“This is an alert about your drinking water and a cosmetic dental problem that might affect children under nine years of age. At low levels, fluoride can help prevent cavities, but children drinking water containing more than 2 milligrams per liter (mg/l) of fluoride may develop cosmetic discoloration of their permanent teeth (dental fluorosis). The drinking water provided by your community water system [name] has a fluoride concentration of [insert value] mg/l.

Dental fluorosis, in its moderate or severe forms, may result in a brown staining and/or pitting of the permanent teeth. This problem occurs only in developing teeth, before they erupt from the gums. Children under nine should be provided with alternative sources of drinking water or water that has been treated to remove the fluoride to avoid the possibility of staining and pitting of their permanent teeth. You may also want to contact your dentist about proper use by young children of fluoride-containing products. Older children and adults may safely drink the water.

Drinking water containing more than 4 mg/L of fluoride (the U.S. Environmental Protection Agency’s drinking water standard) can increase your risk of developing bone disease. Your drinking water does not contain more than 4 mg/l of fluoride, but we’re required to notify you when we discover that the fluoride levels in your drinking water exceed 2 mg/l because of this cosmetic dental problem.

For more information, please call [name of water system contact] of [name of community water system] at [phone number]. Some home water treatment units are also available to remove fluoride from drinking water. To learn more about available home water treatment units, you may call NSF International at 1-877-8-NSF-HELP.”

(9) Special notice for Nitrate Exceedances Above MCL by Non-Community Water Systems (NCWS), Where Granted Permission by the Department under R.61-58.5.B(3).

(a) *When is the special notice to be given?* The owner or operator of a non-community water system granted permission by the Department under R.61-58.5.B(3) to exceed the nitrate MCL must provide notice to persons served according to the requirements for a Tier 1 notice under paragraphs (2)(a) and (b) of this section.

(b) *What is the form and manner of the special notice?* Non-community water systems granted permission by the Department to exceed the nitrate MCL under R.61-58.5.B(3) must provide continuous posting of the fact that nitrate levels exceed 10 mg/l and the potential health effects of exposure, according to the requirements for Tier 1 notice delivery under paragraph (2)(c) of this section and the content requirements under paragraph (5) of this section.

(10) Notice by Department on Behalf of the Public Water System.

(a) *May the Department give the notice on behalf of the public water system?* The Department may give the notice required by this regulation on behalf of the owner and operator of the public water system if the Department complies with the requirements of this regulation.

(b) *What is the responsibility of the public water system when notice is given by the primacy agency?* The owner or operator of the public water system remains responsible for ensuring that the requirements of this regulation are met.

(11) Special notice for repeated failure to conduct monitoring of the source water for Cryptosporidium and for failure to determine bin classification or mean Cryptosporidium level

(a) Special notice for repeated failure to monitor.

The owner or operator of a community or non-community water system that is required to monitor source water under R.61-58.10.K(2) must notify persons served by the water system that monitoring has not been completed as specified no later than 30 days after the system has failed to collect any 3 months of monitoring as specified in R.61-58.10.K(2)(c). The notice must be repeated as specified in R.61-58.6.E(3)(b).

(b) Special notice for failure to determine bin classification or mean Cryptosporidium level.

The owner or operator of a community or non-community water system that is required to determine a bin classification under R.61-58.10.K(11), or to determine mean Cryptosporidium level under R.61-58.10.K(13), must notify persons served by the water system that the determination has not been made as required, no later than 30 days after the system has failed to report the determination as specified in R.61-58.10.K(11)(e) or R.61-58.10.K(13)(a), respectively. The notice must be repeated as specified in R.61-58.6.E(3)(b). The notice is not required if the system is complying with a Department-approved schedule to address the violation.

(c) Form and manner of the special notice.

The form and manner of the public notice must follow the requirements for a Tier 2 public notice prescribed in R.61-58.6.E(3)(c). The public notice must be presented as required in R.61-58.6.E(5)(c).

(d) Mandatory language that must be contained in the special notice.

The notice must contain the following language, including the language necessary to fill in the blanks.

(i) The special notice for repeated failure to conduct monitoring must contain the following language: “We are required to monitor the source of your drinking water for Cryptosporidium. Results of the monitoring are to be used to determine whether water treatment at the (treatment plant name) is sufficient to adequately remove Cryptosporidium from your drinking water. We are required to complete this monitoring and make this determination by (required bin determination date). We (did not monitor or test) or (did not complete all monitoring or testing) on schedule and, therefore, we may not be able to determine by the required date what treatment modifications, if any, must be made to ensure adequate Cryptosporidium removal. Missing this deadline may, in turn, jeopardize our ability to have the required treatment modifications, if any, completed by the deadline required, (date). For more information, please call (name of water system contact) of (name of water system) at (phone number)”.

(ii) The special notice for failure to determine bin classification or mean Cryptosporidium level must contain the following language: “We are required to monitor the source of your drinking water for Cryptosporidium in order to determine by (date) whether water treatment at the (treatment plant name) is sufficient to adequately remove Cryptosporidium from your drinking water. We have not made this determination by the required date. Our failure to do this may jeopardize our ability to have the required treatment modifications, if any, completed

by the required deadline of (date). For more information, please call (name of water system contact) of (name of water system) at (phone number)".

(iii) Each special notice must also include a description of what the system is doing to correct the violation and when the system expects to return to compliance or resolve the situation.

HISTORY: Amended by State Register Volume 17, Issue No. 8, eff August 27, 1993; State Register Volume 17, Issue No. 12, eff December 24, 1993; State Register Volume 18, Issue No. 11, eff November 25, 1994; Amended by State Register Volume 19, Issue No. 7, eff July 28, 1995; State Register Volume 22, Issue No. 6, Part 2, eff June 26, 1998; State Register Volume 24, Issue No. 2, eff February 25, 2000; State Register Volume 25, Issue No. 9, eff September 28, 2001; State Register Volume 26, Issue No. 12, eff December 27, 2002; State Register Volume 30, Issue No. 10, eff October 27, 2006; State Register Volume 32, Issue No. 4, eff April 25, 2008; State Register Volume 38, Issue No. 9, Doc. No. 4469, eff September 26, 2014; SCSR 46-12 Doc. No. 5135, eff December 23, 2022.

APPENDIX A. VIOLATIONS AND OTHER SITUATIONS REQUIRING PUBLIC NOTICE

APPENDIX A TO 61-58.6: VIOLATIONS AND OTHER SITUATIONS REQUIRING PUBLIC NOTICE ¹

CONTAMINANT	MCL/MRDL/TT/VIOLATIONS ²		MONITORING & TESTING PROCEDURE VIOLATIONS	
	TIER OF PUBLIC NOTICE QUIRED	RE- CITATION	TIER OF PUBLIC NOTICE QUIRED	RE-CITATION

I. Violations of the State Primary Drinking Water Regulations (SPDWR): ³

A. Microbiological Contaminants

1.a Total coliform [†]	2	61-58.5.F(1)	3	61-58.5.G(1) — (5)
1.b Total coliform (TT violations resulting from failure to perform assessments or corrective actions, monitoring violations, and reporting violations) [‡]	2	61-58.17.K(2)(a)	3	61-58.17.K(3)(a)
1.c Seasonal system failure to follow Department-approved start-up plan prior to serving water to the public or failure to provide certification to the Department. [‡]	2	61-58.17.K(2)(b)	3	61-58.17.K(4)(a) 61-58.17.K(4)(c)
2. Fecal coliform/E. coli [†]	1	61-58.5.F(2)	4 ¹ , 3	61-58.5.G(5)
3. <i>E. coli</i> (MCL, monitoring, and reporting violations. [‡]	1	61-58.17.K(1)	3	61-58.17.K(3)(b) 61-58.17.K(4)(a) 61-58.17.K(4)(b)
4. c E. coli (TT violations resulting from failure to perform level 2 Assess-	2	61-58.17.K(2)(a)		

ments or corrective action) ‡				
3. Turbidity MCL	2	61-58.10.E, H, & I	3	61-58.10.F
4. Turbidity MCL (average of 2 days samples great than 5 NTU)	5 ^{2,1}	61-58.10.C, E, H & I	3	61-58.10.F
5. Turbidity (for TT violations resulting from a single exceedance of maximum allowable turbidity level)	6 ^{2, 1}	61-58.10.C(i)(b)	3	61-58.10.F
		61-58.10.C.(3)(b) 61-58.10.F(2)(b), 61-58.10.E(1)(b), 61-58.10.E(2)(b), 61-58.10.E(3)(b), 61-58.10.E(4), 61-58.10.H(4)(a)(ii), 61-58.10.H(4)(b), 61-58.10.I(6)(b)		61-58.10(F)(3) 61-58.10.H 61-58.10(I)(7)(a) (i)-(iii) & (b)
6. Surface Water Treatment Rule violations, other than violations resulting from single exceedance of max. allowable turbidity level (TT).	2	61-58.10.B - E		61-58.10
7. Interim Enhanced Surface Water Treatment Rule violations, other than violations resulting from single exceedance of max. turbidity level (TT)	7 ²	61-58.10.B - E	3	61-58.10.H(3), (5)
		61-58.10.I(1)-(7)		61-58.10.I(4) & (5) 61-58.10.I(7)
8. Filter Backwash Recycling Rule violations	2	61-58.10.J(3)	3	61-58.10.J(2) & (4)
9. Long Term 1 Enhanced Surface Water Treatment Rule Violations.	2	61-58.10.I(1)-(7)	3	61-58.10.I(4) & (5)
10. LT2ESWTR violations	2	61-58.10.K(11)-(21)	2 ^{2,3}	61-58.10.I(7) 61-58.10.K(2) - (6) & 61-58.10.K(9) - (10)
11. Ground Water Rule Violations	2	61-58.16.G	3	61-58.16.E(8)
				61-58.16.F(4)

B. Inorganic Chemicals (IOCs)

1. Antimony	2	61-58.5.B(2)	3	61-58.5.C(7), (9)
2. Arsenic	2	61-58.5.B(2)	3	⁹ 61-58.5.C(7)
3. Asbestos (fibers > 10µm)	2	61-58.5.B(2)	3	61-58.5.C(7), (8)
4. Barium	2	61-58.5.B(2)	3	61-58.5.C(7), (9)
5. Beryllium	2	61-58.5.B(2)	3	61-58.5.C(7), (9)

6. Cadmium	2	61-58.5.B(2)	3	61-58.5.C(7), (9)
7. Chromium (total)	2	61-58.5.B(2)	3	61-58.5.C(7), (9)
8. Cyanide	2	61-58.5.B(2)	3	61-58.5.C(7), (9)
9. Fluoride	2	61-58.5.B(2)	3	61-58.5.C(7), (9)
10. Mercury (inorganic)	2	61-58.5.B(2)	3	61-58.5.C(7), (9)
11. Nitrate	1	61-58.5.B(2)	¹⁰ 1,3	61-58.5.C(7), (10) 61-58.5.C(12)
12. Nitrite	1	61-58.5.B(2)	¹⁰ 1,3	61-58.5.C(7), (10) 61-58.5.C(12)
13. Total Nitrate and Nitrite	1	61-58.5.B(2)	3	61-58.5.C(7)
14. Selenium	2	61-58.5.B(2)	3	61-58.5.C(7), (9)
15. Thallium	2	61-58.5.B(2)	3	61-58.5.C(7), (9)

C. Lead and Copper Rule (Action Level for lead is 0.015 mg/L, for copper is 1.3 mg/L)

1. Lead and Copper Rule (TT)	2	61-58.11.B (except 61-58.11.B(3)), 61-58.11.F, 61-58.11.G(1) — (3) and (8), and 61-58.11.O	3	61-58.11.H - L
2. Exceedance of the action Level for Lead	1	61-58.11.B(3)		

D. Synthetic Organic Chemicals (SOCs)

1. 2,4-D	2	61-58.5.D	3	61-58.E(7)
2. 2,4,5-TP (Silvex)	2	61-58.5.D	3	61-58.5.E(7)
3. Alachlor	2	61-58.5.D	3	61-58.5.E(7)
4. Atrazine	2	61-58.5.D	3	61-58.5.E(7)
5. Benzo(a)pyrene (PAHs)	2	61-58.5.D	3	61-58.5.E(7)
6. Carbofuran	2	61-58.5.D	3	61-58.5.E(7)
7. Chlordane	2	61-58.5.D	3	61-58.5.E(7)
8. Dalapon	2	61-58.5.D	3	61-58.5.E(7)
9. Di (2-ethylhexyl) adipate	2	61-58.5.D	3	61-58.5.E(7)
10. Di (2-ethylhexyl) phthalate	2	61-58.5.D	3	61-58.5.E(7)
11. Dibromochloropropane	2	61-58.5.D	3	61-58.5.E(7)
12. Dinoseb	2	61-58.5.D	3	61-58.5.E(7)
13. Dioxin (2,3,7,8-TCDD)	2	61-58.5.D	3	61-58.5.E(7)
14. Diquat	2	61-58.5.D	3	61-58.5.E(7)
15. Endothall	2	61-58.5.D	3	61-58.5.E(7)
16. Endrin	2	61-58.5.D	3	61-58.5.E(7)
17. Ethylene dibromide	2	61-58.5.D	3	61-58.5.E(7)
18. Glyphosate	2	61-58.5.D	3	61-58.5.E(7)
19. Heptachlor	2	61-58.5.D	3	61-58.5.E(7)
20. Heptachlor epoxide	2	61-58.5.D	3	61-58.5.E(7)
21. Hexachlorobenzene	2	61-58.5.D	3	61-58.5.E(7)
22. Hexachlorocyclopentadiene	2	61-58.5.D	3	61-58.5.E(7)

23. Lindane	2	61-58.5.D	3	61-58.5.E(7)
24. Methoxychlor	2	61-58.5.D	3	61-58.5.E(7)
25. Oxamyl (Vyd- ate)	2	61-58.5.D	3	61-58.5.E(7)
26. Pentachlorophe- nol	2	61-58.5.D	3	61-58.5.E(7)
27. Picloram	2	61-58.5.D	3	61-58.5.E(7)
28. Polychlorinated biphenyls (PCBs)	2	61-58.5.D	3	61-58.5.E(7)
29. Simazine	2	61-58.5.D	3	61-58.5.E(7)
30. Toxaphene	2	61-58.5.D	3	61-58.5.E(7)

E. Volatile Organic Chemicals (VOCs)

1. Benzene	2	61-58.5.N	3	61-58.5.O
2. Carbon tetrachlo- ride	2	61-58.5.N	3	61-58.5.O
3. Chlorobenzene (monochloroben- zene)	2	61-58.5.N	3	61-58.5.O
4. o-Dichloroben- zene	2	61-58.5.N	3	61-58.5.O
5. p-Dichloroben- zene	2	61-58.5.N	3	61-58.5.O
6. 1,2-Dichloroe- thane	2	61-58.5.N	3	61-58.5.O
7. 1,1-Dichloroethy- lene	2	61-58.5.N	3	61-58.5.O
8. cis-1,2-Dichloroe- thylene	2	61-58.5.N	3	61-58.5.O
9. trans-1,2-Dichlo- roethylene	2	61-58.5.N	3	61-58.5.O
10. Dichlorometh- ane	2	61-58.5.N	3	61-58.5.O
11. 1,2-Dichloro- propane	2	61-58.5.N	3	61-58.5.O
12. Ethylbenzene	2	61-58.5.N	3	61-58.5.O
13. Styrene	2	61-58.5.N	3	61-58.5.O
14. Tetrachloroe- thylene	2	61-58.5.N	3	61-58.5.O
15. Toluene	2	61-58.5.N	3	61-58.5.O
16. 1,2,4-Trichloro- benzene	2	61-58.5.N	3	61-58.5.O
17. 1,1,1-Trichloro- ethane	2	61-58.5.N	3	61-58.5.O
18. 1,1,2-Trichloro- ethane	2	61-58.5.N	3	61-58.5.O
19. Trichloroethy- lene	2	61-58.5.N	3	61-58.5.O
20. Vinyl chloride	2	61-58.5.N	3	61-58.5.O
21. Xylenes (total)	2	61-58.5.N	3	61-58.5.O

F. Radioactive Contaminants

1. Beta/photon emitters	2	61-58.5.H(4)	3	61-58.5.K(1), 61-58.5.I(3)
2. Alpha emitters	2	61-58.5.H(3)	3	61-58.5.K(1), 61-58.5.I(2)
3. Combined radi- um (226 & 228)	2	61-58.5.H(2)	3	61-58.5.K(1), 61-58.5.I(2)

4. Uranium	¹¹ 2	61-58.5.H(5)	¹² 3	61-58.5.K(1), 61-58.5.I(2)
------------	-----------------	--------------	-----------------	-------------------------------

G. Disinfection Byproducts (DBPs), Byproduct Precursors, Disinfectant Residuals. Where disinfection is used in the treatment of drinking water, disinfectants combine with organic and inorganic matter present in water to form chemicals called disinfection byproducts (DBPs). EPA sets standards for controlling the levels of disinfectants and DBPs in drinking water, including trihalomethanes (THMs) and haloacetic acids (HAAs). ¹³

1. Total trihalo- methanes (TTHMs)	2	¹⁴ 61-58.5.L, 61-58.5.P	3	¹⁴ 61-58.5.M 61-58.13.C(1), (2) 61-58.14, 61-58.15
2. Haloacetic Acids (HAA5)	2	61-58.5.P	3	61-58.13.C(1), (2) 61-58.14, 61-58.15
3. Bromate	2	61-58.5.P	3	61-58.13.C(1), (2)
4. Chlorite	2	61-58.5.P	3	61-58.13.C(1), (2)
5. Chlorine (MRDL)	2	61-58.5.Q	3	61-58.13.C(1), (3)
6. Chloramine (MRDL)	2	61-58.5.Q	3	61-58.13.C(1), (3)
7. Chlorine dioxide (MRDL) where any 2 consecutive daily samples at entrance to distribution sys- tem only are above MRDL	2	61-58.5.Q,	2 ¹⁵ , 3	61-58.13.C(1), (3),
8. Chlorine dioxide (MRDL), where sample(s) in distri- bution system the next day are also above MRDL	¹⁶ 1	61-58.13.D 61-58.5.Q,	1	61-58.13.C(3)(b) 61-58.13.C(1), (3),
9. Control of DBP precursors—TOC (TT)	2	61-58.13.D(3) 61-58.13.F(1), (2)	3	61-58.13.D(3)(b) 61-58.13.C(1), (4)
10. Bench marking and disinfection profiling.	N/A	N/A	3	61-58.10.G(3) 61-58.10.H(3) 61-58.10.I(4) & (5) 61-58.13.C(6)
11. Development of monitoring plan	N/A	N/A	3	

H. Other Treatment Techniques

1. Acrylamide (TT)	2	61-58.5.AA	N/A	N/A
2. Epichlorohydrin (TT)	2	61-58.5.AA	N/A	N/A

II. Unregulated Contaminant Monitoring: ¹⁷

A. Unregulated contaminants	N/A	N/A	3	61-58.5.T
B. Nickel	N/A	N/A	3	61-58.5.C(9), (17)

III. Public Notification for Variances and Exemptions:

A. Operation under a variance or exemption	3	1861–58.9	N/A	N/A
B. Violation of conditions of a variance or exemption	2	1961–58.9	N/A	N/A

IV. Other Situations Requiring Public Notification:

A. Fluoride secondary maximum contaminant level (SMCL) exceedance	3	61–58.5.R	N/A	N/A
B. Exceedance of nitrate MCL for non-community systems, as allowed by Department	1	61–58.5.B(3)	N/A	N/A
C. Availability of unregulated contaminant monitoring data	3	61–58.5.T	N/A	N/A
D. Waterborne disease outbreak	1	61–58.B(156) 61–58.10.C(3)(b)(ii)	N/A	N/A
E. Other waterborne emergency ²⁰	1	N/A	N/A	N/A
F. Source water sample positive for Ground Water Rule fecal indicators: E. coli, enterococci, or coliphage	1	61–58.16.E(7)	N/A	N/A
G. Other situations as determined by the Department	²¹ 1, 2, 3	N/A	N/A	N/A

Appendix A to R.61–58.6 - Endnotes

† Until March 31, 2016

‡ Beginning April 1, 2016

¹ Violations and other situations not listed in this table (e.g., failure to prepare Consumer Confidence Reports), do not require notice, unless otherwise determined by the Department. The Department may, at its option, also require a more stringent public notice tier (e.g., Tier 1 instead of Tier 2 or Tier 2 instead of Tier 3) for specific violations and situations listed in this Appendix, as authorized under R.61–58.6.E(2)(a) and (3)(a).

² MCL—Maximum contaminant level, MRDL—Maximum residual disinfectant level, TT—Treatment technique

³ The term Violations of State Primary Drinking Water Regulations (SPDWR) is used here to include violations of MCL, MRDL, treatment technique, monitoring, and testing procedure requirements.

⁴ Failure to test for fecal coliform or E. coli is a Tier 1 violation if testing is not done after any repeat sample tests positive for coliform. All other total coliform monitoring and testing procedure violations are Tier 3.

⁵ Systems that violate the turbidity MCL of 5 NTU based on an average of measurements over two consecutive days must consult with the Department within 24 hours after learning of the violation. Based on this consultation, the Department may subsequently decide to elevate the violation to Tier 1. If a system is unable to make contact with the Department in the 24-hour period, the violation is automatically elevated to Tier 1.

⁶ Systems with treatment technique violations involving a single exceedance of a maximum turbidity limit under the Surface Water Treatment Rule (SWTR) Interim Enhanced Surface Water Treatment Rule (IESWTR), or the Long Term 1 Enhanced Surface Water Treatment Rule (LT1ESWTR) are required to consult with the Department within 24 hours after learning of the violation. Based on this consultation, the Department may subsequently decide to elevate the violation to Tier 1. If a system is

unable to make contact with the Department in the 24-hour period, the violation is automatically elevated to Tier 1.

⁷ Most of the requirements of the Interim Enhanced Surface Water Treatment Rule, R.61-58.10.B - C become effective January 1, 2002 for surface water systems and ground water systems under the direct influence of surface water serving at least 10,000 persons. However, R.61-58.10.H(3) has some requirements that become effective as early as April 16, 1999. The Surface Water Treatment Rule remains in effect for systems serving at least 10,000 persons even after 2002; the Interim Enhanced Surface Water Treatment Rule adds additional requirements and does not in many cases supersede the SWTR.

⁸ The arsenic MCL citations are effective January 23, 2006. Until then the citations are R.61-58.5(B)(2).

⁹ The arsenic Tier 3 violations MCL citations are effective January 23, 2006. Until then, the citations are R.61-58.C(7).

¹⁰ Failure to take a confirmation sample within 24 hours for nitrate or nitrite after an initial sample exceeds the MCL is a Tier 1 violation. Other monitoring violations for nitrate are Tier 3.

¹¹ The uranium MCL, Tier 2 violation citations are effective December 8, 2003 for all community water systems.

¹² The uranium Tier 3 violation citations are effective December 8, 2000 for all community water systems.

¹³ Community and non-transient non-community surface water systems and ground water systems under the direct influence of surface water serving 10,000 must comply with new DBP MCLs, disinfectant MRDLs, and related monitoring requirements beginning January 1, 2002. All other community and non-transient non-community systems must meet the MCLs and MRDLs beginning January 1, 2004. Transient non-community surface water systems and ground water systems under the direct influence of surface water serving 10,000 or more persons and using chlorine dioxide as a disinfectant or oxidant must comply with the chlorine dioxide MRDL beginning January 1, 2002. Transient non-community surface water systems and ground water systems under the direct influence of surface water serving fewer than 10,000 persons and using only ground water not under the direct influence of surface water and using chlorine dioxide as a disinfectant or oxidant must comply with the chlorine dioxide MRDL beginning January 1, 2004.

¹⁴ R.61-58.5.L, and R.61-58.13.C(1) - (2) apply until R.61-58.14 and R.61-58.15 take effect under the schedule in R.61-58.14.

¹⁵ Failure to monitor for chlorine dioxide at the entrance to the distribution system the day after exceeding the MRDL at the entrance to the distribution system is a Tier 2 violation.

¹⁶ If any daily sample taken at the entrance to the distribution system exceeds the MRDL for chlorine dioxide and one or more samples taken in the distribution system the next day exceed the MRDL, Tier 1 notification is required. Failure to take the required samples in the distribution system after the MRDL is exceeded at the entry point also triggers Tier 1 notification.

¹⁷ Some water systems must monitor for certain unregulated contaminants listed in R.61-58.5.T

¹⁸ This citation refers to the requirements of R.61-58.9 that "a schedule prescribed ...for a public water system granted a variance [or exemption] shall require compliance by the system ..."

¹⁹ In addition to R.61-58.9 specifies the items and schedule milestones that must be included in a variance for small systems.

²⁰ Other waterborne emergencies require a Tier 1 public notice under R.61-58.6.E(2)(a) for situations that do not meet the definition of a waterborne disease outbreak given in R.61-58.B(174) but that still have the potential to have serious adverse effects on health as a result of short-term exposure. These could include outbreaks not related to treatment deficiencies, as well as situations that have the potential to cause outbreaks, such as failures or significant interruption in water treatment processes, natural disasters that disrupt the water supply or distribution system, chemical spills, or unexpected loading of possible pathogens into the source water.

²¹ The Department may place other situations in any tier they believe appropriate, based on threat to public health.

²² Failure to collect three or more samples for Cryptosporidium analysis is a Tier 2 violation requiring special notice as specified in R.61-58.6.E(11). All other monitoring and testing procedure violations are Tier 3.

HISTORY: Amended by State Register Volume 26, Issue No. 12, eff December 27, 2002; State Register Volume 27, Issue No. 9, eff September 26, 2003; State Register Volume 28, Issue No. 1, eff January 23, 2004; State Register Volume 30, Issue No. 10, eff October 27, 2006; State Register Volume 32, Issue No. 4, eff April 25, 2008; State Register Volume 38, Issue No. 9, Doc. No. 4469, eff September 26, 2014; SCSR 46-12 Doc. No. 5135, eff December 23, 2022.

APPENDIX B. STANDARD HEALTH EFFECTS LANGUAGE FOR PUBLIC NOTIFICATION

APPENDIX B TO R.61–58.6: STANDARD HEALTH EFFECTS LANGUAGE FOR PUBLIC NOTIFICATION

Contaminant	MCLG ¹ mg/L	MCL ² mg/L	Standard health effects language for public notification
State Primary Drinking Water Regulations (SPDWR):			
A. Microbiological Contaminants:			
1a. Total coliform †	Zero	See footnote ³	Coliforms are bacteria that are naturally present in the environment and are used as an indicator that other, potentially harmful, bacteria may be present. Coliforms were found in more samples than allowed and this was a warning of potential problems.
1b. Fecal coliform/E. coli ‡	Zero	Zero	Fecal coliforms and E. coli are bacteria whose presence indicates that the water may be contaminated with human or animal wastes. Microbes in these wastes can cause short-term effects, such as diarrhea, cramps, nausea, headaches, or other symptoms. They may pose a special health risk for infants, young children, some of the elderly, and people with severely compromised immune systems.
1c. Fecal Indicators (Ground Water Rule)			
i. E. coli	Zero	TT	Fecal indicators are microbes whose presence indicates that the water may be contaminated with human or animal wastes.
ii. enterococci	None	TT	Microbes in these wastes can cause short-term health effects, such
iii. coliphage	None	TT	as diarrhea, cramps, nausea, headaches, or other symptoms. They may pose a special health risk for infants, young children, some of the elderly, and people with severely compromised immune systems.
1d. Ground Water Rule TT violations	None	TT	Inadequately treated or inadequately protected water may contain disease-causing organisms. These organisms can cause symptoms such as diarrhea, nausea, cramps, and associated headaches.
1e. Revised Total Coliform Rule (R.61–58.17) Coliform Assessment and/or Corrective Action Violations ‡	N/A	TT	Coliforms are bacteria that are naturally present in the environment and are used as an indicator that other, potentially harmful, waterborne pathogens may be present or that a potential

Contaminant	MCLG ¹ mg/L	MCL ² mg/L	Standard health effects language for public notification
			<p>pathway exists through which contamination may enter the drinking water distribution system. We found coliforms indicating the need to look for potential problems in water treatment or distribution. When this occurs, we are required to conduct assessments to identify problems and to correct any problems that are found. [THE SYSTEM MUST USE THE FOLLOWING APPLICABLE SENTENCES.]</p> <p>We failed to conduct the required assessment.</p> <p>We failed to correct all identified sanitary defects that were found during the assessment(s).</p>
<p>If. Revised Total Coliform Rule (R.61-58.17) E. coli Assessment and/or Corrective Action Violations ‡</p>	N/A		<p>E. coli are bacteria whose presence indicates that the water may be contaminated with human or animal wastes. Human pathogens in these waters can cause short-term effects, such as diarrhea, cramps, nausea, headaches, or other symptoms. They may pose a greater health risk for infants, young children, the elderly, and people with severely compromised immune systems. We violated the standard for E. coli, indicating the need to look for potential problems in water treatment or distribution. When this occurs, we are required to conduct a detailed assessment to identify problems and to correct any problems that are found. [THE SYSTEM MUST USE THE FOLLOWING APPLICABLE SENTENCES.]</p> <p>We failed to conduct the required assessment.</p> <p>We failed to correct all identified sanitary defects that were found during the assessment that we conducted.</p>
1g. E. coli ‡	Zero	<p>In compliance unless one of the following conditions occurs: (1) The system has an E. coli-positive repeat sample follow-</p>	<p>E. coli are bacteria who presence indicates that the water may be contaminated with human or animal wastes. Human pathogens in these wastes can cause short-term effects, such as diarrhea, cramps, nausea, headaches, or other symptoms. They may pose a greater health risk for infants,</p>

Contaminant	MCLG ¹ mg/L	MCL ² mg/L	Standard health effects language for public notification
		<p>ing a total coliform-positive routine sample.</p> <p>(2) The system has a total coliform-positive repeat sample following an E. coli-positive routine sample.</p> <p>(3) The system fails to take all required repeat samples following an E. coli-positive routine sample.</p> <p>(4) The system fails to test for E. coli when any repeat sample tests positive for total coliform.</p>	<p>young children, the elderly, and people with severely compromised immune systems.</p>
1h. Revised Total Coliform Rule (R.61–58.17) Seasonal System TT Violations ‡	N/A	TT	<p>When this violation includes the failure to monitor for total coliforms or E. coli prior to serving water to the public, the mandatory language found at R.61–58.6.E(5)(d)(ii) must be used. When this violation includes failure to complete other actions, the appropriate elements found in R.61–58.6.E(5)(a) to describe the violation must be used.</p>
2a. Turbidity (MCL) ⁴	None	1 NTU ^{5/5} NTU	<p>Turbidity has no health effects. However, turbidity can interfere with disinfection and provide a medium for microbial growth. Turbidity may indicate presence of disease-causing organisms. These organisms include bacteria, viruses, and parasites that can cause symptoms such as nausea, cramps, diarrhea and associated headaches.</p>
2b. Turbidity (SWTR TT) ⁶	None	TT ⁷	<p>Turbidity has no health effects. However, turbidity can interfere with disinfection and provide a medium for microbial growth. Turbidity may indicate the presence of disease-causing organisms. These organisms include bacteria, viruses, and parasites that can cause symptoms such as</p>

Contaminant	MCLG ¹ mg/L	MCL ² mg/L	Standard health effects language for public notification
			nausea, cramps, diarrhea and associated headaches.
2c. Turbidity (IESWTR TT) ⁸	None	TT	Turbidity has no health effects. However, turbidity can interfere with disinfection and provide a medium for microbial growth. Turbidity may indicate the presence of disease-causing organisms. These organisms include bacteria, viruses, and parasites that can cause symptoms such as nausea, cramps, diarrhea and associated headaches.
B. Surface Water Treatment Rule (SWTR), Interim Enhanced Surface Water Treatment Rule (IESWTR), Long Term 1 Enhanced Surface Water Treatment Rule (LT1ESWTR) and Filter Backwash Recycling Rule (FBRR) violations:			
3. <i>Giardia lamblia</i>	Zero	TT ¹⁰	Inadequately treated water may contain disease-causing organisms. These organisms include bacteria, viruses, and parasites which can cause symptoms such as nausea, cramps, diarrhea, and associated headaches.
4. Viruses (SWTR/IESWTR/LT1ESWTR).			
5. Heterotrophic plate count (HPC) bacteria ⁹ (SWTR/IESWTR/LT1ESWTR).			
6. <i>Legionella</i> (SWTR/IESWTR/LT1ESWTR).			
7. <i>Cryptosporidium</i> (SWTR/IESWTR/LT1ESWTR).			
C. Inorganic Chemicals (IOCs):			
8. Antimony	0.006	0.006	Some people who drink water containing antimony well in excess of the MCL over many years could experience increases in blood cholesterol and decreases in blood sugar.
9. Arsenic ¹¹	Zero	0.010	Some people who drink water containing arsenic in excess of the MCL over many years could experience skin damage or problems with their circulatory system, and may have an increased risk of getting cancer.
10. Asbestos (10 µm)	7 MFL ¹²	7 MFL	Some people who drink water containing asbestos in excess of the MCL over many years may have an increased risk of developing benign intestinal polyps.
11. Barium	2	2	Some people who drink water containing barium in excess of the MCL over many years could experience an increase in their blood pressure.
12. Beryllium	0.004	0.004	Some people who drink water containing beryllium well in ex-

Contaminant	MCLG ¹ mg/L	MCL ² mg/L	Standard health effects language for public notification
13. Cadmium	0.005	0.005	Some people who drink water containing cadmium in excess of the MCL over many years could experience kidney damage.
14. Chromium (total)	0.1	0.1	Some people who use water containing chromium well in excess of the MCL over many years could experience allergic dermatitis.
15. Cyanide	0.2	0.2	Some people who drink water containing cyanide well in excess of the MCL over many years could experience nerve damage or problems with their thyroid.
16. Fluoride	4.0	4.0	Some people who drink water containing fluoride in excess of the MCL over many years could get bone disease, including pain and tenderness of the bones. Fluoride in drinking water at half the MCL or more may cause mottling of children's teeth, usually in children less than nine years old. Mottling, also known as dental fluorosis, may include brown staining and/or pitting of the teeth, and occurs only in developing teeth before they erupt from the gums.
17. Mercury (inorganic)	0.002	0.002	Some people who drink water containing inorganic mercury well in excess of the MCL over many years could experience kidney damage.
18. Nitrate	10	10	Infants below the age of six months who drink water containing nitrate in excess of the MCL could become seriously ill and, if untreated, may die. Symptoms include shortness of breath and blue baby syndrome.
19. Nitrite	1	1	Infants below the age of six months who drink water containing nitrite in excess of the MCL could become seriously ill and, if untreated, may die. Symptoms include shortness of breath and blue baby syndrome.
20. Total Nitrate and Nitrite	10	10	Infants below the age of six months who drink water containing nitrate and nitrite in excess of the MCL could become seriously ill and, if untreated, may die. Symptoms include shortness of breath and blue baby syndrome.

Contaminant	MCLG ¹ mg/L	MCL ² mg/L	Standard health effects language for public notification
21. Selenium	0.05	0.05	Selenium is an essential nutrient. However, some people who drink water containing selenium in excess of the MCL over many years could experience hair or fingernail losses, numbness in fingers or toes, or problems with their circulation.
22. Thallium	0.0005	0.002	Some people who drink water containing thallium in excess of MCL over many years could experience hair loss, changes in their blood, or problems with their kidneys, intestines, or liver.
D. Lead and Copper Rule:			
23. Lead	Zero	TT ¹³	Exposure to lead in drinking water can cause serious health effects in all age groups. Infants and children can have decreases in IQ and attention span. Lead exposure can lead to new learning and behavior problems. The children of women who are exposed to lead before or during pregnancy can have increased risk of these adverse health effects. Adults can have increased risks of heart disease, high blood pressure, kidney or nervous system problems.
24. Copper	1.3	TT ¹⁴	Copper is an essential nutrient, but some people who drink water containing copper in excess of the action level over a relatively short amount of time could experience gastrointestinal distress. Some people who drink water containing copper in excess of the action level over many years could suffer liver or kidney damage. People with Wilson's Disease should consult their personal doctor.
E. Synthetic Organic Chemicals (SOCs):			
25. 2,4-D	0.07	0.07	Some people who drink water containing the weed killer 2,4-D well in excess of the MCL over many years could experience problems with kidneys, liver, or adrenal glands.
26. 2,4,5-TP (Silvex)	0.05	0.05	Some people who drink water containing silvex in excess of the MCL over many years could experience liver problems.
27. Alachlor	Zero	0.002	Some people who drink water containing alachlor in excess of the MCL over many years could have problems with their eyes, liver, kidneys, or spleen, or ex-

Contaminant	MCLG ¹ mg/L	MCL ² mg/L	Standard health effects language for public notification
			perience anemia, and may have an increased risk of getting cancer.
28. Atrazine	0.003	0.003	Some people who drink water containing atrazine well in excess of the MCL over many years could experience problems with their cardiovascular system or reproductive difficulties.
29. Benzo(a)pyrene (PAHs)	Zero	0.0002	Some people who drink water containing benzo(a)pyrene in excess of the MCL over many years may experience reproductive difficulties and may have an increased risk of getting cancer.
30. Carbofuran	0.04	0.04	Some people who drink water containing carbofuran in excess of the MCL over many years could experience problems with their blood, or nervous or reproductive systems.
31. Chlordane	Zero	0.002	Some people who drink water containing chlordane in excess of the MCL over many years could experience problems with their liver or nervous system, and may have an increased risk of getting cancer.
32. Dalapon	0.2	0.2	Some people who drink water containing dalapon well in excess of the MCL over many years could experience minor kidney changes.
33. Di (2-ethylhexyl) adipate	0.4	0.4	Some people who drink water containing di(2-ethylhexyl) adipate well in excess of the MCL over many years could experience toxic effects such as weight loss, liver enlargement or possible reproductive difficulties.
33. Di (2-ethylhexyl) phthalate	Zero	0.006	Some people who drink water containing di(2-ethylhexyl) phthalate well in excess of the MCL over many years may have problems with their liver, or experience reproductive difficulties, and may have an increased risk of getting cancer.
35. Dibromochloropropane (DBCP)	Zero	0.0002	Some people who drink water containing DBCP in excess of the MCL over many years could experience reproductive difficulties and may have an increased risk of getting cancer.
36. Dinoseb	0.007	0.007	Some people who drink water containing dinoseb well in excess of the MCL over many years

Contaminant	MCLG ¹ mg/L	MCL ² mg/L	Standard health effects language for public notification
37. Dioxin (2,3,7,8-TCDD)	Zero	3×10^{-8}	could experience reproductive difficulties. Some people who drink water containing dioxin in excess of the MCL over many years could experience reproductive difficulties and may have an increased risk of getting cancer.
38. Diquat	0.02	0.02	Some people who drink water containing diquat in excess of the MCL over many years could get cataracts.
39. Endothall	0.1	0.1	Some people who drink water containing endothall in excess of the MCL over many years could experience problems with their stomach or intestines.
40. Endrin	0.002	0.002	Some people who drink water containing endrin in excess of the MCL over many years could experience liver problems.
41. Ethylene dibromide	Zero	0.00005	Some people who drink water containing ethylene dibromide in excess of the MCL over many years could experience problems with their liver, stomach, reproductive system, or kidneys, and may have an increased risk of getting cancer.
42. Glyphosate	0.7	0.7	Some people who drink water containing glyphosate in excess of the MCL over many years could experience problems with their kidneys or reproductive difficulties.
43. Heptachlor	Zero	0.0004	Some people who drink water containing heptachlor in excess of the MCL over many years could experience liver damage and may have an increased risk of getting cancer.
44. Heptachlor epoxide	Zero	0.0002	Some people who drink water containing heptachlor epoxide in excess of the MCL over many years could experience liver damage, and may have an increased risk of getting cancer.
45. Hexachlorobenzene	Zero	0.001	Some people who drink water containing hexachlorobenzene in excess of the MCL over many years could experience problems with their liver or kidneys, or adverse reproductive effects, and may have an increased risk of getting cancer.
46. Hexachlorocyclo pentadiene	0.05	0.05	Some people who drink water containing Hexachlorocyclo-pentadiene well in excess of the MCL over many years could ex-

Contaminant	MCLG ¹ mg/L	MCL ² mg/L	Standard health effects language for public notification
			perience problems with their kidneys or stomach.
47. Lindane	0.0002	0.0002	Some people who drink water containing lindane in excess of the MCL over many years could experience problems with their kidneys or liver.
48. Methoxychlor	0.04	0.04	Some people who drink water containing methoxychlor in excess of the MCL over many years could experience reproductive difficulties.
49. Oxamyl (Vydate)	0.2	0.2	Some people who drink water containing oxamyl in excess of the MCL over many years could experience slight nervous system effects.
50. Pentachlorophenol	Zero	0.001	Some people who drink water containing pentachlorophenol in excess of the MCL over many years could experience problems with their liver or kidneys, and may have an increased risk of getting cancer.
51. Picloram	0.5	0.5	Some people who drink water containing picloram in excess of the MCL over many years could experience problems with their liver.
52. Polychlorinated biphenyls (PCBs)	Zero	0.0005	Some people who drink water containing PCBs in excess of the MCL over many years could experience changes in their skin, problems with their thymus gland, immune deficiencies, or reproductive or nervous system difficulties, and may have an increased risk of getting cancer.
53. Simazine	0.004	0.004	Some people who drink water containing simazine in excess of the MCL over many years could experience problems with their blood.
54. Toxaphene	Zero	0.003	Some people who drink water containing toxaphene in excess of the MCL over many years could have problems with their kidneys, liver, or thyroid, and may have an increased risk of getting cancer.
F. Volatile Organic Chemicals (VOCs):			
55. Benzene	Zero	0.005	Some people who drink water containing benzene in excess of the MCL over many years could experience anemia or a decrease in blood platelets, and may have an increased risk of getting cancer.

Contaminant	MCLG ¹ mg/L	MCL ² mg/L	Standard health effects language for public notification
56. Carbon tetrachloride	Zero	0.005	Some people who drink water containing carbon tetrachloride in excess of the MCL over many years could experience problems with their liver and may have an increased risk of getting cancer.
57. Chlorobenzene (monochlorobenzene)	0.1	0.1	Some people who drink water containing chlorobenzene in excess of the MCL over many years could experience problems with their liver or kidneys.
58. o-Dichlorobenzene	0.6	0.6	Some people who drink water containing o-dichlorobenzene well in excess of the MCL over many years could experience problems with their liver, kidneys, or circulatory systems.
59. p-Dichlorobenzene	0.075	0.075	Some people who drink water containing p-dichlorobenzene in excess of the MCL over many years could experience anemia, damage to their liver, kidneys, or spleen, or changes in their blood.
60. 1,2-Dichloroethane	Zero	0.005	Some people who drink water containing 1,2-dichloroethane in excess of the MCL over many years may have an increased risk of getting cancer.
61. 1,1-Dichloroethylene	0.007	0.007	Some people who drink water containing 1,1-dichloroethylene in excess of the MCL over many years could experience problems with their liver.
62. cis-1,2-Dichloroethylene	0.07	0.07	Some people who drink water containing cis-1,2-dichloroethylene in excess of the MCL over many years could experience problems with their liver.
63. trans-1,2-Dichloroethylene	0.1	0.1	Some people who drink water containing trans-1,2-dichloroethylene well in excess of the MCL over many years could experience problems with their liver.
64. Dichloromethane	Zero	0.005	Some people who drink water containing dichloromethane in excess of the MCL over many years could have liver problems and may have an increased risk of getting cancer.
65. 1,2-Dichloropropane	Zero	0.005	Some people who drink water containing 1,2-dichloropropane in excess of the MCL over many years may have an increased risk of getting cancer.
66. Ethylbenzene	0.7	0.7	Some people who drink water containing ethylbenzene well in excess of the MCL over many

Contaminant	MCLG ¹ mg/L	MCL ² mg/L	Standard health effects language for public notification
			years could experience problems with their liver or kidneys.
67. Styrene	0.1	0.1	Some people who drink water containing styrene well in excess of the MCL over many years could have problems with their liver, kidneys, or circulatory system.
68. Tetrachloroethylene	Zero	0.005	Some people who drink water containing tetrachloroethylene in excess of the MCL over many years could have problems with their liver, and may have an increased risk of getting cancer.
69. Toluene	1	1	Some people who drink water containing toluene well in excess of the MCL over many years could have problems with their nervous system, kidneys, or liver.
70. 1,2,4-Trichlorobenzene	0.07	0.07	Some people who drink water containing 1,2,4-trichlorobenzene well in excess of the MCL over many years could experience changes in their adrenal glands.
71. 1,1,1-Trichloroethane	0.2	0.2	Some people who drink water containing 1,1,1-trichloroethane in excess of the MCL over many years could experience problems with their liver, nervous system, or circulatory system.
72. 1,1,2-Trichloroethane	0.003	0.005	Some people who drink water containing 1,1,2-trichloroethane well in excess of the MCL over many years could have problems with their liver, kidneys, or immune systems.
73. Trichloroethylene	Zero	0.005	Some people who drink water containing trichloroethylene in excess of the MCL over many years could experience problems with their liver and may have an increased risk of getting cancer.
74. Vinyl chloride	Zero	0.002	Some people who drink water containing vinyl chloride in excess of the MCL over many years may have an increased risk of getting cancer.
75. Xylenes (total)	10	10	Some people who drink water containing xylenes in excess of the MCL over many years could experience damage to their nervous system.
G. Radioactive Contaminants:			
76. Beta/photon emitters	Zero	4 mrem/yr ¹⁵	Certain minerals are radioactive and may emit forms of radiation known as photons and beta radiation. Some people who drink

Contaminant	MCLG ¹ mg/L	MCL ² mg/L	Standard health effects language for public notification
			water containing beta and photon emitters in excess of the MCL over many years may have an increased risk of getting cancer.
77. Alpha emitters	Zero	15 pCi/L ¹⁶	Certain minerals are radioactive and may emit a form of radiation known as alpha radiation. Some people who drink water containing alpha emitters in excess of the MCL over many years may have an increased risk of getting cancer.
78. Combined radium (226 & 228)	Zero	5 pCi/L	Some people who drink water containing radium 226 or 228 in excess of the MCL over many years may have an increased risk of getting cancer.
79. Uranium ¹⁷	Zero	30µg/L	Some people who drink water containing uranium in excess of the MCL over many years may have an increased risk of getting cancer and kidney toxicity.
H. Disinfection Byproducts (DBPs), Byproduct Precursors, and Disinfectant Residuals: Where disinfection is used in the treatment of drinking water, disinfectants combine with organic and inorganic matter present in water to form chemicals called disinfection byproducts (DBPs). EPA sets standards for controlling the levels of disinfectants and DBPs in drinking water, including trihalomethanes (THMs) and haloacetic acids (HAAs): ¹⁸			
80. Total trihalomethanes (TTHMs)	N/A	0.08017 ^{19, 20}	Some people who drink water containing trihalomethanes in excess of the MCL over many years may experience problems with their liver, kidneys, or central nervous system, and may have an increased risk of getting cancer.
81. Haloacetic Acids (HAA)	N/A	0.060 ²¹	Some people who drink water containing haloacetic acids in excess of the MCL over many years may have an increased risk of getting cancer.
82. Bromate	Zero	0.010	Some people who drink water containing bromate in excess of the MCL over many years may have an increased risk of getting cancer.
83. Chlorite	0.08	1.0	Some infants and young children who drink water containing chlorite in excess of the MCL could experience nervous system effects. Similar effects may occur in fetuses of pregnant women who drink water containing chlorite in excess of the MCL. Some people may experience anemia.
84. Chlorine	4 (MRDLG) ²²	4.0 (MRDL) ²³	Some people who use water containing chlorine well in excess of the MRDL could experience irri-

Contaminant	MCLG ¹ mg/L	MCL ² mg/L	Standard health effects language for public notification
			tating effects to their eyes and nose. Some people who drink water containing chlorine well in excess of the MRDL could experience stomach discomfort.
85. Chloramines	4 (MRDLG)	4.0 (MRDL)	Some people who use water containing chloramines well in excess of the MRDL could experience irritating effects to their eyes and nose. Some people who drink water containing chloramines well in excess of the MRDL could experience stomach discomfort or anemia.
86a. Chlorine dioxide, where any 2 consecutive daily samples taken at the entrance to the distribution system are above the MRDL.	0.8 (MRDLG)	0.8 (MRDL)	Some infants and young children who drink water containing chlorine dioxide in excess of the MRDL could experience nervous system effects. Similar effects may occur in fetuses of pregnant women who drink water containing chlorine dioxide in excess of the MRDL. Some people may experience anemia. <i>Add for public notification only:</i> The chlorine dioxide violations reported today are the result of exceedances at the treatment facility only not within the distribution system which delivers water to consumers. Continued compliance with chlorine dioxide levels within the distribution system minimizes the potential risk of these violations to consumers.
86b. Chlorine dioxide, where one or more water distribution systems are above the MRDL	0.8 (MRDLG)	0.8 (MRDL)	Some infants and young children who drink water containing chlorine dioxide in excess of the MRDL could experience nervous effects. Similar effects may occur in fetuses of pregnant women who drink water containing chlorine dioxide in excess of the MRDL. Some people may experience anemia. <i>Add for public notification only:</i> The chlorine dioxide violations reported today include exceedances of the EPA standard within the distribution system which delivers water to consumers. Violations of the chlorine dioxide standard within the distribution system may harm human health based on short-term exposures. Certain groups, including fetuses, infants, and young children, may be especially susceptible to nervous system effects from ex-

Contaminant	MCLG ¹ mg/L	MCL ² mg/L	Standard health effects language for public notification
87. Control of DBP precursors (DBP)	None	TT	cessive chlorine dioxide exposure. Total organic carbon (TOC) has no health effects. However, total organic carbon provides a medium for the formation of disinfection by-products. These byproducts include trihalomethanes (THMs) and haloacetic acids (HAAs). Drinking water containing these by-products in excess of the MCL may lead to adverse health effects, liver or kidney problems, or nervous system effects, and may lead to an increased risk of getting cancer.
I. Other Treatment Techniques:			
88. Acrylamide	Zero	TT	Some people who drink water containing high levels of acrylamide over a long period of time could have problems with their nervous system or blood, and may have an increased risk of getting cancer.
89. Epichlorohydrin	Zero	TT	Some people who drink water containing high levels of epichlorohydrin over a long period of time could experience stomach problems, and may have an increased risk of getting cancer.

Appendix B to R.61–58.6 - endnotes

[†] Until March 31, 2016

[‡] Beginning April 1, 2016

¹ MCLG - Maximum contaminant level goal

² MCL - Maximum contaminant level

³ For water systems analyzing at least 40 samples per month, no more than 5.0 percent of the monthly samples may be positive for total coliforms. For systems analyzing fewer than 40 samples per month, no more than one sample per month may be positive for total coliforms.

⁴ There are various regulations that set turbidity standards for different types of systems, including the 1989 Surface Water Treatment Rule, the 1998 Interim Enhanced Surface Water Treatment Rule, and the 2002 Long Term 1 Enhanced Surface Water Treatment Rule. The MCL for the monthly turbidity average is 1 NTU; the MCL for the 2-day average is 5 NTU for systems that are required to filter but have not yet installed filtration.

⁵ NTU - Nephelometric turbidity unit

⁶ There are various regulations that set turbidity standards for different types of systems, including the 1989 Surface Water Treatment Rule (SWTR), the 1998 Interim Enhanced Surface Water Treatment Rule (IESWTR), and the 2001 Long Term 1 Enhanced Surface Water Treatment Rule. Systems subject to the Surface Water Treatment Rule (both filtered and unfiltered) may not exceed 5 NTU. In addition, in filtered systems, 95 percent of samples each month must not exceed 0.5 NTU in systems using conventional or direct filtration and must not exceed 1 NTU in systems using slow sand or diatomaceous earth filtration or other filtration technologies approved by the Department.

⁷ TT - Treatment technique

⁸ There are various regulations that set turbidity standards for different types of systems, including the 1989 Surface Water Treatment Rule (SWTR), the 1998 Interim Enhanced Surface Water Treatment Rule (IESWTR), and the 2002 Long Term 1 Enhanced Surface Water Treatment Rule (LTIESWTR). For systems subject to the IESWTR (systems serving at least 10,000 people, using surface water or ground water under the direct influence of surface water), that use conventional filtration or direct filtration, after January 1, 2002, the turbidity level of a system's combined filter effluent may not exceed 0.3 NTU in at least 95 percent of monthly measurements, and the turbidity level of a system's

combined filter effluent must not exceed 1 NTU at any time. Systems subject to the IESWTR using technologies other than conventional, direct, slow sand, or diatomaceous earth filtration must meet turbidity limits set by the Department. For systems subject to the LTIESWTR (systems serving fewer than 10,000 people, using surface water or ground water under the direct influence of surface water) that use conventional filtration or direct filtration, after January 1, 2005 the turbidity level of a system's combined filter effluent may not exceed 0.3 NTU in at least 95 percent of monthly measurements, and the turbidity level of a system's combined filter effluent must not exceed 1 NTU at any time. Systems subject to the LTIESWTR using technologies other than conventional, direct, slow sand, or diatomaceous earth filtration must meet turbidity limits set by the Department.

⁹ The bacteria detected by heterotrophic plate count (HPC) are not necessarily harmful. HPC is simply an alternative method of determining disinfectant residual levels. The number of such bacteria is an indicator of whether there is enough disinfectant in the distribution system.

¹⁰ SWTR, IESWTR, and LTIESWTR treatment technique violations that involve turbidity exceedances may use the health effects language for turbidity instead.

¹¹ These arsenic values are effective January 23, 2006. Until then, the MCL is 0.05 mg/L and there is no MCLG.

¹² Millions fibers per liter.

¹³ Action Level = 0.015 mg/L

¹⁴ Action Level = 1.3 mg/L

¹⁵ Millirems per years

¹⁶ Picocuries per liter

¹⁷ The uranium MCL is effective December 8, 2003 for all community water systems.

¹⁸ Surface water systems and ground water systems under the direct influence of surface water are regulated under R.61–58.10. Community and non-transient non-community systems serving greater than, or equal to 10,000 must comply with R.61–58.13 DBP MCLs and disinfectant maximum residual disinfectant levels (MRDLs) beginning January 1, 2002. All other community and non-transient non-community systems must comply with R.61.58.13 DBP MCLs and MRDLs beginning January 1, 2004. Transient non-community surface water systems and ground water systems under the direct influence of surface water serving 10,000 or more persons and using chlorine dioxide as a disinfectant or oxidant must comply with the chlorine dioxide MRDL beginning January 1, 2002. All other transient non-community systems that use chlorine dioxide as a disinfectant or oxidant must comply with the chlorine dioxide MRDL beginning on January 1, 2004.

¹⁹ Community and non-transient non-community systems that must comply with R.61–58.14 TTHM and HAA5 MCLs of 0.080 mg/L and 0.060 mg/L, respectively (with compliance calculated as a locational running annual average) on the schedule in R.61–58.15.

²⁰ The MCL for total trihalomethanes is the sum of the concentrations of the individual trihalomethanes.

²¹ The MCL for haloacetic acids is the sum of the concentrations of the individual haloacetic acids.

²² MRDLG—Maximum residual disinfectant level goal.

²³ MRDL—Maximum residual disinfectant level.

HISTORY: Amended by State Register Volume 26, Issue No. 12, eff December 27, 2002; State Register Volume 27, Issue No. 9, eff September 26, 2003; State Register Volume 28, Issue No. 1, eff January 23, 2004; State Register Volume 30, Issue No. 10, eff October 27, 2006; State Register Volume 32, Issue No. 4, eff April 25, 2008; State Register Volume 38, Issue No. 9, Doc. No. 4469, eff September 26, 2014; SCSR 46–12 Doc. No. 5135, eff December 23, 2022.

APPENDIX C. LIST OF ACRONYMS USED IN PUBLIC NOTIFICATION REGULATION

CCR	Consumer Confidence Report
CWS	Community Water System
DBP	Disinfection Byproduct
EPA	Environmental Protection Agency
FBR	Filter Backwash Recycle Rule
GWR	Ground Water Rule
HPC	Heterotrophic Plate Count
IESWTR	Interim Enhanced Surface Water Treatment Rule

IOC	Inorganic Chemical
LCR	Lead and Copper Rule
LT1ESWTR	Long Term 1 Enhanced Surface Water Treatment Rule
MCL	Maximum Contaminant Level
MCLG	Maximum Contaminant Level Goal
MRDL	Maximum Residual Disinfectant Level
MRDLG	Maximum Residual Disinfectant Level Goal
NCWS	Non-Community Water System
NPDWR	National Primary Drinking Water Regulation
NTNCWS	Non-Transient Non-Community Water System
NTU	Nephelometric Turbidity Unit
OGWDW	Office of Ground Water and Drinking Water
OW	Office of Water
PN	Public Notification
PWS	Public Water System
SDWA	Safe Drinking Water Act
SMCL	Secondary Maximum Contaminant Level
SOC	Synthetic Organic Chemical
SPDWR	State Primary Drinking Water Regulations
SWTR	Surface Water Treatment Rule
TCR	Total Coliform Rule
TT	Treatment Technique
TWS	Transient Non-Community Water System
VOC	Volatile Organic Chemical

HISTORY: Amended by State Register Volume 26, Issue No. 12, eff December 27, 2002; State Register Volume 32, Issue No. 4, eff April 25, 2008.

61–58.7. Operation and Maintenance.

Table of Contents

- A. Applicability
- B. General Requirements for Operation and Maintenance of Public Water Systems
- C. Surface Water Treatment Plants
- D. Groundwater Sources and Treatment Plants
- E. Distribution Systems and Storage Tanks
- F. Cross Connection Control
- G. Operation and Maintenance Requirements for Drinking Water Vending Machines and Dispensing Stations
- H. Operating and Monitoring Requirements for Bottled Water Plants

A. Applicability.

This regulation applies to all public water systems, no matter when constructed, and establishes minimum requirements for the operation and maintenance of the system in order to ensure the delivery of safe, potable water to the public. Existing systems may be required to upgrade to comply with regulations 61-58.2, 58.3, or 58.4:

- (1) when no construction permit exists, or;

(2) when required by the Department as the result of a sanitary survey.

B. General Requirements for Operation and Maintenance of Public Water Systems.

(1) All water systems must be operated and maintained in accordance with their construction and operating permit(s) and any approved modifications.

(2) Each system shall have and maintain up-to-date written Standard Operating Procedures for the operation and maintenance of its system. These procedures shall include but not be limited to:

(a) detailed instructions for the operation of all major components of the water system, including wells and/or intakes, pumps, chemical feed equipment, etc.

(b) detailed instructions on starting and stopping any treatment plant;

(c) preventive maintenance schedules on equipment;

(d) reporting and public notification requirements;

(e) water quality monitoring, including frequency of monitoring and sampling and analytical procedures for any monitoring conducted by the water system;

(f) sample siting plans;

(g) disinfection requirements for the new construction of, or the repair of, wells, tanks and water lines;

(h) valve and fire hydrant maintenance;

(i) distribution system flushing program;

(j) leak detection and repair program;

(k) cross connection control program; and,

(l) safety procedures.

(3) All chemical feed systems that are in operation shall be monitored as often as necessary to ensure proper operation. Documentation must be maintained.

(4) The water from each treatment process shall be sampled and analyzed as often as necessary to ensure that the treatment process is functioning properly, but in no case less than once a day. The operator shall maintain a written record of all analyses conducted. These records shall be kept for a minimum of three (3) years. Except where otherwise noted, any analyses conducted for compliance with the monitoring requirements of R.61-58.5, R.61-58.10, R.61-58.11 and R.61-58.13, shall be performed by a laboratory certified by the Department and the records of these analyses kept on file in accordance with the retention schedules outlined in the regulations. All other monitoring conducted for the purpose of process control shall be performed using equipment and methodology acceptable to the Department.

(5) If a combined phosphate or poly-phosphate chemical is used, total phosphate residual monitoring may be conducted once every two weeks in lieu of the daily monitoring as required in R.61-58.7(B)(4).

(6) The operator shall measure the amounts of chemicals used each day and calculate the dosages. The operator shall maintain a written record of all measurements and dosage calculations. These records shall be kept for a minimum of 3 years.

(7) The system shall have immediate access to parts for routine repairs and shall repair any malfunctioning equipment as soon as possible.

(8) Chemical spills shall be cleaned up promptly and disposed of properly. Any chemical spills which are not contained and reach the environment shall be reported to the Department immediately.

(9) Where chlorine gas is used, the following shall apply:

(a) Chlorine gas feed and storage rooms shall be maintained in a reasonably air tight condition. The louvers on the air inlet and on the discharge side of the ventilating fan shall be maintained to ensure proper closure when the fan is not in use. Weather stripping on the door shall be maintained in good condition and no opening shall be allowed to exist between the rooms and other parts of the treatment plant. If a floor drain is provided, a water seal or removable plug must be maintained to prevent escaped gases from exiting through the building sewer.

(b) The doors to the chlorine gas feed and storage rooms shall be kept closed except while being occupied by authorized personnel.

(c) The chlorine gas feed and storage rooms shall be well lighted.

(d) Ammonia shall not be stored in the same room with chlorine gas cylinders or feed equipment.

(e) The ventilating fans for the chlorine gas feed and storage rooms shall work properly at all times, and be manually controlled only. If the fans should ever malfunction, they shall be repaired or replaced promptly.

(f) The vents from the feeders and storage shall be maintained free of any debris.

(g) All cylinders (full and empty) shall be restrained.

(h) The chlorinator room shall be heated to maintain proper temperature for operation.

(i) There shall be no equipment housed in the chlorine feed room except chlorinators, chlorine cylinders, weighing scales, heater, ventilation fan, light(s), chlorine gas leak detector(s), and chlorinator appurtenances.

(j) Scales for weighing cylinders shall be calibrated yearly and properly maintained.

(k) The chlorine feed system shall be operated to ensure continuous feed of chlorine when the plant is operating.

(l) A chlorine leak detection and alarm system shall be in service at all times.

(m) The public water system shall have an emergency action plan for addressing chlorine leaks.

(10) Where ammonia gas is used, the following shall apply:

(a) Ammonia gas feed and storage rooms shall be maintained in a reasonably air tight condition. The louvers on the air inlet and on the discharge side of the ventilating fan shall be maintained to ensure proper closure when the fan is not in use. Weather striping on the door shall be maintained in good condition and no opening shall be allowed to exist between the rooms and other parts of the treatment plant.

(b) The doors to the ammonia gas feed and storage rooms shall be kept closed except while occupied by authorized personnel.

(c) The ammonia gas feed and storage rooms shall be well lighted.

(d) The ventilating fans for the ammonia gas feed and storage rooms shall work properly at all times, and be manually controlled only. If the fans should ever malfunction, they shall be repaired or replaced promptly.

(e) Chlorine shall not be stored in the same room with ammonia gas cylinders or feed equipment.

(f) The vents from the feeders and storage shall be maintained free of any debris.

(g) All cylinders (full and empty) shall be restrained.

(h) The ammoniator room shall be heated to maintain proper temperature for operation.

(i) There shall be no equipment housed in the ammonia feed room except ammoniators, ammonia cylinders, weighing scales, heater, ventilation fan, light(s), ammonia gas leak detector(s), and ammoniator appurtenances.

(j) Scales for weighing cylinders shall be calibrated yearly and properly maintained. Where bulk storage tanks are installed a pressure gauge shall be maintained.

(k) The ammonia feed system shall be maintained and operated to ensure continuous feed of ammonia when the plant is operating.

(l) An ammonia leak detection and alarm system shall be in service at all times.

(m) The public water system shall have an emergency action plan for addressing ammonia leaks.

(11) Where fluoride is added to the water the following shall apply:

(a) The fluoride content of the water shall be maintained between eight-tenths (.80) and one and two-tenths (1.20) milligrams per liter.

(b) Finished water shall be analyzed daily for fluoride content in accordance with methodology specified in Section C(17) of R.61-58.5.

(c) Should a public water system cease fluoridating for any reason the Department shall be notified immediately.

(d) A public water system which fluoridates must notify their service population and all local dental and public health practices prior to ceasing fluoridation.

(12) Adequate safety equipment for handling of chemicals used in treatment shall be provided.

(13) Chemical dosages shall not exceed the maximum dosage specified by the Department.

(14) All emergency power equipment shall be operated at least once per month under load and records of this operation kept on file with the water system.

(15) All chemicals and products added to a public water supply as part of the treatment process shall be certified as meeting the specifications of the American National Standard Institute/National Sanitation Foundation Standard 60, Drinking Water Treatment Chemicals—Health Effects. The certifying party shall be accredited by the American National Standards Institute.

(16) All materials and products installed in a public water system after December 31, 1995, which comes into contact with drinking water during the treatment, storage, transmission or distribution of the water, shall be certified as meeting the specifications of the American National Standard Institute/National Sanitation Foundation Standard 61, Drinking Water System Components—Health Effects. The certifying party shall be accredited by the American National Standards Institute.

(17) All storage and de-watering facilities for water treatment plant residuals shall be maintained in good operating condition. Equipment shall be cleaned and lubricated according to manufacturer's recommendations and the operation and maintenance manual for the plant. Records shall be kept of maintenance performed. There shall be no bypassing of any treatment process to the environment. The facilities shall be monitored in accordance with any operating permit(s) issued by the Department.

(18) Security shall be provided and maintained for all intake, treatment, storage and pumping facilities so as to prevent the entrance of unauthorized persons.

(19) Sampling taps shall be maintained so that representative water samples can be obtained from:

(a) each raw water source;

(b) appropriate locations throughout the treatment process so that the operator can maintain proper control of the treatment process;

(c) effluent from each filter and the combined filter effluent prior to any post chemical addition;

(d) the entry point(s) to the distribution system

(20) All required flow meters shall be maintained and operated in accordance with design criteria.

(21) Secondary containment systems shall be maintained for all liquid chemical storage tanks and solution tanks, capable of receiving and containing accidental spills or overflows. Incompatible chemicals shall not be stored in the same secondary containment area.

C. Surface Water Treatment Plants.

(1) All surface water treatment plants shall have an operator of the appropriate grade present at the plant and responsible for its operation, when the plant is producing water for public consumption.

(2) All enclosed filters shall be opened and inspected per manufacturer's recommendation or as required to ensure proper operation.

(3) All water, chemical and waste lines shall be labeled and color coded to identify line contents and direction of flow (if applicable).

(4) The treatment facility shall be operated such that the Department approved filtration rate is not exceeded at any time, and the pretreatment retention times are not reduced below those times approved by the Department. The treatment facility shall be operated such that hydraulic surges through the filters are minimized during flow rate changes and when filters are removed from service for backwashing.

(5) The use of chemicals for the control of aquatic weeds, algae and water borne organisms in rivers, lakes and reservoirs which are used as a source of water by a public water supply, shall be approved by the Department prior to their use.

(6) Intake screens shall be cleaned as often as is necessary for the proper functioning of the intake station.

(7) All plants shall have an on-site laboratory with the necessary equipment and methodology acceptable to the Department for process control monitoring. If the on-site laboratory is to conduct any analyses for compliance with the monitoring requirements of R.61-58.5, R.61-58.10, R.61-58.11 and R.61-58.13, it must be certified by the Department.

(8) The following analyses shall be conducted as often as necessary, but no less than once a day, to ensure the treatment plant is functioning properly.

(a) Raw water shall be analyzed for pH, alkalinity, temperature, turbidity and total or fecal coliform bacteria.

(b) The coagulated water shall be analyzed for pH and alkalinity. If a pre-disinfectant and/or oxidant is added, the coagulated water shall be analyzed for the disinfectant and/or oxidant.

(c) The settled water shall be analyzed for turbidity and for disinfectant residual if a pre-disinfectant is used. If the pretreatment unit is used as a disinfectant sequence, the disinfectant concentration, pH and water temperature shall be measured in accordance with the requirements of R.61-58.10 for calculating CT values.

(d) The filtered water shall be analyzed for turbidity. If a pre-filter disinfectant is used, the filtered water disinfectant residual shall be measured.

(e) The finished water (water entering distribution system) shall be analyzed for pH, alkalinity, temperature, disinfectant residual, calcium hardness and turbidity.

(f) The system shall analyze for any additional parameter that the Department may require for a specific plant for special concerns.

(9) The effluent weirs of the sedimentation basins shall be maintained so there is a uniform flow of water over the entire length of the weir.

(10) Flocculation and sedimentation basins and clarifiers shall be cleaned as often as necessary to keep the settled material and algae growths to a minimum.

(11) The reliable capacity of a surface water treatment plant shall be based on the lowest capacity in the treatment train. This shall include, but not be limited to, the capacity of the source, capacity of the raw water pump station with the largest pump out of service, capacity of the rapid mix chamber(s), flocculator(s), sedimentation basin(s), clarifier(s) and filters(s) and the capacity of the high service pump station with the largest pump out of service. If the reliable capacity of a plant is exceeded on a consistent basis during the peak water use months, the Department may elect not to issue any construction permits for new water line construction until the reliable capacity of the plant is increased.

(12) When the average daily demand during any month exceeds eighty (80) percent of the public water system's reliable capacity, as specified in R.61-58.7.C(11), the system shall submit a preliminary engineering report to the Department within one hundred eighty (180) days addressing in detail any upgrade necessary to keep up with any growth in demand on the system. When the average daily demand during any month exceeds ninety (90) percent of the public water system's reliable capacity as specified in R.61-58.7.C(11), the system shall submit to the Department plans and specifications along with an application for a permit to construct the upgrade within one hundred eighty (180) days, unless a longer time period is specified by the Department.

D. Groundwater Sources and Treatment Plants.

(1) All well heads and associated piping shall be inspected at a minimum of once a week. Stand-by wells shall be inspected and exercised at least quarterly. Documentation of these inspections must be maintained.

(2) All groundwater treatment plants shall be monitored by an operator of the appropriate grade, at a frequency to ensure proper operation, but in no case less than once a day. Such monitoring may

be accomplished through site visits and/or remote monitoring equipment approved by the Department.

(3) All pressure filters and enclosed aeration devices shall be opened and inspected per manufacturer's recommendation or as required to ensure proper operation.

(4) Valves provided for the isolation of each well shall be maintained to ensure proper operation.

(5) The check valve and blow-off on the well head piping shall be maintained.

(6) Adequate freeze protection for the well head piping shall be maintained.

(7) A flow meter shall be maintained for each well serving a community water system and each well which is equipped with chemical treatment. The meter shall be periodically calibrated to ensure accuracy in accordance with the manufacturer's recommendations. Calibration records shall be kept on file for a minimum of three (3) years.

(8) Drainage systems shall be maintained so that surface water flows away from the well head.

(9) All wells shall be maintained so the sanitary seal, the casing, the screened vent and the concrete pad are in good repair and can prevent the entrance of contamination into the well.

(10) If a well is no longer used, does not meet the requirements of a stand-by or emergency well, and is not converted to another active use (e.g. irrigation), it shall be properly abandoned in accordance with R.61-58.2.B(15).

(11) Public water systems using ground water as its drinking water source shall maintain compliance with R.61-58.2B(1).

(12) The capacity of a public water system which uses groundwater as its only drinking water source, shall be based on all operable wells pumping 16 hours a day or all operable wells minus the largest well pumping 24 hours a day, whichever is less. If the system has an additional source (surface water plant or metered connection from another public water system), the additional capacity from that source shall be used in determining the total capacity of the system. If the capacity of the system is exceeded on a consistent basis during the peak water use months, the system shall submit a preliminary engineering report to the Department within ninety (90) days addressing in detail any upgrade necessary to keep up with any growth in demand on the system. Construction plans and specifications for a new well may be submitted in lieu of the preliminary engineering report. In addition, the Department may elect not to issue any construction permits for new water line construction until the capacity of the system is increased.

(13) The public water system shall conduct monitoring as specified in R.61-58.2(B)(14)(c) when required by the Department to determine if the ground water source is under the direct influence of surface water.

(14) Stand-by wells must be exercised and sampled for total coliform on at least a quarterly basis. In addition, stand-by wells must be sampled annually for nitrate and nitrite. This monitoring is conducted by the water system and records must be maintained for Department inspection. Whenever a stand-by well is put in service, the system must notify the Department as soon as possible, but in no case later than the end of the next business day.

(15) Emergency wells must be exercised on an annual basis to ensure that they are operable. Whenever an emergency well is placed into service, the system must notify the Department as soon as possible, but in no case later than the end of the next business day. In addition, the system must immediately issue a Boil Water Advisory for all portions of the system being served by the emergency well.

E. Distribution Systems and Storage Tanks.

(1) Operator Certification

(a) All distribution treatment plants (e.g. booster chlorination stations) shall be monitored by an operator of appropriate grade, at a frequency to ensure proper operation, but in no case less than once a day. Such monitoring may be accomplished through site visits and/or remote monitoring equipment approved by the Department

(b) All community and non-transient non-community water systems must designate an operator(s) of appropriate grade as the operator responsible for the operation and maintenance of their distribution system.

(c) All community and non-transient non-community water systems must be operated such that all personnel making decisions which could affect water quality, water quantity, or distribution system integrity be certified distribution system operators. Certified water treatment plant operators that make such decisions as a part of their routine treatment plant operation duties (e.g. starting and stopping distribution pumps) are not required to have dual certification.

(2) All elevated, hydropneumatic and ground storage tanks shall be inspected at a minimum of once a week for the purpose of checking on the security of the tank(s) and insuring that proper air/water ratios are being maintained in hydropneumatic storage tanks. Vent screens, hatches and other openings on atmospheric tanks must be inspected annually to ensure sanitary protection.

(3) The drainage system on any storage tank lot shall be maintained to channel water away from the tank foundations.

(4) Valves provided for the isolation of each tank shall be maintained to ensure proper operation.

(5) Screens shall be maintained on all storage tank vents.

(6) Screens or flap valves shall be maintained on all storage tank overflows.

(7) The minimum pressure in the distribution system under normal operating conditions shall be twenty-five (25) pounds per square inch at a customer's service connection. A minimum pressure of twenty (20) pounds per square inch shall be maintained at all service connections during unusually heavy flows (i.e., fire or flushing).

(8) Each public water system shall maintain a map of the distribution system which shows the location of water lines and their sizes as well as the location of all valves, hydrants and blow-offs. The location of all water sources and all pumping, treatment and storage facilities shall also be included on this map.

(9) Valves and hydrants shall be exercised and maintained in accordance with the system's valve and hydrant maintenance program to ensure operability. Any valves or hydrants that malfunction shall be repaired promptly. Records shall be kept on this maintenance program.

(10) A flow test shall be conducted on all fire hydrants at a minimum of once every three years. The flow from the hydrant shall be measured and recorded along with the static and residual pressure and time of day the test was conducted. The system shall keep a record of the latest test of each hydrant on file.

(11) All community water systems shall initiate and carry out a program aimed at detecting leaks in the distribution system. At a minimum, a leak detection program shall include a comparison of water produced to water sold or used for other purposes. Any leaks found through this program or any leaks discovered through other means shall be repaired promptly. Records shall be kept of the leaks detected and the repairs made.

(12) When a break occurs in a system's distribution line, the repairs to that line must be made promptly and in accordance with good sanitary practices. Precautions shall be taken throughout the repair process to make sure that customers affected by the break will be assured of safe water after the line is placed back into service.

(13) All public water systems shall develop and maintain a flushing program in order to prevent customer complaints caused by stagnant, discolored, and sediment laden water and maintain adequate disinfectant residuals throughout the distribution system. Detailed instructions of this program shall be included in the system's manual of standard operating procedures. Records of all flushing activities shall be maintained by the system.

(14) The Department shall be notified in writing at least ten (10) days prior to the repainting of the interior or exterior of any storage tank. All interior paint coatings shall be certified as meeting ANSI/NSF Standard 61.

(15) A storage tank that is drained for any reason must be properly disinfected and satisfactory bacteriological samples must be obtained prior to placing it back into service.

(16) The Department shall be notified in writing at least thirty (30) days prior to the entry of an underwater diver into a finished water storage tank for the purpose of inspecting or cleaning of the tank.

F. Cross Connection Control

(1) General

(a) All public water systems shall initiate and maintain a viable cross connection control program. Such a program shall consist of:

- (i) Locating and eliminating unprotected cross connections.
- (ii) Maintaining records pertaining to the location of existing backflow prevention assemblies, type and size of each assembly and test results.

(b) No person shall install, permit to be installed or maintain any cross connection between a public water system and any other non-public water system, sewer or a line from any container of liquids or other substances, unless an approved backflow prevention device or assembly is installed between the public water system and the source of contamination.

(2) Low Hazard Cross Connections

A connection between an approved public water system and another water source not hazardous to health but not meeting the standards of the approved public water system and not cross-connected within its system with a potentially dangerous substance shall be considered a low hazard category cross connection. At a minimum, an approved Double Check Valve Assembly or Pressure Vacuum Breaker must be installed on a low hazard cross connection except as provided for in section 3 below.

(3) Residential Lawn Irrigation Systems

(a) Low hazard residential lawn irrigation systems - Each public water system which has low hazard residential irrigation systems directly or indirectly connected to their public water system must have a written low hazard residential lawn irrigation system cross connection control policy. This policy must be documented in writing and must be approved by the governing body of the public water system. The policy must specify the minimum acceptable device for low hazard residential lawn sprinkler systems. The minimum acceptable device for low hazard residential lawn sprinkler systems is a residential dual check. If a water system specifies another backflow prevention assembly as the minimum acceptable protection for these cross connections, the policy must be approved by the governing body of the public water system with due opportunity being provided for public comment and participation. The written policy must:

- (i) identify the type of backflow prevention device or assembly that is required to be installed on low hazard residential lawn irrigation system connections.
- (ii) establish a schedule for the required testing of double check valve assemblies, or other testable assembly, if testable assemblies are designated by the policy as minimum acceptable protection for low hazard residential lawn irrigation systems. The minimum testing frequency must be specified in the policy and appropriate records must be maintained to verify compliance with the established testing requirements.
- (iii) establish a schedule for the required change out of residential dual checks if these are the devices designated by the policy as minimum acceptable protection for low hazard residential lawn irrigation systems. The minimum change out frequency must be specified in the policy and appropriate records must be maintained to verify compliance with the established change out requirements.

(b) High hazard residential lawn irrigation systems - Any residential lawn irrigation system that includes chemical addition, or is also connected to another water source which is not an approved public water system, shall be considered a high hazard cross connection and must meet the requirements of paragraph (4) below.

(4) High Hazard Cross Connections

(a) A connection between an approved public water system and a service or other water system which has or may have any material in the water dangerous to health, or connected to any material dangerous to health, that is or may be handled under pressure, or subject to negative pressure, shall be considered a high hazard category cross connection. Protection shall be by air gap separation or an approved reduced pressure principle backflow prevention assembly.

(b) Reduced pressure principle backflow prevention assemblies shall not be installed in any location subject to possible flooding. This includes pits or vaults which are not provided with a

gravity drain to the ground's surface that is capable of exceeding the discharge rate of the relief valve.

(5) Fire Sprinkler Systems

Fire line sprinkler systems, except those in the high hazard category shall be protected by an approved double check valve assembly. High hazard category fire sprinkler systems shall include, but not be limited to: antifreeze systems, foam systems, systems charged from or tied into ponds, lakes, streams, or any water source other than the approved public water supply. High hazard category fire sprinkler systems shall comply with the requirements of Paragraph (4) above.

(6) Approved Devices and Assemblies

The Department shall prepare and publish a list of backflow prevention assemblies approved by the Department for use in South Carolina, and this list shall be updated at least once annually.

(7) Testing Requirements

When double check valve assemblies, pressure vacuum breakers, and/or reduced pressure principal backflow prevention assemblies are installed to protect a public water system against the possibility of backflow from a customer's water service, routine testing of the assemblies shall be performed by a certified tester.

(a) Each assembly shall be tested by a certified tester after installation and before use by the customer. Except as specified in paragraph 3(a)(ii) above, each assembly shall be tested at least once annually by a certified tester.

(b) The public water system is to receive a written report of the inspection and testing results for all assemblies tested within its distribution system. The report shall be submitted by the certified tester making the inspection and test.

(c) All backflow prevention assemblies shall be tested immediately after repairs of any kind are made to the assembly.

(8) Backflow Prevention Tester Certification

There are four (4) types of certified testers of backflow prevention assemblies: General Tester, Limited Tester, Inspector Tester and Manufacturer's Agent. The definition of each type of certified tester is specified in R.61-58(A).

(a) Each certified tester's license shall expire three (3) years from the date of issue. In order to renew this certification for three (3) more years, the tester shall come before a designated person approved by the Department and shall successfully complete a written examination with a passing score of 70%, and perform the prescribed test on an approved reduced pressure principal backflow prevention assembly, double check valve assembly, and a pressure vacuum breaker using the tester's own differential pressure gauge. The gauge must be accurate within 2% of full scale or plus or minus 0.3 pounds per square inch differential (PSID). Any gauge found to be inaccurate or malfunctioning will be required to be calibrated or repaired as needed to bring it into compliance before certification will be renewed.

(b) Any applicant for certification who fails to properly perform the above prescribed tests will have his certification revoked immediately and will have to successfully complete the state sponsored backflow prevention training and certification course in order to become re-certified as a tester of backflow prevention assemblies in South Carolina.

(c) A certified tester may have his tester's certification revoked due to incompetence or falsification of test results, as determined by the Department.

(d) The Department shall reserve the right to charge or allow for the charge of a nominal fee for the administration of the recertification of testers. This fee shall not exceed fifty dollars (\$50.00).

(9) Installation of Pressure Vacuum Breakers

Where used, pressure vacuum breakers shall be installed at a minimum of twelve (12) inches above the highest downstream piping and shall not be subject to backpressure.

G. Operation and Maintenance Requirements for Drinking Water Vending Machines and Dispensing Stations.

(1) All drinking water vending machines and dispensing stations shall be monitored by an operator who holds a valid Bottle Water Class Operator's Certificate issued by the Department of Labor, Licensing and Regulation, at a frequency to ensure proper operation. Dispensing stations shall be inspected by the operator no less than once a week.

(2) Records shall be kept of each visit by the operator and any other maintenance personnel under the direct supervision of the operator. The records shall show the date and time of the visit, any tests performed, any maintenance performed, and the signature of the operator or maintenance personnel. These reports must be kept by the owner of the vending machine or dispensing station for minimum of two (2) years. These records shall be made available to the Department upon request.

(3) A twenty-four (24) hour telephone number shall be clearly posted on the front of each machine or dispensing station for use in emergencies or for consumer complaints. A record of any consumer complaints shall be kept on file with the owner of the machine for a minimum of three years, and shall be made available to the Department upon request.

(4) Each machine will be considered a transient non-community water system and shall comply with the monitoring requirements of R.61.58.5.

(5) Vending machines shall be operated and maintained in accordance with the manufacturer's recommendations.

H. Operating and Monitoring Requirements for Bottled Water Plants.

(1) All bottled water treatment plants shall be monitored on a daily basis by an operator of the appropriate grade to insure proper operation. This monitoring must be by site visitation. No remote monitoring shall be allowed.

(2) All sources used by bottled water plants in the State shall be approved by Department prior to their use. These sources shall be monitored on an annual basis for all contaminants specified in R.61-58.5, R.61-58.10, and R.61-58.11. The results of this monitoring shall be submitted to the Department by the January 10th following the year for which the monitoring is conducted. If the source is from the distribution system of existing public water system in the State, this monitoring is not required. However, the operator of such a bottled water plant shall hold a valid Bottle Water Class Operator's Certificate issued by the Department of Labor, Licensing and Regulation.

(3) No surface water sources or groundwater sources under the direct influence of surface water shall be used for bottled water unless the requirements of R.61-58.10 are met.

I. Operation and Maintenance of Aquifer Storage and Recovery (ASR) Wells.

(1) All ASR wells must be operated and maintained in accordance with their construction and operating permits(s) and any approved modifications.

(2) The Department may require routine testing of specific water quality parameters. Results of such testing must be submitted to the Department upon request or at a frequency established by the Department.

(3) Records must be kept of total flow volume into and out of an ASR well. Such records must be submitted to the Department upon request or at a frequency established by the Department.

(4) For the purposes of determining compliance with R.61-58.7.C(12) and R.61-58.7.D(12), the Department may consider up to ninety (90) percent of the water stored in an ASR well(s) as an additional source of water in lieu of requiring the expansion of existing sources or treatment facilities or the development of new sources or treatment facilities on a case-by-case basis.

HISTORY: Amended by State Register Volume 19, Issue No. 7, eff July 28, 1995; State Register Volume 24, Issue No. 2, eff February 25, 2000; State Register Volume 25, Issue No. 9, eff September 28, 2001; State Register Volume 26, Issue No. 5, Part 1, eff May 24, 2002; State Register Volume 29, Issue No. 4, eff April 22, 2005.

61-58.8. Emergency Procedures.

Table of Contents

- A. Applicability
- B. Emergency Preparedness Plan.
- C. Operation Under Emergency Conditions.

D. Withdrawals of Surface Water and Groundwater During Drought and Other Emergency Conditions

A. Applicability.

This regulation establishes the minimum requirements that must be met by all public water systems prior to, during and after an emergency.

B. Emergency Preparedness Plan.

(1) Each public water system shall maintain an up-to-date copy of the Emergency Preparedness Plan at a location that is readily accessible in the event of an emergency.

(2) Each public water system shall conduct an assessment outlining the critical parts of the water system, i.e., raw water, treatment, storage, power sources.

(3) Each community water system shall develop an Emergency Preparedness Plan which shall, as a minimum, contain the following:

(a) the telephone number of the Department's District Office, the Department's drinking water program office and the Department's twenty-four (24) hour telephone number;

(b) the name and telephone number of:

(i) the County Emergency Preparedness Representative;

(ii) the local law enforcement and highway patrol offices; and,

(iii) the local fire department(s) and Emergency Medical Service (EMS);

(c) the telephone number of the State Emergency Preparedness Office;

(d) the names and telephone numbers of the water system's personnel who should be notified in the event of an emergency;

(e) the locations and telephone numbers of primary and secondary command posts that may be utilized in the event of emergency;

(f) the names and telephone numbers of current chemical suppliers;

(g) the names and telephone numbers of the electric power, natural gas, telephone and cable companies, and if available, the locator service in the area;

(h) the names and telephone numbers of critical users and the priority of service to each one, i.e., dialysis patients, hospitals, etc.;

(i) the names and telephone numbers of potential sources of spare parts, pipe sections, repair clamps;

(j) the names, addresses and telephone numbers of equipment suppliers and contacts for equipment repair, i.e. rewinding of motors, pump shaft repairs;

(k) a list of any mutual aid agreements among water systems, such as emergency connections, personnel, equipment and chemical supplies;

(l) the names, addresses and telephone numbers of contractors to call for making any repairs beyond the capability of the systems personnel;

(m) the names and telephone numbers of well drillers (if applicable);

(n) the names and telephone numbers of other sources of assistance such as engineers, laboratories;

(o) arrangements for obtaining emergency power;

(p) arrangements for obtaining potable water;

(q) an up-to-date distribution map showing line sizes and the location of all valves, fire hydrants, blow-offs and pumping, storage and treatment facilities. If the map is too large to include in the plan, the plan must reference its location;

(r) notification procedures to the public and media and example notices to be issued, such as notices instructing customers to boil their water prior to consumption; and,

(s) emergency disinfection procedures for wells (if applicable), water lines and storage tanks;

(4) Each non-community water system shall develop an Emergency Preparedness Plan which shall, as a minimum, contain the following:

(a) the telephone number of the Department's District Office, the Department's drinking water program office and the Department's twenty-four (24) hour telephone number;

(b) the names and telephone numbers of current chemical suppliers;

(c) the names and telephone numbers of the electric power, natural gas and telephone companies;

(d) the names and telephone numbers of potential sources of spare parts, pipe sections, repair clamps;

(e) the names, addresses and telephone numbers of equipment suppliers and contacts for equipment repair, i.e., rewinding of motors, pump shaft repairs;

(f) the names, addresses and telephone numbers of plumbing contractors to call for making necessary repairs;

(g) the names and telephone numbers of well drillers (if applicable);

(h) the names and telephone numbers of other sources of assistance such as engineers, laboratories;

(i) arrangements for obtaining emergency power;

(j) arrangements for obtaining potable water;

(k) an up-to-date distribution map showing line sizes and the location of all valves, fire hydrants, blow-offs and pumping, storage and treatment facilities;

(l) notification procedures to employees and the public and example notices to be issued; and,

(m) emergency disinfection procedures for wells (if applicable), water lines and storage tanks;

C. Operation Under Emergency Conditions.

(1) If the pressure in a distribution system or any significant portion of a distribution system should drop to ten (10) pounds per square inch or less the owner or operator of the system shall notify the Department immediately. Any immediate corrective action necessary to protect public health shall take priority over any notification requirement to the Department.

(2) If a boil water notice or advisory is issued by the public water system, the Department shall be notified immediately. A copy of the boil water notice or advisory and repeal of such shall be forwarded to the Department as soon as possible after each is issued.

(3) If potable drinking water is transported into an area where normal water service has been disrupted, the water shall be transported in a sanitized container or tank truck or trailer which is designed for the transportation of potable water. The disinfectant residual of the transported water at the loading point shall be a minimum of one (1) milligram per liter. The source of water shall be approved by the Department before any water is loaded into a container, tank truck or trailer and transported to the affected area.

(4) If a contaminant is injected or syphoned into the distribution system, the owner or operator of the system shall take necessary actions to remove the contamination from the distribution system as soon as possible. The Department shall be notified as soon as possible of the event and actions taken.

(5) If a contaminant is injected, dumped, discharged, or flushed into surface water or groundwater which serves a public water system, the owner or operator of the system shall take necessary precautions to prevent the contaminant from entering the distribution system.

D. Withdrawals of Surface Water and Groundwater During Drought and Other Emergency Conditions.

(1) Whenever drought or low rainfall conditions reduce the amount of surface and groundwater available for domestic, industrial, agricultural and commercial use, the Department may regulate surface water and groundwater withdrawals in an equitable manner to reduce the adverse impact to the public well being and health.

(2) No person shall withdraw or cause to withdraw water from a surface or groundwater source at such a rate and daily volume as to infringe on the use of said water source by a public water supply.

HISTORY: Amended by State Register Volume 19, Issue No. 7, eff July 28, 1995.

61-58.9. Variances and Exemptions.

Table of Contents

- A. Applicability
- B. Variances
- C. Exemptions
- D. Variances from the Maximum Contaminant Level for Total Trihalomethanes
- E. Variances from the Maximum Contaminant Level for Fluoride
- F. Variances and Exemptions from the Maximum Contaminant Levels for Organic and Inorganic Chemicals and Exemptions from the Treatments Technique for Lead and Copper
- G. Variances and Exemptions from the Maximum Contaminant Levels for Total Coliforms
- H. Variances and Exemptions from the Filtration and Disinfection Requirements
- I. Variances and Exemptions from the Maximum Contaminant Levels for Radionuclides

A. Applicability.

The Department may issue variances and exemptions from the requirements of these primary drinking water regulations under conditions and in a manner which are not less stringent than the conditions under which, and the manner in which, variances and exemptions may be granted under the Federal Safe Drinking Water Act. This regulation shall apply to each public water system, unless the public water system meets all of the following conditions:

- (1) Consists only of distribution and storage facilities (and does not have any collection and treatment facilities);
- (2) Obtains all of its water from, but is not owned or operated by, a public water system to which such regulations apply;
- (3) Does not sell water to any person; and
- (4) Is not a carrier which conveys passengers in interstate commerce.

B. Variances

(1) Requirements for a variance.

(a) The Department may grant one or more variances to any public water system within the State from any requirement respecting a maximum contaminant level of an applicable State primary drinking water regulation upon a finding that:

(i) Because of characteristics of the raw water sources which are reasonably available to the system, the system cannot meet the requirements respecting the maximum contaminant levels of such drinking water regulations despite application of the best technology, treatment techniques, or other means, which the Department finds are generally available (taking costs into consideration); and,

(ii) The granting of a variance will not result in an unreasonable risk to the health of persons served by the system.

(b) The Department may grant one or more variances to any public water system within the State from any requirement of a specific treatment technique or an applicable State primary drinking water regulation upon a finding that the public water system applying for the variance has demonstrated that such treatment technique is not necessary to protect the health of persons because of the nature of the raw water source of such system.

(2) Requests for a variance.

A supplier of water may request the granting of a variance by submitting a request for a variance in writing to the Department. Suppliers of water may submit a joint request for variances when they seek similar variances under similar circumstances. Any written request for a variance or variances shall include the following information:

- (a) The nature and duration of the variance requested.
 - (b) Relevant analytical results of water quality sampling of the system, including results of relevant tests conducted pursuant to the requirements of these regulations.
 - (c) For any request made under paragraph (1)(a) above:
 - (i) Explanation in full and evidence of the best available treatment technology and techniques.
 - (ii) Economic and legal factors relevant to ability to comply.
 - (iii) Analytical results of raw water quality relevant to the variance request.
 - (iv) A proposed compliance schedule, including the date each step toward compliance will be achieved. Such schedule shall include as a minimum the following dates:
 - (A) Date by which arrangement for alternative raw water source or improvement of existing raw water source will be completed.
 - (B) Date of initiation of the connection of the alternative raw water source or improvement of existing raw water source.
 - (C) Date by which final compliance is to be achieved.
 - (v) A plan for the provision of safe drinking water in the case of an excessive rise in the contaminant level for which the variance is requested.
 - (vi) A plan for additional interim control measures during the effective period of variance.
 - (d) For any request made under paragraph (1)(b) above, a statement that the system will perform monitoring and other reasonable requirements prescribed by the Department as a condition to the variance.
 - (e) Other information, if any, believed to be pertinent by the applicant.
 - (f) Such other information as the Department may require.
- (3) Consideration of a variance request.
- (a) The Department will act on any variance request submitted pursuant to paragraph (2) above within 90 days of receipt of the request.
 - (b) In its consideration of whether the public water system is unable to comply with a contaminant level required by these regulations because of the nature of the raw water source, the Department will consider such factors as the following:
 - (i) The availability and effectiveness of treatment methods for the contaminant for which the variance is requested.
 - (ii) Cost and other economic considerations such as implementing treatment, improving the quality of the source water or using an alternate source.
 - (c) A variance may be issued to a system only after the system's application of the best technology, treatment techniques, or other means, which the Department finds are available (taking costs into consideration).
 - (d) In its consideration of whether a public water system should be granted a variance to a required treatment technique because such treatment is unnecessary to protect the public health, the Department will consider such factors as the following:
 - (i) Quality of the water source including water quality data and pertinent sources of pollution.
 - (ii) Source protection measures employed by the public water system.
- (4) Disposition of a variance request.
- (a) If the Department decides to deny the application for a variance, it will notify the applicant of its intention to issue a denial. Such notice will include a statement of reasons for the proposed denial, and will offer the applicant an opportunity to present, within 30 days of receipt of the notice, additional information or argument to the Department. The Department will make a final

determination on the request within 30 days after receiving any such additional information or argument. If no additional information or argument is submitted by the applicant, the application will be denied.

(b) If the Department proposes to grant a variance request submitted pursuant to paragraph (2) above, it shall notify the applicant of its decision in writing. Such notice will identify the variance, the facility covered, and will specify the period of time for which the variance will be effective.

(i) For the type of variance specified in paragraph (1)(a) above, such notice will provide that the variance will be terminated when the system comes into compliance with the applicable regulation, and may be terminated upon a finding by the Department that the system has failed to comply with any requirements of a final schedule issued pursuant to paragraph (5) below.

(ii) For the type of variance specified in paragraph (1)(b) above, such notice will provide that the variance may be terminated at any time upon a finding that the nature of the raw water source is such that the specified treatment technique for which the variance was granted is necessary to protect the health of persons, or upon a finding that the public water system has failed to comply with monitoring and other requirements prescribed by the Department as a condition to the granting of the variance.

(c) For a variance specified in paragraph (1)(a)(i) above, the Department will propose a schedule for:

(i) Compliance (including increments of progress) by the public water system with each contaminant level requirement covered by the variance; and,

(ii) Implementation by the public water system of such additional control measures as the Department may require for each contaminant covered by the variance.

(d) The proposed schedule for compliance will specify dates by which steps toward compliance are to be taken, including at the minimum, where applicable:

(i) The date by which arrangement for an alternative raw water source or improvement of existing raw water source will be completed.

(ii) The date of initiation of the connection for the alternative raw water source or improvement of the existing raw water source.

(iii) The date by which final compliance is to be achieved.

(e) The proposed schedule may, if the public water system has no access to an alternative raw water source and can effect or anticipate no adequate improvement of the existing raw water source, specify an indefinite time period for compliance until a new and effective treatment technology is developed at which time a new compliance schedule will be prescribed by the Department.

(f) The proposed schedule for implementation of additional interim control measures during the period of variance will specify interim treatment techniques, methods and equipment, and dates by which steps toward meeting the additional interim control measures are to be met.

(g) The schedule will be prescribed by the Department at the time of the granting of the variance, subsequent to provision of opportunity for hearing pursuant to paragraph (5) below.

(5) Public notice and opportunity for hearing.

(a) Before a variance and schedule proposed by the Department pursuant to paragraph (4) above may take effect, the Department will provide notice and opportunity for public hearing on the variance and schedule. A notice given pursuant to the preceding section may cover the granting of more than one variance and a hearing held pursuant to such notice will include each of the variances covered by the notice.

(b) Public notice of an opportunity for hearing on a variance and schedule will be circulated in a manner designed to inform interested and potentially interested persons of the proposed variance and schedule, and will include at least the following:

(i) Posting of a notice in the principal post office of each municipality or area served by the public water system, and publishing of a notice in a newspaper or newspapers of general circulation in the area served by the public water system; and,

(ii) Such notice will include a summary of the proposed variance and schedule and shall inform interested persons that they may request a public hearing on the proposed variance and schedule.

(c) Requests for hearing may be submitted by any interested person. Frivolous or insubstantial requests for hearing may be denied by the Department. Requests must be submitted to the Department within 30 days after issuance of the public notice provided for in paragraph (b) of this section. Such requests shall include the following information:

(i) The name, address and telephone number of the individual, organization or other entity requesting a hearing.

(ii) A brief statement of the interest of the person making the request in the proposed variance and schedule, and of information that the requester intends to submit at such hearing.

(iii) The signature of the individual making the request, or, if the request is made on behalf of an organization or other entity, the signature of a responsible official of the organization or other entity.

(d) The Department will give notice of any hearing to be held pursuant to a request submitted by an interested person or on its own motion. Notice will be given and such hearing conducted in accordance with the Department's administrative procedures.

(e) The variance and schedule will become effective 30 days after notice of opportunity for hearing is given pursuant to paragraph (b) of this section if no timely request for a hearing is submitted and the Department does not determine to hold a public hearing on its own motion.

(6) Action after hearing. If a public hearing is held pursuant to paragraph (5) above, the Department will take into consideration information obtained during such hearing and confirm, revise or rescind the proposed variance and schedule.

(7) Variance for alternative treatment techniques. The Department may grant a variance from any treatment technique requirement of a state primary drinking water regulation to a supplier of water upon a showing from the supplier that an alternative treatment technique not included in such requirement is at least as efficient in lowering the level of the contaminant with respect to which such requirement was prescribed. A variance under this paragraph shall be conditioned on the use of the alternative treatment technique which is the basis of the variance.

C. Exemptions

(1) The Department may exempt any public water system within the State from any requirement respecting a maximum contaminant level or any treatment technique requirement, or from both, of an applicable state primary drinking water regulation upon a finding that:

(a) Due to compelling factors (which may include economic factors), the public water system is unable to comply with such contaminant level or treatment technique requirement;

(b) The public water system was in operation on the effective date of such contaminant level or treatment technique requirement; and,

(c) The granting of the exemption will not result in an unreasonable risk to health.

(2) Requests for an exemption.

A supplier of water may request the granting of an exemption by submitting a request for exemption in writing to the Department. Suppliers of water may submit a joint request for exemptions when they seek similar exemptions under similar circumstances. Any written request for an exemption shall include the following information:

(a) The nature and duration of exemption requested.

(b) Relevant analytical results of water quality sampling of the system, including results of relevant tests conducted pursuant to the requirements of these regulations.

(c) Explanation of the compelling factors such as time or economic factors which prevent such system from achieving compliance.

(d) Other information, if any, believed by the applicant to be pertinent to the application.

(e) A proposed compliance schedule, including the date when each step toward compliance will be achieved.

- (f) Such other information as the Department may require.
- (3) Consideration of an exemption request.
- (a) The Department will act on any exemption request submitted pursuant to paragraph (2) above within 90 days of receipt of the request.
 - (b) In its consideration of whether the public water system is unable to comply due to compelling factors, the Department will consider such factors as the following:
 - (i) Construction, installation, or modification of the treatment equipment or systems.
 - (ii) The time needed to put into operation a new treatment facility to replace an existing system which is not in compliance.
 - (iii) Economic feasibility of compliance.
- (4) Disposition of an exemption request.
- (a) If the Department decides to deny the application for an exemption, it will notify the applicant of its intention to issue a denial. Such notice will include a statement of reasons for the proposed denial, and will offer the applicant an opportunity to present, within 30 days of receipt of the notice, additional information or argument to the Department. The Department will make a final determination on the request within 30 days after receiving any such additional information or argument. If no additional information or argument is submitted by the applicant, the application will be denied.
 - (b) If the Department proposes to grant an exemption request submitted pursuant to paragraph (2) above, it will notify the applicant of its decision in writing. Such notice will identify the facility covered, and will specify the termination date of the exemption. Such notice will provide that the exemption will be terminated when the system comes into compliance with the applicable regulation, and may be terminated upon a finding by the Department that the system has failed to comply with any requirements of a final schedule issued pursuant to paragraph (6) below.
 - (c) The Department will propose a schedule for:
 - (i) Compliance (including increments of progress) by the public water system with each contaminant level requirement and treatment technique requirement covered by the exemption; and,
 - (ii) Implementation by the public water system of such control measures as the Department may require for each contaminant covered by the exemption.
 - (d) The schedule will be prescribed by the Department at the time the exemption is granted, subsequent to provision of opportunity for hearing pursuant to paragraph (5) below.
- (5) Public notice and opportunity for hearing.
- (a) Before a schedule proposed by the Department pursuant to paragraph (4) above may take effect, the Department will provide notice and opportunity for public hearing on the schedule. A notice given pursuant to the preceding sentence may cover the proposal of more than one such schedule and a hearing held pursuant to such notice shall include each of the schedules covered by the notice.
 - (b) Public notice of an opportunity for hearing on an exemption schedule will be circulated in a manner designed to inform interested and potentially interested persons of the proposed schedule, and will include at least the following:
 - (i) Posting of a notice in the principal post office of each municipality or area served by the public water system, and publishing of a notice in a newspaper or newspapers of general circulation in the area served by the public water system.
 - (ii) Such notice will include a summary of the proposed schedule and shall inform interested persons that they may request a public hearing on the proposed schedule.
 - (c) Requests for hearing may be submitted by any interested person. Frivolous or insubstantial requests for hearing may be denied by the Department. Requests must be submitted to the Department within 30 days after issuance of the public notices provided for in paragraph (b) of this section. Such request shall include the following information:

(i) The name, address and telephone number of the individual, organization or other entity requesting a hearing.

(ii) A brief statement of the interest of the person making the request in the proposed schedule and of information that the requesting person intends to submit at such hearing.

(iii) The signature of the individual making the request, or, if the request is made on behalf of an organization or other entity, the signature of a responsible official of the organization or other entity.

(d) The Department will give notice of any hearing to be held pursuant to a request submitted by an interested person or on its own motion. Notice will be given and such hearing conducted in accordance with the Department's administrative procedures.

(e) The exemption and schedule will become effective 30 days after notice of opportunity for hearing is given pursuant to paragraph (a) of this section if no timely request for hearing is submitted and the Department does not determine to hold a hearing on its own motion.

(6) Final schedule.

(a) If a public hearing is held pursuant to paragraph (5) above, the Department will take into consideration information obtained during such hearing, and revise the proposed schedule as necessary and prescribe the final schedule.

(b) Such schedule must require compliance 12 months after the issuance of the exemption.

(7) Extension for date of compliance.

(a) The final date for compliance provided in any schedule in the case of any exemption may be extended by the Department for a period not to exceed 3 years after the date of the issuance of the exemption if the public water system establishes that:

(i) The system cannot meet the standard without capital improvements which cannot be completed within the period of such exemption;

(ii) In the case of a system which needs financial assistance for the necessary improvements, the system has entered into an agreement to obtain such financial assistance; or,

(iii) The system has entered into an enforceable agreement to become a part of a regional public water system; and the system is taking all practicable steps to meet the standard.

(b) In the case of a system which does not serve more than 500 service connections and which needs financial assistance for the necessary improvements, an exemption granted under paragraph (a)(i) or (ii) may be renewed for one or more additional 2-year periods if the system establishes that it is taking all practicable steps to meet the requirements of paragraph (a) of this section.

(8) Bottled water, point-of-use and point-of-entry devices.

(a) The Department may require a public water system to use bottled water, point-of-use, or point-of-entry devices as a condition for granting an exemption from the requirements of R.61-58.5.B(2), D(2)(b) and N.

(b) Public water systems that use bottled water as a condition of obtaining an exemption from the requirements of R.61-58.5.B(2), D(2)(b) and N must meet the requirements set out in R.61-58.9.F(8).

(c) Public water systems that use point-of-use or point-of-entry devices as a condition for receiving an exemption must meet the requirements of R.61-58.9.F(9).

D. Variances from the Maximum Contaminant Level for Total Trihalomethanes

(1) The following are identified as the best technology, treatment techniques or other means generally available for achieving compliance with the maximum contaminant level for total trihalomethanes (TTHM):

(a) Use of chloramines as an alternate or supplemental disinfectant or oxidant.

(b) Use of chlorine dioxide as an alternate or supplemental disinfectant or oxidant.

(c) Improved existing clarification for THM precursor reduction.

(d) Moving the point of chlorination to reduce TTHM formation and, where necessary, substituting for the use of chlorine as a pre-oxidant chloramines, chlorine dioxide or potassium permanganate.

(e) Use of powdered activated carbon for THM precursor or TTHM reduction seasonally or intermittently at dosages not to exceed 10 mg/l on an annual average basis.

(2) The Department will consider a request for a variance from the maximum contaminant level for total trihalomethanes only from a community system which has installed the best available technology or treatment method specified in paragraph (1) above unless the Department determines that such treatment method is not available and effective for TTHM control for the system. A treatment method will not be considered to be "available and effective" for an individual system if the treatment method would not be technically appropriate and technically feasible for that system or would only result in a marginal reduction in TTHM for the system. The Department's determination as to the availability and effectiveness of such treatment methods will be based upon studies by the system and other relevant information. If a system submits information intending to demonstrate that a treatment method is not available and effective for TTHM control for that system, the Department will make a finding whether this information supports a decision that such treatment method is not available and effective for that system before requiring installation and/or use of such treatment method.

(3) Pursuant to R.61.58.9(B)(4)(c) -(g), the Department will issue a schedule of compliance that may require the system being granted the variance to examine the following treatment methods to determine the probability that any of these methods will significantly reduce the level of TTHM for that system and, if such probability exists, to determine whether any of these methods are technically feasible and economically reasonable, and that the TTHM reductions obtained will be commensurate with the costs incurred with the installation and use of such treatment methods for that system:

- (a) Introduction of off-line water storage for THM precursor reduction.
- (b) Aeration for TTHM reduction, where geographically and environmentally appropriate.
- (c) Introduction of clarification where not currently practiced.
- (d) Consideration of alternative sources of raw water.
- (e) Use of ozone as an alternate or supplemental disinfectant or oxidant.

(4) If the Department determines that a treatment method identified in paragraph (3) above is technically feasible, economically reasonable and will achieve TTHM reductions commensurate with the costs incurred with the installation and/or use of such treatment method for the system, the Department will require the system to install and/or use that treatment method in connection with its compliance schedule. The Department's determination will be based upon studies by the system and other relevant information. In no event will the Department require a system to install and/or use a treatment method not described in paragraph (1) or (3) above to obtain or maintain a variance from the TTHM maximum contaminant level or in connection with any variance compliance schedule.

E. Variances from the Maximum Contaminant Level for Fluoride

(1) The following are identified as the best technology, treatment techniques or other means generally available for achieving compliance with the maximum contaminant level for fluoride:

- (a) Activated alumina absorption, centrally applied; and,
- (b) Reverse osmosis, centrally applied.

(2) The Department will consider a request for a variance from the maximum contaminant level for fluoride only from a community water system which has installed the best available technology or treatment method specified in paragraph (1) above unless the Department determines that such treatment method is not available and effective for fluoride control for the system. A treatment method will not be considered to be "available and effective" for an individual system if the treatment method would not be technically appropriate and technically feasible for that system. The Department's determination as to the availability and effectiveness of such treatment methods will be based upon studies by the system and other relevant information. If a system submits information to demonstrate that a treatment method is not available and effective for fluoride control for that system, the Department will make a finding whether this information supports a decision that such

treatment method is not available and effective for that system before requiring installation and/or use of such treatment method.

(3) Pursuant to R.61-58.9(B)(4)(c) -(g), the Department will issue a schedule of compliance that may require the system being granted the variance to examine the following treatment methods to determine the probability that any of these methods will significantly reduce the level of fluoride for that system and, if such probability exists, to determine whether any of these methods are technically feasible and economically reasonable and that the fluoride reductions obtained will be commensurate with the costs incurred with the installation and use of such treatment methods for that system:

- (a) Modification of lime softening
- (b) Alum coagulation
- (c) Electrodialysis
- (d) Anion exchange resins
- (e) Well field management
- (f) Alternate source
- (g) Regionalization

(4) If the Department determines that a treatment method identified in paragraph (3) above or other treatment method is technically feasible, economically reasonable, and will achieve fluoride reductions commensurate with the costs incurred with the installation and/or use of such treatment method for the system, the Department will require the system to install and/or use that treatment method in connection with its compliance schedule. The Department's determination will be based upon studies by the system and other relevant information.

F. Variances and Exemptions from the Maximum Contaminant Levels for Organic and Inorganic Chemicals and Exemptions from the Treatment Technique for Lead and Copper.

(1) The following are identified as the best technology, treatment techniques, or other means available for achieving compliance with the maximum contaminant levels for volatile organic chemicals as listed in R.61-58.5.N and the organic chemicals listed in R.61-58.5.D(2):

BEST AVAILABLE TECHNOLOGIES FOR ORGANIC CONTAMINANTS

<u>CAS Number</u>	<u>Contaminant</u>	<u>Granular Activated Carbon</u>	<u>Packed Tower Aeration</u>	<u>Oxidation</u>
15972-60-8	Alachlor	X		
116-06-3	Aldicarb	X		
1646-88-4	Aldicarb sulfone	X		
1646-87-3	Aldicarb sulfoxide	X		
1912-24-9	Atrazine	X		
71-43-2	Benzene	X	X	
50-32-8	Benzo(a)pyrene	X		
1563-66-2	Carbofuran	X		
56-23-5	Carbon tetrachloride	X	X	
57-74-9	Chlordane	X		
75-99-0	Dalapon	X		
94-75-7	2,4-D	X		
103-23-1	Di(2-ethylhexyl) adipate	X	X	
117-81-7	Di(2-ethylhexyl) phthalate	X		
96-12-8	Dibromochloropropane (DBCP)	X		
95-50-1	o-Dichlorobenzene	X	X	
106-46-7	para-Dichlorobenzene	X	X	
107-06-2	1,2-Dichloroethane	X	X	
75-35-4	1,1-Dichloroethylene	X	X	
156-59-2	cis-1,2-Dichloroethylene	X	X	
156-60-5	trans-1,2-Dichloroethylene	X	X	
75-09-2	Dichloromethane		X	
78-87-5	1,2-Dichloropropane	X	X	
88-85-7	Dinoseb	X		
85-00-7	Diquat	X		

CAS Number	Contaminant	Granular Activated Carbon	Packed Tower Aeration	Oxidation
145-73-3	Endothall	X		
72-20-8	Endrin	X		
100-41-4	Ethylbenzene	X	X	
106-93-4	Ethylene dibromide (EDB)	X	X	
1071-83-6	Glyphosate			X
76-44-8	Heptachlor	X		
1024-57-3	Heptachlor epoxide	X		
118-74-1	Hexachlorobenzene	X		
77-47-3	Hexachlorocyclopentadiene	X	X	
58-89-9	Lindane	X		
72-43-5	Methoxychlor	X		
108-90-7	Monochlorobenzene	X	X	
23135-22-0	Oxamyl (Vydate)	X		
87-86-5	Pentachlorophenol	X		
1918-02-1	Picloram	X		
1336-36-3	Polychlorinated biphenyls (PCB)	X		
122-34-9	Simazine	X		
100-42-5	Styrene	X	X	
1746-01-6	2,3,7,8-TCDD (Dioxin)	X		
127-18-4	Tetrachloroethylene	X	X	
108-88-3	Toluene	X	X	
8001-35-2	Toxaphene	X		
93-72-1	2,4,5-TP (Silvex)	X		
120-82-1	1,2,4-Trichlorobenzene	X	X	
71-55-6	1,1,1-Trichloroethane	X	X	
79-00-5	1,1,2-Trichloroethane	X	X	
79-01-6	Trichloroethylene	X	X	
75-01-4	Vinyl chloride		X	
1330-20-7	Xylene	X	X	

(2) The following are identified as the best technology, treatment techniques, or other means available for achieving compliance with the maximum contaminant levels for the inorganic contaminants listed in R.61-58.5(B)(2), except fluoride:

<u>CHEMICAL NAME</u>	<u>BAT(S)</u>
Antimony	2,7
Arsenic ⁴	1,2,5,6,7,9,12 ⁵
Asbestos	2,3,8
Barium	5,6,7,9
Beryllium	1,2,5,6,7
Cadmium	2,5,6,7
Chromium	2,5,6 ² ,7
Cyanide	5,7,10
Mercury	2 ¹ ,4,6 ¹ ,7 ¹
Nickel	5,6,7
Nitrate	5,7,9
Nitrite	5,7
Selenium	1,2 ³ ,6,7,9
Thallium	1,5

¹ BAT only if influent Hg concentrations < 10 µg/L.

² BAT for Chromium III only.

³ BAT for Selenium IV only.

⁴ BATs for Arsenic V. Pre-oxidation may be required to convert Arsenic III to Arsenic V

⁵ To obtain high removals, iron to arsenic ratio must be at least 20:1.

Key to BATs in Table
1 = Activated Alumina

- 2 = Coagulation/Filtration (not BAT for systems serving less than 500 service connections)
- 3 = Direct and Diatomite Filtration
- 4 = Granular Activated Carbon
- 5 = Ion Exchange
- 6 = Lime (not less than 500 service connections) BAT for systems softening
- 7 = Reverse Osmosis
- 8 = Corrosion Control
- 9 = Electrodialysis
- 10 = Chlorine
- 11 = Ultraviolet
- 12 = Oxidation/Filtration

(3) The Department identifies in the following table the affordable technology, treatment technique, or other means available to systems serving 10,000 persons or fewer for achieving compliance with the maximum contaminant level for arsenic:

SMALL SYSTEM COMPLIANCE TECHNOLOGIES (SSCT)¹ FOR ARSENIC ²

Small system compliance technology	Affordable for listed small system categories ³
Activated Alumina (centralized)	All size categories
Activated Alumina (Point-of-Use) ⁴	All size categories
Coagulation/Filtration ⁵	501–3,300, 3,301–10,000
Coagulation-assisted Microfiltration.....	501–3,300, 3,301–10,000
Electrodialysis reversal ⁶	501–3,300, 3,301–10,000
Enhanced coagulation/filtration	All size categories
Enhanced lime softening (pH > 10.5)	All size categories
Ion Exchange	All size categories
Lime Softening ⁵	501–3,300, 3,301–10,000
Oxidation/Filtration ⁷	All size categories
Reverse Osmosis (centralized) ⁶	501–3,300, 3,301–10,000
Reverse Osmosis (Point-of-Use) ⁴	All size categories

¹ Section 1412(b)(4)(E)(ii) of SDWA specifies that SSCTs must be affordable and technically feasible for small systems.

² SSCTs for Arsenic V. Pre-oxidation may be required to convert Arsenic III to Arsenic V.

³ The Act (ibid.) specifies three categories of small systems: (i) those serving 25 or more, but fewer than 501, (ii) those serving more than 500, but fewer than 3,301, and (iii) those serving more than 3,300, but fewer than 10,001.

⁴ When POU or POE devices are used for compliance, programs to ensure proper long-term operation, maintenance, and monitoring must be provided by the water system to ensure adequate performance.

⁵ Unlikely to be installed solely for arsenic removal. May require pH adjustment to optimal range if high removals are needed.

⁶ Technologies reject a large volume of water—may not be appropriate for areas where water quantity may be an issue.

⁷ To obtain high removals, iron to arsenic ratio must be at least 20:1.

(4) The Department shall require community water systems and non-transient, non-community water systems to install and/or use any treatment method identified in paragraphs 1 and 2 of the section as a condition for granting a variance except as provided in paragraph (4) of this section. If, after the system's installation of the treatment method, the system cannot meet the MCL, that system shall be eligible for a variance under the provisions of section B above.

(5) If a system can demonstrate through comprehensive engineering assessments, which may include pilot plant studies, that the treatment methods identified in paragraphs 1 and 2 of the section would only achieve a de minimis reduction in contaminants, the Department may issue a schedule of compliance that requires the system being granted the variance to examine other treatment methods as a condition of obtaining the variance.

(6) If the Department determines that a treatment method identified in paragraph (4) of this section is technically feasible, the Department may require the system to install and/or use that treatment method in connection with a compliance schedule issued under the provisions of R.61-58.9(B)(4)(c) through (g). The Department's determination shall be based upon studies by the system and other relevant information.

(7) The Department may require a public water system to use bottled water, point-of-use devices, point-of-entry devices or other means as a condition of granting a variance or an exemption from the requirements of R.61-58.5.B(2), D(2)(b) and N, to avoid an unreasonable risk to health. The Department may require a public water system to use bottled water and point-of-use devices or other means, but not point-of-entry devices, as a condition for granting an exemption from corrosion control treatment requirements for lead and copper in R.61-58.11.C and D to avoid an unreasonable risk to health. The Department may require a public water system to use point-of-entry devices as a condition for granting an exemption from the source water and lead service line replacement requirements for lead and copper under R.61-58.11.E or F to avoid an unreasonable risk to health.

(8) Public water systems that use bottled water as a condition for receiving a variance or exemption from the requirements of R.61-58.5.B(2), D(2)(b) and N, or an exemption from the requirements of R.61-58.11.C through F, must meet the requirements in either paragraph (a) or (b) of this section in addition to the requirements in paragraph (c) of this section:

(a) The public water system must develop and put in place a monitoring program approved by the Department that provides reasonable assurances that the bottled water meets all maximum contaminant levels. The public water system must monitor a representative sample of the bottled water for all contaminants regulated under R.61-58.5.B(2), D(2)(b) and N the first quarter that it supplies the bottled water to the public, and annually thereafter. Results of the monitoring program shall be provided to the Department annually.

(9) Public water systems that use point-of-use or point-of-entry devices as a condition for obtaining a variance or exemption from the maximum contaminant levels listed in R.61-58.5.B(2), D(2)(b) and N must meet the following requirements:

(a) It is the responsibility of the public water system to operate and maintain the point-of-use and/or point-of-entry treatment system.

(b) The public water system must develop a monitoring plan and obtain Department approval for the plan before point-of-use or point-of-entry devices are installed for compliance. This monitoring plan must provide health protection equivalent to a monitoring plan for central water treatment.

(c) Effective technology must be properly applied under a plan approved by the Department and the microbiological safety of the water must be maintained at all times.

(d) The public water system must provide adequate certification of performance, field testing, and, if not included in the certification process, a rigorous engineering design review of the point-of-use and/or point-of-entry devices.

(e) The design and application of the point-of-use and/or point-of-entry devices must consider the tendency for an increase in heterotrophic bacteria concentrations in water treated with activated carbon. It may be necessary to use frequent backwashing, post-contactors disinfection, and Heterotrophic Plate Count monitoring to ensure that the microbiological safety of the water is not compromised.

(f) All consumers shall be protected. Every building connected to the system must have a point-of-use or point-of-entry device installed, maintained, and adequately monitored. The Department must be assured by the public water system that every building is subject to treatment and monitoring, and that the rights and responsibilities of the public water system customer convey with title upon sale of the property.

(g) In requiring the use of a point-of-entry device as a condition for granting an exemption from the treatment requirements for lead and copper under R.61-58.11.E or F, the Department must be assured that use of the device will not cause increased corrosion of lead and copper bearing materials located between the device and the tap that could increase contaminant levels at the tap.

G. Variances and Exemptions from the Maximum Contaminant Level for Total Coliforms.

(1) The following are identified as the best technology, treatment techniques, or other means available for achieving compliance with the MCL for total coliforms:

- (a) Protection of wells from contamination by coliforms by appropriate placement and construction;
- (b) Maintenance of a disinfectant residual throughout the distribution system;
- (c) Proper maintenance of the distribution system including appropriate pipe replacement and repair procedures, main flushing programs, proper operation and maintenance of storage tanks and reservoirs, and continual maintenance of positive water pressure in all parts of the distribution system;
- (d) Filtration and/or disinfection of surface water, as described in R.61-58.10, or disinfection of ground water using strong oxidants such as chlorine, chlorine dioxide, or ozone; or
- (e) The development and implementation of an EPA-approved State Wellhead Protection Program under section 1428 of the Federal Safe Drinking Water Act.

(2) No variances or exemptions from the maximum contaminant levels in R.61-58.5.F or the treatment technique requirements of R.61-58.10 are permitted. In accordance with EPA rules, the Department has stayed the effective date of this section relating to the total coliform MCL of R.61-58.5.F(1) for systems that demonstrate to the Department that the violation of the total coliform MCL is due to persistent growth of total coliforms in the distribution system rather than fecal or pathogenic contamination, a treatment lapse or deficiency, or a problem in the operation or maintenance of the distribution system. This is stayed until March 31, 2016, at which time the total coliform MCL is no longer effective.

H. Variances and Exemptions from the Filtration and Disinfection Requirements.

- (1) No variances from the filtration and disinfection requirements are permitted.
- (2) No exemptions from the disinfection requirements of R.61-58.10(D)(1)(c) and (2)(b) are permitted.

I. Variances and Exemptions from the Maximum Contaminant Levels for Radionuclides.

(1) The following are identified as the best available technology, treatment techniques, or other means available for achieving compliance with the maximum contaminant levels for radionuclides listed in R.61-58.5.H(2), (3), (4), and (5), for the purposes of issuing variances and exemptions, as shown in Table A to this paragraph.

TABLE A: BAT FOR RADIONUCLIDES LISTED IN R.61-58.5.H

Contaminant	BAT
Combined radium-226 and radium-228	Ion exchange, reverse osmosis, lime softening.
Uranium	Ion exchange, reverse osmosis, lime softening, coagulation/filtration.
Gross alpha particle activity (excluding radon and uranium)	Reverse osmosis.
Beta particle and photon radioactivity	Ion exchange, reverse osmosis.

(2) In addition, the following are identified as the best available technology, treatment techniques, or other means available for achieving compliance with the maximum contaminant levels for the radionuclides listed in R.61-58.5.H(2), (3), (4), and (5), for the purposes of issuing variances and exemptions to small drinking water systems, defined here as those serving 10,000 persons or fewer, as shown in Table C to this paragraph.

TABLE B: LIST OF SMALL SYSTEMS COMPLIANCE TECHNOLOGIES FOR RADIONUCLIDES AND LIMITATIONS TO USE

Unit technologies	Limitations (see footnotes)	Operator skill level required ¹	Raw water quality range & considerations ¹

Unit technologies	Limitations (see footnotes)	Operator skill level required ¹	Raw water quality range & considerations ¹
1. Ion exchange (IE)	(a)	Intermediate	All ground waters.
2. Point of use (POU ²) IE	(b)	Basic	All ground waters.
3. Reverse osmosis (RO)	(c)	Advanced	Surface waters usually require pre-filtration.
4. POU ² RO	(b)	Basic	Surface waters usually require pre-filtration.
5. Lime softening	(d)	Advanced	All waters.
6. Green sand filtration	(e)	Basic	
7. Co-precipitation with barium sulfate	(f)	Intermediate to Advanced	Ground waters with suitable water quality.
8. Electrodialysis/electrodialysis reversal		Basic to Intermediate	All ground waters.
9. Pre-formed hydrous manganese oxide filtration	(g)	Intermediate	All ground waters.
10. Activated alumina	(a), (h)	Advanced	All ground waters; competing anion concentrations may affect regeneration frequency
11. Enhanced coagulation/filtration	(i)	Advanced.	Can treat a wide range of water qualities.

¹ National Research Council (NRC). Safe Water from Every Tap: Improving Water Service to Small Communities. National Academy Press. Washington, D.C. 1997.

² A POU, or “point-of-use” technology is a treatment device installed at a single tap used for the purpose of reducing contaminants in drinking water at that one tap. POU devices are typically installed at the kitchen tap. See the April 21, 2000 NODA for more details.

Limitations Footnotes: Technologies for Radionuclides:

^a The regeneration solution contains high concentrations of the contaminant ions. Disposal options should be carefully considered before choosing this technology.

^b When POU devices are used for compliance, programs for long-term operation, maintenance, and monitoring must be provided by water utility to ensure proper performance.

^c Reject water disposal options should be carefully considered before choosing this technology. See other RO limitations described in the SWTR compliance technologies table.

^d The combination of variable source water quality and the complexity of the water chemistry involved may make this technology too complex for small surface water systems.

^e Removal efficiencies can vary depending on water quality.

^f This technology may be very limited in application to small systems. Since the process requires static mixing, detention basins, and filtration, it is most applicable to systems with sufficiently high sulfate levels that already have a suitable filtration treatment train in place.

^g This technology is most applicable to small systems that already have filtration in place.

^h Handling of chemicals required during regeneration and pH adjustment may be too difficult for small systems without an adequately trained operator.

ⁱ Assumes modification to a coagulation/filtration process already in place.

TABLE C: BAT FOR SMALL COMMUNITY WATER SYSTEMS FOR THE RADIONUCLIDES LISTED IN R.61-58.5.H

Unit technologies	Limitations (see footnotes)	Operator skill level required ¹	Raw water quality range & considerations ¹
	Compliance technologies ¹ for system size categories (population served)		
	25–500	501–3,300	3,300–10,000
Combined radium-226 and radium-228	1, 2, 3, 4, 5, 6, 7, 8, 9	1, 2, 3, 4, 5, 6, 7, 8, 9	1, 2, 3, 4, 5, 6, 7, 8, 9
Gross alpha particle activity	3, 4	3, 4	3, 4
Beta particle activity and photon activity	1, 2, 3, 4	1, 2, 3, 4	1, 2, 3, 4
Uranium	1, 2, 4, 10, 11	1, 2, 3, 4, 5, 10, 11	1, 2, 3, 4, 5, 10, 11

¹ Note: Numbers correspond to those technologies found listed in the Table B to this paragraph.

(3) The Department shall require community water systems to install and/or use any treatment technology identified in Table A to this section, or in the case of small water systems (those serving 10,000 persons or fewer), Table B and Table C of this section, as a condition for granting a variance except as provided in paragraph (4) of this section. If, after the system's installation of the treatment technology, the system cannot meet the MCL, that system shall be eligible for a variance under the provisions of this section.

(4) If a community water system can demonstrate through comprehensive engineering assessments, which may include pilot plant studies, that the treatment technologies identified in this section would only achieve a de minimus reduction in the contaminant level, the Department may issue a schedule of compliance that requires the system being granted the variance to examine other treatment technologies as a condition of obtaining the variance.

(5) If the Department determines that a treatment technology identified under paragraph (4) of this section is technically feasible, the Administrator or the Department may require the system to install and/or use that treatment technology in connection with a compliance schedule issued under the provisions of this section. The Department's determination shall be based upon studies by the system and other relevant information.

(6) The Department may require a community water system to use bottled water, point-of-use devices, point-of-entry devices or other means as a condition of granting a variance or an exemption from the requirements of R.61-58.5.H of this regulation, to avoid an unreasonable risk to health.

(7) Community water systems that use bottled water as a condition for receiving a variance or an exemption from the requirements of R.61-58.5.H of this regulation must meet the requirements specified in Section F(7)(a) through (c) above.

(8) Community water systems that use point-of-use or point-of-entry devices as a condition for obtaining a variance or an exemption from the radionuclides SPDWRs must meet the conditions in Section F(8) above.

HISTORY: Amended by State Register Volume 17, Issue No. 8, eff August 27, 1993; State Register Volume 17, Issue No. 12, eff December 24, 1993; State Register Volume 18, Issue No. 11, eff November 25, 1994; State Register Volume 19, Issue No. 7, eff July 28, 1995; State Register Volume 25, Issue No. 9, eff September 28, 2001; State Register Volume 26, Issue No. 12, eff December 27, 2002; State Register Volume 28, Issue No. 1, eff January 23, 2004; State Register Volume 38, Issue No. 9, Doc. No. 4469, eff September 26, 2014.

61–58.10. Filtration and Disinfection.

Table of Contents

- A. Applicability
- B. General Requirements
- C. Criteria for Avoiding Filtration

- D. Disinfection
 - E. Filtration
 - F. Analytical and Monitoring Requirements
 - G. Reporting and Recordkeeping Requirements
 - H. Enhanced Filtration and Disinfection—Systems Serving 10,000 or More People
 - I. Enhanced Filtration and Disinfection—Systems Serving Fewer Than 10,000 People
 - J. Recycle Provisions.
-

A. Applicability.

(1) This regulation establishes criteria and requirements for the filtration and disinfection of drinking water served to the public. This regulation shall apply to each community and non-community water system, unless the water system meets all of the following conditions:

- (a) Consists only of distribution and storage facilities (and does not have any collection and treatment facilities);
- (b) Obtains all of its water from, but is not owned or operated by, a public water system to which such regulations apply;
- (c) Does not sell water to any person; and
- (d) Is not a carrier which conveys passengers in interstate commerce.

(2) The requirements of R.61–58.10.B through R61–58.10.G apply to all public water systems supplied by a surface water source and all public water systems supplied by a ground water source under the direct influence of surface water. In addition to these requirements, all public water systems supplied by a surface water source or a ground water source under the direct influence of surface water which serve at least 10,000 people must also comply with R.61–58.10.H and for all public water systems supplied by a surface water source or a groundwater source under the direct influence of surface water which serve fewer than 10,000 people must also comply with R.61–58.10.I.

B. General Requirements.

(1) The requirements of this regulation constitute national primary drinking water regulations. These regulations establish criteria under which filtration is required as a treatment technique for public water systems supplied by a surface water source and public water systems supplied by a ground water source under the direct influence of surface water. In addition, these regulations establish treatment technique requirements in lieu of maximum contaminant levels for the following contaminants: *Giardia lamblia*, viruses, heterotrophic plate count bacteria, *Legionella*, and turbidity. Each public water system with a surface water source or a ground water source under the direct influence of surface water shall provide treatment of that source water that complies with these treatment technique requirements. The treatment technique requirements consist of installing and properly operating water treatment processes which reliably achieve:

- (a) At least 99.9 percent (3-log) removal and/or inactivation of *Giardia lamblia* cysts between a point where the raw water is not subject to recontamination by surface water runoff and a point downstream before or at the first customer; and
- (b) At least 99.99 percent (4-log) removal and/or inactivation of viruses between a point where the raw water is not subject to recontamination by surface water runoff and a point downstream before or at the first customer.

(2) A public water system using a surface water source or a ground water source under the direct influence of surface water is considered to be in compliance with the requirements of paragraph (1) of this section if:

- (a) It meets the requirements for avoiding filtration in R.61-58.10(C) and the disinfection requirements in R.61-58.10(D)(1); or,
- (b) It meets the filtration requirements in R.61-58.10(E) and the disinfection requirements in R.61-58.10(D)(2).

(3) Each public water system using a surface water source or a ground water source under the direct influence of surface water shall be operated by qualified personnel who meet the requirements specified by the Department.

C. Criteria for Avoiding Filtration.

A public water system that uses a surface water source shall meet all of the conditions of paragraphs (1) and (2) of this section, and is subject to paragraph (3) of this section, beginning December 30, 1991, unless the Department has determined, in writing, that filtration is required. A public water system that uses a ground water source under the direct influence of surface water shall meet all of the conditions of paragraphs (1) and (2) of this section and is subject to paragraph (3) of this section, beginning 18 months after the Department determines that it is under the direct influence of surface water, or December 30, 1991, whichever is later, unless the Department has determined, in writing, that filtration is required. If the Department determines, in writing, before December 30, 1991, that filtration is required, the system shall have installed filtration and meet the criteria for filtered systems specified in R.61-58.10(D)(2) and R.61-58.10(E) by June 29, 1993. Within 18 months of the failure of a system using surface water or a ground water source under the direct influence of surface water to meet any one of the requirements of paragraphs (1) and (2) of this section or after June 29, 1993, whichever is later, the system shall have installed filtration and meet the criteria for filtered systems specified in R.61-58.10(D)(2) and R.61-58.10(E).

(1) Source water quality conditions.

(a) The fecal coliform concentration must be equal to or less than $20/100$ ml, or the total coliform concentration must be equal to or less than $100/100$ ml [measured as specified in R.61-58.10(F)(1)(a) and (b) and (2)(a)], in representative samples of the source water immediately prior to the first or only point of disinfectant application in at least 90 percent of the measurements made for the 6 previous months that the system served water to the public on an ongoing basis. If a system measures both fecal and total coliforms, the fecal coliform criterion, but not the total coliform criterion, in this paragraph must be met.

(b) The turbidity level cannot exceed 5 NTU [measured as specified in R.61-58.10(F)(1)(d) and (2)(b)] in representative samples of the source water immediately prior to the first or only point of disinfectant application unless:

(i) The Department determines that any such event was caused by circumstances that were unusual and unpredictable; and

(ii) As a result of any such event, there have not been more than two events in the past 12 months the system served water to the public, or more than five events in the past 120 months the system served water to the public, in which the turbidity level exceeded 5 NTU. An "event" is a series of consecutive days during which at least one turbidity measurement each day exceeds 5 NTU.

(2) Site-specific conditions.

(a)(i) The public water system shall meet the requirements of R.61-58.10(D)(1)(a) at least 11 of the 12 previous months that the system served water to the public, on an ongoing basis, unless the system fails to meet the requirements during 2 of the 12 previous months that the system served water to the public, and the Department determines that at least one of these failures was caused by circumstances that were unusual and unpredictable.

(ii) The public water system shall meet the requirements of R.61-58.10(D)(1)(b) at all times the system serves water to the public.

(iii) The public water system shall meet the requirements of R.61-58.10(D)(1)(c) at all times the system serves water to the public unless the Department determines that any such failure was caused by circumstances that were unusual and unpredictable.

(iv) The public water system shall meet the requirements of R.61-58.10(D)(1)(d) on an ongoing basis unless the Department determines that failure to meet these requirements was not caused by a deficiency in treatment of the source water.

(b) The public water system shall maintain a watershed control program which minimizes the potential for contamination by *Giardia lamblia* cysts and viruses in the source water. The Department shall determine whether the watershed control program is adequate to meet this goal.

The adequacy of a program to limit potential contamination by *Giardia lamblia* cysts and viruses shall be based on: the comprehensiveness of the watershed review; the effectiveness of the system's program to monitor and control detrimental activities occurring in the watershed; and the extent to which the water system has maximized land ownership and/or controlled land use within the watershed. At a minimum, the watershed control program shall;

- (i) Characterize the watershed hydrology and land ownership;
- (ii) Identify watershed characteristics and activities which may have an adverse effect on source water quality; and
- (iii) Monitor the occurrence of activities which may have an adverse effect on source water quality.

The public water system shall demonstrate through ownership and/or written agreements with landowners within the watershed that it can control all human activities which may have an adverse impact on the microbiological quality of the source water. The public water system shall submit an annual report to the Department that identifies any special concerns about the watershed and how they are being handled; describes activities in the watershed that affect water quality; and projects what adverse activities are expected to occur in the future and describes how the public water system expects to address them. For systems using a ground water source under the direct influence of surface water, an approved wellhead protection program developed under section 1428 of the Federal Safe Drinking Water Act may be used, if the Department deems it appropriate, to meet these requirements.

(c) The public water system shall be subject to an annual on-site inspection to assess the watershed control program and disinfection treatment process. Either the Department or a party approved by the Department shall conduct the on-site inspection. The inspection shall be conducted by competent individuals such as sanitary and civil engineers, sanitarians, or technicians who have experience and knowledge about the operation and maintenance of a public water system, and who have a sound understanding of public health principles and waterborne diseases. A report of the on-site inspection summarizing all findings shall be prepared every year. The on-site inspection shall indicate to the Department's satisfaction that the watershed control program and disinfection treatment process are adequately designed and maintained. The on-site inspection shall include:

- (i) A review of the effectiveness of the watershed control program;
- (ii) A review of the physical condition of the source intake and how well it is protected;
- (iii) A review of the system's equipment maintenance program to ensure there is low probability for failure of the disinfection process;
- (iv) An inspection of the disinfection equipment for physical deterioration;
- (v) A review of operating procedures;
- (vi) A review of data records to ensure that all required tests are being conducted and recorded and disinfection is effectively practiced; and
- (vii) Identification of any improvements which are needed in the equipment, system maintenance and operation, or data collection.

(d) The public water system shall not have been identified as a source of a waterborne disease outbreak, or if it has been so identified, the system shall have been modified sufficiently to prevent another such occurrence, as determined by the Department.

(e) The public water system shall comply with the maximum contaminant level (MCL) for total coliforms in R.61-58.5.F(1) and (2) and the MCL for *E. coli* in R.61-58.5.F(3) at least 11 months of the 12 previous months that the system served water to the public, on an ongoing basis, unless the Department determines that failure to meet this requirement was not caused by a deficiency in treatment of the source water.

(f) The public water system must comply with the requirements for trihalomethanes in R.61-58.13.

(3) Treatment technique violations.

- (a) A system is in violation of a treatment technique requirement if:

- (i) it fails to meet any one of the criteria in paragraphs (1) and (2) of this section and/or the Department has determined, in writing, that filtration is required; and
 - (ii) it fails to install filtration by the date specified in the introductory paragraph of this section.
- (b) A system that has not installed filtration is in violation of a treatment technique requirement if:
- (i) The turbidity level [measured as specified in R.61-58.10(F)(1)(d) and (2)(b)] in a representative sample of the source water immediately prior to the first or only point of disinfection application exceeds 5 NTU; or
 - (ii) The system is identified as a source of a waterborne disease outbreak.

D. Disinfection.

A public water system that uses a surface water source and does not provide filtration treatment shall provide the disinfection treatment specified in paragraph (1) of this section beginning December 30, 1991, unless the Department determines, in writing, that filtration is required. A public water system that uses a ground water source under the direct influence of surface water and does not provide filtration treatment shall provide disinfection treatment specified in paragraph (1) of this section beginning December 30, 1991, or 18 months after the Department determines that the ground water source is under the influence of surface water, whichever is later, unless the Department has determined, in writing, that filtration is required. If the Department has determined that filtration is required, the system shall comply with any interim disinfection requirements the Department deems necessary before filtration is installed. A system that uses a surface water source that provides filtration treatment shall provide the disinfection treatment specified in paragraph (2) of this section beginning June 29, 1993, or beginning when filtration is installed, whichever is later. A system that uses a ground water source under the direct influence of surface water and provides filtration treatment shall provide disinfection treatment as specified in paragraph (2) of this section by June 29, 1993, or beginning when filtration is installed, whichever is later. Failure to meet any requirement of this section after the applicable date specified in this introductory paragraph is a treatment technique violation.

(1) Disinfection requirements for public water systems that do not provide filtration.

Each public water system that does not provide filtration treatment shall provide disinfection treatment as follows:

- (a) The disinfection treatment shall be sufficient to ensure at least 99.9 percent (3-log) inactivation of *Giardia lamblia* cysts and 99.99 percent (4-log) inactivation of viruses, every day the system serves water to the public, except any one day each month. Each day a system serves water to the public, the public water system shall calculate the CT value(s) from the system's treatment parameters, using the procedure specified in R.61-58.10(F)(2)(c), and determine whether this value(s) is sufficient to achieve the specified inactivation rates for *Giardia lamblia* cysts and viruses. If a system uses a disinfectant other than chlorine, the system may demonstrate to the Department, through the use of a Department-approved protocol for on-site disinfection challenge studies or other information satisfactory to the Department, that CT_{99,9} values other than those specified in Tables 2.1 and 3.1 in R.61-58.10(F)(2)(c) or other operational parameters are adequate to demonstrate that the system is achieving minimum inactivation rates required by paragraph (1)(a) of this section.
- (b) The disinfection system shall have either:
 - (i) redundant components, including an auxiliary power supply with automatic start-up and alarm to ensure that disinfectant application is maintained continuously while water is being delivered to the distribution system, or
 - (ii) automatic shut-off of delivery of water to the distribution system whenever there is less than 0.2 mg/l of residual disinfectant concentration in the water. If the Department determines that automatic shut-off would cause unreasonable risk to health or interfere with fire protection, the system shall comply with paragraph (1)(b)(i) of this section.

(c) The residual disinfectant concentration in the water entering the distribution system, measured as specified in R.61-58.10(F)(1)(e) and (2)(e), cannot be less than 0.2 mg/l for more than 4 hours.

(d)(i) The residual disinfectant concentration in the distribution system, measured as total chlorine, combined chlorine, or chlorine dioxide, as specified in R.61-58.10(F)(1)(e) and (2)(f), cannot be undetectable in more than 5 percent of the samples each month, for any two consecutive months that the system serves water to the public. Water in the distribution system with a heterotrophic bacteria concentration less than or equal to 500/ml, measured as heterotrophic plate count (HPC) as specified in R.61-58.10(F)(1)(c), is deemed to have a detectable disinfectant residual for purposes of determining compliance with this requirement. Thus, the value "V" in the following formula cannot exceed 5 percent in one month, for any two consecutive months.

$$V = \frac{c + d + e}{a + b} \times 100$$

where:

- a = number of instances where the residual disinfectant concentration is measured;
- b = number of instances where the residual disinfectant concentration is not measured but heterotrophic bacteria plate count (HPC) is measured;
- c = number of instances where the residual disinfectant concentration is measured but not detected and no HPC is measured;
- d = number of instances where the residual disinfectant concentration is measured but not detected and where the HPC is > 500/ml; and
- e = number of instances where the residual disinfectant concentration is not measured and HPC is > 500/ml.

(ii) If the Department determines, based on site-specific considerations, that a system has no means for having a sample transported and analyzed for HPC by a certified laboratory under the requisite time and temperature conditions specified by R.61-58.10(F)(1)(c) and that the system is providing adequate disinfection in the distribution system, the requirements of paragraph (1)(d)(i) of this section do not apply to that system.

(2) Disinfection requirements for public water systems which provide filtration.

Each public water system that provides filtration treatment shall provide disinfection treatment as follows:

(a) The disinfection treatment shall be sufficient to ensure that the total treatment processes of that system achieve at least 99.9 percent (3-log) inactivation and/or removal of *Giardia lamblia* cysts and at least 99.99 percent (4-log) inactivation and/or removal of viruses, as determined by the Department.

(b) The residual disinfectant concentration in the water entering the distribution system, measured as specified in R.61-58.10(F)(1)(e) and (3)(b), cannot be less than 0.2 mg/l for more than 4 hours.

(c)(i) The residual disinfectant concentration in the distribution system, measured as total chlorine, combined chlorine, or chlorine dioxide, as specified in R.61-58.10(F)(1)(e) and (3)(c), cannot be undetectable in more than 5 percent of the samples each month, for any two consecutive months that the system serves water to the public. Water in the distribution system with a heterotrophic bacteria concentration less than or equal to 500/ml, measured as heterotrophic plate count (HPC) as specified in R.61-58.10(F)(1)(c), is deemed to have a detectable disinfectant residual for purposes of determining compliance with this requirement. Thus, the value "V" in the following formula cannot exceed 5 percent in one month, for any two consecutive months.

$$V = \frac{c + d + e}{a + b} \times 100$$

where:

- a = number of instances where the residual disinfectant concentration is measured;
- b = number of instances where the residual disinfectant concentration is not measured but heterotrophic bacteria plate count (HPC) is measured;

- c = number of instances where the residual disinfectant concentration is measured but not detected and no HPC is measured;
- d = number of instances where no residual disinfectant concentration is detected and where the HPC is > 500/ml; and
- e = number of instances where the residual disinfectant concentration is not measured and HPC is > 500/ml.

(ii) If the Department determines, based on site-specific considerations, that a system has no means for having a sample transported and analyzed for HPC by a certified laboratory under the requisite time and temperature conditions specified in R.61-58.10(F)(1)(c) and that the system is providing adequate disinfection in the distribution system, the requirements of paragraph (2)(c)(i) of this section do not apply.

E. Filtration.

A public water system that uses a surface water source or a ground water source under the direct influence of surface water, and does not meet all of the criteria in R.61-58.10(C)(1) and (2) for avoiding filtration, shall provide treatment consisting of both disinfection, as specified in R.61-58.10(D)(2), and filtration treatment which complies with the requirements of paragraphs (1), (2), (3), or (4) of this section by June 29, 1993, or within 18 months of the failure to meet any one of the criteria for avoiding filtration in R.61-58.10(C)(1) and (2), whichever is later. Failure to meet any requirement of this section after the date specified in this introductory paragraph is a treatment technique violation.

(1) Conventional filtration treatment or direct filtration.

(a) For systems using conventional filtration or direct filtration, the turbidity level of representative samples of a system's filtered water must be less than or equal to 0.5 NTU in at least 95 percent of the measurements taken each month, measured as specified in R.61-58.10(F)(1)(d) and (3)(a), except that if the Department determines that the system is capable of achieving at least 99.9 percent removal and/or inactivation of *Giardia lamblia* cysts at some turbidity level higher than 0.5 NTU in at least 95 percent of the measurements taken each month, the Department may substitute this higher turbidity limit for that system. However, in no case may the Department approve a turbidity limit that allows more than 1 NTU in more than 5 percent of the samples taken each month, measured as specified in R.61-58.10(F)(1)(d) and (3)(a).

(b) The turbidity level of representative samples of a system's filtered water must at no time exceed 5 NTU, measured as specified in R.61-58.10(F)(1)(d) and (3)(a).

(c) Beginning January 1, 2002, systems serving at least 10,000 people must meet the requirements of Section H(4)(a) below.

(d) Beginning January 1, 2005, systems serving fewer than 10,000 people must meet the turbidity requirements in Section I(6) below.

(2) Slow sand filtration.

(a) For systems using slow sand filtration, the turbidity level of representative samples of a system's filtered water must be less than or equal to 1 NTU in at least 95 percent of the measurements taken each month, measured as specified in R.61-58.10(F)(1)(d) and (3)(a), except that if the Department determines there is no significant interference with disinfection at a higher turbidity level, the Department may substitute this higher turbidity limit for that system.

(b) The turbidity level of representative samples of a system's filtered water must at no time exceed 5 NTU, measured as specified in R.61-58.10(F)(1)(d) and (3)(a).

(3) Diatomaceous earth filtration.

(a) For systems using diatomaceous earth filtration, the turbidity level of representative samples of a system's filtered water must be less than or equal to 1 NTU in at least 95 percent of the measurements taken each month, measured as specified in R.61-58.10(F)(1)(d) and (3)(a).

(b) The turbidity level of representative samples of a system's filtered water must at no time exceed 5 NTU, measured as specified in R.61-58.10(F)(1)(d) and (3)(a).

(4) Other filtration technologies.

A public water system may use a filtration technology not listed in paragraphs (1) through (3) of this section if it demonstrates to the Department, using pilot plant studies or other means, that the alternative filtration technology, in combination with disinfection treatment that meets the requirements of Section D(2), above, consistently achieves 99.9 percent removal and/or inactivation of *Giardia lamblia* cysts and 99.99 percent removal and/or inactivation of viruses. For a system that makes this demonstration, the requirements of paragraph (2) of this section apply. Beginning January 1, 2002, systems serving at least 10,000 people must meet the requirements for other filtration technologies in R.61-58.10.H(4)(b). Beginning January 1, 2005, systems serving fewer than 10,000 people must meet the requirements for other filtration technologies in Section I(6) below.

F. Analytical and Monitoring Requirements.

(1) Analytical requirements.

Only the analytical method(s) specified in this paragraph, or otherwise approved by EPA, may be used to demonstrate compliance with the requirements of R.61-58.10.C, R.61-58.10.D, and R.61-58.10.E. Measurements for pH, temperature, turbidity and residual disinfectant concentrations shall be conducted by a party approved by the Department. Measurements for total coliforms, fecal coliforms, and HPC shall be conducted by a laboratory certified by the Department or EPA to do such analysis. Until laboratory certification criteria are developed for the analysis of HPC and fecal coliforms, any laboratory certified for total coliform analysis by EPA is deemed certified for HPC and fecal coliform analysis. All procedures shall be performed in accordance with EPA-approved methods outlined in 40 CFR 141 (11-8-06 edition).

(a) Fecal coliform concentration—Method 908C (Fecal Coliform MPN Procedures), Method 908D (Estimation of Bacterial Density), or Method 909C (Fecal Coliform Membrane Filter Procedure), as set forth in Standard Methods for the Examination of Water and Wastewater, 1985, 16th edition.

(b) Total coliform concentration—Method 908A (Standard Total Coliform Multiple-Tube (MPN) Tests), Method 908B (Application of Tests to Routine Examinations), Method 908D (Estimation of Bacterial Density), Method 909A (Standard Total Coliform Membrane Filter Procedure), or Method 909B (Delayed-Incubation Total Coliform Procedure), as set forth in Standard Methods for the Examination of Water and Wastewater, 1985, 16th edition; Minimal Medium ONPG-MUG Test, as set forth in the article “National Field Evaluation of a Defined Substrate Method for the Simultaneous Enumeration of Total Coliforms and *Escherichia coli* from Drinking Water: Comparison with the Standard Multiple Tube Fermentation Method” (Edberg et al.), Applied and Environmental Microbiology, Volume 54, June 1988 (as amended under Erratum, Volume 54, December 1988). (Note: The Minimal Medium ONPG-MUG Test is sometimes referred to as the Autoanalysis Colilert System.) Systems may use a five-tube test or a ten-tube test.

(c) Heterotrophic Plate Count—Method 907A (Pour Plate Method), as set forth in Standard Methods for the Examination of Water and Wastewater, 1985, 16th edition.

(d) Turbidity—Method 214A (Nephelometric Method-Nephelometric Turbidity Units), as set forth in Standard Methods for the Examination of Water and Wastewater, 1985, 16th edition.

(e) Residual disinfectant concentration—Residual disinfectant concentrations for free chlorine and combined chlorine (chloramines) shall be measured by Method 408C (Amperometric Titration Method), Method 408D (DPD Ferrous Titrimetric Method), Method 408E (DPD Colorimetric Method), or Method 408F (Leuco Crystal Violet Method), as set forth in Standard Methods for the Examination of Water and Wastewater, 1985, 16th edition. Residual disinfectant concentrations for free chlorine and combined chlorine may also be measured by using DPD colorimetric test kits if approved by the Department. Residual disinfectant concentrations for ozone must be measured by the Indigo Method as set forth in Bader, H., Hoigne, J., “Determination of Ozone in Water by the Indigo Method; A Submitted Standard Method”; Ozone Science and Engineering, Vol. 4, Pergamon Press Ltd., 1982, or automated methods which are calibrated in reference to the results obtained by the Indigo Method on a regular basis, if approved by the Department.

Residual disinfectant concentrations for chlorine dioxide shall be measured by Method 410B (Amperometric Method) or Method 410C (DPD Method), as set forth in Standard Methods for the Examination of Water and Wastewater, 1985, 16th edition.

(f) Temperature—Method 212 (Temperature), as set forth in Standard Methods for the Examination of Water and Wastewater, 1985, 16th edition.

(g) pH—Method 423 (pH Value), as set forth in Standard Methods for the Examination of Water and Wastewater, 1985, 16th edition.

(2) Monitoring requirements for systems that do not provide filtration.

A public water system that uses a surface water source and does not provide filtration treatment shall begin monitoring, as specified in this paragraph, beginning December 31, 1990, unless the Department has determined in writing that filtration is required, in which case the Department may specify alternative monitoring requirements, as appropriate, until filtration is in place. A public water system that uses a ground water source under the direct influence of surface water and does not provide filtration treatment shall begin monitoring as specified in this paragraph beginning December 31, 1990, or 6 months after the Department determines that the ground water source is under the direct influence of surface water, whichever is later, unless the Department has determined in writing that filtration is required, in which case the Department may specify alternative monitoring requirements, as appropriate, until filtration is in place.

(a) Fecal coliform or total coliform density measurements as required by R.61-58.10(C)(1)(a) shall be performed on representative source water samples immediately prior to the first or only point of disinfectant application. The system shall sample for fecal or total coliforms at the following minimum frequency each week the system serves water to the public:

System size (persons served)	Samples/week ¹
≤500	1
501 to 3,300	2
3,301 to 10,000	3
10,001 to 25,000	4
>25,000	5

¹ Must be taken on separate days.

Also, one fecal or total coliform density measurement shall be made every day the system serves water to the public and the turbidity of the source water exceeds 1 NTU (these samples count towards the weekly coliform sampling requirements) unless the Department determines that the system, for logistical reasons outside the system’s control, cannot have the sample analyzed within 30 hours of collection.

(b) Turbidity measurements as required by R.61-58.10 (C)(1)(b) shall be performed on representative grab samples of source water immediately prior to the first or only point of disinfectant application every four hours (or more frequently) that the system serves water to the public. A public water system may substitute continuous turbidity monitoring for grab sample monitoring if it validates the continuous measurement for accuracy on a regular basis using a protocol approved by the Department.

(c) The total inactivation ratio for each day that the system is in operation shall be determined based on the CT_{99,9} values in Table 1.1-1.6, 2.1 and 3.1 of this section, as appropriate. The parameters necessary to determine the total inactivation ratio shall be monitored as follows:

(i) The temperature of the disinfected water shall be measured at least once per day at each residual disinfectant concentration sampling point.

(ii) If the system uses chlorine, the pH of the disinfected water shall be measured at least once per day at each chlorine residual disinfectant concentration sampling point.

(iii) The disinfectant contact time(s) (“T”) shall be determined for each day during peak hourly flow.

(iv) The residual disinfectant concentration(s) (“C”) of the water before or at the first customer shall be measured each day during peak hourly flow.

(v) If a system uses a disinfectant other than chlorine, the system may demonstrate to the Department, through the use of a Department-approved protocol for on-site disinfection challenge studies or other information satisfactory to the Department, that CT_{99,9} values other

than those specified in Tables 2.1 and 3.1 in this section or other operational parameters are adequate to demonstrate that the system is achieving the minimum inactivation rates required by R.61-58.10(D)(1)(a).

TABLE 1.1—CT VALUES (CT_{99.9}) FOR 99.9 PERCENT INACTIVATION OF GIARDIA LAMBLIA CYSTS BY FREE CHLORINE AT 0.5 °C OR LOWER

Free Residual (mg/l)	pH						
	≤6.0	6.5	7.0	7.5	8.0	8.5	≤9.0
≤0.4	137	163	195	237	277	329	390
0.6	141	168	200	239	286	342	407
0.8	145	172	205	246	295	354	422
1.0	148	176	210	253	304	365	437
1.2	152	180	215	259	313	376	451
1.4	155	184	221	266	321	387	464
1.6	157	189	226	273	329	397	477
1.8	162	193	231	279	338	407	489
2.0	165	197	236	286	346	417	500
2.2	169	201	242	297	353	426	511
2.4	172	205	247	298	361	435	522
2.6	175	209	252	304	368	444	533
2.8	178	213	257	310	375	452	543
3.0	181	217	261	316	382	460	552

¹ These CT values achieve greater than a 99.99 percent inactivation of viruses. CT values between the indicated pH values may be determined by linear interpolation. CT values between the indicated temperatures of different tables may be determined by linear interpolation. If no interpolation is used, use the CT_{99.9} value at the lower temperature, and at the higher pH.

TABLE 1.2—CT VALUES (CT_{99.9}) FOR 99.9 PERCENT INACTIVATION OF GIARDIA LAMBLIA CYSTS BY FREE CHLORINE AT 5.0 °C¹

Free Residual (mg/l)	pH						
	≤6.0	6.5	7.0	7.5	8.0	8.5	≤9.0
≤0.4	97	117	139	166	198	236	279
0.6	100	120	143	171	204	244	291
0.8	103	122	146	175	210	252	301
1.0	105	125	149	179	216	260	312
1.2	107	127	152	183	221	267	320
1.4	109	130	155	187	227	274	329
1.6	111	132	158	192	232	281	337
1.8	114	135	162	196	238	287	345
2.0	116	138	165	200	243	294	353
2.2	118	140	169	204	248	300	361
2.4	120	143	172	209	253	306	368
2.6	122	146	175	213	258	312	375
2.8	124	148	178	217	263	318	382
3.0	126	151	182	221	268	324	389

¹ These CT values achieve greater than a 99.99 percent inactivation of viruses. CT values between the indicated pH values may be determined by linear interpolation. CT values between the indicated temperatures of different tables may be determined by linear interpolation. If no interpolation is used, use the CT_{99.9} value at the lower temperature, and at the higher pH.

TABLE 1.3—CT VALUES (CT_{99.9}) FOR 99.9 PERCENT INACTIVATION OF GIARDIA LAMBLIA CYSTS BY FREE CHLORINE AT 10.0 °C ¹

Free Residual (mg/l)	pH						
	≤6.0	6.5	7.0	7.5	8.0	8.5	≤9.0
≤0.4	73	88	104	125	149	177	209
0.6	75	90	107	128	153	183	218
0.8	78	92	110	131	158	189	226
1.0	79	94	112	134	162	195	234
1.2	80	95	114	137	166	200	240
1.4	82	98	116	140	170	206	247
1.6	83	99	119	144	174	211	253
1.8	86	101	122	147	179	215	259
2.0	87	104	124	150	182	221	265
2.2	89	105	127	153	186	225	271
2.4	90	107	129	157	190	230	276
2.6	92	110	131	160	194	234	281
2.8	93	111	134	163	197	239	287
3.0	95	113	137	166	201	243	292

¹ These CT values achieve greater than a 99.99 percent inactivation of viruses. CT values between the indicated pH values may be determined by linear interpolation. CT values between the indicated temperatures of different tables may be determined by linear interpolation. If no interpolation is used, use the CT_{99.9} value at the lower temperature, and at the higher pH.

TABLE 1.4—CT VALUES (CT_{99.9}) FOR 99.9 PERCENT INACTIVATION OF GIARDIA LAMBLIA CYSTS BY FREE CHLORINE AT 15.0 °C ¹

Free Residual (mg/l)	pH						
	≤6.0	6.5	7.0	7.5	8.0	8.5	≤9.0
≤0.4	49	59	70	83	99	118	140
0.6	50	60	72	86	102	122	146
0.8	52	61	73	88	105	126	151
1.0	53	63	75	90	108	130	156
1.2	54	64	76	92	111	134	160
1.4	55	65	78	94	114	137	165
1.6	56	66	79	96	116	141	169
1.8	57	68	81	98	119	144	173
2.0	58	69	83	100	122	147	177
2.2	59	70	85	102	124	150	181
2.4	60	72	86	105	127	153	184
2.6	61	73	88	107	129	156	188
2.8	62	74	89	109	132	159	191
3.0	63	76	91	111	134	162	195

¹ These CT values achieve greater than a 99.99 percent inactivation of viruses. CT values between the indicated pH values may be determined by linear interpolation. CT values between the indicated temperatures of different tables may be determined by linear interpolation. If no interpolation is used, use the CT_{99.9} value at the lower temperature, and at the higher pH.

TABLE 1.5—CT VALUES (CT_{99.9}) FOR 99.9 PERCENT INACTIVATION OF GIARDIA LAMBLIA CYSTS BY FREE CHLORINE AT 20.0 °C ¹

Free Residual (mg/l)	pH						
	≤6.0	6.5	7.0	7.5	8.0	8.5	≤9.0

Free Residual (mg/l)	pH						
	≤6.0	6.5	7.0	7.5	8.0	8.5	≤9.0
≤0.4	36	44	52	62	74	89	105
0.6	38	45	54	64	77	92	109
0.8	39	46	55	66	79	95	113
1.0	39	47	56	67	81	98	117
1.2	40	48	57	69	83	100	120
1.4	41	49	58	70	85	103	123
1.6	42	50	59	72	87	105	126
1.8	43	51	61	74	89	108	129
2.0	44	52	62	75	91	110	132
2.2	44	53	63	77	93	113	135
2.4	45	54	65	78	95	115	138
2.6	46	55	66	80	97	117	141
2.8	47	56	67	81	99	119	143
3.0	47	57	68	83	101	122	146

¹ These CT values achieve greater than a 99.99 percent inactivation of viruses. CT values between the indicated pH values may be determined by linear interpolation. CT values between the indicated temperatures of different tables may be determined by linear interpolation. If no interpolation is used, use the CT_{99,9} value at the lower temperature, and at the higher pH.

TABLE 1.6—CT VALUES (CT_{99,9}) FOR 99.9 PERCENT INACTIVATION OF GIARDIA LAMBLIA CYSTS BY FREE CHLORINE AT 25.0 °C¹ AND HIGHER.

Free Residual (mg/l)	pH						
	≤6.0	6.5	7.0	7.5	8.0	8.5	≤9.0
≤0.4	24	29	35	42	50	59	70
0.6	25	30	36	43	51	61	73
0.8	26	31	37	44	53	63	75
1.0	26	31	37	45	54	65	78
1.2	27	32	38	46	55	67	80
1.4	27	33	39	47	57	69	82
1.6	28	33	40	48	58	70	84
1.8	29	34	41	49	60	72	86
2.0	29	35	41	50	61	74	88
2.2	30	35	42	51	62	75	90
2.4	30	36	43	52	63	77	92
2.6	31	37	44	53	65	78	94
2.8	31	37	45	54	66	80	96
3.0	32	38	46	55	67	81	97

¹ These CT values achieve greater than a 99.99 percent inactivation of viruses. CT values between the indicated pH values may be determined by linear interpolation. CT values between the indicated temperatures of different tables may be determined by linear interpolation. If no interpolation is used, use the CT_{99,9} value at the lower temperature, and at the higher pH.

TABLE 2.1—CT VALUES (CT_{99,9}) FOR 99.9 PERCENT INACTIVATION OF GIARDIA LAMBLIA CYSTS BY CHLORINE DIOXIDE AND OZONE

	Temperature					
	≤1°C	5°C	10°C	15°C	20°C	≥25°C
Chlorine dioxide	63	26	23	19	15	11
Ozone	2.9	1.9	1.4	0.95	0.72	0.48

¹ These CT values achieve greater than 99.99 percent inactivation of viruses. CT values between the indicated temperatures may be determined by linear interpolation. If no interpolation is used, use the CT_{99.9} value at the lower temperature for determining CT_{99.9} values between indicated temperatures.

TABLE 3.1—CT VALUES (CT_{99.9}) FOR 99.9 PERCENT INACTIVATION OF GIARDIA LAMBLIA CYSTS BY CHLORAMINES ¹

Temperature						
<1°C	5°C	10°C	15°C	20°C	25°C	
3,800	2,200	1,850	1,500	1,100	750	

¹ These values are for pH values of 6 to 9. These CT values may be assumed to achieve greater than 99.99 percent inactivation of viruses only if chlorine is added and mixed in the water prior to the addition of ammonia. If this condition is not met, the system shall demonstrate, based on on-site studies or other information, as approved by the Department, that the system is achieving at least 99.99 percent inactivation of viruses. CT values between the indicated temperatures may be determined by linear interpolation. If no interpolation is used, use the CT_{99.9} value at the lower temperature for determining CT_{99.9} values between indicated temperatures.

(d) The total inactivation ratio shall be calculated as follows:

(i) If the system uses only one point of disinfectant application, the system may determine the total inactivation ratio based on either of the following two methods:

(A) One inactivation ratio (CT_{calc}/CT_{99.9}) is determined before or at the first customer during peak hourly flow and if the CT_{calc}/CT_{99.9} ≥ the 99.9 percent Giardia lamblia inactivation requirement has been achieved; or

(B) Successive CT_{calc}/CT_{99.9} values, representing sequential inactivation ratios, are determined between the point of disinfectant application and a point before or at the first customer during peak hourly flow. Under this alternative, the following method shall be used to calculate the total inactivation ratio:

- Step 1: Determine $\frac{CT_{calc}}{CT_{99.9}}$ for each sequence.
- Step 2: Add the $\frac{CT_{calc}}{CT_{99.9}}$ values together
- $\Sigma \frac{CT_{calc}}{CT_{99.9}}$
- Step 3: If $\Sigma \frac{CT_{calc}}{CT_{99.9}} \geq 1.0$,

the 99.9 percent Giardia lamblia inactivation requirement has been achieved.

(ii) If the system uses more than one point of disinfectant application before or at the first customer, the system shall determine the CT value of each disinfection sequence immediately prior to the next point of disinfectant application during peak hourly flow. The CT_{calc}/CT_{99.9} value of each sequence and

$$\Sigma \frac{CT_{calc}}{CT_{99.9}}$$

shall be calculated using the method in paragraph (2)(d)(i)(B) of this section to determine if the system is in compliance with R.61-58.10(D)(1).

(iii) Although not required, the total percent inactivation for a system with one or more points of residual disinfectant concentration monitoring may be calculated by solving the following equation:

$$\text{Percent inactivation} = 100 - \frac{100}{10^z}$$

$$\text{where } z = 3 \times \Sigma \frac{CT_{\text{calc}}}{CT_{99.9}}$$

(e) The residual disinfectant concentration of the water entering the distribution system shall be monitored continuously, and the lowest value shall be recorded each day, except that if there is a failure in the continuous monitoring equipment, grab sampling every 4 hours may be conducted in lieu of continuous monitoring, but for no more than 5 working days following the failure of the equipment, and systems serving 3,300 or fewer persons may take grab samples in lieu of providing continuous monitoring on an ongoing basis at the frequencies prescribed below:

System size by population	Samples/day ¹
≤500	1
501 to 1,000	2
1,001 to 2,500	3
2,501 to 3,300	4

¹The day's samples cannot be taken at the same time. The sampling intervals are subject to Department review and approval.

If at any time the residual disinfectant concentration falls below 0.2 mg/l in a system using grab sampling in lieu of continuous monitoring, the system shall take a grab sample every 4 hours until the residual concentration is equal to or greater than 0.2 mg/l.

(f) (i) Until March 31, 2016, the residual disinfectant concentration shall be measured at least at the same points in the distribution system and at the same time as total coliforms are sampled, as specified in R.61-58.5.G. Beginning April 1, 2016, the residual disinfectant concentration shall be measured at least at the same points in the distribution system and at the same time as total coliforms are sampled, as specified in R.61-58.17.E through R.61-58.17.I. The Department may allow a public water system which uses both a surface water source or a ground water source under the direct influence of surface water, and a ground water source, to take disinfectant residual samples at points other than the total coliform sampling points if the Department determines that such points are more representative of treated (disinfected) water quality within the distribution system. Heterotrophic bacteria, measured as heterotrophic plate count (HPC) as specified in R.61-58.10.F(1), may be measured in lieu of residual disinfectant concentration.

(ii) If the Department determines, based on site-specific considerations, that a system has no means for having a sample transported and analyzed for HPC by a certified laboratory under the requisite time and temperature conditions specified by paragraph (1)(c) of this section and that the system is providing adequate disinfection in the distribution system, the requirements of paragraph (2)(f)(i) of this section do not apply to that system.

(3) Monitoring requirements for systems using filtration treatment.

A public water system that uses a surface water source or a ground water source under the influence of surface water and provides filtration treatment shall monitor in accordance with this paragraph beginning June 29, 1993, or when filtration is installed, whichever is later.

(a) Turbidity measurements as required by R.61-58.10(E) shall be performed on representative samples of the system's filtered water every four hours (or more frequently) that the system serves water to the public. A public water system may substitute continuous turbidity monitoring for grab sample monitoring if it validates the continuous measurement for accuracy on a regular basis using a protocol approved by the Department. For any systems using slow sand filtration or filtration treatment other than conventional treatment, direct filtration, or diatomaceous earth filtration, the Department may reduce the sampling frequency to once per day if it determines that less frequent monitoring is sufficient to indicate effective filtration performance. For systems serving 500 or fewer persons, the Department may reduce the turbidity sampling frequency to

once per day, regardless of the type of filtration treatment used if the Department determines that less frequent monitoring is sufficient to indicate effective filtration performance.

(b) The residual disinfectant concentration of the water entering the distribution system shall be monitored continuously, and the lowest value shall be recorded each day, except that if there is a failure in the continuous monitoring equipment, grab sampling every 4 hours may be conducted in lieu of continuous monitoring, but for no more than 5 working days following the failure of the equipment, and systems serving 3,300 or fewer persons may take grab samples in lieu of providing continuous monitoring on an ongoing basis at the frequencies each day prescribed below:

System size by population	Samples/day ¹
≤500	1
501 to 1,000	2
1,001 to 2,500	3
2,501 to 3,300	4

¹The day's samples cannot be taken at the same time. The sampling intervals are subject to Department review and approval.

If at any time the residual disinfectant concentration falls below 0.2 mg/l in a system using grab sampling in lieu of continuous monitoring, the system shall take a grab sample every 4 hours until the residual disinfectant concentration is equal to or greater than 0.2 mg/l.

(c) (i) Until March 31, 2016, the residual disinfectant concentration shall be measured at least at the same points in the distribution system and at the same time as total coliforms are sampled, as specified in R.61-68.5.G. Beginning April 1, 2016, the residual disinfectant concentration shall be measured at least at the same points in the distribution system and at the same time as total coliforms are sampled, as specified in R.61-58.17.E through R.61-58.17.I. The Department may allow a public water system which uses both a surface water source or a ground water source under the direct influence of surface water, and a ground water source to take disinfectant residual samples at points other than the total coliform sampling points if the Department determines that such points are more representative of treated (disinfected) water quality within the distribution system. Heterotrophic bacteria, measured as heterotrophic plate count (HPC) as specified in R.61-58.10.F(1), may be measured in lieu of residual disinfectant concentration.

(ii) If the Department determines, based on site-specific considerations, that a system has no means for having a sample transported and analyzed for HPC by a certified laboratory under the requisite time and temperature conditions specified by paragraph (1)(c) of this section and that the system is providing adequate disinfection in the distribution system, the requirements of paragraph (3)(c)(i) of this section do not apply to that system.

G. Reporting and Recordkeeping Requirements.

(1) A public water system that uses a surface water source and does not provide filtration treatment shall report monthly to the Department the information specified in this paragraph beginning December 31, 1990, unless the Department has determined in writing that filtration is required, in which case the Department may specify alternative reporting requirements, as appropriate, until filtration is in place. A public water system that uses a ground water source under the direct influence of surface water and does not provide filtration treatment shall report monthly to the Department the information specified in this paragraph beginning December 31, 1990, or 6 months after the Department determines that the ground water source is under the direct influence of surface water, whichever is later, unless the Department has determined, in writing, that filtration is required, in which case the Department may specify alternative reporting requirements, as appropriate, until filtration is in place.

(a) Source water quality information shall be reported to the Department within 10 days after the end of each month the system serves water to the public. Information that shall be reported includes:

(i) The cumulative number of months for which results are reported.

(ii) The number of fecal and/or total coliform samples, whichever are analyzed during the month (if a system monitors for both, only fecal coliforms must be reported), the dates of sample collection, and the dates when the turbidity level exceeded 1 NTU.

(iii) The number of samples during the month that had equal to or less than $20/100$ ml fecal coliforms and/or equal to or less than $100/100$ ml total coliforms, whichever are analyzed.

(iv) The cumulative number of fecal or total coliform samples, whichever are analyzed, during the previous six months the system served water to the public.

(v) The cumulative number of samples that had equal to or less than $20/100$ ml fecal coliforms or equal to or less than $100/100$ ml total coliforms, whichever are analyzed, during the previous six months the system served water to the public.

(vi) The percentage of samples that had equal to or less than $20/100$ ml fecal coliforms or equal to or less than $100/100$ ml total coliforms, whichever are analyzed, during the previous six months the system served water to the public.

(vii) The maximum turbidity level measured during the month, the date(s) of occurrence for any measurement(s) which exceeded 5 NTU, and the date(s) the occurrence(s) was reported to the Department.

(viii) For the first 12 months of recordkeeping, the dates and cumulative number of events during which the turbidity exceeded 5 NTU, and after one year of recordkeeping for turbidity measurements, the dates and cumulative number of events during which the turbidity exceeded 5 NTU in the previous 12 months the system served water to the public.

(ix) For the first 120 months of recordkeeping, the dates and cumulative number of events during which the turbidity exceeded 5 NTU, and after 10 years of recordkeeping for turbidity measurements, the dates and cumulative number of events during which the turbidity exceeded 5 NTU in the previous 120 months the system served water to the public.

(b) Disinfection information specified in R.61-58.10(F)(2) shall be reported to the Department within 10 days after the end of each month the system serves water to the public. Information that shall be reported includes:

(i) For each day, the lowest measurement of residual disinfectant concentration in mg/l in water entering the distribution system.

(ii) The date and duration of each period when the residual disinfectant concentration in water entering the distribution system fell below 0.2 mg/l and when the Department was notified of the occurrence.

(iii) The daily residual disinfectant concentration(s) (in mg/l) and disinfectant contact time(s) (in minutes) used for calculating the CT value(s).

(iv) If chlorine is used, the daily measurement(s) of pH of disinfected water following each point of chlorine disinfection.

(v) The daily measurement(s) of water temperature in °C following each point of disinfection.

(vi) The daily CT_{calc} and CT_{calc}/CT_{99.9} values for each disinfectant measurement or sequence and the sum of all CT_{calc}/CT_{99.9} values [radicle (CT_{calc}/CT_{99.9})] before or at the first customer.

(vii) The daily determination of whether disinfection achieves adequate Giardia cyst and virus inactivation, i.e., whether (CT_{calc}/CT_{99.9}) is at least 1.0 or, where disinfectants other than chlorine are used, other indicator conditions that the Department determines are appropriate, are met.

(viii) The following information on the samples taken in the distribution system in conjunction with total coliform monitoring pursuant to R.61-58.10(D):

(A) Number of instances where the residual disinfectant concentration is measured;

(B) Number of instances where the residual disinfectant concentration is not measured but heterotrophic bacteria plate count (HPC) is measured;

(C) Number of instances where the residual disinfectant concentration is measured but not detected and no HPC is measured;

(D) Number of instances where no residual disinfectant concentration is detected and where HPC is ≥ 500 /ml;

(E) Number of instances where the residual disinfectant concentration is not measured and HPC is ≥ 500 /ml;

(F) For the current and previous month the system served water to the public, the value of “V” in the following formula:

$$V = \frac{c + d + e}{a + b} \times 100$$

where:

- a = the value in paragraph (1)(b)(viii)(A) of this section;
- b = the value in paragraph (1)(b)(viii)(B) of this section;
- c = the value in paragraph (1)(b)(viii)(C) of this section;
- d = the value in paragraph (1)(b)(viii)(D) of this section; and
- e = the value in paragraph (1)(b)(viii)(E) of this section.

(G) If the Department determines, based on site-specific considerations, that a system has no means for having a sample transported and analyzed for HPC by a certified laboratory under the requisite time and temperature conditions specified by R.61-58.10(F)(1)(c) and that the system is providing adequate disinfection in the distribution system, the requirements of paragraph (1)(b)(viii)(A)-(F) of this section do not apply to that system.

(ix) A system need not report the data listed in paragraphs (1)(b)(i), and (iii)-(vi) of this section if all data listed in paragraphs (1)(b)(i)-(viii) of this section remain on file at the system, and the Department determines that:

(A) The system has submitted to the Department all the information required by paragraphs (1)(b)(i)-(viii) of this section for at least 12 months; and

(B) The Department has determined that the system is not required to provide filtration treatment.

(c) No later than October 10 of each year, each system shall provide to the Department a report which summarizes its compliance with all watershed control program requirements specified in R.61-58.10(C)(2)(b).

(d) No later than October 10 of each year, each system shall provide to the Department a report on the on-site inspection conducted during that year pursuant to R.61-58.10(C) (2)(c), unless the on-site inspection was conducted by the Department. If the inspection was conducted by the Department, the Department shall provide a copy of its report to the public water system.

(e)(i) Each system, upon discovering that a waterborne disease outbreak potentially attributable to that water system has occurred, shall report that occurrence to the Department as soon as possible, but no later than by the end of the next business day.

(ii) If at any time the turbidity exceeds 5 NTU, the system shall inform the Department as soon as possible, but no later than the end of the next business day.

(iii) If at any time the residual falls below 0.2 mg/l in the water entering the distribution system, the system shall notify the Department as soon as possible, but no later than by the end of the next business day. The system also shall notify the Department by the end of the next business day whether or not the residual was resorted to at least 0.2 mg/l within 4 hours.

(iv) If at any time the turbidity exceeds 5 NTU, the system must consult with the primary agency as soon as practical, but no later than 24 hours after the exceedance is known, in accordance with the public notification requirements under R.61-58.6.E(3)(b)(iii).

(2) A public water system that uses a surface water source or a ground water source under the direct influence of surface water and provides filtration treatment shall report monthly to the Department the information specified in this paragraph beginning June 29, 1993, or when filtration is installed, whichever is later.

(a) Turbidity measurements as required by R.61-58.10(F)(3)(a) shall be reported within 10 days after the end of each month the system serves water to the public. Information that shall be reported includes:

(i) The total number of filtered water turbidity measurements taken during the month.

(ii) The number and percentage of filtered water turbidity measurements taken during the month which are less than or equal to the turbidity limits specified in R.61-58.10(E) for the filtration technology being used.

(iii) The date and value of any turbidity measurements taken during the month which exceed 5 NTU.

(b) Disinfection information specified in R.61-58.10(F)(3) shall be reported to the Department within 10 days after the end of each month the system serves water to the public. Information that shall be reported includes:

(i) For each day, the lowest measurement of residual disinfectant concentration in mg/l in water entering the distribution system.

(ii) The date and duration of each period when the residual disinfectant concentration in water entering the distribution system fell below 0.2 mg/l and when the Department was notified of the occurrence.

(iii) The following information on the samples taken in the distribution system in conjunction with total coliform monitoring pursuant to R.61-58.10(D):

(A) Number of instances where the residual disinfectant concentration is measured;

(B) Number of instances where the residual disinfectant concentration is not measured but heterotrophic bacteria plate count (HPC) is measured;

(C) Number of instances where the residual disinfectant concentration is measured but not detected and no HPC is measured;

(D) Number of instances where no residual disinfectant concentration is detected and where HPC is ≥ 500 /ml;

(E) Number of instances where the residual disinfectant concentration is not measured and HPC is ≥ 500 /ml;

(F) For the current and previous month the system serves water to the public, the value of "V" in the following formula:

$$V = \frac{c + d + e}{a + b} \times 100$$

where

a = the value in paragraph (2)(b)(iii)(A) of this section;

b = the value in paragraph (2)(b)(iii)(B) of this section;

c = the value in paragraph (2)(b)(iii)(C) of this section;

d = the value in paragraph (2)(b)(iii)(D) of this section; and

e = the value in paragraph (2)(b)(iii)(E) of this section.

(G) If the Department determines, based on site-specific considerations, that a system has no means for having a sample transported and analyzed for HPC by a certified laboratory within the requisite time and temperature conditions specified by R.61-58.10(F)(1)(c) and that the

system is providing adequate disinfection in the distribution system, the requirements of paragraph (2)(b)(iii)(A)-(F) of this section do not apply.

(iv) A system need not report the data listed in paragraph (2)(b)(i) of this section if all data listed in paragraphs (2)(b)(i)-(iii) of this section remain on file at the system and the Department determines that the system has submitted all the information required by paragraphs (2)(b)(i)-(iii) of this section for at least 12 months.

(c)(i) Each system, upon discovering that a waterborne disease outbreak potentially attributable to that water system has occurred, shall report that occurrence to the Department as soon as possible, but no later than by the end of the next business day.

(ii) If at any time the turbidity exceeds 5 NTU, the system shall inform the Department as soon as possible, but no later than the end of the next business day.

(iii) If at any time the residual falls below 0.2 mg/l in the water entering the distribution system, the system shall notify the Department as soon as possible, but no later than by the end of the next business day. The system also shall notify the Department by the end of the next business day whether or not the residual was restored to at least 0.2 mg/l within 4 hours.

(iv) If at any time the turbidity exceeds 5 NTU, the system must consult with the primacy agency as soon as practical, but no later than 24 hours after the exceedance is known, in accordance with the public notification requirements under R.61-58.6.E(3)(b)(iii).

H. Enhanced Filtration and Disinfection—Systems Serving 10,000 or More People (Interim Enhanced Surface Water Treatment Rule)

(1) General requirements.

(a) The requirements of these regulations constitute national primary drinking water regulations. These regulations establish requirements for filtration and disinfection that are in addition to criteria under which filtration and disinfection are required under Sections B through G above. The requirements of this section are applicable to public water systems supplied by a surface water source and public water systems supplied by a ground water source under the direct influence of surface water serving at least 10,000 people, beginning January 1, 2002 unless otherwise specified. These regulations establish or extend treatment technique requirements in lieu of maximum contaminant levels for the following contaminants: *Giardia lamblia*, viruses, heterotrophic plate count bacteria, *Legionella*, *Cryptosporidium*, and turbidity. Each public water system supplied by a surface water source or a ground water source under the direct influence of surface water system serving at least 10,000 people must provide treatment of its source water that complies with these treatment technique requirements and are in addition to those identified in Sections B through G above. The treatment technique requirements consist of installing and properly operating water treatment processes which reliably achieve:

(i) At least 99 percent (2-log) removal of *Cryptosporidium* between a point where the raw water is not subject to recontamination by surface water runoff and a point downstream before or at the first customer for filtered systems, or *Cryptosporidium* control under the watershed control plan for unfiltered systems.

(ii) Compliance with the profiling and benchmark requirements under the provisions of paragraph (3) of this section.

(b) A public water system subject to the requirements of these regulations is considered to be in compliance with the requirements of paragraph (1) of this section if:

(i) It meets the requirements for avoiding filtration in R.61-58.10(C) and R.61-58.10(H)(2) and the disinfection requirements in R.61-58.10(D) and R.61-58.10(H)(3); or

(ii) It meets the applicable filtration requirements in either R.61-58.10(E) or R.61-58.10(H)(4) and the disinfection requirements in R.61-58.10(D) and R.61-58.10(H)(3).

(c) Systems are not permitted to begin construction of uncovered finished water storage facilities beginning February, 16, 1999.

(d) Systems with a surface water source or a ground water source under the direct influence of surface water that did not conduct optional monitoring under Section H(3) because they served fewer than 10,000 persons when such monitoring was required, but served at least 10,000 persons prior to January 1, 2005 must comply with Section H. These systems must also consult with the

Department to establish a disinfection benchmark. A system that decides to make a significant change to its disinfection practice, as described in Section H(3)(c)(i) must consult with the Department prior to making such change.

(2) Criteria for avoiding filtration.

In addition to the requirements of R.61–58.10(C), a public water system subject to the requirements of this section that does not provide filtration must meet all of the conditions of paragraphs (2)(a) and (2)(b) of this section.

(a) Site-specific conditions. In addition to site-specific conditions in R.61–58.10(C)(2), systems must maintain the watershed control program under R.61–58.10(C)(2)(b) to minimize the potential for contamination by *Cryptosporidium* oocysts in the source water. The watershed control program must, for *Cryptosporidium*:

(i) Identify watershed characteristics and activities which may have an adverse effect on source water quality; and

(ii) Monitor the occurrence of activities which may have an adverse effect on source water quality.

(b) During the onsite inspection conducted under the provisions of R.61–58.10(C)(2)(c), the Department must determine whether the watershed control program established under 58.10(C)(2)(b) is adequate to limit potential contamination by *Cryptosporidium* oocysts. The adequacy of the program must be based on the comprehensiveness of the watershed review; the effectiveness of the system's program to monitor and control detrimental activities occurring in the watershed; and the extent to which the water system has maximized land ownership and/or controlled land use within the watershed.

(3) Disinfection profiling and benchmarking.

(a) Using data gathered from monitoring conducted by the Department during the time period of January 1, 1999 through March 1, 2000, any system having either a TTHM annual average greater than or equal to 0.064 mg/L or an HAA5 annual average greater than or equal to 0.048 mg/L during this period must comply with paragraph (3)(b) of this section.

(b) Disinfection profiling.

(i) Any system that meets the criteria in paragraph (3)(a) of this section must develop a disinfection profile of its disinfection practice for a period of up to three years.

(ii) The system must monitor daily for a period of twelve (12) consecutive calendar months to determine the total logs of inactivation for each day of operation, based on the CT_{99,9} values in Tables 1.1–1.6, 2.1, and 3.1 of R.61–58.10.F(2), as appropriate, through the entire treatment plant. This system must begin this monitoring not later than March 16, 2000. As a minimum, the system with a single point of disinfectant application prior to entrance to the distribution system must conduct the monitoring in paragraphs (3)(b)(ii) (A) through (D) of this section. A system with more than one point of disinfectant application must conduct the monitoring in paragraphs (3)(b)(i) through (iv) of this section for each disinfection segment. The system must monitor the parameters necessary to determine the total inactivation ratio, using EPA approved analytical methods specified in 40 CFR 141, as follows:

(A) The temperature of the disinfected water must be measured once per day at each residual disinfectant concentration sampling point during peak hourly flow.

(B) If the system uses chlorine, the pH of the disinfected water must be measured once per day at each chlorine residual disinfectant concentration sampling point during peak hourly flow.

(C) The disinfectant contact time(s) (“T”) must be determined for each day during peak hourly flow.

(D) The residual disinfectant concentration(s) (“C”) of the water before or at the first customer and prior to each additional point of disinfection must be measured each day during peak hourly flow.

(iii) In lieu of the monitoring conducted under the provisions of paragraph (b)(ii) of this section to develop the disinfection profile, the system may elect to meet the requirements of

paragraph (b)(iii)(A) of this section. In addition to the monitoring conducted under the provisions of paragraph (b)(ii) of this section to develop the disinfection profile, the system may elect to meet the requirements of paragraph (b)(iii)(B) of this section.

(A) A PWS that has three years of existing operational data may submit those data, a profile generated using those data, and a request that the State approve use of those data in lieu of monitoring under the provisions of paragraph (b)(2) of this section not later than March 16, 2000. The State must determine whether these operational data are substantially equivalent to data collected under the provisions of paragraph (b)(ii) of this section. These data must also be representative of *Giardia lamblia* inactivation through the entire treatment plant and not just of certain treatment segments. Until the State approves this request, the system is required to conduct monitoring under the provisions of paragraph (b)(ii) of this section.

(B) In addition to the disinfection profile generated under paragraph (3)(b)(ii) of this section, a PWS that has existing operational data may use those data to develop a disinfection profile for additional years. Such systems may use these additional yearly disinfection profiles to develop a benchmark under the provisions of paragraph (3)(c) of this section. The State must determine whether these operational data are substantially equivalent to data collected under the provisions of paragraph (3)(b)(ii) of this section. These data must also be representative of inactivation through the entire treatment plant and not just of certain treatment segments.

(iv) If the system uses only one point of disinfectant application, the system may determine the total inactivation ratio for the disinfection segment based on either of the methods in paragraph (3)(b)(iv)(A) or (3)(b)(iv)(B) of this section.

(A) Determine one inactivation ratio ($CT_{calc}/CT_{99.9}$) before or at the first customer during peak hourly flow.

(B) Determine successive $CT_{calc}/CT_{99.9}$ values, representing sequential inactivation ratios, between the point of disinfectant application and a point before or at the first customer during peak hourly flow. Under this alternative, the system must calculate the total inactivation ratio by determining ($CT_{calc}/CT_{99.9}$) for each sequence and then adding the ($CT_{calc}/CT_{99.9}$) values together to determine ($\sigma (CT_{calc}/CT_{99.9})$).

(v) If the system uses more than one point of disinfectant application before the first customer, the system must determine the CT value of each disinfection segment immediately prior to the next point of disinfectant application, or for the final segment, before or at the first customer, during peak hourly flow. The ($CT_{calc}/CT_{99.9}$) value of each segment and ($\Sigma (CT_{calc}/CT_{99.9})$) must be calculated using the method in paragraph (3)(b)(iv) of this section.

(vi) The system must determine the total logs of inactivation by multiplying the value calculated in paragraph (b)(iv)(A) or (B) of this section by 3.0.

(vii) A system that uses either chloramines or ozone for primary disinfection must also calculate the logs of inactivation for viruses using a method approved by the Department.

(viii) The system must retain disinfection profile data in graphic form, as a spreadsheet, or in some other format acceptable to the Department for review as part of the sanitary survey.

(c) Disinfection Benchmarking

(i) Any system required to develop a disinfection profile under the provisions of paragraphs (3)(a) and (3)(b) of this section and that decides to make a significant change to its disinfection practice must consult with the Department prior to making such change. Significant changes to disinfection practice are:

- (A) Changes to the point of disinfection;
- (B) Changes to the disinfectant(s) used in the treatment plant;
- (C) Changes to the disinfection process; and
- (D) Any other modification identified by the Department.

(ii) Any system that is modifying its disinfection practice must calculate its disinfection benchmark using the following procedure:

(A) For each year of profiling data collected and calculated under paragraph (b) of this section, the system must determine the lowest average monthly Giardia lamblia inactivation in each year of profiling data. The system must determine the average Giardia lamblia inactivation for each calendar month for each year of profiling data by dividing the sum of daily Giardia lamblia of inactivation by the number of values calculated for that month.

(B) The disinfection benchmark is the lowest monthly average value (for systems with one year of profiling data) or average of lowest monthly average values (for systems with more than one year of profiling data) of the monthly logs of Giardia lamblia inactivation in each year of profiling data.

(iii) A system that uses either chloramines or ozone for primary disinfection must also calculate the disinfection benchmark for viruses using a method approved by the Department.

(iv) The system must submit information in paragraphs (3)(c)(iv)(A) through (C) of this section to the Department as part of its consultation process.

(A) A description of the proposed change:

(B) The disinfection profile for Giardia lamblia (and, if necessary, viruses) under paragraph (b) of this section and benchmark as required by paragraph (c)(2) of this section; and

(C) An analysis of how the proposed change will affect the current levels of disinfection.

(4) Filtration

A public water system subject to the requirements of this section that does not meet all of the criteria in Section C above, and paragraph (2) of this section for avoiding filtration must provide treatment consisting of both disinfection, as specified in Section D above, and filtration treatment which complies with the requirements of paragraph 4(a) or 4(b) of this section or Section E (2) or (3) above, by December 31, 2001.

(a) Conventional filtration treatment or direct filtration.

(i) For systems using conventional filtration or direct filtration, the turbidity level of representative samples of a system's filtered water must be less than or equal to 0.3 NTU in at least ninety-five (95) percent of the measurements taken each month, measured as specified in Section F(1)(d) and (3)(a) above.

(ii) The turbidity level of representative samples of a system's filtered water must at no time exceed one (1) NTU, measured as specified in Section F(1)(d) and (3)(a) above.

(iii) A system that uses lime softening may acidify representative samples prior to analysis using a protocol approved by the Department.

(b) Filtration technologies other than conventional filtration treatment, direct filtration, slow sand filtration, or diatomaceous earth filtration.

A public water system may use a filtration technology not listed in paragraph (4)(a) of this section or in R.61-58.10(E) (2) or (3) if it demonstrates to the Department, using pilot plant studies or other means, that the alternative filtration technology, in combination with disinfection treatment that meets the requirements of R.61-58.10(D), consistently achieves 99.9 percent removal and/or inactivation of Giardia lamblia cysts and 99.99 percent removal and/or inactivation of viruses, and 99 percent removal of Cryptosporidium oocysts, and the Department approves the use of the filtration technology. For each approval, the Department will set turbidity performance requirements that the system must meet at least 95 percent of the time and that the system may not exceed at any time at a level that consistently achieves 99.9 percent removal and/or inactivation of Giardia lamblia cysts, 99.99 percent removal and/or inactivation of viruses, and 99 percent removal of Cryptosporidium oocysts.

(5) Filtration sampling requirements

(a) Monitoring requirements for systems using filtration treatment. In addition to monitoring required by Section F above, a public water system subject to the requirements of this section that provides conventional filtration treatment or direct filtration must conduct continuous monitoring of turbidity for each individual filter using an approved method in Section F above, and must calibrate turbidimeters using the procedure specified by the manufacturer. Systems must record the results of individual filter monitoring every fifteen (15) minutes.

(b) If there is a failure in the continuous turbidity monitoring equipment, the system must conduct grab sampling every four hours in lieu of continuous monitoring, but for no more than five working days following the failure of the equipment.

(6) Reporting and recordkeeping requirements.

In addition to the reporting and recordkeeping requirements in Section G above, a public water system subject to the requirements of this section that provides conventional filtration treatment or direct filtration must report monthly to the Department the information specified in paragraphs (6)(a) and (6)(b) of this section beginning December 31, 2001. In addition to the reporting and recordkeeping requirements in Section G above, a public water system subject to the requirements of this section that provides filtration approved under paragraph (4)(b) of this section must report monthly to the Department the information specified in paragraph (a) of this section beginning December 31, 2001. The reporting in paragraph (6)(a) of this section is in lieu of the reporting specified in Section G above.

(a) Turbidity measurements as required by paragraph (4) of this section must be reported within 10 days after the end of each month the system serves water to the public. Information that must be reported includes:

(i) The total number of filtered water turbidity measurements taken during the month.

(ii) The number and percentage of filtered water turbidity measurements taken during the month which are less than or equal to the turbidity limits specified in paragraph (4)(a) or (4)(b) of this section.

(iii) The date and value of any turbidity measurements taken during the month which exceed 1 NTU for systems using conventional filtration treatment or direct filtration, or which exceed the maximum level set by the Department under paragraph (4)(b) of this section.

(b) Systems must maintain the results of individual filter monitoring taken under paragraph (5) of this section for at least three years. Systems must report that they have conducted individual filter turbidity monitoring under paragraph (5) of this section within 10 days after the end of each month the system serves water to the public. Systems must report individual filter turbidity measurement results taken under paragraph (5) of this section within 10 days after the end of each month the system serves water to the public only if measurements demonstrate one or more of the conditions in paragraphs (6)(b)(i) through (iv) of this section. Systems that use lime softening may apply to the Department for alternative exceedance levels for the levels specified in paragraphs (6)(b)(i) through (iv) of this section if they can demonstrate that higher turbidity levels in individual filters are due to lime carryover only and not due to degraded filter performance.

(i) For any individual filter that has a measured turbidity level of greater than 1.0 NTU in two consecutive measurements taken 15 minutes apart, the system must report the filter number, the turbidity measurement, and the date(s) on which the exceedance occurred. In addition, the system must either produce a filter profile for the filter within 7 days of the exceedance (if the system is not able to identify an obvious reason for the abnormal filter performance) and report that the profile has been produced or report the obvious reason for the exceedance.

(ii) For any individual filter that has a measured turbidity level of greater than 0.5 NTU in two consecutive measurements taken 15 minutes apart at the end of the first four hours of continuous filter operation after the filter has been backwashed or otherwise taken offline, the system must report the filter number, the turbidity, and the date(s) on which the exceedance occurred. In addition, the system must either produce a filter profile for the filter within 7 days of the exceedance (if the system is not able to identify an obvious reason for the abnormal filter performance) and report that the profile has been produced or report the obvious reason for the exceedance.

(iii) For any individual filter that has a measured turbidity level of greater than 1.0 NTU in two consecutive measurements taken 15 minutes apart at any time in each of three consecutive months, the system must report the filter number, the turbidity measurement, and the date(s) on which the exceedance occurred. In addition, the system must conduct a self-assessment of the filter within 14 days of the exceedance and report that the self-assessment was conducted. The self assessment must consist of at least the following components; assessment of filter performance; development of a filter profile; identification and prioritization of factors limiting

filter performance; assessment of the applicability of corrections; and preparation of a filter self-assessment report.

(iv) For any individual filter that has a measured turbidity level of greater than 2.0 NTU in two consecutive measurements taken 15 minutes apart at any time in each of two consecutive months, the system must report the filter number, the turbidity measurement, and the date(s) on which the exceedance occurred. In addition, the system must arrange for the conduct of a comprehensive performance evaluation by the Department or a third party approved by the Department no later than 30 days following the exceedance and have the evaluation completed and submitted to the Department no later than 90 days following the exceedance.

(c) Additional reporting requirements.

(i) If at any time the turbidity exceeds one (1) NTU in representative samples of filtered water in a system using conventional filtration treatment or direct filtration, the system must inform the Department as soon as possible, but no later than the end of the next business day.

(ii) If at any time the turbidity in representative samples of filtered water exceeds the maximum level set by the Department under paragraph 4(b) of this section for filtration technologies other than conventional filtration treatment, direct filtration, slow sand filtration, or diatomaceous earth filtration, the system must inform the Department as soon as possible, but no later than the end of the next business day.

I. Enhanced Filtration and Disinfection—Systems Serving Fewer Than 10,000 People (Long Term 1 Enhanced Surface Water Treatment Rule)

(1) General Requirements

(a) The requirements of this regulation constitute national primary drinking water regulations. These regulations establish requirements for filtration and disinfection that are in addition to criteria under which filtration and disinfection are required for systems with surface water sources or ground water sources under the influence of surface water. This regulation establishes or extends treatment technique requirements in lieu of maximum contaminant levels for the following contaminants: *Giardia lamblia*, viruses, heterotrophic plate count bacteria, *Legionella*, *Cryptosporidium* and turbidity. The treatment technique requirements consist of installing and properly operating water treatment processes which reliably achieve:

(i) At least 99 percent (2 log) removal of *Cryptosporidium* between a point where the raw water is not subject to recontamination by surface water runoff and a point downstream before or at the first customer for filtered systems, or *Cryptosporidium* control under the watershed control plan for unfiltered systems; and

(ii) Compliance with the profiling and benchmark requirements in paragraphs (4) and (5) of this section.

(b) Who is subject to the requirements of this section?—You are subject to these requirements if your system:

(i) Is a public water system;

(ii) Uses surface water or GWUDI as a source; and

(iii) Serves fewer than 10,000 persons.

(c) When must my system comply with these requirements? You must comply with these requirements in this regulation beginning January 1, 2005 except where otherwise noted.

(d) What does this regulation require?—There are seven (7) requirements of this subpart, and you must comply with all requirements that are applicable to your system. These requirements are:

(i) You must cover any finished water reservoir that you began to construct on or after March 15, 2002 as described in paragraph (2) of this section;

(ii) If your system is an unfiltered system, you must comply with the updated watershed control requirements described in paragraph (3) of this section;

(iii) If your system is a community or non-transient non-community water systems you must develop a disinfection profile as described in paragraph (4) of this section;

(iv) If your system is considering making a significant change to its disinfection practices, you must develop a disinfection benchmark and consult with the Department for approval of the change as described in paragraph (5) of this section;

(v) If your system is a filtered system, you must comply with the combined filter effluent requirements as described in paragraph (6) of this section;

(vi) If your system is a filtered system that uses conventional or direct filtration, you must comply with the individual filter turbidity requirements as described in paragraph (7) of this section; and,

(vii) You must comply with the applicable reporting and recordkeeping requirements as described in paragraph (8) of this section.

(2) Finished Water Reservoirs

(a) Is my system subject to the new finished water reservoir requirements?—All surface water systems and ground water systems under the direct influence of surface water which serve fewer than 10,000 people are subject to this requirement.

(b) What is required of new finished water reservoirs?—If your system begins construction of a finished water reservoir on or after March 15, 2002 the reservoir must be covered. Finished water reservoirs for which your system began construction prior to March 15, 2002 are not subject to this requirement.

(3) Additional Watershed Control Requirements for Unfiltered Systems

(a) Is my system subject to the updated watershed control requirements?—If you are a surface water system or a ground water system under the direct influence of surface water serving fewer than 10,000 persons which does not provide filtration, you must continue to comply with all of the filtration avoidance criteria in Section C, as well as the additional watershed control requirements in paragraph (3)(b) of this section.

(b) What updated watershed control requirements must my unfiltered system implement to continue to avoid filtration?—Your system must take any additional steps necessary to minimize the potential for contamination by *Cryptosporidium* oocysts in the source water. Your system's watershed control program must, for *Cryptosporidium*:

(i) Identify watershed characteristics and activities which may have an adverse effect on source water quality; and

(ii) Monitor the occurrence of activities which may have an adverse effect on source water quality.

(c) How does the Department determine whether my system's watershed control requirements are adequate?—During an onsite inspection conducted under the provisions of Section C(2)(c), the Department must determine whether your watershed control program is adequate to limit potential contamination by *Cryptosporidium* oocysts. The adequacy of the program must be based on the comprehensiveness of the watershed review; the effectiveness of your program to monitor and control detrimental activities occurring in the watershed; and the extent to which your system has maximized land ownership and/or controlled land use within the watershed.

(4) Disinfection Profile

(a) What is a Disinfection Profile and who must develop one?—A disinfection profile is a graphical representation of your system's level of *Giardia lamblia* or virus inactivation measured during the course of a year. If you are a surface water system or a ground water system under the direct influence of surface water which serves fewer than 10,000 persons, your system must develop a disinfection profile unless the Department determines that your system's profile is unnecessary. The Department may approve the use of a more representative data set for disinfection profiling than the data set required under paragraph (4) (c) through (f) of this section.

(b) What criteria must the Department use to determine that a profile is unnecessary? The Department may only determine that a system's profile is unnecessary if a system's TTHM and HAA5 levels are below 0.064 mg/L and 0.048 mg/L, respectively. To determine these levels, TTHM and HAA5 samples must be collected after January 1, 1998, during the month with the warmest water temperature, and at the point of maximum residence time in your distribution

system. The Department may approve a more representative TTHM and HAA5 data set to determine these levels.

(c) How does my system develop a Disinfection Profile and when must it begin?—A disinfection profile consists of three steps:

(i) First, your system must collect data for several parameters from the plant as discussed in paragraph (4)(d) of this section, over the course of twelve (12) months. If your system serves between 500 and 9,999 persons you must begin to collect data no later than July 1, 2003. If your system serves fewer than 500 persons you must begin to collect data no later than January 1, 2004.

(ii) Second, your system must use this data to calculate weekly log inactivation as discussed in paragraphs (4)(e) and (f) of this section.

(iii) Third, your system must use these weekly log inactivations to develop a disinfection profile as specified in paragraph (4)(g) of this section.

(d) What data must my system collect to calculate a Disinfection Profile?—Your system must monitor the following parameters to determine the total log inactivation using the analytical methods in Section F, once per week on the same calendar day, over twelve (12) consecutive months:

(i) The temperature of the disinfected water at each residual disinfectant concentration sampling point during peak hourly flow;

(ii) If your system uses chlorine, the pH of the disinfected water at each residual disinfectant concentration sampling point during peak hourly flow;

(iii) The disinfectant contact time(s) ('T') during peak hourly flow; and

(iv) The residual disinfectant concentration(s) ('C') of the water before or at the first customer and prior to each additional point of disinfection during peak hourly flow.

(e) How does my system use this data to calculate an inactivation ratio? Use the tables in R-61.58.10.F(1)(c)(v) to determine the appropriate $CT_{99.9}$ value. Calculate the total inactivation ratio as follows, and multiply the value by 3.0 to determine log inactivation of *Giardia lamblia*:

If your system * * *	Your system must determine * * *
(a) Uses only one point of disinfectant application	(1) One inactivation ratio ($CT_{calc}/CT_{99.9}$) before or at the first customer during peak hourly flow or (2) Successive $CT_{calc}/CT_{99.9}$ values, representing sequential inactivation ratios, between the point of disinfectant application and a point before or at the first customer during peak hourly flow. Under this alternative, your system must calculate the total inactivation ratio by determining ($CT_{calc}/CT_{99.9}$) for each sequence and then adding the ($CT_{calc}/CT_{99.9}$) values together to determine ($\Sigma CT_{calc}/CT_{99.9}$).
(b) Uses more than one point of disinfectant application before the first customer	The ($CT_{calc}/CT_{99.9}$) value of each disinfection segment immediately prior to the next point of disinfectant application, or for the final segment, before or at the first customer, during peak hourly flow using the procedure specified in paragraph (a)(2) of this section.

(f) What if my system uses chloramines, ozone, or chlorine dioxide for primary disinfection?—If your system uses chloramines, ozone, or chlorine dioxide for primary disinfection, you must also calculate the logs of inactivation for viruses and develop an additional disinfection profile for viruses using methods approved by the Department.

(g) My system has developed an inactivation ratio; what must we do now?—Each log inactivation serves as a data point in your disinfection profile. Your system will have obtained fifty-two (52) measurements (one (1) for every week of the year). This will allow your system and the

Department the opportunity to evaluate how microbial inactivation varied over the course of the year by looking at all fifty-two (52) measurements (your Disinfection Profile). Your system must retain the Disinfection Profile data in graphic form, such as a spreadsheet, which must be available for review by the Department as part of a sanitary survey. Your system must use this data to calculate a benchmark if you are considering changes to disinfection practices.

(5) Disinfection Benchmark

(a) Who has to develop a Disinfection Benchmark?—If you are a surface water system or a ground water system under the direct influence of surface water you are required to develop a disinfection profile under paragraphs (4)(a) through (g) of this section. Your system must develop a Disinfection Benchmark if you decide to make a significant change to your disinfection practice. Your system must consult with the Department for approval before you can implement a significant disinfection practice change.

(b) What are significant changes to disinfection practice?—Significant changes to disinfection practice include:

- (i) Changes to the point of disinfection;
- (ii) Changes to the disinfectant(s) used in the treatment plant;
- (iii) Changes to the disinfection process; or
- (iv) Any other modification identified by the Department.

(c) What must my system do if we are considering a significant change to disinfection practices?—If your system is considering a significant change to its disinfection practice, your system must calculate a disinfection benchmark(s) as described in paragraphs (5)(c) and (d) of this section, and provide the benchmark(s) to the Department. Your system may only make a significant disinfection practice change after consulting with the Department for approval. Your system must submit the following information to the Department as part of the consultation and approval process:

- (i) A description of the proposed change;
- (ii) The disinfection profile for *Giardia lamblia* (and, if necessary, viruses) and disinfection benchmark;
- (iii) An analysis of how the proposed change will affect the current levels of disinfection; and
- (iv) Any additional information requested by the Department.

(d) How is the Disinfection Benchmark calculated?—If your system is making a significant change to its disinfection practice, it must calculate a disinfection benchmark using the procedure specified in the following table.

To calculate a disinfection benchmark your system must perform the following steps

- | | |
|---------|---|
| Step 1: | Using the data your system collected to develop the Disinfection Profile, determine the average <i>Giardia lamblia</i> inactivation for each calendar month by dividing the sum of all <i>Giardia lamblia</i> inactivations for that month by the number of values calculated for that month. |
| Step 2: | Determine the lowest monthly average value out of the twelve (12) values. This value becomes the disinfection benchmark. |

(e) What if my system uses chloramines, ozone, or chlorine dioxide for primary disinfection?—If your system uses chloramines, ozone or chlorine dioxide for primary disinfection your system must calculate the disinfection benchmark from the data your system collected for viruses to develop the disinfection profile in addition to the *Giardia lamblia* disinfection benchmark calculated under paragraph (5)(d) of this section. This viral benchmark must be calculated in the same manner used to calculate the *Giardia lamblia* disinfection benchmark in paragraph (5)(d) of this section.

(6) Combined Filter Effluent Requirements

(a) Is my system required to meet this regulation's combined filter effluent turbidity limits?—All surface water systems and ground water systems under the direct influence of surface water which serve populations fewer than 10,000, and that utilize filtration other than slow sand filtration or

diatomaceous earth filtration, must meet the combined filter effluent turbidity requirements of paragraphs (6)(b) through (d) of this section. If your system uses slow sand or diatomaceous earth filtration you are not required to meet the combined filter effluent turbidity limits of this regulation, but you must continue to meet the combined filter effluent turbidity limits in Section E.

(b) What strengthened combined filter effluent turbidity limits must my system meet?—Your system must meet two strengthened combined filter effluent turbidity limits.

(i) The first combined filter effluent turbidity limit is a “95th percentile” turbidity limit that your system must meet in at least ninety five (95) percent of the turbidity measurements taken each month. Measurements must continue to be taken as described in Section F(1) and (3). Monthly reporting must be completed according to paragraph (8) of this section. The following table describes the required limits for specific filtration technologies.

If your system consists of * * *	Your 95th percentile turbidity value is * * *
(1) Conventional Filtration or Direct Filtration	0.3 NTU
(2) All other ‘Alternative’ Filtration	A value determined by the Department (not to exceed 1 NTU) based on the demonstration described in paragraph (6)(c) of this section.

(ii) The second combined filter effluent turbidity limit is a “maximum” turbidity limit which your system may at no time exceed during the month. Measurements must continue to be taken as described in Sections F(1) and C. Monthly reporting must be completed according to paragraph (8) of this section. The following table describes the required limits for specific filtration technologies.

If your system consists of * * *	Your maximum turbidity value is * * *
(1) Conventional Filtration or Direct Filtration	1 NTU
(2) All other ‘Alternative’ Filtration	A value determined by the Department (not to exceed 5 NTU) based on the demonstration as described in paragraph (6)(c) of this section.

(c) My system consists of “alternative filtration” and is required to conduct a demonstration—what is required of my system and how does the Department establish my turbidity limits?—

(i) If your system consists of alternative filtration (filtration other than slow sand filtration, diatomaceous earth filtration, conventional filtration, or direct filtration) you are required to conduct a demonstration (see tables in paragraph (6)(b) of this section). Your system must demonstrate to the Department, using pilot plant studies or other means, that your system’s filtration, in combination with disinfection treatment, consistently achieves:

- (A) 99 percent removal of *Cryptosporidium* oocysts;
- (B) 99.9 percent removal and/or inactivation of *Giardia lamblia* cysts; and
- (C) 99.99 percent removal and/or inactivation of viruses.

(ii) [Reserved]

(d) My system practices lime softening—is there any special provision regarding my combined filter effluent?—If your system practices lime softening, you may acidify representative combined filter effluent turbidity samples prior to analysis using a protocol approved by the Department.

(7) Individual Filter Turbidity Requirements

(a) Is my system subject to individual filter turbidity requirements?—If your system is a surface water system or a ground water system under the direct influence of surface water serving fewer than 10,000 people and utilizing conventional filtration or direct filtration, you must conduct continuous monitoring of turbidity for each individual filter at your system. The following requirements apply to continuous turbidity monitoring:

- (i) Monitoring must be conducted using an approved method in Section F(1);
- (ii) Calibration of turbidimeters must be conducted using procedures specified by the manufacturer;
- (iii) Results of turbidity monitoring must be recorded at least every fifteen (15) minutes;
- (iv) Monthly reporting must be completed according to paragraph (8) of this section; and
- (v) Records must be maintained according to paragraph (8)(b) of this section.

(b) What happens if my system's turbidity monitoring equipment fails?—If there is a failure in the continuous turbidity monitoring equipment, your system must conduct grab sampling every four hours in lieu of continuous monitoring until the turbidimeter is back on-line. Your system has fourteen (14) days to resume continuous monitoring before a violation is incurred.

(c) My system only has two or fewer filters—is there any special provision regarding individual filter turbidity monitoring?—Yes, if your system only consists of two (2) or fewer filters, you may conduct continuous monitoring of combined filter effluent turbidity in lieu of individual filter effluent turbidity monitoring. Continuous monitoring must meet the same requirements set forth in paragraphs (7)(a) through (d) of this section.

(d) What follow-up action is my system required to take based on continuous turbidity monitoring? Follow-up action is required according to the following tables:

If * * *	Your system must * * *
(a) The turbidity of an individual filter (or the turbidity of combined filter effluent (CFE) for systems with 2 filters that monitor CFE in lieu of individual filters) exceeds 1.0 NTU in two consecutive recordings 15 minutes apart.	Report to the Department by the 10th of the following month and include the filter number(s), corresponding date(s), turbidity value(s) which exceeded 1.0 NTU, and the cause (if known) for the exceedance(s).

If a system was required to report to the Department * * *	Your system must * * *
(b) For three months in a row and turbidity exceeded 1.0 NTU in two consecutive recordings 15 minutes apart at the same filter (or CFE for systems with 2 filters that monitor CFE in lieu of individual filters).	Conduct a self-assessment of the filter(s) within 14 days of the day the filter exceeded 1.0 NTU in two consecutive measurements for the third straight month unless a CPE as specified in paragraph (c) of this section was required. Systems with 2 filters that monitor CFE in lieu of individual filters must conduct a self-assessment on both filters. The self-assessment must consist of at least the following components: assessment of filter performance; development of a filter profile; identification and prioritization of factors limiting filter performance; assessment of the applicability of corrections; and preparation of a filter self-assessment report.
(c) For two months in a row and turbidity exceeded 2.0 NTU in 2 consecutive recordings 15 minutes apart at the same filter (or CFE for systems with 2 filters that monitor CFE in lieu of individual filters).	Arrange to have a comprehensive performance evaluation (CPE) conducted by the Department or a third party approved by the Department not later than 60 days following the day the filter exceeded 2.0 NTU in two consecutive measurements for the second straight month. If a CPE has been completed by the Department or a third party approved by the Department within the 12 prior months or the system and the Department are jointly participating in an ongoing Comprehensive Technical Assistance (CTA) project at the system, a new CPE is not required. If conducted, a CPE must be completed and submitted to the Department no later than 120 days following

the day the filter exceeded 2.0 NTU in two consecutive measurements for the second straight month.

(e) My system practices lime softening—is there any special provision regarding my individual filter turbidity monitoring?—If your system utilizes lime softening, you may apply to the Department for alternative turbidity exceedance levels for the levels specified in the table in paragraph (7)(d) of this section. You must be able to demonstrate to the Department that higher turbidity levels are due to lime carryover only, and not due to degraded filter performance.

(8) Reporting and Recordkeeping Requirements

(a) What does this section require that my system report to the Department? This section requires your system to report several items to the Department. The following table describes the items which must be reported and the frequency of reporting. Your system is required to report the information described in the following table, if it is subject to the specific requirement shown in the first column.

Corresponding requirement	Description of information to report	Frequency
(a) Combined Filter Effluent Requirements. (paragraphs (6)(a) through (d) of this section).	(1) The total number of filtered water turbidity measurements taken during the month.	By the 10th of the following month.
	(2) The number and percentage of filtered water turbidity measurements taken during the month which are less than or equal to your system's required 95th percentile limit.	By the 10th of the following month.
	(3) The date and value of any turbidity measurements taken during the month which exceed the maximum turbidity value for your filtration system.	By the 10th of the following month
(b) Individual Turbidity Requirements. (paragraph (7)(a) through (e) of this section).	(1) That your system conducted individual filter turbidity monitoring during the month.	By the 10th of the following month.
	(2) The filter number(s), corresponding date(s), and the turbidity value(s) which exceeded 1.0 NTU during the month, and cause (if known) for the exceedance(s), but only if 2 consecutive measurements exceeded 1.0 NTU.	By the 10th of the following month.
	(3) If a self-assessment is required, the date that it was triggered and the date that it was completed.	By the 10th of the following month (or 14 days after the self-assessment was triggered only if the self-assessment was triggered during the last four days of the month)
	(4) If a CPE is required, that the CPE is required and the date that it was triggered.	By the 10th of the following month.

Corresponding requirement	Description of information to report	Frequency
	(5) Copy of completed CPE report	Within 120 days after the CPE was triggered.
(c) Disinfection Profiling (paragraphs (4)(a) through (g) of this section)	(1) Results of optional monitoring which show TTHM levels 0.064 mg/L and HAA5 levels 0.048 mg/L (only if your system wishes to forgo profiling) or that your system has begun disinfection profiling.	(i) For systems serving 500–9,999 by July 1, 2003; (ii) For systems serving fewer than 500 by January 1, 2004.
(d) Disinfection Benchmarking (paragraph (5)(a) through (e) of this section)	(1) A description of the proposed change in disinfection, your system’s disinfection profile for <i>Giardia lamblia</i> (and, if necessary, viruses) and disinfection benchmark, and an analysis of how the proposed change will affect the current levels of disinfection.	Anytime your system is considering a significant change to its disinfection practice.

(b) What records does this regulation require my system to keep?—Your system must keep several types of records based on the requirements of this regulation, in addition to recordkeeping requirements under Section G. The following table describes the necessary records, the length of time these records must be kept, and for which requirement the records pertain. Your system is required to maintain records described in this table, if it is subject to the specific requirement shown in the first column.

Corresponding requirement	Description of necessary records	Duration of time records must be kept
(a) Individual Filter Turbidity Requirements (paragraphs (7)(a) through (e) of this section)	Results of individual filter monitoring	At least 3 years.
(b) Disinfection Profiling (paragraphs (4)(a) through (g) of this section)	Results of Profile (including raw data and analysis)	Indefinitely.
(c) Disinfection Benchmarking (paragraphs (5)(a) through (e) of this section)	Benchmark (including raw data and analysis)	Indefinitely.

J. Recycle Provisions (Filter Backwash Recycling Rule)

(1) Applicability. All community water systems (CWSs) and non-transient, non-community waters systems (NTNCWSs) that employ conventional filtration or direct filtration treatment and that recycle spent filter backwash water, thickener supernatant, or liquids from dewatering processes must meet the requirements in paragraphs (2) through (4) of this section.

(2) Reporting. A system must notify the Department in writing by December 8, 2003, if the system recycles spent filter backwash water, thickener supernatant, or liquids from dewatering processes. This notification must include, at a minimum, the information specified in paragraphs (2)(a) and (b) of this section.

(a) A plant schematic showing the origin of all flows which are recycled (including, but not limited to, spent filter backwash water, thickener supernatant, and liquids from dewatering processes), the hydraulic conveyance used to transport them, and the location where they are re-introduced back into the treatment plant.

(b) Typical recycle flow in gallons per minute (gpm), the highest observed plant flow experienced in the previous year (gpm), design flow for the treatment plant (gpm), and Department-approved operating capacity for the plant where the Department has made such determinations.

(3) Treatment technique requirement. Any system that recycles spent filter backwash water, thickener supernatant, or liquids from dewatering processes must return these flows through the processes of a system's existing conventional or direct filtration system as defined in R.61-58.B or at an alternate location approved by the Department by June 8, 2004. If capital improvements are required to modify the recycle location to meet this requirement, all capital improvements must be completed no later than June 8, 2006.

(4) Recordkeeping. The system must collect and retain on file recycle flow information specified in paragraphs (4)(a) through (f) of this section for review and evaluation by the Department beginning June 8, 2004.

(a) Copy of the recycle notification and information submitted to the Department under paragraph (b) of this section.

(b) List of all recycle flows and the frequency with which they are returned.

(c) Average and maximum backwash flow rate through the filters and the average and maximum duration of the filter backwash process in minutes.

(d) Typical filter run length and a written summary of how filter run length is determined.

(e) The type of treatment provided for the recycle flow.

(f) Data on the physical dimensions of the equalization and/or treatment units, typical and maximum hydraulic loading rates, type of treatment chemicals used and average dose and frequency of use, and frequency at which solids are removed, if applicable.

K. Enhanced Treatment for Cryptosporidium (Long Term 2 Surface Water Treatment Rule)

(1) General Requirements

(a) The requirements of R.61-58.10.K are National Primary Drinking Water Regulations that establish or extend treatment technique requirements in lieu of maximum contaminant levels for Cryptosporidium. These requirements are in addition to requirements for filtration and disinfection in R.61-58.10 A through I.

(b) Applicability.

The requirements of R.61-58.10.K apply to all subpart H systems.

(i) Wholesale systems, as defined in R.61-58.B, must comply with the requirements of R.61-58.10.K based on the population of the largest system in the combined distribution system.

(ii) The requirements of R.61-58.10.K for filtered systems apply to systems required by State Primary Drinking Water Regulations to provide filtration treatment, whether or not the system is currently operating a filtration system.

(iii) The requirements of R.61-58.10.K for unfiltered systems apply only to unfiltered systems that timely met and continue to meet the filtration avoidance criteria in R.61-58.10.A through I, as applicable.

(c) Requirements.

Systems subject to R.61-58.10.K must comply with the following requirements:

(i) Systems must conduct an initial and a second round of source water monitoring for each plant that treats a surface water or ground water under direct influence (GWUDI) source. This monitoring may include sampling for Cryptosporidium, E. coli, and turbidity as described in R.61-58.10.K(2) through R.61-58.10.K(7), to determine what level, if any, of additional Cryptosporidium treatment they must provide.

(ii) Systems that plan to make a significant change to their disinfection practice must develop disinfection profiles and calculate disinfection benchmarks, as described in R.61-58.10.K(9) and (10).

(iii) Filtered systems must determine their Cryptosporidium treatment bin classification as described in R.61-58.10.K(11) and provide additional treatment for Cryptosporidium, if required, as described in R.61-58.10.K(12). All unfiltered systems must provide treatment for

Cryptosporidium as described in R.61-58.10.K(13). Filtered and unfiltered systems must implement Cryptosporidium treatment according to the schedule in R.61-58.10.K(14).

(iv) Systems with uncovered finished water storage facilities must comply with the requirements to cover the storage facility or treat the discharge from the storage facility as described in R.61-58.10.K(15).

(v) Systems required to provide additional treatment for Cryptosporidium must implement microbial toolbox options that are designed and operated as described in R.61-58.10.K(16) through R.61-58.10.K(21).

(vi) Systems must comply with the applicable recordkeeping and reporting requirements described in R.61-58.10.K(22) through R.61-58.10.K(23).

(vii) Systems must address significant deficiencies identified in sanitary surveys performed by EPA as described in R.61-58.10.K(24).

(2) Source Water Monitoring.

(a) Initial Source Monitoring.

Systems must conduct the following monitoring on the schedule in R.61-58.10.K(2)(c) unless they meet the monitoring exemption criteria in R.61-58.10.K(2)(d).

(i) Filtered systems serving at least 10,000 people must sample their source water for Cryptosporidium, E. coli, and turbidity at least monthly for 24 months.

(ii) Unfiltered systems serving at least 10,000 people must sample their source water for Cryptosporidium at least monthly for 24 months.

(iii) E.Coli Monitoring for Filtered Systems Serving Fewer Than 10,000 People.

(A) Filtered systems serving fewer than 10,000 people must sample their source water for E. coli at least once every two weeks for 12 months.

(B) A filtered system serving fewer than 10,000 people may avoid E. coli monitoring if the system notifies the Department that it will monitor for Cryptosporidium as described in R.61-58.10.K(2)(a)(4). The system must notify the Department no later than 3 months prior to the date the system is otherwise required to start E. coli monitoring under R.61-58.10.K(2)(c).

(iv) Filtered systems serving fewer than 10,000 people must sample their source water for Cryptosporidium at least twice per month for 12 months or at least monthly for 24 months if they meet one of the following criteria in (A) through (D) below, based on monitoring conducted under R.61-58.10.K(2)(a)(iii).

(A) For systems using lake/reservoir sources, the annual mean E. coli concentration is greater than 10 E. coli per 100 mL.

(B) For systems using flowing stream sources, the annual mean E. coli concentration is greater than 50 E. coli per 100 mL.

(C) The system does not conduct E. coli monitoring as described in R.61-58.10.K(2)(a)(iii).

(D) Systems using a GWUDI source must comply with the requirements of R.61-58.10.K(2)(a)(iv) based on the E. coli level that applies to the nearest surface water body. If no surface water body is nearby, the system must comply based on the requirements that apply to systems using lake or reservoir sources.

(v) For filtered systems serving fewer than 10,000 people, the Department may approve monitoring for an indicator other than E. coli under R.61-58.10.K(2)(a)(iii). The Department also may approve an alternative to the E. coli concentration in paragraph R.61-58.10.K(2)(a)(iv)(A), (B) or (D) to trigger Cryptosporidium monitoring. This approval by the Department must be in writing and will include the basis for the Department's determination that the alternative indicator and/or trigger level will provide a more accurate identification of whether a system will exceed the Bin 1 Cryptosporidium level in R.61-58.10.K(11).

(vi) Unfiltered systems serving fewer than 10,000 people must sample their source water for Cryptosporidium at least twice per month for 12 months or at least monthly for 24 months.

(vii) Systems may sample more frequently than required under this section if the sampling frequency is evenly spaced throughout the monitoring period.

(b) Second round of source water monitoring.

Systems must conduct a second round of source water monitoring that meets the requirements for monitoring parameters, frequency, and duration described in R.61-58.10.K(2)(a), unless they meet the monitoring exemption criteria in R.61-58.10.K(2)(d). Systems must conduct this monitoring on the schedule in R.61-58.10.K(2)(c).

(c) Monitoring Schedule

Systems must begin the monitoring required in R.61-58.10.K(2)(a) and (b) no later than the month beginning with the date listed in R.61-58.10.K(2)(c)(i) through (v).

(i) Systems that serve at least 100,000 people must begin the first round of source water monitoring no later than the month beginning October 1, 2006, and must begin the second round of source water monitoring no later than the month beginning April 1, 2015.

(ii) Systems that serve from 50,000 to 99,999 people must begin the first round of source water monitoring no later than the month beginning April 1, 2007, and must begin the second round of source water monitoring no later than the month beginning October 1, 2015.

(iii) Systems that serve from 10,000 to 49,999 people must begin the first round of source water monitoring no later than the month beginning April 1, 2008, and must begin the second round of source water monitoring no later than the month beginning October 1, 2016.

(iv) Systems that serve fewer than 10,000 people and monitor for *E. coli* (applies only to filtered systems) must begin the first round of source water monitoring no later than the month beginning October 1, 2008, and must begin the second round of source water monitoring no later than the month beginning October 1, 2017.

(v) Systems that serve fewer than 10,000 people and monitor for *Cryptosporidium* must begin the first round of source water monitoring no later than the month beginning April 1, 2010, and must begin the second round of source water monitoring no later than the month beginning April 1, 2019. (Applies to filtered systems that meet the conditions of R.61-58.10.K(2)(a)(iv) and unfiltered systems).

(d) Monitoring Avoidance.

(i) Filtered systems are not required to conduct source water monitoring under R.61-58.10.K if the system will provide a total of at least 5.5-log of treatment for *Cryptosporidium*, equivalent to meeting the treatment requirements of Bin 4 in R.61-58.10.K(12).

(ii) Unfiltered systems are not required to conduct source water monitoring under R.61-58.10.K if the system will provide a total of at least 3-log *Cryptosporidium* inactivation, equivalent to meeting the treatment requirements for unfiltered systems with a mean *Cryptosporidium* concentration of greater than 0.01 oocysts per L in R.61-58.10.K(13).

(iii) If a system chooses to provide the level of treatment in R.61-58.10.K(2)(d)(1) or (2), as applicable, rather than start source water monitoring, the system must notify the Department in writing no later than the date the system is otherwise required to submit a sampling schedule for monitoring under R.61-58.10.K(3). Alternatively, a system may choose to stop sampling at any point after it has initiated monitoring if it notifies the Department in writing that it will provide this level of treatment. Systems must install and operate technologies to provide this level of treatment by the applicable treatment compliance date in R.61-58.10.K(14).

(e) Plants Operating Only Part of the Year.

Systems with subpart H plants that operate for only part of the year must conduct source water monitoring in accordance with R.61-58.10.K with the following modifications:

(i) Systems must sample their source water only during the months that the plant operates unless the Department specifies another monitoring period based on plant operating practices.

(ii) Systems with plants that operate less than six months per year and that monitor for *Cryptosporidium* must collect at least six *Cryptosporidium* samples per year during each of two years of monitoring. Samples must be evenly spaced throughout the period the plant operates.

(f) New Sources.

(i) A system that begins using a new source of surface water or ground water under the direct influence of surface water after the system is required to begin monitoring under R.61-58.10.K(2)(c) must monitor the new source on a schedule approved by the Department. Source water monitoring must meet the requirements of R.61-58.10.K. The system must also meet the bin classification and Cryptosporidium treatment requirements of R.61-58.10.K(11) and R.61-58.10.K(12) or R.61-58.10.K(13), as applicable, for the new source on a schedule approved by the Department.

(ii) The requirements of R.61-58.10.K(2)(f) apply to subpart H systems that begin operation after the monitoring start date applicable to the system's size under R.61-58.10.K(2)(c).

(iii) The system must begin a second round of source water monitoring no later than 6 years following initial bin classification under R.61-58.10.K(11) or determination of the mean Cryptosporidium level under R.61-58.10.K(13), as applicable.

(g) Failure to collect any source water sample required under R.61-58.10.K(2) in accordance with the sampling schedule, sampling location, analytical method, approved laboratory, and reporting requirements of R.61-58.10.K(3) through R.61-58.10.K(7) is a monitoring violation.

(h) Grandfathering Monitoring Data.

Systems may use (grandfather) monitoring data collected prior to the applicable monitoring start date in R.61-58.10.K(2)(c) to meet the initial source water monitoring requirements in R.61-58.10.K(2)(a). Grandfathered data may substitute for an equivalent number of months at the end of the monitoring period. All data submitted under this paragraph must meet the requirements in R.61-58.10.K(8).

(3) Sampling Schedules.

(a) Systems required to conduct source water monitoring under R.61-58.10.K(2) must submit a sampling schedule that specifies the calendar dates when the system will collect each required sample.

(i) Systems must submit sampling schedules no later than 3 months prior to the applicable date listed in R.61-58.10.K(2)(c) for each round of required monitoring.

(ii) Electronic Submittal of Sample Schedules for Systems Serving at Least 10,000 People.

(A) Systems serving at least 10,000 people must submit their sampling schedule for the initial round of source water monitoring under R.61-58.10.K(2)(a) to EPA electronically.

(B) If a system is unable to submit the sampling schedule electronically, the system may use an alternative approach for submitting the sampling schedule that EPA approves.

(iii) Systems serving fewer than 10,000 people must submit their sampling schedules for the initial round of source water monitoring under R.61-58.10.K(2)(a) to the Department.

(iv) Systems must submit sampling schedules for the second round of source water monitoring under R.61-58.10.K(2)(b) to the Department.

(v) If EPA or the Department does not respond to a system regarding its sampling schedule, the system must sample according to the submitted schedule.

(b) Systems must collect samples within two days before or two days after the dates indicated in their sampling schedule (i.e., within a five-day period around the schedule date) unless one of the conditions of R.61-58.10.K(3)(b)(i) or (ii) applies.

(i) If an extreme condition or situation exists that may pose danger to the sample collector, or that cannot be avoided and causes the system to be unable to sample in the scheduled five-day period, the system must sample as close to the scheduled date as is feasible unless the Department approves an alternative sampling date. The system must submit an explanation for the delayed sampling date to the Department at the same time the sample is shipped to the laboratory.

(ii) Replacement Samples.

(A) If a system is unable to report a valid analytical result for a scheduled sampling date due to equipment failure, loss of or damage to the sample, failure to comply with the analytical method requirements, including the quality control requirements in

R.61-58.10.K(5), or the failure of an approved laboratory to analyze the sample, then the system must collect a replacement sample.

(B) The system must collect the replacement sample not later than 21 days after receiving information that an analytical result cannot be reported for the scheduled date unless the system demonstrates that collecting a replacement sample within this time frame is not feasible or the Department approves an alternative resampling date. The system must submit an explanation for the delayed sampling date to the Department at the same time the sample is shipped to the laboratory.

(c) Systems that fail to meet the criteria of R.61-58.10.K(3)(b) for any source water sample required under R.61-58.10.K(2) must revise their sampling schedules to add dates for collecting all missed samples. Systems must submit the revised schedule to the Department for approval prior to when the system begins collecting the missed samples.

(4) Sampling Locations.

(a) Systems required to conduct source water monitoring under R.61-58.K(2) must collect samples for each plant that treats a surface water or a GWUDI source. Where multiple plants draw water from the same influent, such as the same pipe or intake, the Department may approve one set of monitoring results to be used to satisfy the requirements of R.61-58.10.K(2) for all plants.

(b) Sampling Prior to Chemical Treatment.

(i) Systems must collect source water samples prior to chemical treatment, such as coagulants, oxidants and disinfectants, unless the system meets the condition of R.61-58.10.K(4)(b)(ii).

(ii) The Department may approve a system to collect a source water sample after chemical treatment if the Department determines that collecting a sample prior to chemical treatment is not feasible for the system and that the chemical treatment is unlikely to have a significant adverse effect on the analysis of the sample.

(c) Systems that recycle filter backwash water must collect source water samples prior to the point of filter backwash water addition.

(d) Bank Filtration.

(i) Systems that receive Cryptosporidium treatment credit for bank filtration under R.61-58.10.H(4)(b) or R.61-58.10.I(6)(c), as applicable, must collect source water samples in the source water prior to bank filtration.

(ii) Systems that use bank filtration as pretreatment to a filtration plant must collect source water samples from the well (i.e., after bank filtration). Use of bank filtration during monitoring must be consistent with routine operational practice. Systems collecting samples after a bank filtration process may not receive treatment credit for the bank filtration under R.61-58.10.K(18)(c).

(e) Multiple Sources.

Systems with plants that use multiple water sources, including multiple surface water sources and blended surface water and ground water sources, must collect samples as specified in R.61-58.10.K(4)(e)(i) or (ii). The use of multiple sources during monitoring must be consistent with routine operational practice.

(i) If a sampling tap is available where the sources are combined prior to treatment, systems must collect samples from the tap.

(ii) If a sampling tap where the sources are combined prior to treatment is not available, systems must collect samples at each source near the intake on the same day and must follow either R.61-58.10.K(4)(e)(ii)(A) or (B) for sample analysis.

(A) Systems may composite samples from each source into one sample prior to analysis. The volume of sample from each source must be weighted according to the proportion of flow from each source in the total plant flow at the time the sample is collected.

(B) Systems may analyze samples from each source separately and calculate a weighted average of the analysis results for each sampling date. The weighted average must be calculated by multiplying the analysis result for each source by the fraction that each source

contributed to total plant flow at the time the sample was collected and then summing these values.

(f) Additional Requirements.

Systems must submit a description of their sampling location(s) to the Department at the same time as the sampling schedule required under R.61-58.10.K(3). This description must address the position of the sampling location in relation to the system's water source(s) and treatment processes, including pretreatment, points of chemical treatment, and filter backwash recycle. If the Department does not respond to a system regarding sampling location(s), the system must sample at the submitted location(s).

(5) Analytical Methods.

(a) Cryptosporidium. Systems must analyze for Cryptosporidium using EPA-approved methods listed in 40 CFR 141.704.

(i) Systems must analyze at least a 10 L sample or a packed pellet volume of at least 2 mL. Systems unable to process a 10 L sample must analyze as much sample volume as can be filtered by two filters approved by EPA, up to a packed pellet volume of at least 2 mL.

(ii) (A) Matrix spike (MS) samples, must be spiked and filtered by a laboratory approved for Cryptosporidium analysis under R.61-58.10.K(6).

(B) If the volume of the matrix spike sample is greater than 10 L, the system may filter all but 10 L of the matrix spike sample in the field, and ship the filtered sample and the remaining 10 L of source water to the laboratory. In this case, the laboratory must spike the remaining 10 L of water and filter it through the filter used to collect the balance of the sample in the field.

(iii) Flow cytometer-counted spiking suspensions must be used for matrix spike samples and ongoing precision and recovery (OPR) samples.

(b) E. coli. Systems must use methods for enumeration of E. coli in source water approved in 40 CFR 136.3(a).

(i) The time from sample collection to initiation of analysis may not exceed 30 hours unless the system meets the condition of R.61-58.10.K(5)(b)(ii).

(ii) The Department may approve on a case-by-case basis the holding of an E. coli sample for up to 48 hours between sample collection and initiation of analysis if the Department determines that analyzing an E. coli sample within 30 hours is not feasible. E. coli samples held between 30 to 48 hours must be analyzed by the Colilert reagent version of Standard Methods 9223B as listed in 40 CFR 136.3(a).

(iii) Samples must be maintained between 0 degrees Celsius and 10 degrees Celsius during storage and transit to the laboratory.

(c) Turbidity. Systems must use methods for turbidity measurement approved in 40 CFR 141.74(a)(1).

(6) Approved Laboratories

(a) Cryptosporidium. Systems must have Cryptosporidium samples analyzed by a laboratory that is approved under EPA's Laboratory Quality Assurance Evaluation Program for Analysis of Cryptosporidium in Water or a laboratory that has been certified for Cryptosporidium analysis by the Department's laboratory certification program.

(b) E. coli. E. coli analyses for compliance with R.61-58.10.K must be performed by a certified laboratory.

(c) Turbidity. Measurements of turbidity must be made by a party approved by the Department.

(7) Reporting Source Water Monitoring Results.

(a) Systems must report results from the source water monitoring required under R.61-58.10.K(2) no later than 10 days after the end of the first month following the month when the sample is collected.

(b) Electronic Reporting for Systems Serving at Least 10,000 People.

- (i) All systems serving at least 10,000 people must report the results from the initial source water monitoring required under R.61-58.10.K(2)(a) to EPA electronically.
 - (ii) If a system serving at least 10,000 people is unable to report monitoring results electronically, the system may use an alternative approach for reporting monitoring results that EPA approves.
 - (c) Systems serving fewer than 10,000 people must report results from the initial source water monitoring required under R.61-58.10.K(2)(a) to the Department.
 - (d) All systems must report results from the second round of source water monitoring required under R.61-58.10.K(2)(b) to the Department.
 - (e) Systems must report the applicable information in R.61-58.10.K(7)(e)(i) and (ii) for the source water monitoring required under R.61-58.10.K(2).
 - (i) Systems must report the following data elements for Cryptosporidium analysis: PWS ID, Facility ID, Sample collection date, Sample type (field or matrix spike), Sample volume filtered (to nearest one quarter of a L), Whether or not 100 percent of the filtered volume was examined, and the Number of oocysts counted.
 - (A) For matrix spike samples, systems must also report the sample volume spiked and estimated number of oocysts spiked. These data are not required for field samples.
 - (B) For samples in which less than 10 L is filtered or less than 100 percent of the sample volume is examined, systems must also report the number of filters used and the packed pellet volume.
 - (C) For samples in which less than 100 percent of sample volume is examined, systems must also report the volume of resuspended concentrate and volume of this resuspension processed through immunomagnetic separation.
 - (ii) Systems must report the following data elements for each E. coli analysis: PWS ID, Facility ID, Sample collection date, Analytical method number, Method type, Source type (flowing stream, lake or reservoir, GWUDI), E. coli per 100 mL, and Turbidity. Systems serving fewer than 10,000 people that are not required to monitor for turbidity under R.61-58.10.K(2) are not required to report turbidity with their E. coli results.
- (8) Grandfathering Previously Collected Data.
- (a) Sample Requirements.
 - (i) Systems may comply with the initial source water monitoring requirements of R.61-58.10.K(2)(a) by grandfathering sample results collected before the system is required to begin monitoring (i.e., previously collected data). To be grandfathered, the sample results and analysis must meet the criteria in R.61-58.10.K(8) and be approved by the Department.
 - (ii) A filtered system may grandfather Cryptosporidium samples to meet the requirements of R.61-58.10.K(2)(a) when the system does not have corresponding E. coli and turbidity samples. A system that grandfathers Cryptosporidium samples without E. coli and turbidity samples is not required to collect E. coli and turbidity samples when the system completes the requirements for Cryptosporidium monitoring under R.61-58.10.K(2)(a).
 - (b) E. coli sample analysis. The analysis of E. coli samples must meet the analytical method and approved laboratory requirements of R.61-58.10.K(5) and R.61-58.10.K(6).
 - (c) Cryptosporidium sample analysis. Cryptosporidium samples must be analyzed as outlined in 40 CFR 141.707(c).
 - (d) Sampling Location. The sampling location must meet the conditions in R.61-58.10.K(4).
 - (e) Sampling Frequency.

Cryptosporidium samples must have been collected no less frequently than each calendar month on a regular schedule, beginning no earlier than January 1999. Sample collection intervals may vary for the conditions specified in R.61-58.10.K(3)(b)(i) and (ii) if the system provides documentation of the condition when reporting monitoring results.

 - (i) The Department may approve grandfathering of previously collected data where there are time gaps in the sampling frequency if the system conducts Department-specified additional

monitoring to ensure that the data used to comply with R.61-58.10.K(2)(a) are seasonally representative and unbiased.

(ii) Systems may grandfather previously collected data where the sampling frequency within each month varied. If the Cryptosporidium sampling frequency varied, systems must follow the monthly averaging procedure in R.61-58.10.K(11)(b)(v) or R.61-58.10.K(13)(a)(iii), as applicable, when calculating the bin classification for filtered systems or the mean Cryptosporidium concentration for unfiltered systems.

(f) Reporting Monitoring Results for Grandfathering.

Systems that request to grandfather previously collected monitoring results must report the following information specified in R.61-58.10.K(8)(f)(i) and (ii) by the applicable dates listed. Systems serving at least 10,000 people must report this information to EPA unless the Department approves reporting directly to the Department rather than EPA. Systems serving fewer than 10,000 people must report this information to the Department.

(i) Systems must report that they intend to submit previously collected monitoring results for grandfathering. This report must specify the number of previously collected results the system will submit, the dates of the first and last sample, and whether a system will conduct additional source water monitoring to meet the requirements of R.61-58.10.K(2)(a). Systems must report this information no later than the date the sampling schedule found in R.61-58.10.K(3) is required.

(ii) Systems must report previously collected monitoring results for grandfathering, along with the associated documentation listed in R.61-58.10.K(8)(f)(ii)(A) through (D), no later than two months after the applicable date listed in R.61-58.10.K(2)(c).

(A) For each sample result, systems must report the applicable data elements in R.61-58.10.K(7).

(B) Systems must certify that the reported monitoring results include all results that the system generated during the time period beginning with the first reported result and ending with the final reported result. This applies to samples that were collected from the sampling location specified for source water monitoring, not spiked, and analyzed using the laboratory's routine process for the analytical methods.

(C) Systems must certify that the samples were representative of a plant's source water(s) and the source water(s) have not changed. Systems must report a description of the sampling location(s), which must address the position of the sampling location in relation to the system's water source(s) and treatment processes, including points of chemical addition and filter backwash recycle.

(D) For Cryptosporidium samples, the laboratory or laboratories that analyzed the samples must provide a letter certifying that the quality control criteria specified in the methods listed in 40 CFR 141.707 were met for each sample batch associated with the reported results. Alternatively, the laboratory may provide bench sheets and sample examination report forms for each field, matrix spike, IPR, OPR, and method blank sample associated with the reported results.

(g) If the Department determines that a previously collected data set submitted for grandfathering was generated during source water conditions that were not normal for the system, such as a drought, the Department may disapprove the data. Alternatively, the Department may approve the previously collected data if the system reports additional source water monitoring data, as determined by the Department, to ensure that the data set used under R.61-58.10.K(11) or R.61-58.10.K(13) represents average source water conditions for the system.

(h) If a system submits previously collected data that fully meet the number of samples required for initial source water monitoring under R.61-58.10.K(2)(a) and some of the data are rejected due to not meeting the requirements of R.61-58.10.K(8), systems must conduct additional monitoring to replace rejected data on a schedule the Department approves. Systems are not required to begin this additional monitoring until two months after notification that data have been rejected and additional monitoring is necessary.

(9) Requirements When Making a Significant Change in Disinfection Practice.

(a) Following the completion of initial source water monitoring under R.61-58.10.K(2)(a), a system that plans to make a significant change to its disinfection practice, as defined in R.61-58.10.K(9)(b), must develop a disinfection profile and calculate a disinfection benchmark for *Giardia lamblia* and viruses as described in R.61-58.10.K(10). Prior to changing the disinfection practice, the system must notify the Department and must include in this notice the information listed in R.61-58.10.K(9)(a)(i) through (iii).

(i) A completed disinfection profile and disinfection benchmark for *Giardia lamblia* and viruses as described in R.61-58.10.K(10).

(ii) A description of the proposed change in disinfection practice.

(iii) An analysis of how the proposed change will affect the current level of disinfection.

(b) Significant changes to disinfection practice are defined as follows:

(i) Changes to the point of disinfection;

(ii) Changes to the disinfectant(s) used in the treatment plant;

(iii) Changes to the disinfection process; or

(iv) Any other modification identified by the Department as a significant change to disinfection practice.

(10) Developing the Disinfection Profile and Benchmark.

(a) Systems required to develop disinfection profiles under R.61-58.10.K(9) must follow the requirements of R.61-58.10.K(10). Systems must monitor at least weekly for a period of 12 consecutive months to determine the total log inactivation for *Giardia lamblia* and viruses. If systems monitor more frequently, the monitoring frequency must be evenly spaced. Systems that operate for fewer than 12 months per year must monitor weekly during the period of operation. Systems must determine log inactivation for *Giardia lamblia* through the entire plant, based on CT_{99.9} values in Tables 1.1 through 1.6, 2.1 and 3.1 of R.61-58.10.F as applicable. Systems must determine log inactivation for viruses through the entire treatment plant based on a protocol approved by the Department.

(b) Systems with a single point of disinfectant application prior to the entrance to the distribution system must conduct the monitoring in R.61-58.10(K)(10)(b)(i) through (iv). Systems with more than one point of disinfectant application must conduct the monitoring in R.61-58.10(K)(10)(b)(i) through (iv) for each disinfection segment. Systems must monitor the parameters necessary to determine the total inactivation ratio, using analytical methods in 40 CFR 141.74(a).

(i) For systems using a disinfectant other than UV, the temperature of the disinfected water must be measured at each residual concentration sampling point during peak hourly flow or at an alternative location approved by the Department.

(ii) For systems using chlorine, the pH of the disinfected water must be measured at each chlorine residual sampling point during peak hourly flow or at an alternative location approved by the Department.

(iii) The disinfectant contact time(s) (t) must be determined during peak hourly flow.

(iv) The residual disinfectant concentration(s) (C) of the water before or at the first customer and prior to each additional point of disinfectant application must be measured during peak hourly flow.

(c) In lieu of conducting new monitoring under R.61-58.10(K)(10)(b), systems may elect to meet the requirements of R.61-58.10(K)(10)(c)(i) or (ii).

(i) Systems that have at least one year of existing data that are substantially equivalent to data collected under the provisions of R.61-58.10(K)(10)(b) may use these data to develop disinfection profiles if the system has neither made a significant change to its treatment practice nor changed sources since the data were collected. Systems may develop disinfection profiles using up to three years of existing data.

(ii) Systems may use disinfection profile(s) developed under R.61-58.10.H or R.61-58.10.I in lieu of developing a new profile if the system has neither made a significant change to its treatment practice nor changed sources since the profile was developed. Systems that have not

developed a virus profile under R.61-58.10.H or R.61-58.10.I must develop a virus profile using the same monitoring data on which the Giardia lamblia profile is based.

(d) Systems must calculate the total inactivation ratio for Giardia lamblia as specified in R.61-58.10(K)(10)(d)(i) through (iii).

(i) Systems using only one point of disinfectant application may determine the total inactivation ratio for the disinfection segment based on either of the methods in R.61-58.10(K)(10)(d)(i)(A) or (B).

(A) Determine one inactivation ratio ($CT_{calc}/CT_{99.9}$) before or at the first customer during peak hourly flow.

(B) Determine successive $CT_{calc}/CT_{99.9}$ values, representing sequential inactivation ratios, between the point of disinfectant application and a point before or at the first customer during peak hourly flow. The system must calculate the total inactivation ratio by determining ($CT_{calc}/CT_{99.9}$) for each sequence and then adding the ($CT_{calc}/CT_{99.9}$) values together to determine the sum of $CT_{calc}/CT_{99.9}$.

(ii) Systems using more than one point of disinfectant application before the first customer must determine the CT value of each disinfection segment immediately prior to the next point of disinfectant application, or for the final segment, before or at the first customer, during peak hourly flow. The ($CT_{calc}/CT_{99.9}$) value of each segment and the sum of $CT_{calc}/CT_{99.9}$ must be calculated using the method in R.61-58.10.K(10)(d)(i)(B).

(iii) The system must determine the total logs of inactivation by multiplying the value calculated in R.61-58.10.K(10)(d)(i) or (ii) by 3.0.

(iv) Systems must calculate the log of inactivation for viruses using a protocol approved by the Department.

(e) Systems must use the procedures specified in R.61-58.10.K(10)(e)(i) and (ii) to calculate a disinfection benchmark.

(i) For each year of profiling data collected and calculated under R.61-58.10.K(10)(a) through (d), systems must determine the lowest mean monthly level of both Giardia lamblia and virus inactivation. Systems must determine the mean Giardia lamblia and virus inactivation for each calendar month for each year of profiling data by dividing the sum of daily or weekly Giardia lamblia and virus log inactivation by the number of values calculated for that month.

(ii) The disinfection benchmark is the lowest monthly mean value (for systems with one year of profiling data) or the mean of the lowest monthly mean values (for systems with more than one year of profiling data) of Giardia lamblia and virus log inactivation in each year of profiling data.

(11) Bin Classification for Filtered Systems.

(a) Following completion of the initial round of source water monitoring required under R.61-58.10.K(2)(a), filtered systems must calculate an initial Cryptosporidium bin concentration for each plant for which monitoring was required. Calculation of the bin concentration must use the Cryptosporidium results reported under R.61-58.10.K(2)(a) and must follow the procedures in R.61-58.10.K(11)(b)(i) through (v).

(b) Cryptosporidium bin concentrations. Bin concentration is the cryptosporidium concentration(s) used to determine bin classification

(i) For systems that collect a total of at least 48 samples, the bin concentration is equal to the arithmetic mean of all sample concentrations.

(ii) For systems that collect a total of at least 24 samples, but not more than 47 samples, the bin concentration is equal to the highest arithmetic mean of all sample concentrations in any 12 consecutive months during which Cryptosporidium samples were collected.

(iii) For systems that serve fewer than 10,000 people and monitor for Cryptosporidium for only one year (i.e., collect 24 samples in 12 months), the bin concentration is equal to the arithmetic mean of all sample concentrations.

(iv) For systems with plants operating only part of the year that monitor fewer than 12 months per year under R.61-58.10.K(2)(e), the bin concentration is equal to the highest arithmetic mean of all sample concentrations during any year of Cryptosporidium monitoring.

(v) If the monthly Cryptosporidium sampling frequency varies, systems must first calculate a monthly average for each month of monitoring. Systems must then use these monthly average concentrations, rather than individual sample concentrations, in the applicable calculation for bin classification in R.61-58.10.K(11)(b)(i) through (iv).

(c) Filtered systems that are required to monitor under R.61-58.10.K(2) must determine their initial bin classification from the Bin Classification Table that follows and using the Cryptosporidium bin concentration calculated under R.61-58.10.K(11)(a) and (b). The bin classification for filtered systems that serve fewer than 10,000 people and are not required to monitor under R.61-58.10.K(2)(a)(iv) is Bin 1.

Bin Classification Table For Filtered Systems

Cryptosporidium Concentration	Bin Classification
Less than 0.075 oocysts per L	Bin 1
0.075 to less than 1.0 oocysts per L	Bin 2
1.0 to less than 3.0 oocysts per L	Bin 3
Greater than or equal to 3.0 oocysts per L	Bin 4

(d) Following completion of the second round of source water monitoring required under R.61-58.10.K(2)(b), filtered systems must recalculate their Cryptosporidium bin concentration using the Cryptosporidium results reported under R.61-58.10.K(2)(b) and following the procedures in R.61-58.10.K(11)(b)(i) through (iv). Systems must then redetermine their bin classification using this bin concentration and the table in R.61-58.10.K(11)(c).

(e) Reporting Bin Classifications to the Department.

(i) Filtered systems must report their initial bin classification under R.61-58.10.K(11)(c) to the Department for approval no later than 6 months after the system is required to complete initial source water monitoring based on the schedule in R.61-58.10.K(2)(c).

(ii) Systems must report their bin classification under R.61-58.10.K(11)(d) to the Department for approval no later than 6 months after the system is required to complete the second round of source water monitoring based on the schedule in R.61-58.10.K(2)(c).

(iii) The bin classification report to the Department must include a summary of source water monitoring data and the calculation procedure used to determine bin classification.

(f) Failure to comply with the conditions of R.61-58.10.K(11)(e) is a violation of the treatment technique requirement.

(12) Filtered System Additional Cryptosporidium Treatment Requirements.

(a) Filtered systems must provide the level of additional treatment for Cryptosporidium specified in this paragraph (12)(a) based on their bin classification as determined under R.61-58.10.K(11) and according to the schedule in R.61-58.10.K(14).

Bin Classifications According to Treatment Type¹

Bin Classification	Conventional Filtration (includes softening)	Direct Filtration	Slow sand or diatomaceous earth filtration	Alternative filtration technologies
Bin 1	No additional treatment	No additional treatment	No additional treatment	No additional treatment
Bin 2	1-log treatment	1.5-log treatment	1-log treatment	See note 2
Bin 3	2-log treatment	2.5-log treatment	2-log treatment	See note 3
Bin 4	2.5-log treatment	3-log treatment	2.5-log treatment	See note 4

Notes:

1. The treatment requirements are valid provided that the water system is in full compliance with R.61-58.10.H & R.61-58.10.I

2. As determined by the Department such that the total Cryptosporidium removal and inactivation is at least 4.0-log.
3. As determined by the Department such that the total Cryptosporidium removal and inactivation is at least 5.0-log.
4. As determined by the Department such that the total Cryptosporidium removal and inactivation is at least 5.5-log.

(b) Cryptosporidium Treatment Requirements.

(i) Filtered systems must use one or more of the treatment and management options listed in R.61-58.10.K(16), termed the microbial toolbox, to comply with the additional Cryptosporidium treatment required in R.61-58.10.K(12)(a).

(ii) Systems classified in Bin 3 and Bin 4 must achieve at least 1-log of the additional Cryptosporidium treatment required under R.61-58.10.K(12)(a) of this section using either one or a combination of the following: bag filters, bank filtration, cartridge filters, chlorine dioxide, membranes, ozone, or UV, as described in R.61-58.10.K(17) through (21).

(c) Failure by a system in any month to achieve treatment credit by meeting criteria in R.61-58.10.K(17) through (21) for microbial toolbox options that is at least equal to the level of treatment required in R.61-58.10.K(12)(a) is a violation of the treatment technique requirement.

(d) If the Department determines during a sanitary survey or an equivalent source water assessment that after a system completed the monitoring conducted under R.61-58.10.K(2)(a) or (b), significant changes occurred in the system's watershed that could lead to increased contamination of the source water by Cryptosporidium, the system must take actions specified by the Department to address the contamination. These actions may include additional source water monitoring and/or implementing microbial toolbox options listed in R.61-58.10.K(16).

(13) Unfiltered system Cryptosporidium Treatment Requirements.

(a) Determination of Mean Cryptosporidium Level.

(i) Following completion of the initial source water monitoring required under R.61-58.10.K(2)(a), unfiltered systems must calculate the arithmetic mean of all Cryptosporidium sample concentrations reported under R.61-58.10.K(2)(a). Systems must report this value to the Department for approval no later than 6 months after the month the system is required to complete initial source water monitoring based on the schedule in R.61-58.10.K(2)(c).

(ii) Following completion of the second round of source water monitoring required under R.61-58.10.K(2)(b), unfiltered systems must calculate the arithmetic mean of all Cryptosporidium sample concentrations reported under R.61-58.10.K(2)(b). Systems must report this value to the Department for approval no later than 6 months after the month the system is required to complete the second round of source water monitoring based on the schedule in R.61-58.10.K(2)(c).

(iii) If the monthly Cryptosporidium sampling frequency varies, systems must first calculate a monthly average for each month of monitoring. Systems must then use these monthly average concentrations, rather than individual sample concentrations, in the calculation of the mean Cryptosporidium level in R.61-58.10.K(13)(a)(i) or (ii).

(iv) The report to the Department of the mean Cryptosporidium levels calculated under R.61-58.10.K(13)(a)(i) and (ii) must include a summary of the source water monitoring data used for the calculation.

(v) Failure to comply with the conditions of R.61-58.10.K(13)(a) is a violation of the treatment technique requirement.

(b) Cryptosporidium Inactivation Requirements.

Unfiltered systems must provide the level of inactivation for Cryptosporidium specified in this paragraph (b), based on their mean Cryptosporidium levels as determined under R.61-58.10.K(13)(a) and according to the schedule in R.61-58.10.K(14).

(i) Unfiltered systems with a mean Cryptosporidium level of 0.01 oocysts per L or less must provide at least 2-log Cryptosporidium inactivation.

(ii) Unfiltered systems with a mean Cryptosporidium level of greater than 0.01 oocysts per L must provide at least 3-log Cryptosporidium inactivation.

(c) Inactivation Treatment Technology Requirements.

Unfiltered systems must use chlorine dioxide, ozone, or UV as described in R.61-58.10.K(21) to meet the Cryptosporidium inactivation requirements of R.61-58.10.K(13).

(i) Systems that use chlorine dioxide or ozone and fail to achieve the Cryptosporidium inactivation required in R.61-58.10.K(13)(b) on more than one day in the calendar month are in violation of the treatment technique requirement.

(ii) Systems that use UV light and fail to achieve the Cryptosporidium inactivation required in R.61-58.10.K(13)(b) by meeting the criteria in R.61-58.10.K(21)(d)(iii)(B) are in violation of the treatment technique requirement.

(d) Use of Two Disinfectants.

Unfiltered systems must meet the combined Cryptosporidium inactivation requirements of R.61-58.10.K(13) and Giardia lamblia and virus inactivation requirements of R.61-58.10.D(1) using a minimum of two disinfectants, and each of two disinfectants must separately achieve the total inactivation required for either Cryptosporidium, Giardia lamblia, or viruses.

(14) Schedule for compliance with Cryptosporidium Treatment Requirements.

(a) Following initial bin classification under R.61-58.10.K(11)(c), filtered systems must provide the level of treatment for Cryptosporidium required under R.61-58.10.K(12) according to the schedule in R.61-58.10.K(14)(c).

(b) Following initial determination of the mean Cryptosporidium level under R.61-58.10.K(13)(a)(i), unfiltered systems must provide the level of treatment for Cryptosporidium required under R.61-58.10.K(13) according to the schedule in R.61-58.10.K(14)(c).

(c) Cryptosporidium treatment compliance dates.

(i) Systems that serve at least 100,000 people must comply with Cryptosporidium treatment requirements no later than April 1, 2012.

(ii) Systems that serve from 50,000 to 99,999 people must comply with Cryptosporidium treatment requirements no later than October 1, 2012.

(iii) Systems that serve from 10,000 to 49,999 people must comply with Cryptosporidium treatment requirements no later than October 1, 2013.

(iv) Systems that serve fewer than 10,000 people must comply with Cryptosporidium treatment requirements no later than October 1, 2014.

(v) The Department may grant an additional two years for complying with the treatment technique requirements for systems making capital improvements.

(d) If the bin classification for a filtered system changes following the second round of source water monitoring, as determined under R.61-58.10.K(11)(d), the system must provide the level of treatment for Cryptosporidium required under R.61-58.10.K(12) on a schedule the Department approves.

(e) If the mean Cryptosporidium level for an unfiltered system changes following the second round of monitoring, as determined under R.61-58.10.K(13)(a)(ii), and if the system must provide a different level of Cryptosporidium treatment under R.61-58.10.K(13) due to this change, the system must meet this treatment requirement on a schedule the Department approves.

(15) Requirements for uncovered finished water storage facilities.

(a) Systems using uncovered finished water storage facilities must comply with the conditions of R.61-58.10.K(15).

(b) Systems must notify the Department of the use of each uncovered finished water storage facility no later than April 1, 2008.

(c) Systems must meet the conditions of R.61-58.10.K(15)(c)(i) or (ii) for each uncovered finished water storage facility or be in compliance with a Department-approved schedule to meet these conditions no later than April 1, 2009.

- (i) Systems must cover any uncovered finished water storage facility.
- (ii) Systems must treat the discharge from the uncovered finished water storage facility to the distribution system to achieve inactivation and/or removal of at least 4-log virus, 3-log *Giardia lamblia*, and 2-log *Cryptosporidium* using a protocol approved by the Department.
- (d) Failure to comply with the requirements of R.61-58.10.K(15) is a violation of the treatment technique requirement.

(16) Microbial toolbox options for meeting *Cryptosporidium* treatment requirements.

(a) *Cryptosporidium* Treatment Credits.

(i) Systems may receive the treatment credits listed in R.61-58.10.K(16)(b) by meeting the conditions for microbial toolbox options described in R.61-58.10.K(17) through (21). Systems apply these treatment credits to meet the treatment requirements in R.61-58.10(K)(12) or R.61-58.10(K)(13), as applicable.

(ii) Unfiltered systems are eligible for treatment credits for the microbial toolbox options described in R.61-58.10.K(21) only.

(b) Microbial Toolbox Summary Treatment Credits and Criteria

(i) Source Protection and Management Toolbox Options

(A) Watershed control program: 0.5-log credit may be given for Department-approved programs that include the required elements, annual program status report to the Department, and regular watershed surveys. Unfiltered systems are not eligible for this credit. Specific criteria for obtaining and maintaining this credit are detailed in R.61-58.10.K(17)(a).

(B) Alternative source or intake management: No prescribed credit is given. Systems may conduct simultaneous monitoring for treatment bin classification at alternative intake locations or under alternative intake management strategies. Specific criteria for this credit are detailed in R.61-58.10.K(17)(b).

(ii) Pre Filtration Toolbox Options

(A) Presedimentation basin with coagulation: 0.5-log credit may be given during any month that presedimentation basins achieve a monthly mean reduction of 0.5-log or greater in turbidity or alternative Department-approved performance criteria. To be eligible, basins must be operated continuously with coagulant addition and all plant flow must pass through the basins. Specific criteria for obtaining and maintaining this credit are detailed in R.61-58.10.K(18)(a).

(B) Two-stage lime softening: 0.5-log credit for two-stage softening may be given where chemical addition and hardness precipitation occur in both stages. All plant flow must pass through both stages. Single stage softening is credited as equivalent to conventional treatment. Specific criteria for obtaining and maintaining this credit are detailed in R.61-58.10.K(18)(b).

(C) Bank filtration: 0.5-log credit may be given for a 25-foot setback; 1.0-log credit may be given for a 50-foot setback. The aquifer must be unconsolidated sand consisting of at least 10 percent fines. The average turbidity in the wells must be less than 1 NTU. Systems using wells followed by filtration when conducting source water monitoring must sample the well to determine bin classification and are not eligible for additional credit. Specific criteria for obtaining and maintaining this credit are detailed in R.61-58.10.K(18)(c).

(iii) Treatment Performance Toolbox Options

(A) Combined filter performance: 0.5-log credit may be given for combined filter effluent turbidity less than or equal to 0.15 NTU in at least 95 percent of measurements each month. Specific criteria for obtaining and maintaining this credit are detailed in R.61-58.10.K(19)(a).

(B) Individual filter performance: 0.5-log credit (in addition to 0.5-log combined filter performance credit) may be given if individual filter effluent turbidity is less than or equal to 0.15 NTU in at least 95 percent of samples each month in each filter and is never greater than 0.3 NTU in two consecutive measurements in any filter. Specific criteria for obtaining and maintaining this credit are detailed in R.61-58.10.K(19)(b).

(C) Demonstration of performance: Credit may be given to unit processes or treatment trains based on a demonstration to the Department with a Department-approved protocol. Specific criteria for obtaining and maintaining this credit are detailed in R.61-58.10.K(19)(c).

(iv) Additional Filtration Toolbox Options

(A) Bag or cartridge filters (individual filters): Up to 2-log credit may be given based on the removal efficiency demonstrated during challenge testing with a 1.0-log factor of safety. Specific criteria for obtaining and maintaining this credit are detailed in R.61-58.10.K(20)(a).

(B) Bag or cartridge filters (in series): Up to 2.5-log credit may be given based on the removal efficiency demonstrated during challenge testing with a 0.5-log factor of safety. Specific criteria for obtaining and maintaining this credit are detailed in R.61-58.10.K(20)(a).

(C) Membrane filtration: The log credit that may be given is equal to the removal efficiency demonstrated in challenge testing for a specific device if supported by direct integrity testing. Specific criteria for obtaining and maintaining this credit are detailed in R.61-58.10.K(20)(b).

(D) Second stage filtration: 0.5-log credit may be given for a second separate granular media filtration stage if the treatment train includes coagulation prior to the first filter. Specific criteria for obtaining and maintaining this credit are detailed in R.61-58.10.K(20)(c).

(E) Slow sand filters: 2.5-log credit may be given if it is a secondary filtration step. 3.0-log credit may be given if it is a primary filtration process. Neither option can include chlorination before the filters. Specific criteria for obtaining and maintaining this credit are detailed in R.61-58.10.K(20)(d).

(v) Inactivation Toolbox Options

(A) Chlorine dioxide: Log credit given is based on the measured CT in relation to the CT table. Specific criteria for obtaining and maintaining this credit are detailed in R.61-58.10.K(21)(b).

(B) Ozone: Log credit given is based on the measured CT in relation to the CT table. Specific criteria for obtaining and maintaining this credit are detailed in R.61-58.10.K(21)(b).

(C) UV: Log credit given is based on validated UV dose in relation to UV dose table. Reactor validation testing is required to establish UV dose and associated operating conditions. Specific criteria for obtaining and maintaining this credit are detailed in R.61-58.10.K(21)(d).

(17) Source Toolbox Components.

(a) Watershed Control Program.

Systems receive 0.5-log *Cryptosporidium* treatment credit for implementing a watershed control program that meets the following requirements:

(i) Systems that intend to apply for the watershed control program credit must notify the Department of this intent no later than two years prior to the treatment compliance date applicable to the system in R.61-58.10.K(14).

(ii) Systems must submit to the Department a proposed watershed control plan no later than one year before the applicable treatment compliance date in R.61-58.10.K(14). The Department must approve the watershed control plan for the system to receive treatment credit. The watershed control plan must include the elements in R.61-58.10.K(17)(a)(ii)(A) through (D).

(A) Identification of an “area of influence” outside of which the likelihood of *Cryptosporidium* or fecal contamination affecting the treatment plant intake is not significant. This is the area to be evaluated in future watershed surveys under R.61-58.10.K(17)(a)(v)(B).

(B) Identification of both potential and actual sources of *Cryptosporidium* contamination and an assessment of the relative impact of these sources on the system’s source water quality.

(C) An analysis of the effectiveness and feasibility of control measures that could reduce *Cryptosporidium* loading from sources of contamination to the system’s source water.

(D) A statement of goals and specific actions the system will undertake to reduce source water *Cryptosporidium* levels. The plan must explain how the actions are expected to contribute to specific goals, identify watershed partners and their roles, identify resource

requirements and commitments, and include a schedule for plan implementation with deadlines for completing specific actions identified in the plan.

(iii) Systems with existing watershed control programs (i.e., programs in place on January 5, 2006) are eligible to seek this credit. Their watershed control plans must meet the criteria in R.61-58.10.K(17)(a)(ii) and must specify ongoing and future actions that will reduce source water *Cryptosporidium* levels.

(iv) If the Department does not respond to a system regarding approval of a watershed control plan submitted under R.61-58.10.K(17) and the system meets the other requirements of R.61-58.10.K(17), the watershed control program will be considered approved and 0.5 log *Cryptosporidium* treatment credit will be awarded unless and until the Department subsequently withdraws such approval.

(v) Systems must complete the actions in R.61-58.10.K(17)(a)(v)(A) through (C) to maintain the 0.5-log credit.

(A) Submit an annual watershed control program status report to the Department. The annual watershed control program status report must describe the system's implementation of the approved plan and assess the adequacy of the plan to meet its goals. It must explain how the system is addressing any shortcomings in plan implementation, including those previously identified by the Department or as the result of the watershed survey conducted under R.61-58.10.K(17)(a)(v)(B). The report must also describe any significant changes that have occurred in the watershed since the last watershed sanitary survey. If a system determines during implementation that making a significant change to its approved watershed control program is necessary, the system must notify the Department prior to making any such changes. If any change is likely to reduce the level of source water protection, the system must also list in its notification the actions the system will take to mitigate this effect.

(B) Undergo a watershed sanitary survey every three years for community water systems and every five years for non-community water systems and submit the survey report to the Department. The survey must be conducted according to Department guidelines and by persons approved by the Department.

(1) The watershed sanitary survey must meet the following criteria: encompass the region identified in the Department-approved watershed control plan as the area of influence; assess the implementation of actions to reduce source water *Cryptosporidium* levels; and identify any significant new sources of *Cryptosporidium*.

(2) If the Department determines that significant changes may have occurred in the watershed since the previous watershed sanitary survey, systems must undergo another watershed sanitary survey by a date the Department requires, which may be earlier than the regular date in R.61-58.10.K(17)(a)(v)(B).

(C) The system must make the watershed control plan, annual status reports, and watershed sanitary survey reports available to the public upon request. These documents must be in a plain language style and include criteria by which to evaluate the success of the program in achieving plan goals. The Department may approve systems to withhold from the public portions of the annual status report, watershed control plan, and watershed sanitary survey based on water supply security considerations.

(vi) If the Department determines that a system is not carrying out the approved watershed control plan, the Department may withdraw the watershed control program treatment credit.

(b) Alternative Source.

(i) A system may conduct source water monitoring that reflects a different intake location (either in the same source or for an alternate source) or a different procedure for the timing or level of withdrawal from the source (alternative source monitoring). If the Department approves, a system may determine its bin classification under R.61-58.10.K(11) based on the alternative source monitoring results.

(ii) If systems conduct alternative source monitoring under R.61-58.10.K(17)(b)(i), systems must also monitor their current plant intake concurrently as described in R.61-58.10.K(2).

(iii) Alternative source monitoring under R.61-58.10.K(17)(b)(i) must meet the requirements for source monitoring to determine bin classification, as described in R.61-58.10.K(2) through (7). Systems must report the alternative source monitoring results to the Department, along with supporting information documenting the operating conditions under which the samples were collected.

(iv) If a system determines its bin classification under R.61-58.10.K(11) using alternative source monitoring results that reflect a different intake location or a different procedure for managing the timing or level of withdrawal from the source, the system must relocate the intake or permanently adopt the withdrawal procedure, as applicable, no later than the applicable treatment compliance date in R.61-58.10.K(14).

(18) Pre-filtration Treatment Toolbox Components.

(a) Presedimentation.

Systems receive 0.5-log Cryptosporidium treatment credit for a presedimentation basin during any month the process meets the criteria in R.61-58.10.K(18)(a).

(i) The presedimentation basin must be in continuous operation and must treat the entire plant flow taken from a surface water or GWUDI source.

(ii) The system must continuously add a coagulant to the presedimentation basin.

(iii) The presedimentation basin must achieve the performance criteria in R.61-58.10.K(18)(iii)(A) or (B).

(A) The system must demonstrate at least 0.5-log mean reduction of influent turbidity. This reduction must be determined using daily turbidity measurements in the presedimentation process influent and effluent and must be calculated as follows: $\log_{10}(\text{monthly mean of daily influent turbidity}) - \log_{10}(\text{monthly mean of daily effluent turbidity})$.

(B) The system must comply with Department-approved performance criteria that demonstrate at least 0.5-log mean removal of micron-sized particulate material through the presedimentation process.

(b) Two-stage Lime Softening.

Systems receive an additional 0.5-log Cryptosporidium treatment credit for a two-stage lime softening plant if chemical addition and hardness precipitation occur in two separate and sequential softening stages prior to filtration. Both softening stages must treat the entire plant flow taken from a surface water or GWUDI source.

(c) Bank Filtration.

Systems receive Cryptosporidium treatment credit for bank filtration that serves as pretreatment to a filtration plant by meeting the criteria in R.61-58.10.K(18)(c). Systems using bank filtration when they begin source water monitoring under R.61-58.10.K(2)(a) must collect samples as described in R.61-58.10.K(4)(d) and are not eligible for this credit.

(i) Wells with a ground water flow path of at least 25 feet receive 0.5-log treatment credit; wells with a ground water flow path of at least 50 feet receive 1.0-log treatment credit. The ground water flow path must be determined as specified in R.61-58.10.K(18)(c)(iv).

(ii) Only wells in granular aquifers are eligible for treatment credit. Granular aquifers are those comprised of sand, clay, silt, rock fragments, pebbles or larger particles, and minor cement. A system must characterize the aquifer at the well site to determine aquifer properties. Systems must extract a core from the aquifer and demonstrate that in at least 90 percent of the core length, grains less than 1.0 mm in diameter constitute at least 10 percent of the core material.

(iii) Only horizontal and vertical wells are eligible for treatment credit.

(iv) For vertical wells, the ground water flow path is the measured distance from the edge of the surface water body under high flow conditions (determined by the 100 year floodplain elevation boundary or by the floodway, as defined in Federal Emergency Management Agency flood hazard maps) to the well screen. For horizontal wells, the ground water flow path is the measured distance from the bed of the river under normal flow conditions to the closest horizontal well lateral screen.

(v) Systems must monitor each wellhead for turbidity at least once every four hours while the bank filtration process is in operation. If monthly average turbidity levels, based on daily maximum values in the well, exceed 1 NTU, the system must report this result to the Department and conduct an assessment within 30 days to determine the cause of the high turbidity levels in the well. If the Department determines that microbial removal has been compromised, the Department may revoke treatment credit until the system implements corrective actions approved by the Department to remediate the problem.

(vi) Springs and infiltration galleries are not eligible for treatment credit under R.61-58.10.K(18), but are eligible for credit under R.61-58.10.K(19)(c).

(vii) Bank Filtration Demonstration of Performance.

The Department may approve Cryptosporidium treatment credit for bank filtration based on a demonstration of performance study that meets the criteria in this paragraph. This treatment credit may be greater than 1.0-log and may be awarded to bank filtration that does not meet the criteria in R.61-58.10.K(18)(c)(i) through (v).

(A) The study must follow a Department-approved protocol and must involve the collection of data on the removal of Cryptosporidium or a surrogate for Cryptosporidium and related hydrogeologic and water quality parameters during the full range of operating conditions.

(B) The study must include sampling both from the production well(s) and from monitoring wells that are screened and located along the shortest flow path between the surface water source and the production well(s).

(19) Treatment Performance Toolbox Components.

(a) Combined Filter Performance.

Systems using conventional filtration treatment or direct filtration treatment may receive an additional 0.5-log Cryptosporidium treatment credit during any month the system meets the criteria in this paragraph. Combined filter effluent (CFE) turbidity must be less than or equal to 0.15 NTU in at least 95 percent of the measurements. Turbidity must be measured as described in 40 CFR 141.74(a) and (c).

(b) Individual Filter Performance.

Systems using conventional filtration treatment or direct filtration treatment may receive 0.5-log Cryptosporidium treatment credit, which can be in addition to the 0.5-log credit under R.61-58.10.K(19)(a), during any month the system meets the criteria in this paragraph (b). Compliance with these criteria must be based on individual filter turbidity monitoring as described in R.61-58.10.H(5) or R.61-58.10.I(7), as applicable.

(i) The filtered water turbidity for each individual filter must be less than or equal to 0.15 NTU in at least 95 percent of the measurements recorded each month.

(ii) No individual filter may have a measured turbidity greater than 0.3 NTU in two consecutive measurements taken 15 minutes apart.

(iii) Any system that has received treatment credit for individual filter performance and fails to meet the requirements of R.61-58.10.K(19)(b)(i) or (ii) during any month does not receive a treatment technique violation under R.61-58.10.K(12)(c) if the Department determines the following:

(A) The failure was due to unusual and short-term circumstances that could not reasonably be prevented through optimizing treatment plant design, operation, and maintenance.

(B) The system has experienced no more than two such failures in any calendar year.

(c) Demonstration of Performance.

The Department may approve Cryptosporidium treatment credit for drinking water treatment processes based on a demonstration of performance study that meets the criteria in this paragraph (c). This treatment credit may be greater than or less than the prescribed treatment credits in R.61-58.10.K(12) or R.61-58.10.K(18) through (21) and may be awarded to treatment processes that do not meet the criteria for the prescribed credits.

(i) Systems cannot receive the prescribed treatment credit for any toolbox option in R.61-58.10.K(18) through R.61-58.10.K(21) if that toolbox option is included in a demonstration of performance study for which treatment credit is awarded under this paragraph.

(ii) The demonstration of performance study must follow a Department-approved protocol and must demonstrate the level of Cryptosporidium reduction the treatment process will achieve under the full range of expected operating conditions for the system.

(iii) Approval by the Department must be in writing and may include monitoring and treatment performance criteria that the system must demonstrate and report on an ongoing basis to remain eligible for the treatment credit. The Department may designate such criteria where necessary to verify that the conditions under which the demonstration of performance credit was approved are maintained during routine operation.

(20) Additional Filtration Toolbox Components.

(a) Bag and Cartridge Filters.

With Department approval, systems may receive Cryptosporidium treatment credit of up to 2.0-log for individual bag or cartridge filters and up to 2.5-log for bag or cartridge filters operated in series by meeting the criteria in R.61-58.10.K(20)(a)(i) through (x). To be eligible for this credit, systems must report the results of challenge testing that meets the requirements of R.61-58.10.K(20)(a)(ii) through (ix) to the Department. The filters must treat the entire plant flow taken from a subpart H source.

(i) The Cryptosporidium treatment credit awarded to bag or cartridge filters must be based on the removal efficiency demonstrated during challenge testing that is conducted according to the criteria in R.61-58.10.K(20)(a)(ii) through (ix). A factor of safety equal to 1-log for individual bag or cartridge filters and 0.5-log for bag or cartridge filters in series must be applied to challenge testing results to determine removal credit. Systems may use results from challenge testing conducted prior to January 5, 2006 if the prior testing was consistent with the criteria specified in R.61-58.10.K(20)(a)(ii) through (ix).

(ii) Challenge testing must be performed on full-scale bag or cartridge filters, and the associated filter housing or pressure vessel, that are identical in material and construction to the filters and housings the system will use for removal of Cryptosporidium. Bag or cartridge filters must be challenge tested in the same configuration that the system will use, either as individual filters or as a series configuration of filters.

(iii) Challenge testing must be conducted using Cryptosporidium or a surrogate that is removed no more efficiently than Cryptosporidium. The microorganism or surrogate used during challenge testing is referred to as the challenge particulate. The concentration of the challenge particulate must be determined using a method capable of discreetly quantifying the specific microorganism or surrogate used in the test; gross measurements such as turbidity may not be used.

(iv) The maximum feed water concentration that can be used during a challenge test must be based on the detection limit of the challenge particulate in the filtrate (i.e., filtrate detection limit) and must be calculated using the following equation:

$$\text{Maximum Feed Concentration} = 10,000 \times (\text{Filtrate Detection Limit})$$

(v) Challenge testing must be conducted at the maximum design flow rate for the filter as specified by the manufacturer.

(vi) Each filter evaluated must be tested for a duration sufficient to reach 100 percent of the terminal pressure drop. This maximum pressure drop is the pressure drop under which the filter may be used to comply with the requirements of R.61-58.10(K).

(vii) Removal efficiency of a filter must be determined from the results of the challenge test and expressed in terms of log removal values using the following equation:

$$\text{LRV} = \text{LOG}_{10}(C_f) - \text{LOG}_{10}(C_p)$$

Where: LRV = log removal value demonstrated during challenge testing; C_f = the feed concentration measured during the challenge test; and C_p = the filtrate concentration measured during the challenge test. In applying this equation, the same units must be used

for the feed and filtrate concentrations. If the challenge particulate is not detected in the filtrate, then the term C_p must be set equal to the detection limit.

(viii) Each filter tested must be challenged with the challenge particulate during three periods over the filtration cycle: within two hours of start-up of a new filter; when the pressure drop is between 45 and 55 percent of the terminal pressure drop; and at the end of the cycle after the pressure drop has reached 100 percent of the terminal pressure drop. A log removal value must be calculated for each of these challenge periods for each filter tested. The log removal value for the filter must be assigned the value of the minimum log removal value observed during the three challenge periods for that filter.

(ix) If fewer than 20 filters are tested, the overall removal efficiency for the filter product line must be set equal to the lowest filter log removal value among the filters tested. If 20 or more filters are tested, the overall removal efficiency for the filter product line must be set equal to the 10th percentile of the set of filter log removal values for the various filters tested. The percentile is defined by $(i/(n+1))$ where i is the rank of n individual data points ordered lowest to highest. If necessary, the 10th percentile may be calculated using linear interpolation.

(x) If a previously tested filter is modified in a manner that could change the removal efficiency of the filter product line, challenge testing to demonstrate the removal efficiency of the modified filter must be conducted and submitted to the Department.

(b) Membrane Filtration.

(i) Systems may receive Cryptosporidium treatment credit for membrane filtration that meets the criteria of this paragraph (b). Membrane cartridge filters that meet the definition of membrane filtration in R.61-58.B are eligible for this credit. The level of treatment credit a system receives is equal to the lower of the values determined under R.61-58.10.K(20)(b)(i)(A) and (B).

(A) The removal efficiency demonstrated during challenge testing conducted under the conditions in R.61-58.10.K(20)(b)(ii).

(B) The maximum removal efficiency that can be verified through direct integrity testing used with the membrane filtration process under the conditions in R.61-58.10.K(20)(b)(iii).

(ii) Challenge Testing. The membrane used by the system must undergo challenge testing to evaluate removal efficiency, and the system must report the results of challenge testing to the Department. Challenge testing must be conducted according to the criteria in R.61-58.10.K(20)(b)(ii)(A) through (G). Systems may use data from challenge testing conducted prior to January 5, 2006 if the prior testing was consistent with the criteria in R.61-58.10.K(20)(b)(ii)(A) through (G).

(A) Challenge testing must be conducted on either a full-scale membrane module, identical in material and construction to the membrane modules used in the system's treatment facility, or a smaller-scale membrane module, identical in material and similar in construction to the full-scale module. A module is defined as the smallest component of a membrane unit in which a specific membrane surface area is housed in a device with a filtrate outlet structure.

(B) Challenge testing must be conducted using Cryptosporidium oocysts or a surrogate that is removed no more efficiently than Cryptosporidium oocysts. The organism or surrogate used during challenge testing is referred to as the challenge particulate. The concentration of the challenge particulate, in both the feed and filtrate water, must be determined using a method capable of discretely quantifying the specific challenge particulate used in the test; gross measurements such as turbidity may not be used.

(C) The maximum feed water concentration that can be used during a challenge test is based on the detection limit of the challenge particulate in the filtrate and must be determined according to the following equation:

$$\text{Maximum Feed Concentration} = 3,160,000 \times (\text{Filtrate Detection Limit})$$

(D) Challenge testing must be conducted under representative hydraulic conditions at the maximum design flux and maximum design process recovery specified by the manufacturer for the membrane module. Flux is defined as the throughput of a pressure driven membrane process expressed as flow per unit of membrane area. Recovery is defined as the

volumetric percent of feed water that is converted to filtrate over the course of an operating cycle uninterrupted by events such as chemical cleaning or a solids removal process (i.e., backwashing).

(E) Removal efficiency of a membrane module must be calculated from the challenge test results and expressed as a log removal value according to the following equation:

$$\text{LRV} = \text{LOG}_{10}(\text{C}_f) - \text{LOG}_{10}(\text{C}_p)$$

Where: LRV = log removal value demonstrated during the challenge test; C_f = the feed concentration measured during the challenge test; and C_p = the filtrate concentration measured during the challenge test. Equivalent units must be used for the feed and filtrate concentrations. If the challenge particulate is not detected in the filtrate, the term C_p is set equal to the detection limit for the purpose of calculating the log removal value. A log removal value must be calculated for each membrane module evaluated during the challenge test.

(F) The removal efficiency of a membrane filtration process demonstrated during challenge testing must be expressed as a log removal value. If fewer than 20 modules are tested, then the challenge test log removal value is equal to the lowest of the representative log removal values among the modules tested. If 20 or more modules are tested, then the challenge test log removal value is equal to the 10th percentile of the representative log removal values among the modules tested. The percentile is defined by $(i/(n+1))$ where i is the rank of n individual data points ordered lowest to highest. If necessary, the 10th percentile may be calculated using linear interpolation.

(G) The challenge test must establish a quality control release value for a non-destructive performance test that demonstrates the Cryptosporidium removal capability of the membrane filtration module. This performance test must be applied to each production membrane module used by the system that was not directly challenge tested in order to verify Cryptosporidium removal capability. Production modules that do not meet the established quality control release value are not eligible for the treatment credit demonstrated during the challenge test.

(H) If a previously tested membrane is modified in a manner that could change the removal efficiency of the membrane or the applicability of the non-destructive performance test and associated quality control release value, additional challenge testing to demonstrate a new removal efficiency and quality control release value must be conducted and submitted to the Department.

(iii) Direct integrity testing. Systems must conduct direct integrity testing in a manner that demonstrates a removal efficiency equal to or greater than the removal credit awarded to the membrane filtration process and meets the requirements described in R.61-58.10.K(20)(b)(iii)(A) through (F). A direct integrity test is defined as a physical test applied to a membrane unit in order to identify and isolate integrity breaches (i.e., one or more leaks that could result in contamination of the filtrate).

(A) The direct integrity test must be independently applied to each membrane unit in service. A membrane unit is defined as a group of membrane modules that share common valving that allows the unit to be isolated from the rest of the system for the purpose of integrity testing or other maintenance.

(B) The direct integrity method must have a resolution of 3 micrometers or less, where resolution is defined as the size of the smallest integrity breach that contributes to a response from the direct integrity test.

(C) The direct integrity test must have a sensitivity sufficient to verify the log treatment credit awarded to the membrane filtration process by the Department, where sensitivity is defined as the maximum log removal value that can be reliably verified by a direct integrity test. Sensitivity must be determined using the approach in either R.61-58.10.K(20)(b)(iii)(C)(1) or (2) as applicable to the type of direct integrity test the system uses.

(1) For direct integrity tests that use an applied pressure or vacuum, the direct integrity test sensitivity must be calculated according to the following equation:

$$LRV_{DIT} = \text{LOG}_{10} (Q_p / (\text{VCF} \times Q_{\text{breach}}))$$

Where: LRV_{DIT} = the sensitivity of the direct integrity test; Q_p = total design filtrate flow from the membrane unit; Q_{breach} = flow of water from an integrity breach associated with the smallest integrity test response that can be reliably measured, and VCF = volumetric concentration factor. The volumetric concentration factor is the ratio of the suspended solids concentration on the high pressure side of the membrane relative to that in the feed water.

(2) For direct integrity tests that use a particulate or molecular marker, the direct integrity test sensitivity must be calculated according to the following equation:

$$LRV_{DIT} = \text{LOG}_{10}(C_f) - \text{LOG}_{10}(C_p)$$

Where: LRV_{DIT} = the sensitivity of the direct integrity test; C_f = the typical feed concentration of the marker used in the test; and C_p = the filtrate concentration of the marker from an integral membrane unit.

(D) Systems must establish a control limit within the sensitivity limits of the direct integrity test that is indicative of an integral membrane unit capable of meeting the removal credit awarded by the Department.

(E) If the result of a direct integrity test exceeds the control limit established under R.61-58.10.K(20)(b)(iii)(D), the system must remove the membrane unit from service. Systems must conduct a direct integrity test to verify any repairs, and may return the membrane unit to service only if the direct integrity test is within the established control limit.

(F) Systems must conduct direct integrity testing on each membrane unit at a frequency of not less than once each day that the membrane unit is in operation. The Department may approve less frequent testing, based on demonstrated process reliability, the use of multiple barriers effective for *Cryptosporidium*, or reliable process safeguards.

(iv) Indirect integrity monitoring. Systems must conduct continuous indirect integrity monitoring on each membrane unit according to the criteria in R.61-58.10.K(20)(b)(iv)(A) through (E). Indirect integrity monitoring is defined as monitoring some aspect of filtrate water quality that is indicative of the removal of particulate matter. A system that implements continuous direct integrity testing of membrane units in accordance with the criteria in R.61-58.10.K(20)(b)(iii)(A) through (E) is not subject to the requirements for continuous indirect integrity monitoring. Systems must submit a monthly report to the Department summarizing all continuous indirect integrity monitoring results triggering direct integrity testing and the corrective action that was taken in each case.

(A) Unless the Department approves an alternative parameter, continuous indirect integrity monitoring must include continuous filtrate turbidity monitoring.

(B) Continuous monitoring must be conducted at a frequency of no less than once every 15 minutes.

(C) Continuous monitoring must be separately conducted on each membrane unit.

(D) If indirect integrity monitoring includes turbidity and if the filtrate turbidity readings are above 0.15 NTU for a period greater than 15 minutes (i.e., two consecutive 15-minute readings above 0.15 NTU), direct integrity testing must immediately be performed on the associated membrane unit as specified in R.61-58.10.K(20)(b)(iii)(A) through (E).

(E) If indirect integrity monitoring includes a Department-approved alternative parameter and if the alternative parameter exceeds a Department-approved control limit for a period greater than 15 minutes, direct integrity testing must immediately be performed on the associated membrane units as specified in R.61-58.10.K(20)(b)(iii)(A) through (E).

(c) Second stage filtration. With Department approval, systems may receive 0.5-log *Cryptosporidium* treatment credit for a separate second stage of filtration that consists of sand, dual media, GAC, or other fine grain media following granular media filtration. To receive this credit, the first stage of filtration must be preceded by a coagulation step and both filtration stages must treat the entire plant flow taken from a surface water or GWUDI source. A cap, such as GAC, on a single stage of filtration is not eligible for this credit. The Department must approve the treatment credit based on an assessment of the design characteristics of the filtration process.

(d) Slow Sand Filtration (as Secondary Filter).

With Department approval, systems may receive 2.5-log Cryptosporidium treatment credit for a slow sand filtration process that follows a separate stage of filtration if both filtration stages treat entire plant flow taken from a surface water or GWUDI source and no disinfectant residual is present in the influent water to the slow sand filtration process. The Department must approve the treatment credit based on an assessment of the design characteristics of the filtration process. This paragraph does not apply to treatment credit awarded to slow sand filtration used as a primary filtration process.

(21) Inactivation Toolbox Components.

(a) Calculation of CT Values.

(i) CT is the product of the disinfectant contact time (T, in minutes) and disinfectant concentration (C, in milligrams per liter). Systems with treatment credit for chlorine dioxide or ozone under R.61-58.10.K(21)(b) or (c) must calculate CT at least once each day, with both C and T measured during peak hourly flow as specified in R.61-58.10.F(1) and (2).

(ii) Systems with several disinfection segments in sequence may calculate CT for each segment, where a disinfection segment is defined as a treatment unit process with a measurable disinfectant residual level and a liquid volume. Under this approach, systems must add the Cryptosporidium CT values in each segment to determine the total CT for the treatment plant.

(b) CT values for Chlorine Dioxide and Ozone.

(i) Systems may receive the Cryptosporidium treatment credit listed in the following table by meeting the corresponding chlorine dioxide CT value for the applicable water temperature, as described in R.61-58.10.K(21)(a).

CT Values (mg-min/L) for Cryptosporidium Inactivation by Chlorine Dioxide

Log Credit	Water Temperature (degrees C)										
	Less than or equal to 0.5	1	2	3	5	7	10	15	20	25	30
0.25	159	153	140	128	107	90	69	45	29	19	12
0.5	319	305	279	256	214	180	138	89	58	38	24
1.0	637	610	558	511	429	360	277	179	116	75	49
1.5	956	915	838	767	643	539	415	268	174	113	73
2.0	1275	1220	1117	1023	858	719	553	357	232	150	98
2.5	1594	1525	1396	1278	1072	899	691	447	289	188	122
3.0	1912	1830	1675	1534	1286	1079	830	536	347	226	147

Note: Systems may use this equation to determine log credit between the indicated values: $\text{Log credit} = (0.001506 \times (1.09116)^{\text{Temp}}) \times \text{CT}$.

(ii) Systems may receive the Cryptosporidium treatment credit listed in the following table by meeting the corresponding ozone CT values for the applicable water temperature, as described in R.61-58.10.K(21)(a).

CT Values (mg-min/L) for Cryptosporidium Inactivation by Ozone

Log Credit	Water Temperature (degrees C)										
	Less than or equal to 0.5	1	2	3	5	7	10	15	20	25	30
0.25	6	5.8	5.2	4.8	4.0	3.3	2.5	1.6	1.0	0.6	.39
0.5	12	12	10	9.5	7.9	6.5	4.9	3.1	2.0	1.2	.78
1.0	24	23	21	19	16	13	9.9	6.2	3.9	2.5	1.6
1.5	36	35	31	29	24	20	15	9.3	5.9	3.7	2.4
2.0	48	46	42	38	32	26	20	12	7.8	4.9	3.1
2.5	60	58	52	48	40	33	25	16	9.8	6.2	3.9
3.0	72	69	63	57	47	39	30	19	12	7.4	4.7

Systems may use this equation to determine log credit between the indicated values: $\text{Log credit} = (0.0397 \times (1.09757)^{\text{Temp}}) \times \text{CT}$

(c) Site-Specific Study.

The Department may approve alternative chlorine dioxide or ozone CT values to those listed in R.61-58.10.K(21)(b) on a site-specific basis. The Department must base this approval on a site-specific study a system conducts that follows a Department-approved protocol.

(d) Ultraviolet Light.

Systems may receive Cryptosporidium, Giardia lamblia, and virus treatment credits for ultraviolet (UV) light reactors by achieving the corresponding UV dose values shown in R.61-58.10.K(21)(d)(i). Systems must validate and monitor UV reactors as described in R.61-58.10.K(21)(d)(ii) and (iii) to demonstrate that they are achieving a particular UV dose value for treatment credit.

(i) UV Dose Table.

The treatment credits listed in this table are for UV light at a wavelength of 254 nanometers as produced by a low-pressure mercury vapor lamp. To receive treatment credit for other lamp types, systems must demonstrate an equivalent germicidal dose through reactor validation testing, as described in R.61-58.10.K(21)(d)(ii). The UV dose values in this table are applicable only to post-filter applications of UV in filtered systems and to unfiltered systems.

UV Dose Table for Cryptosporidium, Giardia lamblia, and Virus Inactivation Credit

Log Credit	Cryptosporidium UV dose (mJ/cm ²)	Giardia lamblia UV dose (mJ/cm ²)	Virus UV dose (mJ/cm ²)
0.5	1.6	1.5	39
1.0	2.5	2.1	58
1.5	3.9	3.0	79
2.0	5.8	5.2	100
2.5	8.5	7.7	121
3.0	12	11	143
3.5	15	15	163
4.0	22	22	186

(ii) Reactor Validation Testing.

Systems must use UV reactors that have undergone validation testing to determine the operating conditions under which the reactor delivers the UV dose required in R.61-58.10.K(21)(d)(i) (i.e., validated operating conditions). These operating conditions must include flow rate, UV intensity as measured by a UV sensor, and UV lamp status.

(A) When determining validated operating conditions, systems must account for the following factors: UV absorbance of the water; lamp fouling and aging; measurement uncertainty of on-line sensors; UV dose distributions arising from the velocity profiles through the reactor; failure of UV lamps or other critical system components; and inlet and outlet piping or channel configurations of the UV reactor.

(B) Validation testing must include full scale testing of a reactor that conforms uniformly to the UV reactors used by the system. In addition, the validation testing must include inactivation information on a test microorganism whose dose response characteristics have been quantified with a low-pressure mercury vapor lamp.

(C) The Department may approve an alternative approach to validation testing.

(iii) Reactor Monitoring.

(A) Systems must monitor their UV reactors to determine if the reactors are operating within validated conditions, as determined under R.61-58.10.K(21)(d)(ii). This monitoring must include UV intensity as measured by a UV sensor, flow rate, lamp status, and other parameters the Department designates based on UV reactor operation. Systems must verify the calibration of UV sensors and must recalibrate sensors in accordance with a protocol the Department approves.

(B) To receive treatment credit for UV light, systems must treat at least 95 percent of the water delivered to the public during each month by UV reactors operating within validated conditions for the required UV dose, as described in R.61-58.10.K(21)(d)(i) and (ii). Systems must demonstrate compliance with this condition by the monitoring required under R.61-58.10.K(21)(d)(iii)(A).

(22) Reporting Requirements.

(a) Systems must report sampling schedules under R.61-58.10.K(3) and source water monitoring results under R.61-58.10.K(7) unless they notify the Department that they will not conduct source water monitoring due to meeting the criteria of R.61-58.10.K(2)(d).

(b) Systems must report the use of uncovered finished water storage facilities to the Department as described in R.61-58.10.K(15).

(c) Filtered systems must report their Cryptosporidium bin classification as described in R.61-58.10.K(11).

(d) Unfiltered systems must report their mean source water Cryptosporidium level as described in R.61-58.10.K(13).

(e) Systems must report disinfection profiles and benchmarks to the Department as described in R.61-58.10.K(9) through (10) prior to making a significant change in disinfection practice.

(f) Systems must report to the Department in accordance with R.61-58.10.K(22)(f)(i) through (xv) for any microbial toolbox options used to comply with treatment requirements under R.61-58.10.K(12) or (13). Alternatively, the Department may approve a system to certify operation within required parameters for treatment credit rather than reporting monthly operational data for toolbox options.

(i) Watershed Control Program

Systems must submit the following information:

(A) A notice of intention to develop a new program or continue an existing watershed control program should be submitted no later than two years before the applicable treatment compliance date in R.61-58.10.K(14).

(B) A watershed control plan should be submitted no later than one year before the applicable treatment compliance date in R.61-58.10.K(14).

(C) An annual status report for the watershed control program must be submitted every 12 months beginning one year after the applicable treatment compliance date in R.61-58.10.K(14).

(D) A watershed sanitary survey report must be submitted for community systems every three years beginning three years after the applicable treatment compliance date in R.61-58.10.K(14). For non-community water systems, the watershed sanitary survey report must be submitted every five years beginning five years after the applicable treatment compliance date in R.61-58.10.K(14).

(ii) Alternative source or intake management: Systems must submit verification that the system has relocated the intake or adopted the intake withdrawal procedure reflected in the monitoring results. The verification must be sent no later than the applicable compliance date in R.61-58.10.K(14).

(iii) Presedimentation: A monthly report must be submitted within 10 days following the month in which the monitoring was conducted that contains verification of continuous basin operation, treatment of 100 percent of the flow, continuous addition of a coagulant, and at least 0.5-log mean reduction of influent turbidity or compliance with alternative Department-approved performance criteria beginning on the applicable treatment compliance date in R.61-58.K(14).

(iv) Two-stage lime softening: A monthly report must be submitted that contains verification that chemical addition and hardness precipitation occurred in two separate and sequential softening stages prior to filtration and verification that both stages treated 100 percent of the plant flow. The monthly report must be submitted within 10 days following the month in which

the monitoring was conducted, beginning on the applicable treatment compliance date in R.61-58.K(14).

(v) Bank Filtration:

(A) Systems must submit information that demonstrates that the aquifer is unconsolidated and predominantly sandy and that the setback distances of at least 25 ft for 0.5-log removal or 50 ft for 1.0-log removal are met. This information must be submitted no later than the applicable treatment compliance date in R.61-58.10.K(14).

(B) If the monthly average of daily maximum turbidity is greater than 1 NTU then the system must report the result and submit an assessment of the cause within 30 days following the month in which the monitoring was conducted beginning on the applicable treatment compliance date in R.61-58.10.K(14).

(vi) Combined filter performance: Systems must submit monthly verification of their combined filter effluent levels within 10 days following the month in which the monitoring was conducted beginning on the applicable treatment compliance date in R.61-58.10.K(14). The report must verify that the combined filter effluent turbidity levels were less than or equal to 0.15 NTU in at least 95 percent of the 4 hour combined filter effluent measurements taken each month.

(vii) Individual filter performance: Systems must submit a report within 10 days following the month in which the monitoring was conducted beginning on the applicable treatment compliance date in R.61-58.10.K(14). The report must verify that the individual filter effluent turbidity levels were less than or equal to 0.15 in at least 95 percent of samples each month in each filter, and that no individual filter turbidity was greater than 0.3 NTU in two consecutive readings 15 minutes apart.

(viii) Demonstration of Performance.

(A) Systems must submit the results from testing following a Department-approved protocol no later than the applicable treatment compliance date in R.61-58.10.K(14).

(B) As required by the Department, systems must submit monthly verification of operation within conditions of Department approval for demonstration of performance credit. This verification must be submitted within 10 days following the month in which monitoring was conducted, beginning on the applicable treatment compliance date in R.61-58.10.K(14).

(ix) Bag Filters and Cartridge Filters:

(A) Systems must submit information that demonstrates that the process meets the definition of bag or cartridge filtration and that the removal efficiency established through challenge testing meets the criteria in R.61-58.10.K(20). This information must be submitted no later than the applicable treatment compliance date in R.61-58.10.K(14).

(B) Systems must submit monthly verification that 100 percent of the plant flow was filtered. The monthly verification must be submitted within 10 days following the month in which monitoring was conducted, beginning on the applicable treatment compliance date in R.61-58.10.K(14).

(x) Membrane Filtration:

(A) Systems must submit results of verification testing demonstrating that the removal efficiency established through challenge testing meets the requirements in R.61-58.10.K(20), the type of integrity test method, and the associated test parameters (resolution, sensitivity, test frequency, control limits, and associated baseline). This information must be submitted no later than the applicable treatment compliance date in R.61-58.10.K(14).

(B) Systems must submit a monthly report that summarizes all direct integrity tests above the control limit, and, if applicable, any turbidity or alternative Department-approved indirect integrity monitoring results triggering direct integrity testing and the corrective action that was taken. This report must be submitted within 10 days following the month that testing was conducted, beginning on the applicable treatment compliance date in R.61-58.10.K(14).

(xi) Second stage filtration: Systems must submit monthly verification that 100 percent of the flow was filtered through both stages and that the first stage was preceded by coagulation. This

verification must be submitted within 10 days following the month that monitoring was conducted, beginning on the applicable treatment compliance date in R.61-58.10.K(14).

(xii) Slow sand filtration (as secondary filter): Systems must submit monthly verification that both a slow sand filter and a preceding separate stage of filtration treated 100 percent of the flow from a subpart H source. This verification must be submitted within 10 days following the month that monitoring was conducted, beginning on the applicable treatment compliance date in R.61-58.10.K(14).

(xiii) Chlorine dioxide: Systems must submit a summary of CT values for each day as described in R.61-58.10.K(21). This summary must be submitted within 10 days following the month that monitoring was conducted, beginning on the applicable treatment compliance date in R.61-58.10.K(14).

(xiv) Ozone: Systems must submit a summary of CT values for each day as described in R.61-58.10.K(21). This summary must be submitted within 10 days following the month that monitoring was conducted, beginning on the applicable treatment compliance date in R.61-58.10.K(14).

(xv) UV:

(A) Systems must submit validation test results demonstrating that the operating conditions achieved the required UV dose. This information must be submitted no later than the applicable treatment compliance date in R.61-58.10.K(14).

(B) Systems must submit a monthly report summarizing the percentage of water entering the distribution system that was not treated by UV reactors operating within validated conditions for the required dose as specified in R.61-58.10.K(22)(d). This report must be submitted within 10 days following the month that monitoring was conducted, beginning on the applicable treatment compliance date in R.61-58.10.K(14).

(23) Recordkeeping Requirements.

(a) Systems must keep results from the initial round of source water monitoring under R.61-58.10.K(2)(a) and the second round of source water monitoring under R.61-58.10.K(2)(b) until 3 years after bin classification under R.61-58.10.K(11) for filtered systems or determination of the mean Cryptosporidium level under R.61-58.10.K(11) for unfiltered systems for the particular round of monitoring.

(b) Systems must keep any notification to the Department that they will not conduct source water monitoring due to meeting the criteria of R.61-58.10.K(2)(d) for 3 years.

(c) Systems must keep the results of treatment monitoring associated with microbial toolbox options under R.61-58.10.K(17) through (21) and with uncovered finished water reservoirs under R.61-58.10.K(15), as applicable, for 3 years.

(24) Requirements to Respond to Significant Deficiencies Identified in Sanitary Surveys Performed by EPA.

(a) A sanitary survey is an onsite review of the water source (identifying sources of contamination by using results of source water assessments where available), facilities, equipment, operation, maintenance, and monitoring compliance of a PWS to evaluate the adequacy of the PWS, its sources and operations, and the distribution of safe drinking water.

(b) For the purposes of this section, a significant deficiency includes a defect in design, operation, or maintenance, or a failure or malfunction of the sources, treatment, storage, or distribution system that EPA determines to be causing, or has the potential for causing the introduction of contamination into the water delivered to consumers.

(c) For sanitary surveys performed by EPA, systems must respond in writing to significant deficiencies identified in sanitary survey reports no later than 45 days after receipt of the report, indicating how and on what schedule the system will address significant deficiencies noted in the survey.

(d) Systems must correct significant deficiencies identified in sanitary survey reports according to the schedule approved by EPA, or if there is no approved schedule, according to the schedule reported under R.61-58.10.K(24)(c) if such deficiencies are within the control of the system.

HISTORY: Amended by State Register Volume 19, Issue No. 7, eff July 28, 1995; State Register Volume 24, Issue No. 2, eff February 25, 2000; State Register Volume 25, Issue No. 9, eff September 28, 2001; State Register

Volume 26, Issue No. 12, eff December 27, 2002; State Register Volume 28, Issue No. 1, eff January 23, 2004; State Register Volume 30, Issue No. 10, eff October 27, 2006; State Register Volume 32, Issue No. 4, eff April 25, 2008; State Register Volume 38, Issue No. 9, Doc. No. 4469, eff September 26, 2014.

61–58.11. Control of Lead and Copper.

Table of Contents

- A. Applicability
- B. General Requirements
- C. Applicability of Corrosion Control Treatment Steps to Small, Medium-Size and Large Water Systems
- D. Description of Corrosion Control Treatment Requirements
- E. Source Water Treatment Requirements
- F. Lead Service Line Inventory and Replacement Requirements
- G. Public Education and Supplemental Monitoring and Mitigation Requirements
- H. Monitoring Requirements for Lead and Copper in Tap Water
- I. Monitoring Requirements for Water Quality Parameters
- J. Monitoring Requirements for Lead and Copper in Source Water
- K. Analytical Methods
- L. Reporting Requirements
- M. Recordkeeping Requirements
- N. Monitoring for Lead in Schools and Child Care Facilities
- O. Small Water System Compliance Flexibility

A. Applicability.

This regulation establishes a treatment technique that includes requirements for corrosion control treatment, source water treatment, lead service line replacement, and public education. These requirements are triggered, in some cases, by lead and copper action levels measured in samples collected at consumers' taps. This regulation shall apply to each community and noncommunity water system, unless the water system meets all of the following conditions:

- (1) Consists only of distribution and storage facilities (and does not have any collection and treatment facilities);
- (2) Obtains all of its water from, but is not owned or operated by, a public water system to which such regulations apply;
- (3) Does not sell water to any person; and
- (4) Is not a carrier which conveys passengers in interstate commerce.

B. General Requirements.

- (1) Applicability, effective date, and compliance deadlines

The requirements of this regulation, R.61–58.11, Control of Lead and Copper, constitute the state primary drinking water regulations for lead and copper.

- (a) The provisions of R.61–58.11 apply to community water systems and non-transient, non-community water systems (in R.61–58.11, referred to as “water systems” or “systems”).

- (b) (Reserved).

- (c) Community water systems and non-transient, non-community water systems must comply with the requirements of R.61–58.11 no later than October 16, 2024, except where otherwise specified at R.61–58.11.C, R.61–58.11.F, R.61–58.11.G, R.61–58.11.H, and R.61–58.11.L, or where an exemption in accordance with 40 CFR part 142, subpart C or F, has been established by the Administrator or where an exemption in accordance with R. 61–58.9 has been issued by the Department.

(d)(i) Until October 16, 2024, community water systems and non-transient, non-community water systems must comply with R.61–58.11, as effective on September 26, 2014.

(ii) If an exemption from R.61–58.11 has been issued in accordance with 40 CFR part 142, subpart C or F, prior to December 16, 2021, then the water systems must comply with R. 61–58.11 as effective on September 26, 2014, until the expiration of that exemption.

(2) Scope

The regulations in R.61–58.11 establish a treatment technique that includes requirements for corrosion control treatment, source water treatment, lead service line inventory, lead service line replacement, public notice, monitoring for lead in schools and child care facilities, and public education. Several of the requirements in R.61–58.11 are prompted by the lead and copper action levels or the lead trigger level, specified in paragraph (3) of this section, as measured in samples collected at consumers' taps. The requirements for sampling for lead in schools and child care facilities and public education requirements in R.61–58.11 apply to all community water systems regardless of the results of the compliance tap sampling.

(3) Lead Trigger Level, Lead Action Level, and Copper Action Level

Trigger levels and action levels must be determined based on tap water samples collected in accordance with the tap sampling monitoring requirements of R.61–58.11.H for the purpose of calculating the 90th percentile and tested using the analytical methods specified in R.61–58.11.K. The trigger level and action levels described in this paragraph (3) are applicable to all sections of R.61–58.11. Trigger level and action levels for lead and copper are as follows:

(a) The lead trigger level is exceeded if the 90th percentile concentration of lead as specified in paragraph (3)(d) of this section is greater than ten micrograms per liter (10 µg/L).

(b) The lead action level is exceeded if the 90th percentile concentration of lead as specified in paragraph (3)(d) of this section is greater than fifteen micrograms per liter (15 µg/L).

(c) The copper action level is exceeded if the 90th percentile concentration of copper as specified in paragraph (3)(d) of this section is greater than 1.3 mg/L.

(d) For purposes of R.61–58.11 the 90th percentile concentration shall be computed as follows:

(i) For systems that do not have lead service line sites and only have sites identified as Tier 3, Tier 4, or Tier 5 under R.61–58.11.H(1).

(A) The results of all lead or copper samples taken during a tap sampling period shall be placed in ascending order from the sample with the lowest concentration to the sample with the highest concentration. Each sampling result shall be assigned a number, ascending by single integers beginning with the number 1 for the sample with the lowest contaminant level. The number assigned to the sample with the highest contaminant level shall be equal to the total number of samples taken.

(B) The number of samples taken during the tap sampling period shall be multiplied by 0.9.

(C) The contaminant concentration in the numbered sample yielded by the calculation in paragraph (3)(d)(i)(B) of this section is the 90th percentile concentration.

(D) For water systems serving fewer than one hundred (100) people that collect five (5) samples per tap sampling period, the 90th percentile concentration is the average of the highest and second highest concentrations.

(E) For a water system that has been allowed by the Department to collect fewer than five (5) samples in accordance with R.61–58.11.H(3) or has failed to collect five (5) samples, the sample result with the highest concentration is considered the 90th percentile value.

(ii) For public water systems with lead service lines with sites identified as Tier 1 or Tier 2 under R.61–58.11.H(1) with enough Tier 1 or Tier 2 sites to meet the minimum number of sites listed in R.61–58.11.H(3):

(A) The results of all lead or copper samples taken at Tier 1 or Tier 2 sites during a tap sampling period shall be placed in ascending order from the sample with the lowest concentration to the sample with the highest concentration. Sample results from Tier 3, Tier 4, or Tier 5 sites shall not be included in this calculation. Each sampling result shall be assigned a number, ascending by single integers beginning with the number one (1) for the sample with the lowest

contaminant level. The number assigned to the sample with the highest contaminant level shall be equal to the total number of samples taken.

(B) The number of samples taken at Tier 1 or Tier 2 sites during the tap sampling period shall be multiplied by 0.9.

(C) The contaminant concentration in the numbered sample yielded by the calculation in paragraph (3)(d)(ii)(B) of this section is the 90th percentile concentration.

(D) For water systems serving fewer than one hundred (100) people that collect five (5) samples per tap sampling period, the 90th percentile concentration is the average of the highest and second highest concentration.

(E) For a public water system that has been allowed by the Department to collect fewer than five (5) samples in accordance with R.61-58.11.H(3), or has failed to collect five (5) samples, the sample result with the highest concentration is considered the 90th percentile value.

(iii) For systems with lead service lines with sites identified as Tier 1 or Tier 2 under R.61-58.11.H(1) with insufficient number of Tier 1 or Tier 2 sites to meet the minimum number of sites listed in R.61-58.11.H(3):

(A) The results of all lead or copper samples taken at Tier 1 or Tier 2 sites along with the highest results from Tier 3, Tier 4, or Tier 5 sites sufficient to meet the minimum number of sites shall be placed in ascending order from the sample with the lowest concentration to the sample with the highest concentration. Sample results from any remaining Tier 3, Tier 4, and Tier 5 sites shall not be included in this calculation. Each sampling result shall be assigned a number, ascending by single integers beginning with the number one (1) for the sample with the lowest contaminant level. The number assigned to the sample with the highest contaminant level shall be equal to the total minimum number of sites listed in R.61-58.11.H(3).

(B) The required minimum number of sites listed in R.61-58.11.H(3) shall be multiplied by 0.9.

(C) The contaminant concentration in the numbered sample yielded by the calculation in paragraph (3)(d)(iii)(B) is the 90th percentile concentration.

(D) For water systems serving fewer than one hundred (100) people that collect five (5) samples per tap sampling period, the 90th percentile concentration is the average of the highest and second highest concentration.

(E) For a public water system that has been allowed by the Department to collect fewer than five (5) samples in accordance with R.61-58.11.H(3), or has failed to collect five (5) samples, the sample result with the highest concentration is considered the 90th percentile value.

(4) Corrosion Control Requirements

(a) All water systems shall install and operate optimal corrosion control treatment in accordance with R.61-58.11.C and R.61-58.11.D, and that meets the definition of optimal corrosion control treatment in R.61-58.B, Definitions.

(b) Any water system that complies with the applicable corrosion control treatment requirements specified by the Department under R.61-58.11.C and R.61-58.11.D, shall be deemed in compliance with the treatment requirement contained in paragraph (4)(a) of this section.

(c) Any small or non-transient, non-community water system that complies with the applicable small system compliance flexibility requirements specified by the Department under R.61-58.11.C(1)(c) and R.61-58.11.O is deemed to be in compliance with the treatment requirement in paragraph (4)(a) of this section.

(d) Any water system shall notify the Department in writing pursuant to R.61-58.11.L(1)(c) of any upcoming long-term change in treatment or addition of a new source as described in R.61-58.11.L(1)(c). The Department must review and approve the addition of a new source or long-term change in water treatment before it is implemented by the water system. The Department may require any such water system to conduct additional monitoring or to take other action the Department deems appropriate to ensure that such water system maintains minimal levels of corrosion control in its distribution system.

(5) Source Water Requirements

(a) Any system exceeding the lead or copper action level shall implement all applicable source water treatment requirements specified by the Department under R.61-58.11.E.

(b) Any system that changes their source water or makes long-term treatment changes shall submit written documentation to the Department describing the change in accordance with R.61-58.11.C(1)(c), R.61-58.11.H(4)(b)(iv), and R.61-58.11.L(1)(c). The Department must review and approve the change before it is implemented by the water system.

(6) Lead Service Line Replacements and Inventory - Lead service line replacements must be conducted as follows:

(a) Any water system exceeding the lead action level specified at paragraph (3) of this section must complete mandatory lead service line replacement. Lead service line replacement must be conducted in accordance with R.61-58.11.F(7) and must include public education pursuant to R.61-58.11.G(1) and (2).

(b) Any water system exceeding the lead trigger level specified at paragraph (3) of this section must complete goal-based lead service line replacement pursuant to R.61-58.11.F(6) and public education pursuant to R.61-58.11.G(7) and (8).

(c) All water systems must prepare an inventory of service lines connected to its distribution system, whether or not they are owned or controlled by the water system, to identify those service lines that are made of lead or of unknown material. The inventory must be prepared in accordance with R.61-58.11.F(1).

(7) Public Education and Notification Requirements — Pursuant to R.61-58.11.G(4), all water systems must provide notification of lead tap water monitoring results to persons served at the sites (taps) that are tested. All community water systems must conduct annual outreach to local and state health agencies pursuant to R.61-58.11.G(9). In addition:

(a) Any water system exceeding the lead action level specified at paragraph (3) of this section shall implement the public education requirements in accordance with R.61-58.11.G(1) and (2).

(b) Any water system exceeding the lead trigger level specified at paragraph (3) of this section shall provide notification to all customers with a lead service line in accordance with R.61-58.11.G(7).

(c) Any water system exceeding the lead action level specified at paragraph (3) of this section shall notify the public in accordance with the public notification requirements in R.61-58.6.E.

(d) Any water system with lead service lines, galvanized requiring replacement, or lead status unknown service lines in their inventory as specified in R.61.58.11.F(1) shall inform all consumers with a lead service line, galvanized requiring replacement, or a lead status unknown service line in accordance with R.61-58.11.G(5).

(e) Any water system that fails to reach its goal lead service line replacement rate as required under R.61-58.11.F(6) shall conduct outreach activities in accordance with R.61-58.11.G(8).

(8) Monitoring and Analytical Requirements - Tap water monitoring for lead and copper, monitoring for water quality parameters, source water monitoring for lead and copper, and analyses of the monitoring results shall be completed in compliance with Sections H, I, J, and K below.

(9) Reporting Requirements - Systems shall report to the Department any information required by the treatment provisions of this section.

(10) Recordkeeping Requirements - Systems shall maintain records in accordance with R.61-58.11.L below.

(11) Violation of the State Primary Drinking Water Regulations - Failure to comply with the applicable requirements of R.61-58.11.B through R.61-58.11.O, including requirements established by the Department pursuant to R.61-58.11, Control of Lead and Copper is a violation of the State Primary Drinking Water Regulations for lead and copper.

(12) Testing in Schools and Child Care Facilities - All community water systems must collect samples from all schools and child care facilities within its distribution system in accordance with R.61-58.11.N.

C. Applicability of Corrosion Control Treatment Steps to Small, Medium-Size and Large Water Systems.

(1) Corrosion Control Treatment

This section sets forth when a system must complete the corrosion control treatment steps for systems in paragraph (4) or (5) of this section to optimize or re-optimize corrosion control treatment based on size, whether the system has corrosion control treatment, and whether it has exceeded the lead trigger and/or action level and/or the copper action level.

(a) Large water system (serving greater than 50,000 people).

(i) Large water systems with corrosion control treatment that exceed either the lead trigger level or copper action level shall complete the corrosion control treatment steps specified in paragraph (4) of this section.

(ii) Large water systems without corrosion control treatment with 90th percentile results as calculated in accordance with R.61-58.11.B(3)(d) that exceed either the lead practical quantitation level of 0.005 mg/L or the copper action level shall complete the corrosion control treatment steps specified in paragraph (5) of this section.

(iii) Large water systems with corrosion control treatment with 90th percentile results as calculated in accordance with R.61-58.11.B(3)(d) that exceed the lead practical quantitation level but do not exceed the lead trigger level or the copper action level may be required by the Department to complete the corrosion control treatment steps in paragraph (4) of this section.

(b) Medium-size water systems (serving greater than 10,000 and 50,000 people or less).

(i) Medium-size water systems with corrosion control treatment that exceed either the lead trigger level or copper action level shall complete the corrosion control treatment steps specified in paragraph (4) of this section.

(ii) Medium-size water systems without corrosion control treatment that exceed either the lead or copper action level shall complete the corrosion control treatment steps specified in paragraph (5) of this section.

(iii) Medium-size water systems without corrosion control treatment that exceed the lead trigger level but do not exceed the lead or copper action levels shall complete the treatment recommendation step specified in paragraph (5)(a) of this section (Step 1). The water system shall complete the remaining steps in paragraph (5) of this section if it subsequently exceeds either the lead or copper action level.

(c) Small water systems (serving 10,000 people or less) and non-transient, non-community water systems.

(i) Small and non-transient, non-community water systems with corrosion control treatment that exceed the lead trigger level or the lead action level but do not exceed the copper action level, shall complete the corrosion control treatment steps specified in paragraph (4) of this section, if corrosion control treatment is approved by the Department as a compliance option under R.61-58.11.O.

(ii) Small and non-transient, non-community water systems with corrosion control treatment that exceed the copper action level shall complete the corrosion control treatment steps specified in paragraph (4) of this section.

(iii) Small and non-transient, non-community water systems without corrosion control treatment that exceed the lead action level shall complete the corrosion control treatment steps specified in paragraph (5) of this section if corrosion control treatment is approved by the Department as a compliance option under R.61-58.11.O.

(iv) Small and non-transient, non-community water systems without corrosion control treatment that exceed the copper action level shall complete the corrosion control treatment steps specified in paragraph (5) of this section.

(2) Systems Deemed to have Optimized Corrosion Control.

A system is deemed to have optimal corrosion control treatment (OCCT) or re-optimized OCCT if the system satisfies one of the criteria specified in paragraphs (2)(a) through (c) of this section. Any such system deemed to have OCCT under this paragraph and which has corrosion control treatment in place shall continue to operate and maintain that treatment and meet any additional requirements that the Department determines to be appropriate to ensure optimal corrosion control treatment is maintained.

(a) A small or medium-size water system without corrosion control treatment is deemed to have optimal corrosion control if the water system does not exceed the lead action level and copper action level during two (2) consecutive six (6)-month tap sampling monitoring periods and thereafter remains at or below the lead trigger level and copper action level in all tap sampling periods conducted in accordance with R.61-58.11.H.

(b) A small or medium-size water system with corrosion control treatment is deemed to have optimal corrosion control treatment if the water system does not exceed the lead trigger level and copper action level during two (2) consecutive six (6)-month monitoring periods conducted in accordance with R.61-58.11.H and thereafter remains at or below the lead trigger level and copper action level in all tap sampling periods conducted in accordance with R.61-58.11.H. Small or medium-size systems with corrosion control treatment that exceed the lead trigger level but do not exceed the lead and copper action levels during two (2) consecutive six (6)-month monitoring periods and thereafter remains at or below the lead and copper action levels in all tap sampling periods conducted in accordance with R.61-58.11.H are deemed to have re-optimized optimal corrosion control treatment if the system meets the requirements of this section. Where the Department has set optimal water quality parameters (OWQPs) under paragraph (4) or (5) of this section a system will not be eligible to be deemed to have optimized or re-optimized OCCT pursuant to paragraph (2) of this section

(c) Any water system is deemed to have optimized or re-optimized corrosion control if it submits results of tap water monitoring in accordance with R.61-58.11.H demonstrating that the 90th percentile tap water lead level is less than or equal to the lead practical quantitation level of 0.005 mg/L and does not exceed the copper action level for two (2) consecutive six (6)-month tap sampling monitoring periods, and does not have optimal water quality parameters that were set by the Department under paragraph (4) or (5) of this section. Any such system with 90th percentile tap sample results that thereafter exceeds the lead practical quantitation level or copper action level during any tap sampling period shall not be eligible to be deemed to have optimized OCCT in accordance with this paragraph (2)(c) without first completing the treatment steps specified in paragraph (4) or (5) of this section

(i) [Reserved]

(ii) Any water system deemed to have optimized corrosion control in accordance with this paragraph (2)(c) shall continue monitoring for lead and copper at the tap no less frequently than once every three (3) calendar years using the reduced number of sites specified in R. 61-58.11.H(3) and collecting the samples at times and locations specified in R. 61-58.11.H(4)(d)(v).

(iii) [Reserved]

(iv) [Reserved]

(v) [Reserved]

(3) Corrosion Control Steps Completion for Small and Medium-Size Water Systems Without Corrosion Control Treatment.

Any small or medium-sized system without corrosion control treatment required to complete the corrosion control steps in paragraph (5) of this section due to its exceedance of the lead or copper action level that does not exceed either the lead or copper action levels during each of two (2) consecutive six (6)-month tap sample monitoring periods pursuant to R.61-58.11.H prior to the start of Step 3 in paragraph (5)(c) of this section or Step 5 in paragraph (5)(e) of this section may cease completing the steps and is not required to complete Step 3 or Step 5, respectively, except that medium-sized systems with lead service lines and small systems with lead service lines that choose the corrosion control option pursuant to R. 61-58.11.O must complete a corrosion control treatment study under paragraph (5)(c)(i) of this section. Any system that initiates Step 5 must complete all remaining steps in paragraphs (5)(f) through (h) of this section and is not permitted to cease the steps. Any system that ceases the steps either prior to Step 3 or Step 5 and thereafter exceeds either the lead or copper action level shall not be permitted to cease the steps a second time and shall complete the applicable treatment steps beginning with the first treatment step which was not previously completed in its entirety. The Department may require a water system to repeat treatment steps previously completed by the water system when the Department determines that this

is necessary to implement the treatment requirements of this section. The Department must notify the system in writing of such a determination and explain the basis for its decision.

(4) Treatment Steps and Deadlines for Water Systems Re-optimizing Corrosion Control Treatment.

Except as provided in paragraph (2) of this section or R.61-58.11.O, water systems with corrosion control treatment shall complete the following corrosion control treatment steps (described in the referenced portions of R.61-58.11.D, R.61-58.11.H, and R.61-58.11.I by the indicated time periods.

(a) Step 1:

(i) A water system other than those covered in paragraph (4)(a)(ii) of this section shall recommend re-optimized optimal corrosion control treatment (R.61-58.11.D(3)) within six (6) months after the end of the tap sampling period during which it exceeds either the lead trigger level or copper action level. The Department may approve modifications of the existing corrosion control treatment without a study for systems that exceed the lead trigger level, but do not exceed the lead or copper action level. The Department shall specify re-optimized corrosion control treatment within six (6) months of receiving the treatment recommendation. The system shall complete modifications to corrosion control treatment to have re-optimized corrosion control treatment installed within six (6) months of the Department specifying re-optimized corrosion control treatment.

(ii) A water system with lead service lines that exceeds the lead action level must harvest lead pipes from the distribution system and construct flowthrough pipe loops and operate the loops with finished water within one (1) year after the end of the tap sampling period during which it exceeds the lead action level. These water systems must proceed to Step 3 in paragraph (4)(c) of this section and conduct the corrosion control studies for re-optimization under paragraph (4)(c)(i) of this section using the pipe loops.

(b) Step 2:

(i) Large water systems shall conduct the corrosion control studies for re-optimization under paragraph (4)(c) of this section (Step 3) unless the system is at or below the lead action level and the Department has approved the modification of the existing corrosion control treatment made under paragraph (4)(c)(i) of this section (Step 1).

(ii) Within twelve (12) months after the end of the tap sampling period during which a small or medium-size water system with corrosion control treatment exceeds the lead trigger level or copper action level, the Department may require the water system to perform corrosion control studies for re-optimization (R.61-58.11.D(3)(b) or (c)). If the Department does not require the system to perform such studies, the Department must specify re-optimized corrosion control treatment (R.61-58.11.D(4)(b)) within the timeframes specified in paragraphs (4)(b)(ii)(A) and (B) of this section. The Department must provide its determination to the system in writing.

(A) For medium-size water systems, within twelve (12) months after the end of the tap sampling period during which such water system exceeds the lead trigger level or copper action level.

(B) For small water systems, within eighteen (18) months after the end of the tap sampling period during which such water system exceeds the lead trigger level or copper action level.

(c) Step 3:

(i) Any water system with lead service lines that exceeded the lead action level shall complete the corrosion control treatment studies for re-optimization within thirty (30) months after the end of the tap sampling period during which it exceeds the lead action level.

(ii) If the water system is required to perform corrosion control studies under paragraph (4)(b) of this section (Step 2), the water system shall complete the studies (R.61-58.11.D(3)(b)) within eighteen (18) months after the Department requires that such studies be conducted.

(d) Step 4:

(i) The Department shall designate re-optimized corrosion control treatment (R.61-58.11.D(4)(c)) within six (6) months after completion of paragraph (4)(c)(i) of this section (Step 3).

(ii) If the water system has performed corrosion control studies under paragraph (4)(b) of this section (Step 2), the Department shall designate re-optimized corrosion control treatment (R.61-58.11.D(4)(b) or (d)) within six (6) months after completion of paragraph (4)(c)(ii) of this section (Step 3).

(e) Step 5:

(i) Large water systems shall complete modifications to corrosion control treatment to have re-optimized corrosion control treatment installed within twelve (12) months after completion of paragraph (4)(d)(i) of this section (Step 4).

(ii) Small or medium-size water systems shall install re-optimized corrosion control treatment (R.61-58.11.D(5)(a)) within twelve (12) months after completion of paragraph (4)(d)(ii) of this section (Step 4).

(f) Step 6: Water systems must complete follow-up sampling (R.61-58.11.H(4)(b) and R.61-58.11.I(3)) within twelve (12) months after completion of paragraph (4)(e)(i) or (ii) of this section (Step 5).

(g) Step 7: The Department must review the water system's installation of treatment and designate optimal water quality control parameters (R.61-58.11.D(6)(a)) within six (6) months of completion of paragraph (4)(f) of this section (Step 6).

(h) Step 8: The water system must operate in compliance with the Department-designated optimal water quality control parameters (R.61-58.11.D(7)) and continue to conduct tap sampling (R.61-58.11.H(4)(c)) and water quality parameter monitoring under R.61-58.11.I(4).

(5) Treatment Steps and Deadlines for Systems Without Corrosion Control Treatment.

Except as provided in paragraph (2) of this section or R.61-58.11.O, water systems without corrosion control treatment must complete the following corrosion control treatment steps (described in the referenced portions of R.61-58.11.D, R.61-58.11.H, and R.61-58.11.I) by the indicated time periods.

(a) Step 1:

(i) A water system other than those covered in paragraph (5)(a)(ii) or (iii) of this section must recommend optimal corrosion control treatment (R.61-58.11.D(1)(a), (b), (c), or (d)) within six (6) months after the end of the tap sampling period during which it exceeds either the lead trigger level or copper action level.

(ii) A water system with lead service lines that exceeds the lead action level must harvest lead pipes from the distribution system and construct flowthrough pipe loops and operate the loops with finished water within one (1) year after the end of the tap sampling period during which it exceeds the lead action level. These water systems must proceed to Step 3 in paragraph (5)(c) of this section and conduct the corrosion control studies for optimization under paragraph (5)(c)(i) of this section using the pipe loops.

(iii) Large water systems under paragraph (1)(a)(ii) of this section must conduct the corrosion control studies for optimization under paragraph (5)(c) of this section (Step 3).

(b) Step 2: Within twelve (12) months after the end of the tap sampling period during which a system exceeds the lead or copper action level, if not otherwise required by this rule, the Department may require the water system to perform corrosion control studies (R. 61-58.11.D(2) below). The Department must notify the system in writing of this requirement. If the Department does not require the system to perform such studies, the Department must specify optimal corrosion control treatment (R.61-58.11.D(4)) within the timeframes established in paragraphs (5)(b)(i) and (ii) of this section. The Department must provide its determination to the system in writing.

(i) For medium-size systems, within eighteen (18) months after the end of the tap sampling monitoring period during which such water system exceeds the lead trigger level or copper action level.

(ii) For small systems, within twenty-four (24) months after the end of the tap sampling monitoring period during which such water system exceeds the lead trigger level or copper action level.

(c) Step 3:

(i) Large water systems with or without lead service lines and medium or small systems with lead service lines that exceed the lead action level shall complete the corrosion control treatment studies for optimization within thirty (30) months after the end of the tap sampling period during which it exceeds the lead action level.

(ii) If the Department requires a water system to perform corrosion control studies under paragraph (5)(b) of this section (Step 2), the water system must complete the studies R.61-58.11.D(3)(a) within eighteen (18) months after the Department notifies the system in writing that such studies must be conducted.

(d) Step 4:

(i) The Department shall designate re-optimized corrosion control treatment (R.61-58.11.D(4)(c)) within six (6) months after completion of paragraph (4)(c)(i) of this section (Step 3).

(ii) If the water system has performed corrosion control studies under paragraph (5)(b) of this section (Step 2), the Department must designate optimal corrosion control treatment (R.61-58.11.D(4)(a)) within six (6) months after completion of paragraph (5)(c) of this section (Step 3).

(e) Step 5: The water system must install optimal corrosion control treatment (R.61-58.11.D(5)(a)) within twenty-four (24) months after the Department designates optimal corrosion control treatment under paragraph (5)(b) or (d) of this section (Step 2 or Step 4).

(f) Step 6: The water system shall complete follow-up sampling (R.61-58.11.H(4)(b) and R.61-58.11.I(3) below) within twelve (12) months after completion of paragraph (5)(e) of this section (Step 5).

(g) Step 7: The Department must review the system's installation of treatment and designate optimal water quality control parameters (R.61-58.11.D(6) below) within six (6) months of completion of paragraph (5)(f) of this section (Step 6).

(h) Step 8: The water system must operate in compliance with the Department-designated optimal water quality control parameters (R.61-58.11.D(7) below) and continue to conduct tap sampling (R.61-58.11.H(4)(c) and water quality parameter monitoring under R.61-58.11.I(4)).

(6) Treatment Steps and Deadlines for Small Community Water Systems and Non-Transient Non-Community Water Systems Electing Corrosion Control Treatment (CCT) as a Compliance Option Under R.51-58.11.O, or as Required by the Department.

Water systems selecting the corrosion control small system compliance flexibility option must complete the following steps by the indicated time periods.

(a) Step 1: A water system recommends corrosion control treatment as a small system compliance flexibility option under R.61-58.11.O(1)(b) within six (6) months after the end of the tap sampling period during which it exceeds either the lead trigger level or the lead action level.

(b) Step 2: The Department approves in writing the recommendation of corrosion control treatment as a small system compliance flexibility option or designates an alternative option in accordance with R.61-58.11.O(1) within six (6) months of the recommendation by the water system in paragraph (6)(a) of this section (Step 1). Water systems required by the Department to optimize or re-optimize corrosion control treatment must follow the schedules in paragraph (4) or (5) of this section, beginning with Step 3 in paragraph (4)(c) or (5)(c) of this section unless the Department specifies optimal corrosion control treatment pursuant to either paragraph (4)(b)(ii) or (5)(b)(ii) of this section, as applicable.

D. Description of Corrosion Control Treatment Requirements.

This section sets forth the requirements applicable to systems and states in the designation of optimal corrosion control treatment (OCCT) for a system that is optimizing or re-optimizing corrosion control treatment. Each system must complete the corrosion control treatment requirements in this section as applicable to such system under R.61-58.11.C.

(1) System Recommendation Regarding Corrosion Control Treatment for Systems that do not Contain Lead Service Lines and Systems with Lead Service Lines that do not Exceed the Lead Action Level.

(a) Any system under this paragraph (1) without corrosion control treatment that is required to recommend a treatment option in accordance with R.61–58.11.C(5) must, based on the results of lead and copper tap sampling and water quality parameter monitoring, recommend designation of one or more of the corrosion control treatments listed in paragraph (3)(a)(i) of this section. Small community water systems and non-transient, non-community water systems that exceed the copper action level must comply with this paragraph (1)(a). The Department may require the system to conduct additional water quality parameter monitoring to assist the Department in reviewing the system’s recommendation.

(b) Any small community water system or non-transient, non-community water system in this paragraph (1) without corrosion control treatment that chooses to pursue a small water system compliance flexibility option and is required to recommend an option in accordance with R.61–58.11.C(6) must, based on the results of lead tap sampling and water quality parameter monitoring, recommend designation of one of the options listed in R.61–58.11.O. Systems with no lead service lines that exceed the lead action level and select corrosion control under R.61–58.11.O(1)(b) must recommend designation of one or more of the corrosion control treatments listed in paragraph (3)(a) of this section as the optimal corrosion control treatment for that system.

(c) Any system under this paragraph (1) that exceeds the lead action level and selects corrosion control under R.61–58.11.O(1)(b) must recommend designation of one or more of the corrosion control treatments listed in paragraph (3)(a)(i) of this section as the optimal corrosion control treatment for that system. A corrosion control study under paragraph (3) of this section is not required for medium and small systems that exceed the lead trigger level but do not exceed the lead and copper action levels, unless required by the Department.

(d) Any small community water system or non-transient, non-community water system with corrosion control treatment that exceeds the lead action level and selects corrosion control under R.61–58.11.O(1)(b) must recommend designation of one or more of the corrosion control treatments listed in paragraph (3)(b) of this section as the optimal corrosion control treatment for that system.

(e) The Department may waive the requirement for a system to recommend OCCT if the Department requires the system, in writing, to complete a corrosion control study within three (3) months after the end of the tap sampling period during which the exceedance occurred. Such systems shall proceed directly to paragraph (3) of this section and complete a corrosion control study.

(2) Department Decision to Require Studies to Identify Initial Optimal Corrosion Control Treatment and Re-optimized Optimal Corrosion Control Treatment Except for Large Systems and Small and Medium Systems with Lead Service Lines that Exceed the Lead Action Level.

Corrosion control treatment studies are always required for large systems that exceed the lead action level, large water systems without corrosion control treatment with 90th percentile results that exceed either the lead practical quantitation level of 0.005 mg/L or the copper action level, medium-size systems with lead service lines that exceed the lead action level, and small systems with lead service lines that exceed the lead action level and select the corrosion control treatment option under R.61–58.11.O(1).

(a) The Department may require any small or medium-size system without corrosion control that exceeds either the lead or copper action level to perform corrosion control treatment studies under paragraph (3)(a) of this section to identify optimal corrosion control treatment for the system.

(b) The Department may require any small or medium-size system without corrosion control that exceeds the lead trigger level but not the lead or copper action level to perform corrosion control treatment studies under paragraph (3)(a) of this section to identify optimal corrosion control treatment for the system. This corrosion control treatment shall be installed if the lead or copper action level is subsequently exceeded.

(c) The Department may require any small or medium-size water systems with corrosion control treatment exceeding either the lead trigger level or copper action level to perform corrosion control treatment studies under paragraph (3)(b) of this section to identify re-optimized optimal corrosion control treatment for the system (i.e., optimal corrosion control treatment after a re-optimization evaluation).

(3) Performance of Corrosion Control Studies

(a) Water systems without corrosion control treatment that are required to conduct corrosion control studies must complete the following:

(i) Any water system without corrosion control treatment must evaluate the effectiveness of each of the following treatments, and if appropriate, combinations of the following treatments to identify the optimal corrosion control treatment for the system:

(A) Alkalinity and pH adjustment;

(B) The addition of an orthophosphate- or silicate-based corrosion inhibitor at a concentration sufficient to maintain an effective corrosion inhibitor residual concentration in all test samples;

(C) The addition of an orthophosphate-based corrosion inhibitor at a concentration sufficient to maintain an orthophosphate residual concentration of one milligram per liter (1 mg/L) (as PO_4) in all test samples; and

(D) The addition of an orthophosphate-based corrosion inhibitor at a concentration sufficient to maintain an orthophosphate residual concentration of three milligrams per liter (3 mg/L) (as PO_4) in all test samples.

(ii) The water system must evaluate each of the corrosion control treatments using either pipe rig/loop tests, metal coupon tests, partial-system tests, or analyses based on documented analogous treatments with other systems of similar size, water chemistry, and distribution system configurations. Large and medium systems, and small community water systems and non-transient, non-community water systems that select the corrosion control treatment option under R.61-58.11.O with lead service lines that exceed the lead action level must conduct pipe rig/loop studies using harvested lead service lines from their distribution systems to assess the effectiveness of corrosion control treatment options on the existing pipe scale. For these systems, metal coupon tests can be used as a screen to reduce the number of options that are evaluated using pipe rig/loops to the current conditions and two (2) options.

(iii) The water system must measure the following water quality parameters in any tests conducted under this paragraph (3)(a)(iii) before and after evaluating the corrosion control treatments listed in paragraphs (3)(a)(i) and (ii) of this section:

(A) Lead;

(B) Copper;

(C) pH;

(D) Alkalinity;

(E) Orthophosphate as PO_4 (when an orthophosphate-based inhibitor is used); and

(F) Silicate (when a silicate-based inhibitor is used).

(iv) The water system must identify all chemical or physical constraints that limit or prohibit the use of a particular corrosion control treatment and document such constraints with one of the following:

(A) Data and documentation showing that a particular corrosion control treatment has adversely affected other drinking water treatment processes when used by another water system with comparable water quality characteristics. Systems using coupon studies to screen and/or pipe loop/rig studies to evaluate treatment options must not exclude treatment strategies from the studies based on the constraints identified in this section.

(B) Data and documentation demonstrating that the water system has previously attempted to evaluate a particular corrosion control treatment and has found that the treatment is ineffective or adversely affects other drinking water quality treatment processes. Systems using coupon studies to screen and/or pipe loop/rig studies to evaluate treatment options must not exclude treatment strategies from the studies based on the constraints identified in this section unless the treatment was found to be ineffective in a previous pipe loop/rig study.

(v) The water system must evaluate the effect of the chemicals used for corrosion control treatment on other drinking water quality treatment processes. Systems using coupon studies to screen and/or pipe loop/rig studies to evaluate treatment options shall not exclude treatment strategies from the studies based on the effects identified in this section.

(vi) On the basis of an analysis of the data generated during each evaluation, the water system must recommend to the Department in writing the treatment option that the corrosion control studies indicate constitutes optimal corrosion control treatment for that system as defined in R.61-58.B. The water system must provide a rationale for its recommendation along with all supporting documentation specified in paragraphs (3)(b)(i) through (v) of this section.

(b) Systems with corrosion control treatment that are required to conduct corrosion control studies to determine re-optimized OCCT must complete the following:

(i) The water system must evaluate the effectiveness of the following treatments, and if appropriate, combinations of the following treatments to identify the re-optimized optimal corrosion control treatment for the system:

(A) Alkalinity and/or pH adjustment, or re-adjustment;

(B) The addition of an orthophosphate- or silicate-based corrosion inhibitor at a concentration sufficient to maintain an effective corrosion inhibitor residual concentration in all test samples if no such inhibitor is utilized;

(C) The addition of an orthophosphate-based corrosion inhibitor at a concentration sufficient to maintain an orthophosphate residual concentration of one milligram per liter (1 mg/L) (PO_4) in all test samples unless the current inhibitor process already meets this residual; and

(D) The addition of an orthophosphate-based corrosion inhibitor at a concentration sufficient to maintain an orthophosphate residual concentration of three milligrams per liter (3 mg/L) (PO_4) in all test samples unless the current inhibitor process already meets this residual.

(ii) The water system must evaluate each of the corrosion control treatments using either pipe rig/loop tests, metal coupon tests, partial-system tests, or analyses based on documented analogous treatments with other systems of similar size, water chemistry, and distribution system configurations. If the water system has lead service lines and exceeds the lead action level, it must conduct pipe rig/loop studies using harvested lead service lines from their distribution systems to assess the effectiveness of corrosion control treatment options on the existing pipe scale. For these systems, metal coupon tests can be used as a screen to reduce the number of options that are evaluated using pipe rig/loops to the current conditions and two (2) options.

(iii) The water system must measure the following water quality parameters in any tests conducted under this paragraph (3)(b)(iii) before and after evaluating the corrosion control treatments listed in paragraphs (3)(b)(i) and (ii) of this section:

(A) Lead;

(B) Copper;

(C) pH;

(D) Alkalinity;

(E) Orthophosphate as PO_4 (when an orthophosphate-based inhibitor is used); and

(F) Silicate (when a silicate-based inhibitor is used).

(iv) The water system must identify all chemical or physical constraints that limit or prohibit the use of a particular corrosion control treatment and document such constraints with one of the following:

(A) Data and documentation showing that a particular corrosion control treatment has adversely affected other drinking water treatment processes when used by another water system with comparable water quality characteristics. Systems using coupon studies to screen and/or pipe loop/rig studies to evaluate treatment options must not exclude treatment strategies from the studies based on the constraints identified in this section.

(B) Data and documentation demonstrating that the water system has previously attempted to evaluate a particular corrosion control treatment and has found that the treatment is ineffective or adversely affects other drinking water quality treatment processes. Systems using coupon studies to screen and/or pipe loop/rig studies to evaluate treatment options shall not exclude treatment strategies from the studies based on the constraints identified in this section unless the treatment was found to be ineffective in a previous pipe loop/rig study.

(v) The water system must evaluate the effect of the chemicals used for corrosion control treatment on other drinking water quality treatment processes. Systems using coupon studies to screen and/or pipe loop/rig studies to evaluate treatment options shall not exclude treatment strategies from the studies based on the effects identified in this section.

(vi) On the basis of an analysis of the data generated during each evaluation, the water system must recommend to the Department in writing the treatment option that the corrosion control studies indicate constitutes optimal corrosion control treatment for that system as defined in R.61-58.B. The water system must provide a rationale for its recommendation along with all supporting documentation specified in paragraph (3)(a)(i) through (v) of this section.

(4) Department Designation of Optimized Optimal Corrosion Control Treatment and Re-optimized Optimal Corrosion Control Treatment.

When designating optimal corrosion control treatment, the Department must consider the effects that additional corrosion control treatment will have on water quality parameters and on other drinking water quality treatment processes. The Department must notify the water system of its designation of optimal corrosion control treatment in writing and explain the basis for this determination. If the Department requests additional information to aid its review, the water system must provide the information.

(a) Designation of OCCT for systems without corrosion control treatment.

Based upon considerations of available information including, where applicable, studies conducted under paragraph (3)(a) of this section and/or a system's recommended corrosion control treatment option, the Department must either approve the corrosion control treatment option recommended by the system or designate alternative corrosion control treatment(s) from among those listed in paragraph (3)(a)(i) of this section or, where applicable, an alternate small water system compliance flexibility option under R.61-58.11.O(1).

(b) Designation of re-optimized OCCT for systems with corrosion control treatment.

Based upon considerations of available information including, where applicable, studies conducted under paragraph (3)(b) of this section and/or a system's recommended treatment alternative, the Department must either approve the corrosion control treatment option recommended by the water system or designate alternative corrosion control treatment(s) from among those listed in paragraph (3)(b)(i) of this section or, where applicable, an alternate small water system compliance flexibility option under R.61-58.11.O.

(5) Installation of Optimal Corrosion Control Treatment and Re-optimization of Corrosion Control Treatment.

Each system shall properly install and operate throughout its distribution system the optimal corrosion control treatment designated by the Department under paragraph (4) of this section.

(6) Department Review of Treatment and Specification of Optimal Water Quality Control Parameters for Optimal Corrosion Control Treatment and Reoptimized Corrosion Control Treatment.

The Department must evaluate the results of all lead and copper tap sampling and water quality parameter sampling submitted by the water system and determine whether the water system has properly installed and operated the optimal corrosion control treatment designated by the Department in paragraph (4)(a) or (b) of this section, respectively. Upon reviewing the results of tap water and water quality parameter monitoring by the water system, both before and after the water system installs optimal corrosion control treatment, the Department must designate:

(a) A minimum value or a range of values for pH measured at each entry point to the distribution system.

(b) A minimum pH value, measured in all tap samples. Such a value shall be equal to or greater than 7.0, unless the Department determines that meeting a pH level of 7.0 is not technologically feasible or is not necessary for the system to optimize corrosion control.

(c) If a corrosion inhibitor is used, a minimum concentration or a range of concentrations for the orthophosphate (as PO_4) or silicate measured at each entry point to the distribution.

(d) If a corrosion inhibitor is used, a minimum orthophosphate or silicate concentration measured in all tap samples that the Department determines is necessary to form a passivating film on the interior walls of the pipes of the distribution system. When orthophosphate is used, such an

orthophosphate concentration shall be equal to or greater than 0.5 mg/L (as PO₄) for OCCT designations under paragraph (4)(a) of this section and 1.0 mg/L for OCCT designations under paragraph (4)(b) of this section, unless the Department determines that meeting the applicable minimum orthophosphate residual is not technologically feasible or is not necessary for optimal corrosion control treatment.

(e) If alkalinity is adjusted as part of optimal corrosion control treatment, a minimum concentration or a range of concentrations for alkalinity, measured at each entry point to the distribution system and in all tap samples.

(f) The values for the applicable water quality control parameters, previously listed in this section, shall be those that the Department determines to reflect optimal corrosion control treatment for the water system. The Department may designate values for additional water quality control parameters determined by the Department to reflect optimal corrosion control treatment for the water system. The Department must notify the system in writing of these determinations and explain the basis for its decisions.

(7) Continued Operation and Monitoring for Optimal Corrosion Control Treatment and Re-optimized Optimal Corrosion Control Treatment.

All systems optimizing or re-optimizing corrosion control must continue to operate and maintain optimal corrosion control treatment, including maintaining water quality parameters at or above minimum values or within ranges designated by the Department under paragraph (6) of this section, in accordance with this paragraph (7) for all samples collected under R.61-58.11.I(4) through (6). The requirements of this paragraph (7) apply to all systems, including consecutive systems that distribute water that has been treated to control corrosion by another system, and any water system with corrosion control treatment, optimal corrosion control treatment, or re-optimized OCCT that is not required to monitor water quality parameters under R.61-58.11.I. Compliance with the requirements of this paragraph (7) shall be determined every six (6) months, as specified under R.61-58.11.I(4). A water system is out of compliance with the requirements of this paragraph (7) for a six (6)-month period if it has excursions for any Department-specified parameter on more than nine (9) days, cumulatively, during the period. An excursion occurs whenever the daily value for one or more of the water quality parameters measured at a sampling location is below the minimum value or outside the range designated by the Department. Daily values are calculated as set out in paragraphs (7)(a) through (c) of this section. The Department has the discretion to not include results of obvious sampling errors from this calculation. Sampling errors must still be recorded even when not included in calculations.

(a) On days when more than one (1) measurement for the water quality parameter is collected at the sampling location, the daily value must be the average of all results collected during the day regardless of whether they are collected through continuous monitoring, grab sampling, or a combination of both. If EPA has approved an alternative formula under 40 CFR 142.16(d)(1)(ii) in the Department's application for a program revision submitted pursuant to 40 CFR 142.12, the Department's formula shall be used to aggregate multiple measurements taken at a sampling point for the water quality parameters in lieu of the formula in this paragraph (7)(a).

(b) On days when only one (1) measurement for the water quality parameter is collected at the sampling location, the daily value shall be the result of that measurement.

(c) On days when no measurement is collected for the water quality parameter at the sampling location, the daily value shall be the daily value calculated on the most recent day on which the water quality parameter was measured at the sampling location.

(8) Modification of Department Treatment Decisions for Optimal Corrosion Control and Re-optimized Corrosion Control.

Upon its own initiative or in response to a request by a water system or other interested party, the Department may modify its determination of the optimal corrosion control treatment under paragraph (4) of this section, or optimal water quality control parameters under paragraph (6) of this section. A request for modification by a system or other interested party shall be in writing, explaining why the modification is appropriate, and providing supporting documentation. The Department may modify its determination where it concludes that such change is necessary to ensure that the water system continues to optimize corrosion control treatment. A revised determination must be made in writing, set forth the new treatment requirements and/or water quality

parameters, explain the basis for the Department's decision, and provide an implementation schedule for completing the treatment modifications for re-optimized corrosion control treatment.

(9) Treatment Decisions by EPA in lieu of the Department on Optimal Corrosion Control Treatment and Re-optimized Corrosion Control Treatment.

Pursuant to the procedures in 40 CFR 142.19, EPA Regional Administrator may review optimal corrosion control treatment determinations made by the Department under paragraph (4)(a) or (b), (6), or (8) of this section and issue Federal treatment determinations consistent with the requirements of paragraph (4)(a) or (b), (6), or (8) of this section where the Regional Administrator finds that:

(a) A Department has failed to issue a treatment determination by the applicable deadlines contained in R.61-58.11.C;

(b) A Department has abused its discretion in a substantial number of cases or in cases affecting a substantial population; or

(c) The technical aspects of a Department's determination would be indefensible in a Federal enforcement action taken against a water system.

(10) Find-and-fix Assessment for Tap Sample Sites that Exceed the Lead Action Level.

The water system shall conduct the following steps, when a tap sample site exceeds the lead action level under monitoring conducted under R.61-58.11.H.

(a) Step 1: Corrosion Control Treatment Assessment. The water system must sample at a new water quality parameter site that is on the same size water main in the same pressure zone and located within a half mile of the location with the action level exceedance within five (5) days of receiving the sample results. Small water systems without corrosion control treatment may have up to fourteen (14) days to collect the samples. The water system must measure the following parameters:

(i) pH;

(ii) Alkalinity;

(iii) Orthophosphate (as PO_4), when an inhibitor containing an orthophosphate compound is used;

(iv) Silica, when an inhibitor containing a silicate compound is used; and

(v) Water systems with an existing water quality parameter location that meets the requirements of this section can conduct this sampling at that location.

(vi) All water systems required to meet optimal water quality control parameters but that do not have an existing water quality parameter location that meets the requirement of this section must add new sites to the minimum number of sites as described in R.61-58.11.I(7). Sites must be added until a system has twice the minimum number of sites listed in Table 1 to R.61-58.11.I(1)(b). When a system exceeds this upper threshold for the number of sites, the Department has discretion to determine if the newer site can better assess the effectiveness of the corrosion control treatment and to remove existing sites during sanitary survey evaluation of OCCT.

(b) Step 2: Site Assessment. Water systems shall collect a follow-up sample at any tap sample site that exceeds the action level within thirty (30) days of receiving the sample results. These follow-up samples may use different sample volumes or different sample collection procedures to assess the source of elevated lead levels. Samples collected under this section must be submitted to the Department but shall not be included in the 90th percentile calculation for compliance monitoring under R.61-58.11.H. If the water system is unable to collect a follow-up sample at a site, the water system must provide documentation to the Department, explaining why it was unable to collect a follow-up sample.

(c) Step 3: Water systems shall evaluate the results of the monitoring conducted under this paragraph (10)(c) to determine if either localized or centralized adjustment of the optimal corrosion control treatment or other distribution system actions are necessary and submit the recommendation to the Department within six months after the end of the tap sampling period in which the site(s) exceeded the lead action level. Corrosion control treatment modification may not be necessary to

address every exceedance. Other distribution system actions may include flushing to reduce water age. Water systems must note the cause of the elevated lead level, if known from the site assessment, in their recommendation to the Department as site-specific issues can be an important factor in why the system is not recommending any adjustment of corrosion control treatment or other distribution system actions. Systems in the process of optimizing or reoptimizing optimal corrosion control treatment under paragraphs (1) through (6) of this section do not need to submit a treatment recommendation for find-and-fix.

(d) Step 4: The Department shall approve the treatment recommendation or specify a different approach within six (6) months of completion of Step 3 as described in paragraph (10)(c) of this section.

(e) Step 5: If the Department-approved treatment recommendation requires the water system to adjust the optimal corrosion control treatment process, the water system must complete modifications to its corrosion control treatment within twelve (12) months after completion of Step 4 as described in paragraph (10)(d) of this section. Systems without corrosion control treatment required to install optimal corrosion control treatment must follow the schedule in R.61-58.11.C(5).

(f) Step 6: Water systems adjusting its optimal corrosion control treatment must complete follow-up sampling (R.61-58.11.H(4)(b) and R.61-58.11.I(3)) within twelve (12) months after completion of Step 5 as described in paragraph (10)(e) of this section.

(g) Step 7: For water systems adjusting its optimal corrosion control treatment, the Department must review the water system's modification of corrosion control treatment and designate optimal water quality control parameters (R.61-58.11.D(6)(a)) within six (6) months of completion of Step 6 as described in paragraph (10)(f) of this section.

(h) Step 8: For a water system adjusting its optimal corrosion control treatment, the water system must operate in compliance with the Department-designated optimal water quality control parameters (R.61-58.11.D(7)) and continue to conduct tap sampling (R.61-58.11.H(4)(c) and R.61-58.11.I(4)).

E. Source Water Treatment Requirements.

Systems shall complete the applicable source water monitoring and treatment requirements (described in the referenced portions of paragraph (2) of this section, and in R.61-58.11.H and R.61-58.11.J by the following deadlines.

(1) Deadlines for Completing Source Water Treatment Steps

(a) Step 1: A system exceeding the lead or copper action level shall complete lead and copper source water monitoring (R.61-58.11.J(2) below) and make a treatment recommendation to the Department (paragraph (2)(a) of this section) no later than one hundred eighty (180) days after the end of the monitoring period during which the lead or copper action level was exceeded.

(b) Step 2: The Department shall make a determination regarding source water treatment (paragraph (2)(b) of this section) within six (6) months after submission of monitoring results under Step 1.

(c) Step 3: If the Department requires installation of source water treatment, the system shall install the treatment (paragraph (2)(c) of this section) within twenty-four (24) months after completion of Step 2.

(d) Step 4: The system shall complete follow-up tap water monitoring (R.61-58.11.H(4)(b) below) and source water monitoring (R.61-58.11.J(3) below) within thirty-six (36) months after completion of Step 2.

(e) Step 5: The Department shall review the system's installation and operation of source water treatment and specify maximum permissible source water levels (paragraph (2)(d) of the section) within six (6) months after completion of Step 4.

(f) Step 6: The system shall operate in compliance with the Department-specified maximum permissible lead and copper source water levels (paragraph (2)(d) of this section) and continue source water monitoring (R.61-58.11.J(4) below).

(2) Description of Source Water Treatment Requirements

(a) System Treatment Recommendation - Any system which exceeds the lead or copper action level shall recommend in writing to the Department the installation and operation of one of the source water treatments listed in paragraph (2)(b) of this section. A system may recommend that no treatment be installed based upon a demonstration that source water treatment is not necessary to minimize lead and copper levels at users' taps.

(b) Department Determination Regarding Source Water Treatment - The Department shall complete an evaluation of the results of all source water samples submitted by the water system to determine whether source water treatment is necessary to minimize lead or copper levels in water delivered to users' taps. If the Department determines that treatment is needed, the Department shall either require installation and operation of the source water treatment recommended by the system (if any) or require the installation and operation of another source water treatment from among the following: ion exchange, reverse osmosis, lime softening or coagulation/filtration. If the Department requests additional information to aid in its review, the water system shall provide the information by the date specified by the Department in its request. The Department shall notify the system in writing of its determination and set forth the basis for its decision.

(c) Installation of Source Water Treatment - Each system shall properly install and operate the source water treatment designated by the Department under paragraph (2)(b) of this section.

(d) Department Review of Source Water Treatment and Specification of Maximum Permissible Source Water Levels - The Department shall review the source water samples taken by the water system both before and after the system installs source water treatment, and determine whether the system has properly installed and operated the source water treatment designated by the Department. Based upon its review, the Department shall designate the maximum permissible lead and copper concentrations for finished water entering the distribution system. Such levels shall reflect the contaminant removal capability of the treatment properly operated and maintained. The Department shall notify the system in writing and explain the basis for its decision.

(e) Continued Operation and Maintenance - Each water system shall maintain lead and copper levels below the maximum permissible concentrations designated by the Department at each sampling point monitored in accordance with R.61-58.11.J. The system is out of compliance with this paragraph if the level of lead or copper at any sampling point is greater than the maximum permissible concentration designated by the Department.

(f) Modification of Department Treatment Decisions - Upon its own initiative or in response to a request by a water system or other interested party, the Department may modify its determination of the source water treatment under paragraph (2)(b) of this section, or maximum permissible lead and copper concentrations for finished water entering the distribution system under paragraph (2)(d) of this section. A request for modification by a system or other interested party shall be in writing, explain why the modification is appropriate, and provide supporting documentation. The Department may modify its determination where it concludes that such change is necessary to ensure that the system continues to minimize lead and copper concentrations in source water. A revised determination shall be made in writing, set forth the new treatment requirements, explain the basis for the Department's decision, and provide an implementation schedule for completing the treatment modifications.

F. Lead Service Line Inventory and Replacement Requirements.

(1) Lead Service Line Inventory.

All water systems must develop an inventory to identify the materials of service lines connected to the public water distribution system. The inventory must meet the following requirements:

(a) All water systems must develop an initial inventory by January 16, 2024, and submit it to the primacy agency in accordance with R.61-58.11.L(5).

(b) The inventory must include all service lines connected to the public water distribution system regardless of ownership status (e.g., where service line ownership is shared, the inventory would include both the portion of the service line owned by the water system and the customer-owned portion of the service line).

(c) A water system must use any information on lead and galvanized iron or steel that it has identified pursuant to R.61-58.5.V when conducting the inventory of service lines in its distribution system for the initial inventory under paragraph (1)(a) of this section. The water system must also

review the sources of information listed in paragraphs (1)(c)(i) through (iv) of this section to identify service line materials for the initial inventory. The water system may use other sources of information not listed in paragraphs (1)(c)(i) through (iv) of this section if approved by the Department.

(i) All construction and plumbing codes, permits, and existing records or other documentation which indicates the service line materials used to connect structures to the distribution system.

(ii) All water system records, including distribution system maps and drawings, historical records on each service connection, meter installation records, historical capital improvement or master plans, and standard operating procedures.

(iii) All inspections and records of the distribution system that indicate the material composition of the service connections that connect a structure to the distribution system.

(iv) Any resource, information, or identification method provided or required by the Department to assess service line materials.

(d) Each service line, or portion of the service line where ownership is split, must be categorized in the following manner:

(i) "Lead" where the service line is made of lead.

(ii) "Galvanized Requiring Replacement" where a galvanized service line is or was at any time downstream of a lead service line or is currently downstream of a "Lead Status Unknown" service line. If the water system is unable to demonstrate that the galvanized service line was never downstream of a lead service line, it must presume there was an upstream lead service line.

(iii) "Non-lead" where the service line is determined through an evidence-based record, method, or technique not to be lead or galvanized requiring replacement. The water system may classify the actual material of the service line (i.e., plastic or copper) as an alternative to classifying it as "Non-lead."

(iv) "Lead Status Unknown" where the service line material is not known to be lead, galvanized requiring replacement, or a non-lead service line, such as where there is no documented evidence supporting material classification. The water system may classify the line as "Unknown" as an alternative to classifying it as "Lead Status Unknown," however, all requirements that apply to "Lead Status Unknown" service lines must also apply to those classified as "Unknown." Water systems may elect to provide more information regarding their unknown lines as long as the inventory clearly distinguishes unknown service lines from those where the material has been verified through records or inspection.

(e) Water systems shall identify and track service line materials in the inventory as they are encountered in the course of its normal operations (e.g., checking service line materials when reading water meters or performing maintenance activities).

(f) Water systems must update the inventory based on all applicable sources described in paragraphs (1)(c) and (e) of this section and any lead service line replacements or service line material inspections that may have been conducted. The water system may use other sources of information if approved by the Department and must use other sources of information provided or required by the Department. Water systems must submit the updated inventory to the Department in accordance with R.61-58.11.L(5). The inventory updates must be reflected in the publicly accessible inventory no less frequently than when required to be submitted to the Department.

(i) Water systems whose inventories contain only non-lead service lines are not required to provide inventory updates to the Department or to the public. If, in the future, such a water system finds a lead service line within its system, it must prepare an updated inventory in accordance with paragraph (1) of this section on a schedule established by the Department.

(ii) [Reserved]

(g) To calculate the number of service line replacements applicable to paragraphs (6) and (7) of this section, the replacement rate must be applied to the sum of known lead and galvanized requiring replacement service lines when the system first exceeds the trigger or action level plus the number of lead status unknown service lines in the beginning of each year of a system's annual goal or mandatory lead service line replacement program.

(i) Each service line shall count only once for purposes of calculating the required number of service line replacements, even where the ownership of the service line is split and both the customer-owned and system-owned portions require replacement.

(ii) The number of service lines requiring replacement must be updated annually to subtract the number of lead status unknown service lines that were discovered to be non-lead and to add the number of non-lead service lines that were discovered to be a lead or galvanized requiring replacement service line.

(iii) Verification of a lead status unknown service line as non-lead in the inventory does not count as a service line replacement.

(h) The service line materials inventory must be publicly accessible.

(i) The inventory must include a location identifier, such as a street address, block, intersection, or landmark, associated with each lead service line and galvanized requiring replacement service line. Water systems may, but are not required to, include a locational identifier for lead status unknown service lines or list the exact address of each service line.

(ii) Water systems serving greater than 50,000 persons must make the publicly accessible inventory available online.

(i) When a water system has no lead, galvanized requiring replacement, or lead status unknown service lines (regardless of ownership) in its inventory, it may comply with the requirements in paragraph (1)(h) of this section using a written statement, in lieu of the inventory, declaring that the distribution system has no lead service lines or galvanized requiring replacement service lines. The statement must include a general description of all applicable sources described in paragraphs (1)(c), (e), and (f) of this section used to make this determination.

(j) Instructions to access the service line inventory (including inventories consisting only of a statement in accordance with paragraph (1)(i) of this section) must be included in Consumer Confidence Report in accordance with R.61-58.12.C(4)(d)(xi).

(2) Lead Service Line Replacement Plan.

All water systems with one (1) or more lead, galvanized requiring replacement, or lead status unknown service lines in their distribution system must, by January 16, 2024, submit a lead service line replacement plan to the Department in accordance with R.61-58.11.L(5). The lead service line replacement plan must be sufficiently detailed to ensure a system is able to comply with the lead service line replacement requirements in accordance with this section. The plan must include a description of:

(a) A strategy for determining the composition of lead status unknown service lines in its inventory;

(b) A procedure for conducting full lead service line replacement;

(c) A strategy for informing customers before a full or partial lead service line replacement;

(d) For systems that serve more than 10,000 persons, a lead service line replacement goal rate recommended by the system in the event of a lead trigger level exceedance;

(e) A procedure for customers to flush service lines and premise plumbing of particulate lead;

(f) A lead service line replacement prioritization strategy based on factors including, but not limited to, the targeting of known lead service lines, lead service line replacement for disadvantaged consumers and populations most sensitive to the effects of lead; and

(g) A funding strategy for conducting lead service line replacements which considers ways to accommodate customers that are unable to pay to replace the portion they own.

(3) Operating Procedures for Replacing Lead Goosenecks, Pigtails, or Connectors.

(a) The water system must replace any lead gooseneck, pigtail, or connector it owns when encountered during planned or unplanned water system infrastructure work.

(b) The water system must offer to replace a customer-owned lead gooseneck, pigtail, or connector; however, the water system is not required to bear the cost of replacement of the customer-owned parts.

(c) The water system is not required to replace a customer-owned lead gooseneck, pigtail, or connector if the customer objects to its replacement.

(d) The replacement of a lead gooseneck, pigtail, or connector does not count for the purposes of meeting the requirements for goal-based or mandatory lead service line replacements, in accordance with paragraphs (6) and (7) of this section, respectively.

(e) Upon replacement of any gooseneck, pigtail, or connector that is attached to a lead service line, the water system must follow risk mitigation procedures specified in R.61-58.11.G(6)(b).

(f) The requirements of paragraphs (3)(a), (b), (c), and (e) of this section do not apply if state law includes lead connectors in the definition of lead service lines, prohibits partial lead service line replacements, and requires systems to remove all lead service lines irrespective of a system's 90th percentile lead level.

(4) Requirements for Conducting Lead Service Line Replacement that may Result in Partial Replacement.

(a) Any water system that plans to partially replace a lead service line (e.g., replace only the portion of a lead service line that it owns) in coordination with planned infrastructure work must provide notice to the owner of the affected service line, or the owner's authorized agent, as well as non-owner resident(s) served by the affected service line at least forty-five (45) days prior to the replacement. The notice must explain that the system will replace the portion of the line it owns and offer to replace the portion of the service line not owned by the water system. The water system is not required to bear the cost of replacement of the portion of the affected service line not owned by the water system.

(i) Before the affected service line is returned to service, the water system must provide notification meeting the content requirements of R.61-58.11.G(1) explaining that consumers may experience a temporary increase of lead levels in their drinking water due to the replacement, information about the health effects of lead, and actions consumers can take to minimize their exposure to lead in drinking water. In instances where multi-family dwellings are served by the affected service line to be partially replaced, the water system may elect to post the information at a conspicuous location instead of providing individual notification to all residents.

(ii) The water system must provide information about service line flushing in accordance with the procedure developed in paragraph (2)(e) of this section before the affected service line is returned to service.

(iii) The water system must provide the consumer with a pitcher filter or point-of-use device certified by an American National Standards Institute accredited certifier to reduce lead, six (6) months of replacement cartridges, and instructions for use before the affected service line is returned to service. If the affected service line serves more than one (1) residence or non-residential unit (e.g., a multi-unit building), the water system must provide a filter, six (6) months of replacement cartridges, and use instructions to every residence in the building.

(iv) The water system must offer to collect a follow-up tap sample between three (3) months and six (6) months after completion of any partial replacement of a lead service line. The water system must provide the results of the sample in accordance with R.61-58.11.G(4).

(b) Any water system that replaces the portion of the lead service line it owns due to an emergency repair, must provide notice and risk mitigation measures to the persons served by the affected service line in accordance with paragraphs (4)(a)(i) through (iii) of this section before the affected service line is returned to service.

(c) When a water system is notified by the customer that the customer's portion of the lead service line will be replaced, the water system must make a good faith effort to coordinate simultaneous replacement of its portion of the service line. If simultaneous replacement cannot be conducted, the water system must replace its portion as soon as practicable but no later than forty-five (45) days from the date the customer replaces its portion of the lead service line. The water system must provide notification and risk mitigation measure in accordance with paragraphs (4)(a)(i) through (iii) of this section. If the water system fails to replace its portion of the lead service line within forty-five (45) days from the date the customer replaces the customer's portion of the lead service line, the water system must notify the Department within thirty (30) days of failing to meet the deadline in

accordance with R.61–58.11.L(5) and complete the replacement no later than one hundred eighty (180) days of the date the customer replaces its portion.

(d) When a water system is notified or otherwise learns that replacement of a customer-owned lead service line has occurred within the previous six (6) months and left in place a system-owned lead service line, the water system must replace its portion within forty-five (45) days from the day of becoming aware of the customer replacement. The water system must provide notification and risk mitigation measures in accordance with paragraphs (4)(a)(i) through (iii) of this section within twenty-four (24) hours of becoming aware of the customer replacement. If the water system fails to replace its portion of the affected service line within forty-five (45) days of becoming aware of the customer replacement, it must notify the Department within thirty (30) days of failing to meet the deadline in accordance with R.61–58.11.L(5). The water system must complete the replacement no later than one hundred eighty (180) days after the date the customer replaces its portion.

(e) When a water system is notified or otherwise learns of a replacement of a customer-owned lead service line which has occurred more than six (6) months in the past, the water system is not required to complete the lead service line replacement of the system-owned portion under this paragraph (4)(e), however the system-owned portion must still be included in the calculation of a lead service line replacement rate under paragraph (1)(g) of this section.

(5) Requirements for Conducting Full Lead Service Line Replacement.

Any water system that conducts a full lead service line replacement must provide notice to the owner of the affected service line, or the owner's authorized agent, as well as non-owner resident(s) served by the affected service line within twenty-four (24) hours of completion of the replacement. The water system is not required to bear the cost of replacement of the portion of the lead service line not owned by the water system.

(a) The notification must meet the content requirements of R.61–58.11.G(1) explaining that consumers may experience a temporary increase of lead levels in their drinking water due to the replacement, information about the health effects of lead, and actions consumers can take to minimize their exposure to lead in drinking water. In instances where multi-family dwellings are served by the lead service line to be replaced, the water system may elect to post the information at a conspicuous location instead of providing individual notification to all residents.

(b) The water system must provide information about service line flushing in accordance with the procedure developed under paragraph (2)(e) of this section before the replaced service line is returned to service.

(c) The water system must provide the consumer with a pitcher filter or point-of-use device certified by an American National Standards Institute accredited certifier to reduce lead, six (6) months of replacement cartridges, and instructions for use before the replaced service line is returned to service. If the lead service line serves more than one (1) residence or non-residential unit (e.g., a multi-unit building), the water system must provide a filter, six (6) months of replacement cartridges, and use instructions to every residence in the building.

(d) The water system must offer to the consumer to take a follow-up tap sample between three (3) months and six (6) months after completion of any full replacement of a lead service line. The water system must provide the results of the sample to the consumer in accordance with paragraph (4) of this section.

(6) Goal-based Full Lead Service Line Replacement for Water Systems Whose 90th Percentile Lead Level is Above the Trigger Level but at or Below the Lead Action Level.

Water systems that serve more than 10,000 persons whose 90th percentile lead level from tap samples taken pursuant to R.61–58.11.H is above the lead trigger level but at or below the lead action level must conduct goal-based full lead service line replacement at a rate approved by the Department.

(a) The water system must calculate the number of full lead service line replacements it must conduct annually in accordance with paragraph (1)(g) of this section.

(b) Replacement of lead service lines must be conducted in accordance with the requirements of paragraph (4) or (5) of this section.

(c) Only full lead service line replacements count towards a water system's annual replacement goal. Partial lead service line replacements do not count towards the goal.

(d) The water system must provide information to customers with lead, galvanized requiring replacement, or lead status unknown service lines as required in R.61-58.11.G(7).

(e) Any water system that fails to meet its lead service line replacement goal must:

(i) Conduct public outreach activities pursuant to R.61-58.11.G(8) until either the water system meets its replacement goal, or tap sampling shows the 90th percentile of lead is at or below the trigger level for two (2) consecutive one (1)-year monitoring periods.

(ii) Recomence its goal-based lead service line replacement program pursuant to this paragraph (6)(e)(ii) if the 90th percentile lead level anytime thereafter exceeds the lead trigger level but is at or below the lead action level.

(f) The first year of lead service line replacement shall begin on the first day following the end of the tap sampling period in which the lead trigger level was exceeded. If sampling is required annually or less frequently, the end of the tap sampling monitoring period is September 30 of the calendar year in which the sampling occurs. If the Department has established an alternate monitoring period, then the end of the monitoring period will be the last day of that period.

(7) Mandatory Full Lead Service Line Replacement for Water Systems Whose 90th Percentile Lead Level Exceeds the Lead Action Level.

Water systems serving more than 10,000 persons that exceed the lead action level in tap samples taken pursuant to R.61-58.11.H must conduct mandatory full lead service line replacement at an average annual rate of at least three percent (3%), calculated on a two (2)-year rolling basis.

(a) The average annual number of full lead service line replacements must be calculated in accordance with paragraph (1)(g) of this section.

(b) Lead service line replacement must be conducted in accordance with the requirements of paragraphs (4) and (5) of this section.

(c) Only full lead service line replacement count towards a water system's mandatory replacement rate of at least three percent (3%) annually. Partial lead service line replacements do not count towards the mandatory replacement rate.

(d) Water systems must provide information to customers with lead, galvanized requiring replacement, or lead status unknown service lines consistent with R.61-58.11.G(7).

(e) Community water systems serving 10,000 or fewer persons and non-transient, non-community water systems for which the Department has approved or designated lead service line replacement as a compliance option must conduct lead service line replacement as described in R.61-58.11.O(1)(a). Replacement of lead service lines must be conducted in accordance with the requirements of paragraphs (4) and (5) of this section.

(f) A water system may cease mandatory lead service line replacement when it has conducted a cumulative percentage of replacements greater than or equal to three percent (3%), or other percentage specified in paragraph (7)(i) of this section, of the service lines specified in paragraph (1)(g) of this section multiplied by the number of years that elapsed from when the system most recently began mandatory lead service line replacement and the date on which the system's 90th percentile lead level, in accordance with R.61-58.11.B(3)(d), has been calculated to be at or below the lead action level during each of four (4) consecutive six (6)-month tap sampling monitoring periods. If tap samples collected in any such system thereafter exceed the lead action level, the system shall recommence mandatory lead service line replacement at the same two (2)-year rolling average rate, unless the Department has designated an alternate replacement rate under paragraph (7)(i) of this section.

(g) The water system may also cease mandatory lead service line replacement if the system has no remaining lead status unknown service lines in its inventory and obtains refusals to conduct full lead service line replacement or non-responses from every remaining customer in its distribution system served by either a full or partial lead service line, or a galvanized requiring replacement service line. For purposes of this paragraph (7)(g) and in accordance with R.61-58.11.L(5), a water system must provide documentation to the Department of customer refusals including a refusal signed by the customer, documentation of a verbal statement made by the customer refusing replacement, or

documentation of no response from the customer after the water system made a minimum of two (2) good faith attempts to reach the customer regarding full lead service line replacement. If the water system's 90th percentile exceeds the lead action level again, it must contact all customers served by a full or partial lead service line or a galvanized requiring replacement service line with an offer to replace the customer-owned portion. Nothing in this paragraph (7)(g) requires the water system to bear the cost of replacement of the customer-owned lead service line.

(h) The first year of lead service line replacement shall begin on the first day following the end of the tap sampling period in which lead action level was exceeded.

(i) The Department shall require a system to replace lead service lines on a shorter schedule than that required by this section, taking into account the number of lead service lines in the system, where the Department determines a shorter replacement schedule is feasible. The Department shall make this determination in writing and notify the system of its finding within six (6) months after the system is required to begin lead service line replacement under paragraph (7) of this section.

(8) Reporting to Demonstrate Compliance to Department.

To demonstrate compliance with paragraphs (1) through (7) of this section, a system shall report to the Department the information specified in R.61-58.11.L(5).

G. Public Education and Supplemental Monitoring and Mitigation Requirements.

All water systems must deliver a consumer notice of lead tap water monitoring results to persons served by the water system at sites that are sampled, as specified in paragraph (4) of this section. A water system with lead, galvanized requiring replacement, or lead status unknown service lines must deliver public education materials to persons with a lead, galvanized requiring replacement, or lead status unknown service line as specified in paragraphs (5) through (7) of this section. All community water systems must conduct annual outreach to local and state health agencies as outlined in paragraph (9) of this section. A community water system serving more than 10,000 persons that fails to meet its annual lead service line replacement goal as required under R.61-58.11.F(6) shall conduct outreach activities as specified in paragraph (8) of this section. A water system that exceeds the lead action level based on tap water samples collected in accordance with R.61-58.11.H shall deliver the public education materials contained in paragraph (1) of this section and in accordance with the requirements in paragraph (2) of this section. Water systems that exceed the lead action level shall offer to sample the tap water of any customer who requests it in accordance with paragraph (3) of this section. All small community water systems and non-transient, non-community water systems that elect to implement point-of-use (POU) devices under R.61-58.11.O must provide public education materials to inform users how to properly use POU devices in accordance with paragraph (10) of this section.

(1) Content of Written Public Education Materials.

(a) Community water systems and non-transient, non-community water systems. Water systems must include the following elements in printed material (e.g., brochures and pamphlets) in the same order as listed in paragraphs (1)(a)(i) through (vii) of this section. In addition, language in paragraphs (1)(a)(i), (ii), and (vi) of this section must be included in the materials, exactly as written, except for the text in brackets in paragraphs (1)(a)(i), (ii), and (vi) of this section for which the water system must include system-specific information. Any additional information presented by a water system must be consistent with the information in paragraphs (1)(a)(i) through (vii) of this section and be in plain language that can be understood by the general public. Water systems must submit all written public education materials to the Department prior to delivery. The Department may require the system to obtain approval of the content of written public materials prior to delivery. Water systems may change the mandatory language in paragraphs (1)(a)(i) and (ii) of this section only with Department approval.

(i) IMPORTANT INFORMATION ABOUT LEAD IN YOUR DRINKING WATER. [INSERT NAME OF WATER SYSTEM] found elevated levels of lead in drinking water in some homes/buildings. Lead can cause serious health problems, especially for pregnant women and young children. Please read this information closely to see what you can do to reduce lead in your drinking water.

(ii) Health effects of lead. Exposure to lead in drinking water can cause serious health effects in all age groups. Infants and children can have decreases in IQ and attention span. Lead exposure can lead to new learning and behavior problems or exacerbate existing learning and behavior

problems. The children of women who are exposed to lead before or during pregnancy can have increased risk of these adverse health effects. Adults can have increased risks of heart disease, high blood pressure, kidney, or nervous system problems.

(iii) Sources of Lead.

(A) Explain what lead is.

(B) Explain possible sources of lead in drinking water and how lead enters drinking water. Include information on homes/building plumbing materials and service lines that may contain lead.

(C) Discuss other important sources of lead exposure in addition to drinking water (e.g., paint).

(iv) Discuss the steps the consumer can take to reduce their exposure to lead in drinking water.

(A) Encourage running the water to flush out the lead.

(B) Explain concerns with using hot water from the tap and specifically caution against the use of hot water for preparing baby formula.

(C) Explain that boiling water does not reduce lead levels.

(D) Discuss other options consumers can take to reduce exposure to lead in drinking water, such as alternative sources or treatment of water.

(E) Suggest that parents have their child's blood tested for lead.

(v) Explain why there are elevated levels of lead in the system's drinking water (if known) and what the water system is doing to reduce the lead levels in homes/buildings in this area.

(vi) For more information, call us at [INSERT YOUR NUMBER] [(IF APPLICABLE)], or visit our Web site at [INSERT YOUR WEB SITE HERE]]. For more information on reducing lead exposure around your home/building and the health effects of lead, visit EPA's website at <http://www.epa.gov/lead> or contact your health care provider.

(vii) Information on lead service lines. For systems with lead service lines, discuss opportunities to replace lead service lines and explain how to access the service line inventory so the consumer can find out if they have a lead service line. Include information on programs that provide financing solutions to assist property owners with replacement of their portion of a lead service line, and a statement that the water system is required to replace its portion of a lead service line when the property owner notifies them they are replacing their portion of the lead service line.

(b) Community water systems. In addition to including the elements specified in paragraph (1)(a) of this section, community water systems must:

(i) Tell consumers how to get their water tested.

(ii) Discuss lead in plumbing components and the difference between low lead and lead free.

(2) Delivery of public education materials:

(a) For public water systems serving a large proportion of non-English speaking consumers, as determined by the Department, the public education material must contain information in the appropriate language(s) regarding the importance of the notice or contain a telephone number or address where persons served may contact the water system to obtain a translated copy of the public education materials or to request assistance in the appropriate language.

(b) A community water system that exceeds the lead action level on the basis of tap water samples collected in accordance with R.61-58.11.H and that is not already conducting public education tasks under this section, must conduct the public education tasks under this section within 60 days after the end of the tap sampling period in which the exceedance occurred:

(i) Deliver printed materials meeting the content requirements of paragraph (1) of this section to all bill paying customers.

(ii)(A) Contact customers who are most at risk by delivering education materials that meet the content requirements of paragraph (1) of this section to local public health agencies even if they are not located within the water system's service area, along with an informational notice that encourages distribution to all the organization's potentially affected customers or community water system's users. The water system must contact the local public health agencies directly by phone or

in person. The local public health agencies may provide a specific list of additional community based organizations serving target populations, which may include organizations outside the service area of the water system. If such lists are provided, systems must deliver education materials that meet the content requirements of paragraph (1) of this section to all organizations on the provided lists.

(B) Contact customers who are most at risk by delivering materials that meet the content requirements of paragraph (1) of this section to the following organizations listed in (2)(b)(ii)(B)(1) through (7) of this section that are located within the water system's service area, along with an information notice that encourages distribution to all the organization's potentially affected customers or community water system's users:

- (1) Schools, child care facilities, and school boards.
- (2) Women, Infants and Children (WIC) and Head Start Programs.
- (3) Public and private hospitals and medical clinics.
- (4) Pediatricians.
- (5) Family planning clinics.
- (6) Local welfare agencies.
- (7) Obstetricians-Gynecologists and Midwives.

(C) Make a good faith effort to locate the following organizations within the service area and deliver materials that meet the content requirements of paragraph (1) of this section to them, along with an informational notice that encourages distribution to all potentially affected customers or users. The good faith effort to contact at risk customers may include requesting a specific contact list of these organizations from the local public health agencies, even if the agencies are not located within the water system's service area:

- (1) Licensed childcare centers.
- (2) Public and private preschools.
- (3) Obstetricians Gynecologist and Midwives.

(iii) No less often than quarterly, provide information on or in each water bill as long as the system exceeds the action level for lead. The message on the water bill must include the following statement exactly as written except for the text in brackets for which the water system must include system-specific information: [INSERT NAME OF WATER SYSTEM] found high levels of lead in drinking water in some homes. Lead can cause serious health problems. For more information please call [INSERT NAME OF WATER SYSTEM] [or visit (INSERT YOUR WEB SITE HERE)]. The message or delivery mechanism can be modified in consultation with the Department; specifically, the Department may allow a separate mailing of public education materials to customers if the water system cannot place the information on water bills.

(iv) Post materials meeting the content requirements of paragraph (1) of this section on the water system's Web site if the system serves a population of greater than 100,000.

(v) Submit a press release to newspaper, television and radio stations.

(vi) In addition to paragraph 2(b)(i) through (v) of this section, systems must implement at least three activities from one or more categories listed below. The educational content and selection of these activities must be determined in consultation with the Department.

- (A) Public Service Announcements.
- (B) Paid advertisements.
- (C) Public Area Information Displays.
- (D) E mails to customers.
- (E) Public Meetings.
- (F) Household Deliveries.
- (G) Targeted Individual Customer Contact.
- (H) Direct material distribution to all multi family homes and institutions.
- (I) Other methods approved by the Department.

(vii) For systems that are required to conduct monitoring annually or less frequently, the end of the tap sampling period is September 30 of the calendar year in which the sampling occurs, or, if the Department has established an alternate tap sampling period, the last day of that period.

(c) As long as a community water system exceeds the action level, it must repeat the activities pursuant to paragraph (2)(b) of this section as described in paragraphs (2)(c)(i) through (iv) of this section.

(i) A community water system shall repeat the tasks contained in paragraphs (2)(b)(i), (ii) and (vi) of this section every 12 months.

(ii) A community water system shall repeat the tasks contained in paragraph (2)(b)(iii) of this section with each billing cycle.

(iii) A community water system serving a population greater than 100,000 shall post and retain material on a publicly accessible Web site pursuant to paragraph (2)(b)(iv) of this section.

(iv) The community water system shall repeat the task in paragraph (2)(b)(v) of this section twice every twelve (12) months on a schedule agreed upon with the Department. The Department can allow activities in paragraph (2)(b) of this section to extend beyond the sixty (60) day requirement if needed for implementation purposes on a case by case basis; however, this extension must be approved in writing by the Department in advance of the sixty (60) day deadline.

(d) Within sixty (60) days after the end of the tap sampling period in which the exceedance occurred (unless it already is repeating public education tasks pursuant to paragraph (2)(e) of this section), a non-transient non-community water system shall deliver the public education materials specified in paragraph (1) of this section as follows:

(i) Post informational posters on lead in drinking water in a public place or common area in each of the buildings served by the system; and

(ii) Distribute informational pamphlets and/or brochures on lead in drinking water to each person served by the non-transient non-community water system. The Department may allow the system to utilize electronic transmission in lieu of or combined with printed materials as long as it achieves at least the same coverage.

(iii) For systems that are required to conduct monitoring annually or less frequently, the end of the tap sampling period is September 30 of the calendar year in which the sampling occurs, or, if the Department has established an alternate tap sampling period, the last day of that period.

(e) A non-transient non-community water system shall repeat the tasks contained in paragraph (2)(d) of this section at least once during each calendar year in which the system exceeds the lead action level. The Department can allow activities in (2)(d) of this section to extend beyond the sixty (60) day requirement if needed for implementation purposes on a case-by-case basis; however, this extension must be approved in writing by the Department in advance of the sixty (60) day deadline.

(f) A water system may discontinue delivery of public education materials if the system is at or below the lead action level during the most recent six-month monitoring period conducted pursuant to R.61-58.11.H. Such a system shall recommence public education in accordance with this section if it subsequently exceeds the lead action level during any tap sampling period.

(g) A community water system may apply to the Department, in writing (unless the Department has waived the requirement for prior Department approval), to use only the text specified in paragraph (1)(a) of this section in lieu of the text in paragraphs (1)(a) and (1)(b) of this section and to perform the tasks listed in paragraphs (2)(d) and (2)(e) of this section in lieu of the tasks in paragraphs (2)(b) and (2)(c) of this section if:

(i) The system is a facility, such as a prison or a hospital, where the population served is not capable of or is prevented from making improvements to plumbing or installing point of use treatment devices; and

(ii) The system provides water as part of the cost of services provided and does not separately charge for water consumption.

(h) A community water system serving 3,300 or fewer people may limit certain aspects of their public education programs as follows:

(i) With respect to the requirements of paragraph (2)(b)(vi) of this section, a system serving 3,300 or fewer people must implement at least one of the activities listed in that paragraph.

(ii) With respect to the requirements of paragraph (2)(b)(ii) of this section, a system serving 3,300 or fewer people may limit the distribution of the public education materials required under that paragraph to facilities and organizations served by the system that are most likely to be visited regularly by pregnant women and children.

(iii) With respect to the requirements of paragraph (2)(b)(v) of this section, the Department may waive this requirement for systems serving 3,300 or fewer persons as long as the system distributes notices to every household served by the system.

(3) Supplemental monitoring and notification of results.

A water system that fails to meet the lead action level on the basis of tap samples collected in accordance with R.61-58.11.H shall offer to sample the tap water of any customer who requests it. The system is not required to pay for collecting or analyzing the sample, nor is the system required to collect and analyze the sample itself.

(4) Notification of results.

(a) Reporting requirements. All water systems must provide a notice of the individual tap results from lead tap water monitoring carried out under the requirements of R.61-58.11.H to the persons served by the water system at the specific sampling site from which the sample was taken (e.g., the occupants of the building where the tap was sampled).

(b) Timing of notification. A water system must provide the consumer notice as soon as practical, but no later than the following timeframes.

(i) For individual samples that do not exceed fifteen micrograms per liter (15 µg/L) of lead, no later than thirty (30) days after the water system learns of the tap monitoring results.

(ii) For individual samples that exceed fifteen micrograms per liter (15 µg/L) of lead, as soon as practicable but no later than three (3) calendar days after the water system learns of the tap monitoring results. Water systems that choose to mail the notification must assure those letters are postmarked within three (3) days.

(c) Content. The consumer notice must include the results of lead tap water monitoring for the tap that was tested, an explanation of the health effects of lead, list steps consumers can take to reduce exposure to lead in drinking water and contact information for the water utility. The notice must also provide the maximum contaminant level goal and the action level for lead and the definitions for these two terms from R.61-58.12.C(3).

(d) Delivery.

(i) For lead tap sample results that do not exceed fifteen micrograms per liter (15 µg/L), the water systems must provide consumer notice to persons served at the tap that was sampled, by mail or by another method approved by the Department. For example, upon approval by the Department, a non-transient, non-community water system could post the results on a bulletin board in the facility to allow users to review the information.

(ii) For lead tap sample results that exceed fifteen micrograms per liter (15 µg/L), the water systems must provide consumer notice to persons served by the tap that was sampled; such notice must be provided electronically or by phone, hand delivery, by mail, or another method approved by the Department.

(5) Notification of Known or Potential Service Line Containing Lead

(a) Notification requirements. All water systems with lead, galvanized requiring replacement, or lead status unknown service lines in their inventory pursuant to R.61-58.11.F(1) must inform all persons served by the water system at the service connection with a lead, galvanized requiring replacement, or lead status unknown service line.

(b) Timing of notification. A water system must provide the initial notification within thirty (30) days of completion of the lead service line inventory required under R.61-58.11.F and repeat the notification on an annual basis until the entire service connection is no longer a lead, galvanized requiring replacement, or lead status unknown service line. For new customers, water systems shall also provide the notice at the time of service initiation.

(c) Content

(i) Persons served by a confirmed lead service line. The notice must include a statement that the person's service line is lead, an explanation of the health effects of lead that meets the requirements of paragraph (1)(a)(ii) of this section, steps persons at the service connection can take to reduce exposure to lead in drinking water, information about opportunities to replace lead service lines as well as programs that provide financing solutions to assist property owners with replacement of their portion of a lead service line, and a statement that the water system is required to replace its portion of a lead service line when the property owner notifies them they are replacing their portion of the lead service line.

(ii) Persons served by a galvanized requiring replacement service line. The notice must include a statement that the person's service line is galvanized requiring replacement, an explanation of the health effects of lead, steps persons at the service connection can take to reduce exposure to lead in drinking water, and information about opportunities for replacement of the service line.

(iii) Persons served by a lead status unknown service line. The notice must include a statement that the person's service line material is unknown but may be lead, an explanation of the health effects of lead that meets the requirements of paragraph (1)(a)(ii) of this section, steps persons at the service connection can take to reduce exposure to lead in drinking water, and information about opportunities to verify the material of the service line.

(d) Delivery. The notice must be provided to persons served by the water system at the service connection with a lead, galvanized requiring replacement, or lead status unknown service line, by mail or by another method approved by the Department.

(6) Notification Due to a Disturbance to a Known or Potential Service Line Containing Lead

(a) Water systems that cause disturbance to a lead, galvanized requiring replacement, or lead status unknown service line that results in the water to an individual service line being shut off or bypassed, such as operating a valve on a service line or meter setter, and without conducting a partial or full lead service line replacement, must provide the persons served by the water system at the service connection with information about the potential for elevated lead levels in drinking water as a result of the disturbance as well as instructions for a flushing procedure to remove particulate lead. The water system must comply with the requirements in this paragraph (6)(a) before the affected service line is returned to service.

(b) If the disturbance of a lead, galvanized requiring replacement, or lead status unknown service line results from the replacement of an inline water meter, a water meter setter, or gooseneck, pigtail, or connector, the water system must provide the person served by the water system at the service connection with information about the potential for elevated lead levels in drinking water as a result of the disturbance, public education materials that meet the content requirements in paragraph (1) of this section, a pitcher filter or point-of-use device certified by an American National Standards Institute accredited certifier to reduce lead, instructions to use the filter, and six (6) months of filter replacement cartridges. The water system must comply with the requirements of this paragraph (6)(b) before the affected service line is returned to service.

(c) A water system that conducts a partial or full lead service line replacement must follow procedures in accordance with the requirements in R.61-58.11.F(4)(a)(i) through (iv) and (5)(a)(i) through (iv), respectively.

(7) Information for Persons Served by Known or Potential Service Lines Containing Lead When a System Exceeds the Lead Trigger Level

(a) Content. All water systems with lead service lines that exceed the lead trigger level of ten micrograms per liter (10 µg/L) must provide persons served by the water system at the service connection with a lead, galvanized requiring replacement, or lead status unknown service line information regarding the water system's lead service line replacement program and opportunities for replacement of the lead service line.

(b) Timing. Water systems must send notification within thirty (30) days of the end of the tap sampling period in which the trigger level exceedance occurred. Water systems must repeat the notification annually until the results of sampling conducted under R.61-58.11.H are at or below the lead trigger level.

(c) Delivery. The notice must be provided to persons served at the service connection with a lead, galvanized requiring replacement, or lead status unknown service line, by mail or by another method approved by the Department.

(8) Outreach Activities for Failure to Meet the Lead Service Line Replacement Goal

(a) In the first year after a community water system that serves more than 10,000 persons does not meet its annual lead service line replacement goal as required under R.61-58.11.F(6), it must conduct one (1) outreach activity from the following list in the following year until the water system meets its replacement goal or until tap sampling shows that the 90th percentile for lead is at or below the trigger level of ten micrograms per liter (10 µg/L) for two (2) consecutive tap sampling monitoring periods:

(i) Send certified mail to customers with a lead or galvanized requiring replacement service line to inform them about the water system's goal-based lead service line replacement program and opportunities for replacement of the service line.

(ii) Conduct a townhall meeting.

(iii) Participate in a community event to provide information about its lead service line replacement program and distribute public education materials that meet the content requirements in paragraph (1) of this section.

(iv) Contact customers by phone, text message, email, or door hanger.

(v) Use another method approved by the Department to discuss the lead service line replacement program and opportunities for lead service line replacement.

(b) After the first year following a trigger level exceedance, any water system that thereafter continues to fail to meet its lead service line replacement goal must conduct one (1) activity from paragraph (8)(a) of this section and two (2) additional outreach activities per year from the following list:

(i) Conduct social media campaign.

(ii) Conduct outreach via newspaper, television, or radio.

(iii) Contact organizations representing plumbers and contractors by mail to provide information about lead in drinking water including health effects, sources of lead, and the importance of using leadfree plumbing materials.

(iv) Visit targeted customers to discuss the lead service line replacement program and opportunities for replacement.

(c) The water system may cease outreach activities when tap sampling shows that the 90th percentile for lead is at or below the trigger level of ten micrograms per liter (10 µg/L) for two (2) consecutive tap sampling monitoring periods or when all customer-side lead or galvanized requiring replacement service line owners refuse to participate in the lead service line replacement program. For purposes of this paragraph (8)(c), a refusal includes a signed statement by the customer refusing lead service line replacement, or documentation by the water system of a verbal refusal or of no response after two (2) good faith attempts to reach the customer.

(9) Public Education to Local and State Health Agencies

(a) Find-and-fix results. All community water systems must provide information to local and state health agencies about find-and-fix activities conducted in accordance with R.61-58.11.D(10), including the location of the tap sample site that exceeded fifteen micrograms per liter (15 µg/L), the result of the initial tap sample, the result of the follow-up tap sample, the result of water quality parameter monitoring, and any distribution system management actions or corrosion control treatment adjustments made.

(b) Timing and content. Community water systems must annually send copies of the public education materials provided under paragraph (1) of this section, and of paragraph (8)(a) of this section for actions conducted in the previous calendar year no later than July 1 of the following year.

(c) Delivery. Community water systems shall send public education materials and find-and-fix information to local and state health agencies by mail or by another method approved by the Department.

(10) Public Education Requirements for Small Water System Compliance Flexibility POU Devices

(a) Content. All small community water systems and non-transient non-community water systems that elect to implement POU devices under R.61–58.11.O must provide public education materials to inform users how to properly use POU devices to maximize the units’ effectiveness in reducing lead levels in drinking water.

(b) Timing. Water systems shall provide the public education materials at the time of POU device delivery.

(c) Delivery. Water systems shall provide the public education materials in person, by mail, or by another method approved by the Department, to persons at locations where the system has delivered POU devices.

H. Monitoring Requirements for Lead and Copper in Tap Water.

(1) Sample Site Location

(a) By the applicable date for commencement of monitoring under paragraph (4)(a) of this section, each water system shall identify a pool of targeted sampling sites based on the service line inventory conducted in accordance with R.61–58.11.F(1), that meet the requirements of this section, and which is sufficiently large enough to ensure that the water system can collect the number of lead and copper tap samples required in paragraph (3) of this section. Sampling sites may not include sites with installed point-of-entry (POE) treatment devices and taps used at sampling sites may not have point-of-use (POU) devices designed to remove inorganic contaminants, except for water systems monitoring under R.61–58.11.O(1)(c)(iv) and water systems using these devices for the primary drinking water tap to meet other primary and secondary drinking water standards and all service connections have POEs or POU’s to provide localized treatment for compliance with the other drinking water standards. Lead and copper sampling results for systems monitoring under R.61–58.11.O(1)(c)(iv) may not be used for the purposes of meeting the criteria for reduced monitoring specified in paragraph (4)(d) of this section.

(b) A water system must use the information on lead, copper, and galvanized iron or steel that it is required to be identified under R.61–58.5.V when conducting a materials evaluation and the information on lead service lines that is required to be collected under R.61–58.11.F(1) to identify potential lead service line sampling sites.

(c) The sampling sites selected for a community water system’s sampling pool must consist of single-family structures that are served by a lead service line (“Tier 1 sampling sites”). When multiple-family residences comprise at least twenty percent (20%) of the structures served by the water system, the system may include these types of structures in its Tier 1 sampling pool, if served by a lead service line. Sites with lead status unknown service lines must not be used as Tier 1 sampling sites.

(d) A community water system with insufficient Tier 1 sampling sites must complete its sampling pool with “Tier 2 sampling sites,” consisting of buildings, including multiple-family residences that are served by a lead service line. Sites with lead status unknown service lines must not be used as Tier 2 sampling sites.

(e) A community water system with insufficient Tier 1 and Tier 2 sampling sites must complete its sampling pool with “Tier 3 sampling sites,” consisting of single-family structures that contain galvanized lines identified as being downstream of a lead service line (LSL) currently or in the past, or known to be downstream of a lead gooseneck, pigtail, or connector. Sites with lead status unknown service lines must not be used as Tier 3 sampling sites.

(f) A community water system with insufficient Tier 1, Tier 2, and Tier 3 sampling sites must complete its sampling pool with “Tier 4 sampling sites,” consisting of single-family structures that contain copper pipes with lead solder installed before the effective date of the state’s applicable lead ban. Sites with lead status unknown service lines must not be used as Tier 4 sampling sites.

(g) A community water system with insufficient Tier 1, Tier 2, Tier 3, and Tier 4 sampling sites must complete its sampling pool with “Tier 5 sampling sites,” consisting of single-family structures or buildings, including multiple family residences that are representative of sites throughout the distribution system. For the purpose of this paragraph (1)(g), a representative site is a site in which the plumbing materials used at that site would be commonly found at other sites served by the water system. Water systems may use non-residential buildings that are representative of sites throughout

the distribution system if and only if there are an insufficient number of single-family or multiple family residential Tier 5 sites available.

(h) The sampling sites selected for a non-transient, non-community water system must consist of sites that are served by a lead service line (“Tier 1 sampling sites”). Sites with lead status unknown service lines must not be used as Tier 1 sampling sites.

(i) A non-transient, non-community water system with insufficient Tier 1 sites complete its sampling pool with “Tier 3 sampling sites,” consisting of sampling sites that contain galvanized lines identified as being downstream of an LSL currently or in the past, or known to be downstream of a lead gooseneck, pigtail, or connector. Sites with lead status unknown service lines must not be used as Tier 3 sampling sites.

(j) A non-transient, non-community water system with insufficient Tier 1 and Tier 3 sampling sites must complete its sampling pool with “Tier 5 sampling sites,” consisting of sampling sites that are representative of sites throughout the distribution system. For the purpose of this paragraph (1)(j), a representative site is a site in which the plumbing materials used at that site would be commonly found at other sites served by the water system.

(k) A water system whose distribution system contains lead service lines must collect all samples for monitoring under this section from sites served by a lead service line. A water system that cannot identify a sufficient number of sampling sites served by lead service lines must still collect samples from every site served by a lead service line, and collect the remaining samples in accordance with tiering requirements under paragraphs (1)(e) through (g) or paragraphs (1)(i) through (j) of this section.

(2) Sample Collection Methods

(a) All tap samples for lead and copper collected in accordance with this section, with the exception of fifth liter samples collected under paragraph (2)(c) of this section, and samples collected under paragraphs (2)(e) and (8) of this section, must be first-draw samples. The first-draw sample shall be analyzed for lead and copper in tap sampling periods where both contaminants are required to be monitored. In tap sampling periods where only lead is required to be monitored, the first-draw sample may be analyzed for lead only.

(b) Each first-draw tap sample for lead and copper shall be one liter (1 L) in volume and have stood motionless in the plumbing system of each sampling site for at least six (6) hours. Bottles used to collect first-draw samples must be wide-mouth one-liter sample bottles. First-draw samples from residential housing must be collected from the cold water kitchen or bathroom sink tap. First-draw samples from a nonresidential building shall be one liter in volume and collected at a tap from which water is typically drawn for consumption. Department-approved non-first-draw samples collected in lieu of first-draw samples pursuant to paragraph (2)(e) of this section must be one liter (1 L) in volume and must be collected at an interior tap from which water is typically drawn for consumption. First-draw samples may be collected by the system or the system may allow residents to collect first-draw samples after instructing the residents of the sampling procedures specified in this paragraph (2)(b). Sampling instructions provided to residents must not include instructions for aerator removal and cleaning or flushing of taps prior to the start of the minimum six (6)-hour stagnation period. To avoid problems of residents handling nitric acid, acidification of first-draw samples may be done up to fourteen (14) days after the sample is collected. After acidification to resolubilize the metals, the sample must stand in the original container for the time specified in the approved EPA method before the sample can be analyzed. If a system allows residents to perform sampling, the system may not challenge, based on alleged errors in sample collection, the accuracy of sampling results.

(c)(i) All tap samples for copper collected at sites with a lead service line shall be the first-draw sample collected using the procedure listed in this paragraph (2)(c). Tap samples for copper are required to be collected and analyzed only in monitoring periods for which copper monitoring is required.

(ii) Systems must collect tap water in five (5) consecutively numbered one-liter (1 L) sample bottles after the water has stood motionless in the plumbing of each sampling site for at least six (6) hours without flushing the tap prior to sample collection. Systems must analyze first-draw samples for copper, when applicable, and fifth liter samples for lead. Bottles used to collect these

samples must be wide-mouth one-liter (1 L) sample bottles. Systems must collect first-draw samples in the first sample bottle with each subsequently numbered bottle being filled until the final bottle is filled with the water running constantly during sample collection. Fifth liter sample is the final sample collected in this sequence. System must collect first-draw and fifth liter samples from residential housing from the cold water kitchen or bathroom sink tap. First-draw and fifth liter samples from a nonresidential building must be one liter (1 L) in volume and collected at an interior cold water tap from which water is typically drawn for consumption. First-draw and fifth liter samples may be collected by the system or the system may allow residents to collect first-draw samples and fifth liter samples after instructing the residents on the sampling procedures specified in this paragraph (2)(c)(ii). Sampling instructions provided to customers must not direct the customer to remove the aerator or clean or flush the taps prior to the start of the minimum six (6)-hour stagnation period. To avoid problems of residents handling nitric acid, the system may acidify first-draw samples up to fourteen (14) days after the sample is collected. After acidification to resolubilize the metals, the sample must stand in the original container for the time specified in the approved EPA method before the sample can be analyzed. If a system allows residents to perform sampling, the system may not challenge, based on alleged errors in sample collection, the accuracy of sampling results.

(d) A water system must collect each first-draw tap sample from the same sampling site from which it collected the previous sample. A water system must collect each fifth liter sample from the same sampling site from which it collected the previous sample. If, for reasons beyond the control of the water system, the water system cannot gain entry to a sampling site in order to collect a follow-up tap sample, the system may collect the follow-up tap sample from another sampling site in its sampling pool as long as the new site meets the same targeting criteria, and is within reasonable proximity of the original site.

(e) A non-transient, non-community water system, or a community water system that meets the criteria of R.61-58.11.G(2)(g), that does not have enough taps that can supply first-draw samples or fifth liter samples meeting the six (6)-hour minimum stagnation time, as defined in R.61-58(B), may apply to the Department in writing to substitute non-first-draw samples, first-draw, or fifth liter samples that do not meet the six (6)-hour minimum stagnation time. Such systems must collect as many first-draw or fifth liter samples from interior taps typically used for consumption as possible and must identify sampling times and locations that would likely result in the longest standing time for the remaining sites. The Department has the discretion to waive the requirement for prior Department approval of sites not meeting the six (6)-hour stagnation time either through State regulation or written notification to the system.

(3) Number of Samples - Water systems shall collect at least one (1) sample during each monitoring period specified in paragraph (4) of this section from the number of sites listed in the first column ("standard monitoring") of the table in this paragraph. A system conducting reduced monitoring under paragraph (4)(d) of this section shall collect at least one (1) sample from the number of sites specified in the second column ("reduced monitoring") of the table in this paragraph during each monitoring period specified in paragraph (4)(d) of this section. Such reduced monitoring sites shall be representative of the sites required for standard monitoring. A public water system that has fewer than five drinking water taps, that can be used for human consumption meeting the sample site criteria of paragraph (1) of this section to reach the required number of sample sites listed in paragraph (3) of this section, must collect at least one sample from each tap and then must collect additional samples from those taps on different days during the monitoring period to meet the required number of sites. Alternatively, the Department may allow these public water systems to collect a number of samples less than the number of sites specified in paragraph (3) of this section, provided that one hundred (100) percent of all taps that can be used for human consumption are sampled. The Department must approve this reduction of the minimum number of samples in writing based on a request from the system or onsite verification by the Department. The Department may specify sampling locations when a system is conducting reduced monitoring. The table is as follows:

System Size (# People Served)	# of Sites (Standard Monitoring)	# of Sites (Reduced Monitoring)
>100,000	100	50

10,001 to 100,000	60	30
3,301 to 10,000	40	20
501 to 3,300	20	10
101 to 500	10	5
<= 100	5	5

(4) Timing of Monitoring

(a) Standard monitoring. Standard monitoring is a six (6)-month tap sampling monitoring period that begins on January 1 or July 1 of the year in which the water system is monitoring at the standard number of sites in accordance to paragraph (3) of this section.

(i) All water systems with lead service lines, including those deemed optimized under R.61–58.11.C(2)(c), and systems that did not conduct monitoring that meets all requirements of this section (e.g., sites selected in accordance with paragraph (1) of this section, samples collected in accordance with paragraph (2) of this section, etc.) between January 15, 2021, and January 16, 2024, must begin the first standard monitoring period on January 1 or July 1 in the year following the January 16, 2024, whichever is sooner. Upon completion of this monitoring, systems must monitor in accordance with paragraph (4)(a)(ii) of this section.

(ii) Systems that conducted monitoring that meet all requirements of this section (e.g., sites selected in accordance with paragraph (1) of this section, samples collected in accordance with paragraph (2) of this section, etc.) between January 15, 2021, and January 16, 2024, and systems that have completed monitoring under paragraph (4)(a)(i) of this section, must continue monitoring as follows:

(A) Systems that do not meet the criteria under paragraph (4)(d) of the section must conduct standard monitoring.

(B) Systems that meet the criteria under paragraph (4)(d) of this section must continue to monitor in accordance with the criteria in paragraph (4)(d).

(C) Any system monitoring at a reduced frequency in accordance with paragraph (4)(d) of this section that exceeds an action level must resume standard monitoring beginning January 1 of the calendar year following the tap sampling monitoring period in which the system exceeded the action level. Any such system must also monitor in accordance with R.61–58.11.I(2), (3), or (4) as applicable.

(D) Any system monitoring at a reduced frequency that exceeds the lead trigger level but meets the copper action level must not monitor any less frequently than annually and must collect samples from the standard number of sites as established in paragraph (3) of this section. This monitoring must begin the calendar year following the tap sampling monitoring period in which the system exceeded the action level. Any such system must also monitor in accordance with R.61–58.11.I(2), (3), or (4) as applicable.

(E) Any system that fails to operate at or above the minimum value or within the range of values for the water quality parameters specified by the Department under R.61–58.11.D(6) for more than nine (9) days in any monitoring period specified in R.61–58.11.I must conduct standard tap water monitoring and must resume sampling for water quality parameters in accordance with R.61–58.11.I(4). This standard monitoring must begin no later than the six (6)-month period beginning January 1 of the calendar year following the water quality parameter excursion.

(F) Any water system that becomes a large water system without corrosion control treatment or any large water system without corrosion control treatment whose lead 90th percentile exceeds the lead practical quantitation level must conduct standard monitoring for at least two (2) consecutive six (6)-month tap sampling monitoring periods and then must continue monitoring in accordance with this paragraph (4)(a)(ii)(F).

(b) Monitoring After Installation of Initial or Re-Optimized Corrosion Control Treatment and Addition of New Source or Change in Treatment

(i) Any water system that installs or re-optimizes corrosion control treatment, as a result of exceeding the lead or copper action level, must monitor for lead and copper every six (6) months and comply with previously designated water quality parameter values, where applicable, until the Department specifies new water quality parameter values for optimal corrosion control.

(ii) Any water system that reoptimizes corrosion control treatment as a result of exceeding the lead trigger level but has not exceeded the lead or copper action level must monitor annually for lead at the standard number of sites listed in paragraph (3) of this section. Samples shall be analyzed for copper on a triennial basis. Small and medium-size systems that do not exceed the lead trigger level in three (3) annual monitoring periods may reduce lead monitoring in accordance with paragraph (4)(d) of this section.

(iii) Any water system that installs source water treatment pursuant to R.61-58.11.E(1)(c) must monitor every six (6) months until the system is at or below lead and copper action levels for two (2) consecutive six (6)-month monitoring periods. Systems that do not exceed the lead or copper action level for two (2) consecutive six (6)-month monitoring periods may reduce monitoring in accordance with paragraph (4)(d) of this section.

(iv) If a water system has notified the Department in writing in accordance with R.61-58.11.L(1)(c) of an upcoming addition of a new source or long-term change in treatment, the water system shall monitor every six (6) months at the standard number of sites listed under paragraph (3) of this section until the system is at or below the lead and copper action levels for two (2) consecutive six (6)-month monitoring periods, unless the Department determines that the addition of the new source or long-term change in treatment is not significant and, therefore, does not warrant more frequent monitoring. Systems that do not exceed the lead and copper action levels, and/or the lead trigger level for two (2) consecutive six (6)-month monitoring periods may reduce monitoring in accordance with paragraph (4)(d) of this section.

(c) Monitoring After the Department Specifies Water Quality Parameter Values for Optimal Corrosion Control Treatment

(i) After the Department specifies the values for water quality control parameters under R.61-58.11.D(6), the system must conduct standard six (6)-month monitoring for two (2) consecutive six (6)-month tap sampling monitoring periods. Systems may then reduce monitoring in accordance with paragraph (4)(d) of this section as applicable, following a Department determination that reduced monitoring is approved.

(ii) Systems required to complete the re-optimization steps in R.61-58.11.C(4) due to the exceedance of the lead trigger level that do not exceed the lead and copper action levels must monitor for two (2) consecutive six (6)-month tap sampling monitoring periods. Systems may then reduce monitoring in accordance with paragraph (4)(d) of this section as applicable following a Department determination that reduced monitoring is approved.

(d) Reduced Monitoring Based on 90th Percentile Levels

Reduced monitoring refers to an annual or triennial tap sampling monitoring period. The reduced monitoring frequency is based on the 90th percentile value for the water system.

(i) A water system that meets the criteria for reduced monitoring under paragraph (4)(d) of this section must collect these samples from sampling sites identified in paragraph (1) of this section. Systems monitoring annually or less frequently must conduct the lead and copper tap sampling during the months of June, July, August, or September unless the Department has approved a different sampling period in accordance with paragraph (4)(d)(i)(A) of this section.

(A) The Department, at its discretion, may approve a different tap sampling period for conducting the lead and copper tap sampling for systems collecting samples at a reduced frequency. Such a period must be no longer than four (4) consecutive months, within one (1) calendar year, and must represent a time of normal operation where the highest levels of lead are most likely to occur. For a non-transient, non-community water system that does not operate during the months of June through September and for which the period of normal operation where the highest levels of lead are most likely to occur is not known, the Department must designate a period that represents normal operation for the system. This monitoring must begin

during the period approved or designated by the Department in the calendar year immediately following the end of the second six (6)-month monitoring period for systems initiating annual monitoring and during the three (3)-year period following the end of the third consecutive year of annual monitoring for systems initiating triennial monitoring.

(B) Systems monitoring annually that have been collecting samples during the months of June through September and that receive Department approval to alter their tap sampling monitoring period under paragraph (4)(d)(i)(A) of this section must collect their next round of samples during a time period that ends no later than twenty-one (21) months after the previous round of sampling. Systems monitoring triennially that have been collecting samples during the month of June through September and receive Department approval to alter their sampling collection period as per paragraph (4)(d)(i)(A) of this section must collect their next round of samples during a time period that ends no later than forty-five (45) months after the previous tap sampling period. Subsequent monitoring must be conducted annually or triennially, as required by this section.

(C) Small systems with waivers granted pursuant to paragraph (7) of this section that have been collecting samples during the months of June through September and receive Department approval to alter their tap sampling period as per paragraph (4)(d)(i)(A) of this section must collect their next round of samples before the end of the nine (9)-year period.

(ii) Any water system that meets the lead trigger level and the copper action level, during each of two (2) consecutive six (6)-month tap sampling monitoring periods may reduce the monitoring frequency to annual monitoring and must sample at the standard number of sampling sites for lead and the reduced number of sites for copper in accordance with paragraph (3) of this section. Systems operating under optimal corrosion control treatment (OCCT) must also have maintained the range of optimal water quality parameters (OWQPs) set by the Department in accordance with R.61-58.11.D(6) for the same period and receive a written determination from the Department approving annual monitoring based on the Department's review of monitoring, treatment, and other relevant information submitted by the system as required by R.61-58.11.L. This sampling must begin no later than the calendar year immediately following the last calendar year in which the system sampled.

(iii) Any water system that exceeds the lead trigger level but not the lead and copper action levels during two (2) consecutive six (6)-month tap sampling monitoring periods must monitor no less frequently than annually at the standard number of sampling sites for lead and copper specified in paragraph (3) of this section. Systems operating OCCT must also have maintained the range of OWQPs set by the Department in accordance with R.61-58.11.D(6) for the same period of six (6)-month monitoring and receive a written determination from the Department approving annual monitoring based on the Department's review of monitoring, treatment, and other relevant information submitted by the system as required by R.61-58.11.L. This sampling must begin no later than the calendar year immediately following the last calendar year in which the system sampled.

(iv) Any water system that exceeds the lead trigger level but not the lead and copper action levels during three (3) consecutive years of monitoring may reduce the tap sampling monitoring period for copper to once every three (3) years; however, the system may not reduce the tap sampling monitoring period for lead. Systems operating OCCT must also maintain the range of OWQPs set by the Department in accordance with R.61-58.11.D(6) and receive a written determination from the Department approving triennial monitoring based on the Department's review of monitoring, treatment, and other relevant information submitted by the system as required by R.61-58.11.L. This sampling must begin no later than the third calendar year immediately following the last calendar year in which the system sampled.

(v) Any small or medium-size system that does not exceed the lead trigger level and the copper action level during three (3) consecutive years of monitoring (standard monitoring completed during both six (6)-month periods of a calendar year shall be considered one (1) year of monitoring) may sample at the reduced number of sites for lead and copper in accordance with paragraph (3) of this section and reduce the monitoring frequency to triennial monitoring. Systems operating OCCT must also have maintained the range of OWQPs set by the Department in accordance with R.61-58.11.D(6) for the same three (3)-year period and receive a written

determination from the Department approving triennial monitoring based on the Department's review of monitoring, treatment, and other relevant information submitted by the system as required by R.61-58.11.L. This sampling must begin no later than three (3) calendar years after the last calendar year in which the system sampled.

(vi) Any water system that demonstrates for two (2) consecutive six (6)- month monitoring periods that its 90th percentile lead level, calculated under R.61-58.11.B(3)(d), is less than or equal to 0.005 mg/L and the 90th percentile copper level, calculated under R.61-58.11.B(3)(d), is less than or equal to 0.65 mg/L may sample at the reduced number of sites for lead and copper in accordance with paragraph (3) of this section and reduce the frequency of monitoring to triennial monitoring. For water systems with corrosion control treatment, the system must maintain the range of values for the water quality parameters reflecting OCCT specified by the Department under R.61-58.11.D(6) to qualify for reduced monitoring pursuant to this paragraph (4)(d)(vi).

(5) Additional Monitoring by Systems - The results of any monitoring conducted in addition to the minimum requirements of this section (such as customer-requested sampling) shall be considered by the water system and the Department in making any determinations (i.e., calculating the 90th percentile lead or copper level) under this section. Water systems with lead service lines that are unable to collect the minimum number of samples from Tier 1 or Tier 2 sites shall calculate the 90th percentile using data from all the lead service line sites and the highest lead and copper values from lower tier sites to meet the specified minimum number of samples. Systems must submit data from additional Tier 3, Tier 4, or Tier 5 sites to the Department but may not use these results in the 90th percentile calculation. Water systems must include customer-requested samples from known lead service line sites in the 90th percentile calculation if the samples meet the requirements of this section.

(6) Invalidation of Lead and Copper Tap Samples used in the Calculation of the 90th Percentile. A sample invalidated under this paragraph (6) does not count toward determining lead or copper 90th percentile levels under R.61-58.11.B(1)(c), or toward meeting the minimum monitoring requirements of paragraph (3) of this section.

(a) The Department may invalidate a lead or copper tap water sample at least if one of the following conditions is met.

(i) The laboratory establishes that improper sample analysis caused erroneous results.

(ii) The Department determines that the sample was taken from a site that did not meet the site selection criteria of this section.

(iii) The sample container was damaged in transit.

(iv) There is substantial reason to believe that the sample was subject to tampering.

(b) The system must report the results of all samples to the Department and all supporting documentation for samples the system believes should be invalidated.

(c) To invalidate a sample under paragraph (6)(a) of this section, the decision and the rationale for the decision must be documented in writing. The Department may not invalidate a sample solely on the grounds that a follow-up sample result is higher or lower than that of the original sample.

(d) The water system must collect replacement samples for any samples invalidated under this section if, after the invalidation of one or more samples, the system has too few samples to meet the minimum requirements of paragraph (3) of this section. Any such replacement samples must be taken as soon as possible, but no later than 20 days after the date the Department invalidates the sample or by the end of the applicable monitoring period, whichever occurs later. Replacement samples taken after the end of the applicable monitoring period shall not also be used to meet the monitoring requirements of a subsequent monitoring period. The replacement samples shall be taken at the same locations as the invalidated samples or, if that is not possible, at locations other than those already used for sampling during the monitoring period.

(7) Monitoring Waivers for Systems Serving 3,300 or Fewer Persons.

Any water system serving 3,300 or fewer persons that meets the criteria of this paragraph (7) may apply to the Department to reduce the frequency of monitoring for lead and copper under this section to once every nine (9) years (i.e., a "full waiver") if it meets all of the materials criteria specified in paragraph (7)(a) of this section and all of the monitoring criteria specified in paragraph (7)(b) of this section. If state regulations permit, any water system serving 3,300 or fewer persons

that meets the criteria in paragraphs (7)(a) and (b) of this section only for lead, or only for copper, may apply to the Department for a waiver to reduce the frequency of tap water monitoring to once every nine (9) years for that contaminant only (i.e., a “partial waiver”).

(a) Materials criteria. The system must demonstrate that its distribution system and service lines and all drinking water supply plumbing, including plumbing conveying drinking water within all residences and buildings connected to the system, are free of lead-containing materials and/or copper-containing materials, as those terms are defined in this paragraph, as follows:

(i) Lead. To qualify for a full waiver, or a waiver of the tap water monitoring requirements for lead (i.e., a “lead waiver”), the water system must provide certification and supporting documentation to the Department that the system is free of all lead-containing materials, as follows:

(A) It contains no plastic pipes which contain lead plasticizers, or plastic service lines which contain lead plasticizers; and

(B) It is free of lead service lines, lead pipes, lead soldered pipe joints, and leaded brass or bronze alloy fittings and fixtures, unless such fittings and fixtures meet the specifications of any standard established pursuant to 42 U.S.C. 300g-6(e) (SDWA section 1417(e)).

(ii) Copper. To qualify for a full waiver, or a waiver of the tap water monitoring requirements for copper (i.e., a “copper waiver”), the water system must provide certification and supporting documentation to the Department that the system contains no copper pipes or copper service lines.

(b) Monitoring criteria for waiver issuance. The system must have completed at least one 6-month round of standard tap water monitoring for lead and copper at sites approved by the Department and from the number of sites required by paragraph (3) of this section and demonstrate that the 90th percentile levels for any and all rounds of monitoring conducted since the system became free of all lead-containing and/or copper-containing materials, as appropriate, meet the following criteria.

(i) Lead levels. To qualify for a full waiver, or a lead waiver, the system must demonstrate that the 90th percentile lead level does not exceed 0.005 mg/L.

(ii) Copper levels. To qualify for a full waiver, or a copper waiver, the system must demonstrate that the 90th percentile copper level does not exceed 0.65 mg/L.

(c) Department approval of waiver application. The Department shall notify the system of its waiver determination, in writing, setting forth the basis of its decision and any condition of the waiver. As a condition of the waiver, the Department may require the system to perform specific activities (e.g., limited monitoring, periodic outreach to customers to remind them to avoid installation of materials that might void the waiver) to avoid the risk of lead or copper concentration of concern in tap water. The small system must continue monitoring for lead and copper at the tap as required by paragraphs (4)(a) through (4)(d) of this section, as appropriate, until it receives written notification from the Department that the waiver has been approved.

(d) Monitoring frequency for systems with waivers.

(i) A system with a full waiver must conduct tap water monitoring for lead and copper in accordance with paragraph (4)(d)(iv) of this section at the reduced number of sampling sites identified in paragraph (3) of this section at least once every nine (9) years and provide the materials certification specified in paragraph (7)(a) of this section for both lead and copper to the Department along with the monitoring results. Samples collected every nine (9) years shall be collected no later than every ninth calendar year.

(ii) A system with a partial waiver must conduct tap water monitoring for the waived contaminant in accordance with paragraph (4)(d)(iv) of this section at the reduced number of sampling sites specified in paragraph (3) of this section at least once every nine (9) years and provide the materials certification specified in paragraph (7)(a) of this section pertaining to the waived contaminant along with the monitoring results. Such a system also must continue to monitor for the non-waived contaminant in accordance with requirements of paragraph (4)(a) through (4)(d) of this section, as appropriate.

(iii) Any water system with a full or partial waiver shall notify the Department in writing in accordance with R.61-58.11.L(1)(c) of any upcoming long-term change in treatment or addition of a new source, as described in that section. The Department must review and approve the addition

of a new source or long-term change in water treatment before it is implemented by the water system. The Department has the authority to require the system to add or modify waiver conditions (e.g., require recertification that the system is free of lead-containing and/or copper-containing materials, require additional round(s) of monitoring), if it deems such modifications are necessary to address treatment or source water changes at the system.

(iv) If a system with a full or partial waiver becomes aware that it is no longer free of lead-containing or copper-containing materials, as appropriate, (e.g., as a result of new construction or repairs), the system shall notify the Department in writing no later than sixty (60) days after becoming aware of such a change.

(e) Continued eligibility. If the system continues to satisfy the requirements of paragraph (7)(d) of this section, the waiver will be renewed automatically, unless any of the conditions listed in paragraph (7)(e)(i) through (7)(e)(iii) of this section occurs. A system whose waiver has been revoked may re-apply for a waiver at such time as it again meets the appropriate materials and monitoring criteria of paragraphs (7)(a) and (7)(b) of this section.

(i) A system with a full waiver or a lead waiver no longer satisfies the materials criteria of paragraph (7)(a)(i) of this section or has a 90th percentile lead level greater than 0.005 mg/L.

(ii) A system with a full waiver or a copper waiver no longer satisfies the materials criteria of paragraph (7)(a)(ii) of this section or has a 90th percentile copper level greater than 0.65 mg/L.

(iii) The Department notifies the system, in writing, that the waiver has been revoked, setting forth the basis of its decision.

(f) Requirements following waiver revocation. A system whose full or partial waiver has been revoked by the Department is subject to the corrosion control treatment and lead and copper tap water monitoring requirements, as follows:

(i) If the system exceeds the lead and/or copper action level, the system must implement corrosion control treatment in accordance with the deadlines specified in R.61-58.11.C(5), and any other applicable requirements of this section.

(ii) If the system meets both the lead and the copper action level, the system must monitor for lead and copper at the tap no less frequently than once every three years using the reduced number of sample sites specified in paragraph (3) of this section.

(g) Pre-existing waivers. Small system waivers approved by the Department in writing prior to April 11, 2000 shall remain in effect under the following conditions:

(i) If the system has demonstrated that it is both free of lead-containing and copper-containing materials, as required by paragraph (7)(a) of this section and that its 90th percentile lead levels and 90th percentile copper levels meet the criteria of paragraph (7)(b) of this section, the waiver remains in effect so long as the system continues to meet the waiver eligibility criteria of paragraph (7)(e) of this section. The first round of tap water monitoring conducted pursuant to paragraph (7)(d) of this section shall be completed no later than nine years after the last time the system has monitored for lead and copper at the tap.

(ii) If the system has met the materials criteria of paragraph (7)(a) of this section but has not met the monitoring criteria of paragraph (7)(b) of this section, the system shall conduct a round of monitoring for lead and copper at the tap demonstrating that it meets the criteria of paragraph (7)(b) of this section no later than September 30, 2000. Thereafter, the waiver shall remain in effect as long as the system meets the continued eligibility criteria of paragraph (7)(e) of this section. The first round of tap water monitoring conducted pursuant to paragraph (7)(d) of this section shall be completed no later than nine (9) years after the round of monitoring conducted pursuant to paragraph (7)(b) of this section.

(8) Follow-up Samples for "Find-and-fix" under R.61-58.11.D(10).

Systems shall collect a follow-up sample at any site that exceeds the action level within thirty (30) days of receiving the sample results. These follow-up samples may use different sample volumes or different sample collection procedures to assess the source of elevated lead. Systems shall submit samples collected under this section to the Department but shall not include such samples in the 90th percentile calculation.

(9) Public Availability of Tap Monitoring Results used in the 90th Percentile Calculation.

All water systems must make available to the public the results of compliance tap water monitoring data, including data used in the 90th percentile calculation under R.61–58.11.B(3)(d), within sixty (60) days of the end of the applicable tap sampling period. Nothing in this section requires water systems to make publicly available the addresses of the sites where the tap samples were collected. Large systems shall make available the monitoring results in a digital format. Small and medium-size systems shall make available the monitoring results in either a written or digital format. Water systems shall retain tap sampling monitoring data in accordance with recordkeeping requirements under R.61–58.11.M.

I. Monitoring Requirements for Water Quality Parameters.

All large water systems, and all small and medium-size systems that exceed the lead or copper action level, and all small and medium-size water systems with corrosion control treatment that exceed the lead trigger level must monitor water quality parameters in addition to lead and copper in accordance with this section.

(1) General Requirements

(a) Sample Collection Methods

(i) Tap samples shall be representative of water quality throughout the distribution system taking into account the number of persons served, the different sources of water, the different treatment methods employed by the system, and seasonal variability. Tap sampling under this section is not required to be conducted at taps targeted for lead and copper sampling under R.61–58.11.H(1). Sites selected for tap samples under this section must be included in the site sample plan specified under R.61–58.11.H(1)(a). The site sample plan must be updated prior to changes to the sampling locations. [Note: Systems may find it convenient to conduct tap sampling for water quality parameters at sites used for coliform sampling under R.61–58.5.G if they also meet the requirements of this section.]

(ii) Samples collected at the entry point(s) to the distribution system must be from locations representative of each source after treatment. If a system draws water from more than one source and the sources are combined before distribution, the system must sample at an entry point to the distribution system during periods of normal operating conditions (i.e., when water is representative of all sources being used).

(b) Number of Samples

(i) Systems must collect two (2) tap samples for applicable water quality parameters during each monitoring period specified under paragraphs (2) through (5) of this section from the minimum number of sites listed in table 1 to this paragraph (1)(b)(i). Systems that add sites as a result of the “find-and-fix” requirements in R.61–58.11.D(10) must collect tap samples for applicable water quality parameters during each monitoring period under paragraphs (2) through (5) of this section and must sample from that adjusted minimum number of sites. Systems are not required to add sites if they are monitoring at least twice the minimum number of sites list in table 1 to this paragraph (1)(b)(i).

Table 1 To Paragraph (1)(b)(i)

System Size (# People Served)	# Of Sites For Water Quality Parameters
>100,000	25
10,001 to 100,000	10
3,301 to 10,000	3
501 to 3,300	2
101 to 500	1
<=100	1

(ii)(A) Except as provided in paragraph (3)(b) of this section, water systems without corrosion control treatment must collect two (2) samples for each applicable water quality parameter at each entry point to the distribution system during each monitoring period specified in paragraph (2) of this section. During each monitoring period specified in paragraphs (3) through (5) of this section, water systems must collect one (1) sample for each applicable water quality parameter at each entry point to the distribution system.

(B) During each monitoring period specified in paragraphs (3) through (5) of the section, water systems with corrosion control treatment must continue to collect one (1) sample for each applicable water quality parameter at each entry point to the distribution system no less frequently than once every two (2) weeks.

(2) Initial Sampling for Water Systems-Any large water system without corrosion control treatment must monitor for water quality parameters as specified in paragraphs (2)(a) and (b) of this section during the first two (2) six (6)-month tap sampling monitoring periods beginning no later than January 1 of the calendar year after the system either becomes a large water system, or fails to maintain their 90th percentile for lead below the practical quantitation limit (PQL) for lead. Any medium or small system that exceeds the lead or copper action level and any system with corrosion control treatment for which the Department has not designated optimal water quality parameters (OWQPs) that exceeds the lead trigger level shall monitor for water quality parameters as specified in paragraphs (2)(a) and (b) of this section for two (2) consecutive six (6)-month periods beginning the month immediately following the end of the tap sampling period in which the exceedance occurred.

(a) At taps:

(i) pH;

(ii) Alkalinity; and

(b) At each entry point to the distribution system: all of the applicable parameters listed in paragraph (2)(a) of this section.

(3) Monitoring After Installation of Optimal Corrosion Control or Re-optimized Corrosion Control Treatment.

(a) Any system that installs or modifies corrosion control treatment pursuant to R.61-58.11.C(4)(e) or (5)(e) and is required to monitor pursuant R.61-58.11.C(4)(f) or (5)(f) must monitor the parameters identified in paragraphs (3)(a)(i) and (ii) of this section every six (6) months at the locations and frequencies specified in paragraphs (3)(a)(i) and (ii) of this section until the Department specifies new water quality parameter values for optimal corrosion control pursuant to paragraph (4) of this section. Water systems must collect these samples evenly throughout the six (6)-month monitoring period so as to reflect seasonal variability.

(i) At taps, two (2) samples each for:

(A) pH;

(B) Alkalinity;

(C) Orthophosphate, when an inhibitor containing an orthophosphate compound is used;

(D) Silica, when an inhibitor containing a silicate compound is used.

(ii) Except as provided in paragraph (3)(a)(iii) of this section, at each entry point to the distribution system, at least one sample no less frequently than every two weeks (biweekly) for:

(A) pH;

(B) When alkalinity is adjusted as part of optimal corrosion control, a reading of the dosage rate of the chemical used to adjust alkalinity, and the alkalinity concentration; and

(C) When a corrosion inhibitor is used as part of optimal corrosion control, a reading of the dosage rate of the inhibitor used, and the concentration of orthophosphate or silica (whichever is applicable).

(iii) Any groundwater system can limit entry point sampling described in paragraph (3)(a)(ii) of this section to those entry points that are representative of water quality and treatment conditions throughout the system. If water from untreated groundwater sources mixes with water from treated groundwater sources, the system must monitor for water quality parameters both at representative entry points receiving treatment and representative entry points receiving no treatment. Prior to the start of any monitoring under this paragraph (3)(a)(iii), the water system must provide to the Department written information identifying the selected entry points and documentation, including information on seasonal variability, sufficient to demonstrate that the sites are representative of water quality and treatment conditions throughout the system.

(b) The Department has the discretion to require small and medium-size systems with treatment for which the Department has not designated OWQPs that exceed the lead trigger level but not the

lead and copper action levels to conduct water quality parameter monitoring as described in paragraph (3)(a) of this section or the Department can develop its own water quality control parameter monitoring structure for these systems.

(4) Monitoring After the Department Specifies Water Quality Parameter Values for Optimal Corrosion Control

(a) After the Department specifies the values for applicable water quality parameters reflecting optimal corrosion control treatment under R.61–58.11.D(6), systems must monitor for the specified optimal water quality parameters during six (6)-month periods that begin on either January 1 or July 1. Such monitoring must be spaced evenly throughout the six (6)-month monitoring period so as to reflect seasonal variability and be consistent with the structure specified in paragraphs (3)(a)(i) through (iii) of this section.

(i) All large systems must measure the applicable water quality parameters specified by the Department and determine compliance with the requirements of R.61–58.11.D(7) every six (6) months with the first six (6)-month period to begin on either January 1 or July 1, whichever comes first, after the Department specifies the optimal values under R.61–58.11.D(6).

(ii) Any small or medium-size water system that exceeds an action level must begin monitoring during the six (6)-month period immediately following the tap sampling monitoring period in which the exceedance occurs and continue monitoring until the water system no longer exceeds the lead and copper action levels and meets the optimal water quality control parameters in two (2) consecutive six (6)-month tap sampling monitoring periods under R.61–58.11.H(4)(c). For any such small and medium-size system that is subject to a reduced monitoring frequency pursuant to R.61–58.11.H(4)(d) at the time of the action level exceedance, the start of the applicable six (6)-month monitoring period under this paragraph must coincide with the start of the applicable tap sampling monitoring period under R.61–58.11.H(4)(d).

(iii) Compliance with Department-designated optimal water quality parameter values must be determined as specified under R.61–58.11.D(7).

(b) Any small or medium-size system that exceeds the lead trigger level, but not the lead and copper action levels for which the Department has set optimal water quality control parameters must monitor as specified in paragraph (4)(a) of this section every six (6) months, until the system no longer exceeds the lead trigger level in two (2) consecutive tap sampling monitoring periods.

(c) The Department has the discretion to continue to require systems described in paragraph (4)(b) of this section to monitor optimal water quality control parameters.

(5) Reduced Monitoring

(a) Any large water system that maintains the range of values for the water quality parameters reflecting optimal corrosion control treatment specified by the Department under R.61–58.11.D(6) and does not exceed the lead trigger level during each of two (2) consecutive six (6)-month monitoring periods under paragraph (4) of this section must continue monitoring at the entry point(s) to the distribution system as specified in paragraph (3)(a)(ii) of this section. Such system may collect two (2) tap samples for applicable water quality parameters from the following reduced number of sites during each six (6) month monitoring period. Water systems must collect these samples evenly throughout the six (6)-month monitoring period so as to reflect seasonal variability.

**Reduced # Of Sites System SizeFor Water Quality Parameters
(# People Served)**

>100,000	10
10,001 to 100,000	7
3,301 to 10,000	3
501 to 3,300	2
101 to 500	1
≤100	1

(b)(i) Any water system that maintains the range of values for the water quality parameters reflecting optimal corrosion control treatment specified by the Department under R.61–58.11.D(6) and does not exceed the lead trigger level or copper action level during three (3) consecutive years of monitoring may reduce the frequency with which it collects the number of tap samples for

applicable water quality parameters specified in this paragraph (5)(a) of this section from every six (6) months to annually. This sampling begins during the calendar year immediately following the end of the monitoring period in which the third consecutive year of six (6)-month monitoring occurs.

(ii) A water system may reduce the frequency with which it collects tap samples for applicable water quality parameters specified in paragraph (5)(a) of this section to every year if it demonstrates during two (2) consecutive monitoring periods that its tap water lead level at the 90th percentile is less than or equal to the PQL for lead of 0.005 mg/L, that its tap water copper level at the 90th percentile is less than or equal to 0.65 mg/L in R.61–58.11.B(1)(b), and that it also has maintained the range of values for the water quality parameters reflecting optimal corrosion control treatment specified by the Department under R.61–58.11.D(6).

(c) A water system that conducts sampling annually must collect these samples evenly throughout the year so as to reflect seasonal variability.

(d) Any water system subject to reduced monitoring frequency that fails to operate at or above the minimum value or within the range of values for the water quality parameters specified by the Department under R.61–58.11.D(6), for more than nine (9) days in any six (6) month period specified in R.61–58.11.D(7), must resume distribution system tap water sampling in accordance with the number and frequency requirements in paragraph (4) of this section. Such a system may resume annual monitoring for water quality parameters at the tap at the reduced number of sites specified in paragraph (5)(a) of this section after it has completed two (2) subsequent consecutive six (6) month rounds of monitoring that meet the criteria of paragraph (5)(a) of this section and/or may resume annual monitoring for water quality parameters at the tap at the reduced number of sites after it demonstrates through subsequent rounds of monitoring that it meets the criteria of either paragraph (5)(b)(i) or (5)(b)(ii) of this section.

(6) Additional Monitoring by Systems

The results of any monitoring conducted in addition to the minimum requirements of this section must be considered by the water system and the Department in making any determinations (i.e., determining concentrations of water quality parameters) under this section or R.61–58.11.D.

(7) Additional Sites Added from Find-and-fix.

Any water system that conducts water quality parameter monitoring at additional sites through the “find-and-fix” provisions pursuant to R.61–58.11.D(10) must add those sites to the minimum number of sites specified under paragraphs (1) through (5) of this section unless the system is monitoring at least twice the minimum number of sites.

J. Monitoring Requirements for Lead and Copper in Source Water.

(1) Sample Location, Collection Methods, and Number of Samples

(a) A water system that fails to meet the lead or copper action level on the basis of tap samples collected in accordance with R.61–58.11.H above, shall collect lead and copper source water samples in accordance with the requirements regarding sample location, number of samples, and collection methods.

(i) Groundwater systems shall take a minimum of one (1) sample at every entry point to the distribution system after any application of treatment or in the distribution system at a point which is representative of each source after treatment (hereafter called a sampling point). The system shall take one (1) sample at the same sampling point unless conditions make another sampling point more representative of each source or treatment plant.

(ii) Surface water systems shall take a minimum of one sample at every entry point to the distribution system after any application of treatment or in the distribution system at a point which is representative of each source after treatment (hereafter called a sampling point). The system shall take each sample at the same sampling point unless conditions make another sampling point more representative of each source or treatment plant.

NOTE: For the purposes of this paragraph, surface water systems include systems with a combination of surface and ground sources.

(iii) if a system draws water from more than one source and the sources are combined before distribution, the system must sample at an entry point to the distribution system during periods of normal operating conditions (i.e., when water is representative of all sources being used).

(iv) The Department may reduce the total number of samples which must be analyzed by allowing the use of compositing. Compositing of samples must be done by certified laboratory personnel. Composite samples from a maximum of five (5) samples are allowed, provided that if the lead concentration in the composite sample is greater than or equal to 0.001 mg/L or the copper concentration is greater than or equal to 0.160 mg/L, then either:

(A) A follow-up sample shall be taken and analyzed within fourteen (14) days at each sampling point included in the composite; or

(B) If duplicates of or sufficient quantities from the original samples from each sampling point used in the composite are available, the system may use these instead of resampling.

(b) Where the results of sampling indicate an exceedance of maximum permissible source water levels established under R.61-58.11.E(2)(d) above, the Department may require that one additional sample be collected as soon as possible after the initial sample was taken (but not to exceed two weeks) at the same sampling point. If a Department- required confirmation sample is taken for lead or copper, then the results of the initial and confirmation sample shall be averaged in determining compliance with the Department- specified maximum permissible levels. Any sample value below the detection limit shall be considered to be zero. Any value above the detection limit but below the PQL shall either be considered as the measured value or be considered one-half the PQL.

(2) Monitoring Frequency After System Exceeds Tap Water Action Level

Any system which exceeds the lead or copper action level at the tap for the first time or for the first time after an addition of a new source or installation of source water treatment required under R.61-58.11.E(2)(b) shall collect one (1) source water sample from each entry point to the distribution system no later than six (6) months after the end of the tap sampling period during which the lead or copper action level was exceeded. For tap sampling periods that are annual or less frequent, the end of the tap sampling period is September 30 of the calendar year in which the sampling occurs, or if the Department has established an alternate monitoring period, the last day of that period. If the Department determines that source water treatment is not required under R.61-58.11.E(2)(b), the Department may waive source water monitoring, for any subsequent lead or copper action level exceedance at the tap, in accordance with the requirements in paragraphs (2)(a)(i) through (iii) of this section.

(a) The Department may waive source water monitoring for lead or copper action level exceedance at the tap under the following conditions:

(i) The water system has already conducted source water monitoring following a previous action level exceedance;

(ii) The Department has determined that source water treatment is not required; and

(iii) The system has not added any new water sources.

(b) [Reserved]

(3) Monitoring Frequency After Installation of Source Water Treatment and Addition of New Source

(a) Any system which installs source water treatment pursuant to R.61-58.11.E(1)(c) shall collect one (1) source water sample from each entry point to the distribution system during two (2) consecutive six (6)-month monitoring periods by the deadline specified in R.61-58.11.E(1)(d).

(b) Any system which adds a new source shall collect one (1) source water sample from each entry point to the distribution system until the system demonstrates that finished drinking water entering the distribution system has been maintained below the maximum permissible lead and copper concentrations specified by the Department in R.61-58.11.E(2)(d) or the Department determines that source water treatment is not needed.

(4) Monitoring Frequency after Department Specifies Maximum Permissible Source Water Levels

(a) A system shall monitor at the frequency specified in paragraphs (4)(a) and (b) of this section, in cases where the Department specifies maximum permissible source water levels under R.61-58.11.E(2)(d).

(i) A water system using only groundwater shall collect samples once during the three (3) year compliance period (as that term is defined in R.61-58.B, Definitions) in effect when the applicable Department determination under paragraph (4)(a) of this section is made. Such systems shall collect samples once during each subsequent compliance period. Triennial samples shall be collected every third calendar year.

(ii) A water system using surface water (or a combination of surface and groundwater) shall collect samples once during each calendar year, the first annual monitoring period to begin during the year in which the applicable Department determination is made under paragraph (4)(a) of this section.

(b) A system is not required to conduct source water sampling for lead and/or copper if the system meets the action level for the specific contaminant in tap water samples during the entire source water sampling period applicable to the system under paragraph (4)(a)(i) or (ii) of this section.

(5) Reduced Monitoring Frequency

(a) A water system using only ground water may reduce the monitoring frequency for lead and copper in source water to once during each nine (9)-year compliance cycle (as that term is defined in R.61-58.B, Definitions) provided that the samples are collected no later than every ninth calendar year and if the systems meets the following criteria:

(i) The system demonstrates that finished drinking water entering the distribution system has been maintained below the maximum permissible lead and copper concentrations specified by the Department in R.61-58.11.E(2)(d), during at least three (3) consecutive monitoring periods under paragraph (4)(a) of this section; or

(ii) The Department has determined that source water treatment is not needed and the system demonstrates that, during at least three consecutive compliance periods in which sampling was conducted under paragraph (4)(a) of this section, the concentration of lead in source water was less than or equal to 0.005 mg/L and the concentration of copper in source water was less than or equal to 0.65 mg/L.

(b) A water system using surface water (or a combination of surface and ground waters) may reduce the monitoring frequency in paragraph (4)(a) of this section to once during each nine (9)-year compliance cycle (as that term is defined in R.61-58.B, Definitions) provided that the samples are collected no later than every ninth calendar year and if the system meets the following criteria:

(i) The system demonstrates that finished drinking water entering the distribution system has been maintained below the maximum permissible lead and copper concentrations specified by the Department in Section E(2)(d) above, for at least three (3) consecutive years; or

(ii) The Department has determined that source water treatment is not needed and the system demonstrates that, during at least three (3) consecutive years, the concentration of lead in source water was less than or equal to 0.005 mg/L and the concentration of copper in source water was less than or equal to 0.65 mg/L.

(c) A water system that uses a new source of water is not eligible for reduced monitoring for lead and/or copper until concentrations in samples collected from the new source during three consecutive monitoring periods are below the maximum permissible lead and copper concentrations specified by the Department in R.61-58.11.E(1)(e).

K. Analytical Methods.

(1) Analyses for lead, copper, pH, alkalinity, orthophosphate, and silica, and temperature shall be conducted using EPA approved methods and other requirements listed in 40 CFR 141.23(k)(1).

(a) Analyses under R.61-58.11 shall only be conducted by laboratories that are certified by the Department.

(b) The Department has the authority to allow the use of previously collected monitoring data for purposes of monitoring, if the data were collected and analyzed in accordance with the requirements of this section.

(c) All lead and copper levels measured between the PQL and the MDL must be either reported as measured or they can be reported as one half the PQL specified for lead and copper in paragraph (1)(d) below. All levels below the lead and copper MDL must be reported as zero.

(d) The Practical Quantitation Level, or PQL for lead is 0.005 mg/L. The Practical Quantitation Level, or PQL for copper is 0.050 mg/L.

L. Reporting Requirements.

All water systems shall report all of the following information to the Department in accordance with this section.

(1) Reporting requirements for tap water monitoring for lead and copper and for water quality parameter monitoring.

(a) Notwithstanding the requirements of R.61-58.6.B(1), except as provided in paragraph (1)(a)(viii) of this section a water system must report the information specified in paragraphs (1)(a)(i) through (ix) of this section for all tap water samples specified in R.61-58.11.H and for all water quality parameter samples specified in R.61-58.11.I within the first ten (10) days following the end of each applicable tap sampling monitoring period specified in R.61-58.11.H and R.61-58.11.I (i.e., every six (6) months, annually, every three (3) years, or every nine (9) years). For tap sampling periods with a duration less than six (6) months, the end of the tap sampling monitoring period is the last date samples can be collected during that tap sampling period as specified in R.61-58.11.H and R.61-58.11.I.

(i) The results of all tap samples for lead and copper including the location of each site and the site selection criteria under R.61-58.11.H(1)(c) through (j), used as the basis for which the site was selected for the water system's sampling pool, accounting for R.61-58.11.H(1)(k);

(ii) Documentation for each tap water lead or copper sample for which the water system requests invalidation pursuant to R.61-58.11.H(5)(b) above;

(iii) Water systems with lead service lines, galvanized service lines requiring replacement, or lead status unknown service lines in the lead service line inventory conducted under R.61-58.11.F(1) must re-evaluate the tap sampling locations used in their sampling pool prior to the compliance date specified in R.61-58.11.B(1) and thereafter prior to the next round of tap sampling conducted by the system, or annually, whichever is more frequent.

(A) By the start of the first applicable tap sampling monitoring period in R.61-58.11.H(4), the water system must submit a site sample plan to the Department in accordance with R.61-58.11.H, including a list of tap sample site locations identified from the inventory in R.61-58.11.F(1), and a list of tap sampling water quality parameter (WQP) sites selected under R.61-58.11.I(1)(a). The site sample plan must be updated and submitted to the Department prior to any changes to sample site locations. The Department may require modifications to the site sample plan as necessary.

(B) For water systems with lead service lines with insufficient lead service line sites to meet the minimum number required in R.61-58.11.H, documentation in support of the conclusion that there are an insufficient number of lead service line sites meeting the criteria under R.61-58.11.H(1)(c) or (d) for community water systems or R.61-58.11.H(1)(h) for non-transient, non-community water systems, as applicable;

(iv) The 90th percentile lead and copper concentrations measured from among all lead and copper tap water samples collected during each tap sampling period (calculated in accordance with R.61-58.11.B(3)(d), unless the State calculates the water system's 90th percentile lead and copper levels under paragraph (8) of this section;

(v) With the exception of initial tap sampling conducted pursuant to R.61-58.11.H(4)(a)(i), the water system must identify any site which was not sampled during previous tap sampling periods, and include an explanation of why sampling sites have changed;

(vi) The results of all water quality parameter tap samples that are required to be collected under R.61-58.11.I(2) through (7);

(vii) The results of all samples collected at the entry point(s) to the distribution system for applicable water quality parameters under R.61-58.11.I(2) through(5);

(viii) A water system shall report the results of all water quality parameter samples collected under Section I(3) - (6) above, during each six (6)-month monitoring period specified in Section I(4) above, within the first ten (10) days following the end of the monitoring period unless the Department has specified a more frequent reporting requirement; and

(ix) By the start of the first applicable tap sampling period in R.61–58.11.H(4), the water system must submit to the Department a copy of the tap sampling protocol that is provided to individuals who are sampling. The Department shall verify that wide-mouth collection bottles are used and recommendations for pre-stagnation flushing and aerator cleaning or removal prior to sample collection are not included pursuant to R.61–58.11.H(2). The tap sampling protocol shall contain instructions for correctly collecting a first-draw sample for sites without lead service lines and a first-draw and a fifth liter sample for sites with lead service lines, where applicable. If the water system seeks to modify its tap sampling protocol specified in this paragraph (1)(a)(ix), it must submit the updated version of the protocol to the Department for review and approval no later than sixty (60) days prior to use.

(b) For a non-transient non-community water system, or a community water system meeting the criteria of R.61–58.11.H(2)(e), that does not have enough taps that can provide first-draw or fifth liter samples, the system must either:

(i) Provide written documentation to the Department identifying standing times and locations for enough non-first-draw and fifth liter samples to make up its sampling pool under R.61–58.11.H(2)(e), by the start of the first applicable monitoring period under R.61–58.11.H(4) unless the Department has waived prior Department approval of non-first-draw and fifth liter sample sites selected by the system pursuant to R.61–58.11.H(2)(e); or

(ii) If the Department has waived prior approval of non-first-draw sample sites selected by the system, identify, in writing, each site that did not meet the six-hour minimum standing time and the length of standing time for that particular substitute sample collected pursuant to R.61–58.11.H(2)(e) above, and include this information with the lead and copper tap sample results required to be submitted pursuant to paragraph (1)(a)(i) of this section.

(c) At a time specified by the Department, or if no specific time is designated by the Department, then as early as possible prior to the addition of a new source or any long-term change in water treatment, a water system must submit written documentation to the Department describing the change or addition. The Department must review and approve the addition of a new source or long-term change in treatment before it is implemented by the water system. The Department may require the system to take actions before or after the addition of a new source or long-term treatment change to ensure the system will operate and maintain optimal corrosion control treatment such as additional water quality parameter monitoring, additional lead or copper tap sampling, and re-evaluation of corrosion control treatment. Examples of long-term treatment changes include, but are not limited to, the addition of a new treatment process or modification of an existing treatment process. Examples of modifications include switching secondary disinfectants, switching coagulants (e.g., alum to ferric chloride), and switching corrosion inhibitor products (e.g., orthophosphate to blended phosphate). Long-term changes can also include dose changes to existing chemicals if the system is planning long-term changes to its finished water pH or residual inhibitor concentration. Long-term treatment changes would not include chemical dose fluctuations associated with daily raw water quality changes where a new source has not been added.

(d) Any small system applying for a monitoring waiver under R.61–58.11.H(7) above, or subject to a waiver granted pursuant to R.61–58.11.H(7)(c) above, shall provide the following information to the Department in writing by the specified deadline:

(i) By the start of the first applicable tap sampling monitoring period in R.61–58.11.H(4), any small water system applying for a monitoring waiver shall provide the documentation required to demonstrate that it meets the waiver criteria of R.61–58.11.H(7)(a) and (b).

(ii) No later than nine years after the monitoring previously conducted pursuant to R.61–58.11.H(7)(b) or R.61–58.11.H(7)(d)(i) above, each small system desiring to maintain its monitoring waiver shall provide the information required by R.61–58.11.H(7)(d)(i) and (ii) above.

(iii) No later than 60 days after it becomes aware that it is no longer free of lead-containing and/or copper-containing material, as appropriate, each small system with a monitoring waiver shall provide written notification to the Department, setting forth the circumstances resulting in the lead-containing and/or copper-containing materials being introduced into the system and what corrective action, if any, the system plans to remove these materials.

(e) Each ground water system that limits water quality parameter monitoring to a subset of entry points under R.61-58.11.I(3)(c) above, shall provide, by the commencement of such monitoring, written correspondence to the Department that identifies the selected entry points and includes information sufficient to demonstrate that the sites are representative of water quality and treatment conditions throughout the system.

(2) Source Water Monitoring Reporting Requirements

(a) A water system shall report the sampling results for all source water samples collected in accordance with R.61-58.11.J above within the first 10 days following the end of each source water monitoring period (i.e., annually, per compliance period, per compliance cycle) specified in R.61-58.11.J above.

(b) With the exception of the first round of source water sampling conducted pursuant to R.61-58.11.J(2) above, the system shall specify any site which was not sampled during previous monitoring periods, and include an explanation of why the sampling point has changed.

(3) Corrosion Control Treatment Reporting Requirements - By the applicable dates under R.61-58.11.C above, systems shall report the following information:

(a) For water systems demonstrating that they have already optimized corrosion control, information required in R.61-58.11.C(2)(a) through (c).

(b) For systems required to optimize corrosion control, their recommendation regarding optimal corrosion control treatment under R.61-58.11.D(1) above.

(c) For systems required to evaluate the effectiveness of corrosion control treatments under R.61-58.11.D(3) above, the information required by that paragraph.

(d) For systems required to install optimal corrosion control designated by the Department under R.61-58.11.D(4) above, a letter certifying that the system has completed installing that treatment.

(4) Source Water Treatment Reporting Requirements - By the applicable dates in R.61-58.11.E above, systems shall provide the following information to the Department:

(a) If required under R.61-58.11.E(2)(a) above, their recommendation regarding source water treatment;

(b) For systems required to install source water treatment under R.61-58.11.E(2)(b) above, a letter certifying that the system has completed installing the treatment designated by the Department within twenty four (24) months after the Department designated the treatment.

(5) Lead Service Line Inventory and Replacement Reporting Requirements Water systems must report the following information to the Department to demonstrate compliance with the requirements of R.61-58.11.F and R.61-58.11.G:

(a) No later than January 16, 2024, the water system must submit to the Department an inventory of service lines as required in R.61-58.11.F(1).

(b) No later than January 16, 2024, any water system that has inventoried a lead service line, galvanized requiring replacement, or lead status unknown service line in its distribution system must submit to the Department, as specified in Section R.61-58.11.F(2), a lead service line replacement plan.

(c) The water system must provide the Department with updated versions of its inventory as required in R.61-58.11.F(1) in accordance with its tap sampling monitoring period schedule as required in R.61-58.11.H(4), but no more frequently than annually. The updated inventory must be submitted within thirty (30) days of the end of each tap sampling monitoring period.

(i) When the water system has demonstrated that it has no lead, galvanized requiring replacement, or lead status unknown service lines in its inventory, it is no longer required to submit inventory updates to the Department, except as required in paragraph (5)(c)(ii) of this section.

(ii) In the case that a water system meeting the requirements of paragraph (5)(c)(i) of this section, subsequently discovers any service lines requiring replacement in its distribution system, it must notify the Department within thirty (30) days of identifying the service line(s) and prepare an updated inventory in accordance with R.61-58.11.F(1) on a schedule established by the Department.

(d) Within thirty (30) days of the end of each tap sampling monitoring period, the water system must certify that it conducted replacement of any encountered lead goosenecks, pigtails, and connectors in accordance with R.61-58.11.F(3).

(e) Within 30 days of the end of each tap sampling monitoring period, the water system must certify to the Department that any partial and full lead service line replacements were conducted in accordance with R.61-58.11.F(4) and (5), respectively.

(f) If the water system fails to meet the forty-five (45)-day deadline to complete a customer-initiated lead service line replacement pursuant to R.61-58.11.F(4)(d), it must notify the Department within thirty (30) days of the replacement deadline to request an extension of the deadline up to one hundred eighty (180) days of the customer-initiated lead service line replacement.

(i) The water system must certify annually that it has completed all customer-initiated lead service line replacements in accordance with R.61-58.11.F(4)(d).

(ii) [Reserved]

(g) No later than thirty (30) days after the end of the water system's annual lead service line replacement requirements under R.61-58.11.F(6) and (7), the water system must submit the following information to the Department, and continue to submit it each year it conducts lead service line replacement under R.61-58.11.F(6) and (7):

(i) The number of lead service lines in the initial inventory;

(ii) The number of galvanized requiring replacement service lines in the initial inventory;

(iii) The number of lead status unknown service lines in the inventory at the onset of the water system's annual lead service line replacement program;

(iv) The number of full lead service lines that have been replaced and the address associated with each replaced service line;

(v) The number of galvanized requiring replacement service lines that have been replaced and the address associated with each replaced service line;

(vi) The number of lead status unknown service lines remaining in the inventory;

(vii) The total number of lead status unknown service lines determined to be non-lead; and

(viii) The total number of service lines initially inventoried as "non-lead" later discovered to be a lead service line or a galvanized requiring replacement service line.

(h) No later than thirty (30) days after the end of each tap sampling period, any water system that has received customer refusals about lead service line replacements or customer nonresponses after a minimum of two (2) good faith efforts by the water system to contact customers regarding full lead service line replacements in accordance with R.61-58.11.F(7)(g), must certify to the Department the number of customer refusals or non-responses it received from customers served by a lead service line or galvanized requiring replacement service line, and maintain such documentation.

(i) No later than twelve (12) months after the end of a tap sampling period in which a water system exceeds the lead action level in sampling conducted pursuant to R.61-58.11.H, the system must provide to the Department its schedule for annually replacing an average annual rate, calculated on a two (2)-year rolling basis, of at least three percent (3%), or otherwise specified in R.61-58.11.F(7)(i), of the number of known lead service lines and galvanized lines requiring replacement when the lead trigger or action level was first exceeded and lead status unknown service lines at the beginning of each year that required replacement occurs in its distribution system.

(j) No later than twelve (12) months after the end of a sampling period in which a system exceeds the lead trigger level in sampling conducted pursuant to R.61-58.11.H, and every twelve (12) months thereafter, the system shall certify to the Department in writing that the system has:

(i) Conducted consumer notification as specified in R.61-58.11.F(6)(d) and R.61-58.11.G(7); and

(ii) Delivered public education materials to the affected consumers as specified in R.61-58.11.G(1).

(iii) A water system that does not meet its annual service line replacement goal as required under R.61-58.11.F(6) must certify to the Department in writing that the water system has

conducted public outreach as specified in R.61–58.11.G(8). The water system must also submit the outreach materials used to the Department.

(k) The annual submission to the Department under paragraph (5)(j) of this section must contain the following information:

(i) The certification that results of samples collected between three (3) months and six (6) months after the date of a full or partial lead service line replacement were provided to the resident in accordance with the timeframes in R.61–58.11.G(4)(b). Mailed notices postmarked within three (3) business days of receiving the results shall be considered “on time.”

(ii) [Reserved]

(l) Any system which collects samples following a partial lead service line replacement required by R.61–58.11.F must report the results to the Department within the first ten (10) days of the month following the month in which the system receives the laboratory results, or as specified by the Department. The Department, at its discretion, may eliminate this requirement to report these monitoring results, but water systems shall still retain such records. Systems must also report any additional information as specified by the Department, and in a time and manner prescribed by the Department, to verify that all partial lead service line replacement activities have taken place.

(m) Any system with lead service lines in its inventory must certify on an annual basis that the system has complied with the consumer notification of lead service line materials as specified in R.61–58.11.G(5).

(6) Public Education Program Reporting Requirements:

(a) Any water system that is subject to the public education requirements in R.61–58.11.G shall, within ten (10) days after the end of each period in which the system is required to perform public education in accordance with R.61–58.11.G(2) above, send written documentation to the Department that contains:

(i) The public education materials that were delivered, and a demonstration that the water system has delivered the public education materials that meet the content requirements in R.61–58.11.G(1) and the delivery requirements in R.61–58.11.G(2); and

(ii) A list of all the newspapers, radio stations, television stations, and facilities and organizations to which the system delivered public education materials during the period in which the system was required to perform public education tasks.

(b) Unless required by the Department, a system that previously has submitted the information required by paragraph (6)(a)(ii) of this section need not resubmit the information required by paragraph (6)(a)(ii) of this section, as long as there have been no changes in the distribution list and the system certifies that the public education materials were distributed to the same list submitted previously.

(c) No later than three (3) months following the end of the tap sampling period, each water system must mail a sample copy of the consumer notification of tap results to the Department along with a certification that the notification has been distributed in a manner consistent with the requirements of R.61–58.11G(4).

(d) Annually by July 1, the water system must demonstrate to the Department that it delivered annual consumer notification and delivered lead service line information materials to affected consumers with a lead, galvanized requiring replacement, or lead status unknown service line in accordance with R.61–58.11.G(5) for the previous calendar year. The water system shall also provide a copy of the notification and information materials to the Department.

(e) Annually by July 1, the water system must demonstrate to the Department that it conducted an outreach activity in accordance with R.61–58.11.G(8) when failing to meet the lead service line replacement goal as specified in R.61–58.11.F(6) for the previous calendar year. The water system shall also submit a copy to the Department of the outreach provided.

(f) Annually, by July 1, the water system must certify to the Department that it delivered notification to affected customers after any lead service line disturbance in accordance with R.61–58.11.G(6) for the previous calendar year. The water system shall also submit a copy of the notification to the Department.

(g) Annually, by July 1, the water system must certify to the Department that it delivered the required find-and-fix information to the Department and local health departments for the previous calendar year.

(7) Reporting of Additional Monitoring Data. Any water system which collects more samples than the minimum required, shall report the results to the Department within the first ten (10) days following the end of the applicable monitoring period under R.61-58.11.H, R.61-58.11.I, and R.61-58.11.J during which the samples are collected. This includes the monitoring data pertaining to “find-and-fix” pursuant to R.61-58.11.H(8) and R.61-58.11.I(7). The system must certify to the Department the number of customer refusals or nonresponses for follow-up sampling under R.61-58.11.D(10) it received and information pertaining to the accuracy of the refusals or nonresponses, within the first ten (10) days following the end of the applicable tap sampling period in which an individual sample exceeded the action level.

(8) Reporting of 90th Percentile Lead and Copper Concentrations Where the Department Calculates a Water System’s 90th Percentile Concentrations

A water system is not required to report the 90th percentile lead and copper concentrations measured from among all lead and copper tap water samples collected during each tap sampling monitoring period, as required by paragraph (1)(a)(iv) of this section if:

(a) The Department has previously notified the water system that it will calculate the water system’s 90th percentile lead and copper concentrations, based on the lead and copper tap results submitted pursuant to paragraph (8)(b)(i) of this section, and the water system provides the results of lead and copper tap water samples no later than ten (10) days after the end of the applicable tap sampling monitoring period;

(b) The system has provided the following information to the Department by the date specified in paragraph (8)(a) of this section:

(i) The results of all tap samples for lead and copper including the location of each site and the criteria under R.61-58.11.H(1)(c) through (j), under which the site was selected for the system’s sampling pool; and

(ii) An identification of sampling sites utilized during the current tap sampling monitoring period that were not sampled during previous monitoring periods, and an explanation of why sampling sites have changed; and

(c) The Department has provided the results of the 90th percentile lead and copper calculations, in writing, to the water system within fifteen (15) days of the end of the tap sampling period.

(9) Reporting Requirements for a Community Water System’s Public Education and Sampling in Schools and Child Care Facilities.

(a) A community water system shall send a report to the Department by July 1 of each year for the previous calendar year’s activity. The report must include the following:

(i) Certification that the water system made a good faith effort to identify schools and child care facilities in accordance with R.61-58.11.N(5). The good faith effort may include reviewing customer records and requesting lists of schools and child care facilities from the primacy agency or other licensing agency. A water system that certifies that no schools or child care facilities are served by the water system is not required to include information in paragraphs (9)(a)(ii) through (iv) of this section in the report. If there are changes to schools and child care facilities that a water system serves, an updated list must be submitted at least once every five (5) years in accordance with R.61-58.11.N(5).

(ii) Certification that the water system has delivered information about health risks from lead in drinking water to the school and child care facilities that they serve in accordance with R.61-58.11.N(1)(b) and (7)(a).

(iii) Certification that the water system has completed the notification and sampling requirements of R.61-58.11.N and paragraphs (9)(a)(iii)(A) through (E) of this section at a minimum of twenty percent (20%) of elementary schools and twenty percent (20%) of child care facilities. Certification that the water system has completed the notification and sampling requirements of R.61-58.11.N(7) and paragraphs (9)(a)(iii)(A), (B), and (E) of this section for any secondary school(s) sampled. After a water system has successfully completed one (1) cycle of required

sampling in all elementary schools and child care facilities identified in R.61–58.11.N(1)(a), it shall certify completion of the notification and sampling requirements of R.61–58.11.N(7) and paragraphs (9)(a)(iii)(A), (B), and (E) of this section for all sampling completed in any school or child care facility, thereafter.

(A) The number of schools and child care facilities served by the water system;

(B) The number of schools and child care facilities sampled in the calendar year;

(C) The number of schools and child care facilities that have refused sampling;

(D) Information pertaining to outreach attempts for sampling that were declined by the school or child care facility; and

(E) The analytical results for all schools and child care facilities sampled by the water system in the calendar year.

(iv) Certification that sampling results were provided to schools, child care facilities, and local and state health departments.

(b) [Reserved]

(10) Reporting Requirements for Small System Compliance Flexibility Options.

By the applicable dates provided in paragraphs (10)(a) and (b), water systems implementing requirements pursuant to R.61–58.11.O, shall provide the following information to the Department:

(a) Small water systems and non-transient, non-community water systems implementing the point-of-use (POU) device option under R.61–58.11.O(1)(c), shall report the results from the tap sampling required under R.61–58.11.O no later than ten (10) days after the end of the tap sampling monitoring period. If the trigger level is exceeded, the water system must reach out to the homeowner and/or building management within twenty-four (24) hours of receiving the tap sample results. The corrective action must be completed within thirty (30) days. If the corrective action is not completed within thirty (30) days, the system must provide documentation to the Department within thirty (30) days explaining why it was unable to correct the issue. Water systems selecting the POU device option under R.61–58.11.O(1)(c) shall provide documentation to certify maintenance of the POU devices unless the Department waives the requirement of this paragraph (10)(a).

(b) Small community water systems and non-transient, non-community water systems implementing the small system compliance flexibility option to replace all lead-bearing plumbing under R.61–58.11.O(1)(d) must provide certification to the Department that all lead-bearing material has been replaced on the schedule established by the Department, within one (1) year of designation of the option under R.61–58.11.O(1)(d).

M. Recordkeeping Requirements.

Any system subject to the requirements of this regulation shall retain on its premises original records of all sampling data and analyses, reports, surveys, letters, evaluations, schedules, Department determinations, and any other information required by R.61–58.11.C through R.61–58.11.J, R.61–58.11.L, R.61–58.11.N, and R.61–58.11.O. Each water system shall retain the records required by this section for no fewer than twelve (12) years.

N. Monitoring for Lead in Schools and Child Care Facilities.

All community water systems must conduct directed public education and lead monitoring at the schools and child care facilities they serve if those schools or child care facilities were constructed prior to January 1, 2014, or the date the state adopted standards that meet the definition of lead free in accordance with Section 1417 of the Safe Drinking Water Act, as amended by the Reduction of Lead in Drinking Water Act, whichever is earlier. Water systems must conduct lead sampling at elementary schools and child care facilities they serve once and on request of the facility thereafter. Water systems shall also conduct lead sampling at secondary schools they serve on request. The provisions of this section do not apply to a school or child care facility that is regulated as a public water system. The provisions in paragraph (1) of this section apply until a water system samples all the elementary schools and child care facilities they serve once as specified in paragraph (3) of this section. Thereafter, water systems shall follow the provisions as specified in paragraph (7) of this section.

(1) Public Education to Schools and Child Care Facilities

(a) By the compliance date specified in R.61-58.11.B(1)(c), each water system must compile a list of schools and child care facilities served by the system.

(b) Each water system must contact elementary schools and child care facilities identified by the system in paragraph (1)(a) of this section to provide:

(i) Information about health risks from lead in drinking water on at least an annual basis consistent with the requirements of R.61-58.11.G(1);

(ii) Notification that the water system is required to sample for lead at elementary schools and child care facilities, including:

(A) A proposed schedule for sampling at the facility;

(B) Information about sampling for lead in schools and child care facilities (EPA's 3Ts for Reducing Lead in Drinking Water Toolkit, EPA-815-B-18-007 or subsequent EPA guidance); and

(C) Instructions for identifying outlets for sampling and preparing for a sampling event thirty (30) days prior to the event.

(c) The water system must include documentation in accordance with R.61-58.11.L(9) if an elementary school or child care facility is non-responsive or otherwise declines to participate in the monitoring or education requirements of this section. For the purposes of this section, a school or child care facility is non-responsive after the water system makes at least two (2) separate good faith attempts to contact the facility to schedule sampling with no response.

(d) The water system must contact all secondary schools in paragraph (1)(a) of this section on at least an annual basis to provide information on health risks from lead in drinking water and how to request lead sampling as specified in paragraph (7)(a) of this section.

(2) Lead Sampling in Schools and Child Care Facilities

(a) Five (5) samples per school and two (2) samples per child care facility at outlets typically used for consumption shall be collected. Except as provided in paragraphs (2)(a)(i) through (vi) of this section, the outlets shall not have point-of-use (POU) devices. The water system shall sample at the following locations:

(i) For schools: two (2) drinking water fountains, one (1) kitchen faucet used for food or drink preparation, one (1) classroom faucet or other outlet used for drinking, and one (1) nurse's office faucet, as available.

(ii) For child care facilities: one (1) drinking water fountain and one (1) of either a kitchen faucet used for preparation of food or drink or one (1) classroom faucet or other outlet used for drinking.

(iii) If any facility has fewer than the required number of outlets, the water system must sample all outlets used for consumption.

(iv) The water system may sample at outlets with POU devices if the facility has POU devices installed on all outlets typically used for consumption.

(v) If any facility does not contain the type of faucet listed above, the water system shall collect a sample from another outlet typically used for consumption as identified by the facility.

(vi) Water systems must collect the samples from the cold water tap subject to the following additional requirements:

(A) Each sample for lead shall be a first-draw sample;

(B) The sample must be two hundred fifty milliliters (250 ml) in volume;

(C) The water must have remained stationary in the plumbing system of the sampling site (building) for at least eight (8) hours but no more than eighteen (18) hours; and

(D) Samples must be analyzed using acidification and the corresponding analytical methods in R.61-58.11.K.

(b) The water system, school or child care facility, or other appropriately trained individual may collect samples in accordance with paragraph (2)(a) of this section.

(3) Frequency of Sampling at Elementary Schools and Child Care Facilities

(a) Water systems shall collect samples from at least twenty percent (20%) of elementary schools served by the system and twenty percent (20%) of child care facilities served by the system per year, or according to a schedule approved by the Department, until all schools and child care facilities identified under paragraph (1)(a) of this section have been sampled or have declined to participate. For the purposes of this section, a water system may count a refusal or non-response from an elementary school or child care facility as part of the minimum twenty percent (20%) per year.

(b) All elementary schools and child care facilities must be sampled at least once in the five (5) years following the compliance date in R.61-58.11.B(1)(c).

(c) After a water system has completed one (1) required cycle of sampling in all elementary schools and child care facilities, a water system must sample at the request of an elementary school or child care facility in accordance with paragraph (7) of this section.

(d) A water system must sample at the request of a secondary school as specified in paragraph (7) of this section. If a water system receives requests from more than twenty percent (20%) of secondary schools identified in paragraph (1)(a) of this section in any of the five (5) years following the compliance date in R.61-58.11.B(1)(c), the water system may schedule the requests that exceed twenty percent (20%) for the following year and is not required to sample an individual secondary school more than once in the five (5)-year period.

(4) Alternative School and Child Care Lead Sampling Programs

(a) If mandatory sampling for lead in drinking water is conducted for schools and child care facilities served by a community water system due to state or local law or program, the Department may exempt the water system from the requirements of this section by issuing a written waiver:

(i) If the sampling is consistent with the requirements in paragraphs (2) and (3) of this section; or

(ii) If the sampling is consistent with the requirements in paragraphs (2)(a)(i) through (vi) and (3) of this section and it is coupled with any of the following remediation actions:

(A) Disconnection of affected fixtures;

(B) Replacement of affected fixtures with fixtures certified as lead free; and

(C) Installation of POU devices; or

(iii) If the sampling is conducted in schools and child care facilities served by the system less frequently than once every five (5) years and it is coupled with any of the remediation actions specified in paragraph (4)(a)(ii) of this section; or

(iv) If the sampling is conducted under a grant awarded under Section 1464(d) of the SDWA, consistent with the requirements of the grant.

(b) The duration of the waiver may not exceed the time period covered by the mandatory or voluntary sampling and will automatically expire at the end of any twelve (12)-month period during which sampling is not conducted at the required number of schools or child care facilities.

(c) The Department may issue a partial waiver to the water system if the sampling covers only a subset of the schools or child care facilities served by the system as designated under paragraph (1)(a) of this section.

(d) The Department may issue a written waiver applicable to more than one (1) system (e.g., one (1) waiver for all systems subject to a statewide sampling program that meets the requirements of paragraph (4) of this section).

(5) Confirmation or Revision of Schools and Child Care Facilities in Inventory

A water system shall either confirm that there have been no changes to its list of schools and child care facilities served by the system developed pursuant to paragraph (1)(a) of this section, or submit a revised list at least once every five (5) years.

(6) Notification of results

(a) A water system must provide analytical results as soon as practicable but no later than thirty (30) days after receipt of the results to the school or child care facility, along with information about remediation options.

(b) A water system must provide analytical results annually to:

- (i) The local and state health department; and
 - (ii) The Department in accordance with R.61-58.11.L(9).
- (7) Lead Sampling in Schools and Child Care Facilities on Request
- (a) A water system must contact schools and child care facilities identified in paragraph (1)(a) of this section on at least an annual basis to provide:
 - (i) Information about health risks from lead in drinking water;
 - (ii) Information about how to request sampling for lead at the facility; and
 - (iii) Information about sampling for lead in schools and child care facilities (EPA's 3Ts for Reducing Lead in Drinking Water Toolkit, EPA-815-B-18-007, or subsequent EPA guidance).
 - (b) A water system must conduct sampling as specified in paragraph (2) of this section when requested by the facility and provide:
 - (i) Instructions for identifying outlets for sampling and preparing for a sampling event at least thirty (30) days prior to the event; and
 - (ii) Results as specified in paragraph (6) of this section.
 - (c) If a water system receives requests from more than twenty percent (20%) of the schools and child care facilities identified in paragraph (1)(a) of this section in a given year, the water system may schedule sampling for those that exceed twenty percent (20%) for the following year. A water system is not required to sample an individual school or child care facility more than once every five (5) years.
 - (d) If voluntary sampling for lead in drinking water is conducted for schools and child care facilities served by a community water system that meets the requirements of this section, the Department may exempt the water system from the requirements of this section by issuing a written waiver in accordance with paragraph (4) of this section.

O. Small Water System Compliance Flexibility.

The compliance alternatives described in this section apply to small community water systems serving 10,000 or fewer persons and all non-transient, non-community water systems. Small community water systems and non-transient, non-community water systems with corrosion control treatment in place must continue to operate and maintain optimal corrosion control treatment (OCCT) until the Department determines, in writing, that it is no longer necessary, and meet any requirements that the Department determines to be appropriate before implementing a Department-approved compliance option described in this section.

(1) A small community water system and non-transient, non-community water systems that exceeds the lead trigger level but does not exceed the lead and copper action levels must collect water quality parameters in accordance with R.61-58.11.I(2) and evaluate compliance options in paragraphs (1)(a) through (d) of this section and make a compliance option recommendation to the Department within six (6) months of the end of the tap sampling period in which the exceedance occurred. The Department must approve the recommendation or designate an alternative from compliance options in paragraphs (1)(a) through (d) of this section within six (6) months of the recommendation by the water system. If the water system subsequently exceeds the lead action level it must implement the approved compliance option as specified in paragraph (2) of this section. Water systems must select from the following compliance options:

- (a) Lead service line replacement

A water system must implement a full lead service line replacement program on a schedule approved by the Department but not to exceed fifteen (15) years. A water system must begin lead service line replacement within one (1) year after the Department's approval or designation of the compliance option.

- (i) Lead service line replacement must be conducted in accordance with the requirements of R.61-58.11.F(5) and (7)(d), (h), and (i).
- (ii) A water system must continue lead service line replacement even if the system's 90th percentile lead level is at or below the action level in future tap sampling monitoring periods.

(iii) A water system must have no lead service lines, galvanized service lines requiring replacement, or “Lead status unknown” service lines in its inventory by the end of its lead service line replacement program.

(b) Corrosion control treatment

A water system must install and maintain optimal corrosion control treatment in accordance with R.61–58.11.C and R.61–58.11.D, even if its 90th percentile is at or below the action level in future tap sampling monitoring periods. Any water system that has corrosion control treatment installed must re-optimize its corrosion control treatment in accordance with R.61–58.11.C(4). Water systems required by the Department to optimize or re-optimize corrosion control treatment must follow the schedules in R.61–58.11.C(4) or (5), beginning with Step 3 in paragraph (4)(c) or (5)(c) of R.61–58.11.C unless the Department specifies optimal corrosion control treatment pursuant to either R.61–58.11.C(4)(b)(ii) or (5)(b)(i) or (ii), as applicable.

(c) Point-of-use devices

A water system must install, maintain, and monitor POU devices in each household or building even if its 90th percentile is at or below the action level in future tap sampling monitoring periods.

(i) Location Requirements

(A) A community water system must install a minimum of one (1) POU device (at one (1) tap) in every household and at every tap that is used for cooking and/or drinking in every non-residential building in its distribution system on a schedule specified by the Department, but not to exceed one (1) year.

(B) A non-transient, non-community water system must provide a POU device to every tap that is used for cooking and/or drinking on a schedule specified by the Department, but not to exceed three (3) months.

(ii) The POU device must be independently certified by a third party to meet the American National Standards Institute standard applicable to the specific type of POU unit to reduce lead in drinking water.

(iii) The POU device must be maintained by the water system according to manufacturer’s recommendations to ensure continued effective filtration, including, but not limited to, changing filter cartridges and resolving any operational issues. The POU device must be equipped with mechanical warnings to ensure that customers are automatically notified of operational problems. The water system shall provide documentation to the Department to certify maintenance of the POU devices, unless the Department waives this requirement, in accordance with R.61–58.11.L(10)(a).

(iv) The water system must monitor one-third of the POU devices each year and all POU devices must be monitored within a three (3)-year cycle. First-draw tap samples collected under this section must be taken after water passes through the POU device to assess its performance. Samples must be one-liter (1 L) in volume and have had a minimum six (6)-hour stagnation time. All samples must be at or below the lead trigger level. The water systems must report the results from the tap sampling no later than ten (10) days after the end of the tap sampling monitoring period in accordance with R.61–58.11.L(10)(a). The system must document the problem and take corrective action at any site where the sample result exceeds the lead trigger level. If the trigger level is exceeded, the water system must reach out to the homeowner and/or building management no later than twenty-four (24) hours of receiving the tap sample results. The corrective action must be completed within thirty (30) days. If the corrective action is not completed within thirty (30) days, the system must provide documentation to the Department within thirty (30) days explaining why it was unable to correct the issue.

(v) The water system must provide public education to consumers in accordance with R.61–58.11.G(10) to inform them on proper use of POU devices to maximize the units’ lead level reduction effectiveness.

(vi) The water system must operate and maintain the POU devices until the system receives Department approval to select one of the other compliance flexibility options and implements it.

(d) Replacement of lead-bearing plumbing

A water system that has control over all plumbing in its buildings, and no unknown, galvanized, or lead service lines, must replace all plumbing that is not lead free in accordance with Section 1417 of the Safe Drinking Water Act, as amended by the Reduction of Lead in Drinking Water Act and any future amendments applicable at the time of replacement. The replacement of all lead-bearing plumbing must occur on a schedule established by the Department but not to exceed one (1) year. Water systems must provide certification to the Department that all lead-bearing material has been replaced in accordance with R.61-58.11.L(10)(b).

(2)(a) A water system that exceeds the lead action level after exceeding the lead trigger level but does not exceed the copper action level must implement the compliance option approved by the Department under paragraph (1) of this section.

(b) A water system that exceeds the lead action level, but has not previously exceeded the lead trigger level, and does not exceed the copper action level must complete the provisions in paragraph (1) of this section and must implement the compliance option approved by the Department under paragraph (1) of this section.

(c) A water system that exceeds the trigger level after it has implemented a compliance option approved by the Department under paragraph (1) of this section, must complete the steps in paragraph (1) and if it thereafter exceeds the action level, it must implement the compliance option approved by the Department under paragraph (1) of this section.

HISTORY: Added by State Register Volume 17, Issue No. 12, eff December 24, 1993. Amended by State Register Volume 18, Issue No. 11, eff November 25, 1994; State Register Volume 19, Issue No. 7, eff July 28, 1995; State Register Volume 22, Issue No. 6, Part 2, eff June 26, 1998; State Register Volume No. 25, Issue No. 9, eff September 28, 2001; State Register Volume No. 26, Issue No. 12, eff December 27, 2002; State Register Volume 33, Issue No. 8, eff August 28, 2009; State Register Volume No. 38, Issue No. 9, Doc. No. 4469, eff September 26, 2014; SCSR 46-12 Doc. No. 5135, eff December 23, 2022.

61-58.12. Consumer Confidence Reports.

A. Applicability.

(1) This regulation establishes the minimum requirements for the content of annual reports that community water systems shall deliver to their customers. These reports shall contain information on the quality of the water delivered by the systems and characterize the risks (if any) from exposure to contaminants detected in the drinking water in an accurate and understandable manner. This regulation shall apply only to community water systems.

(2) For the purpose of this regulation, customers are defined as billing units or service connections to which water is delivered by a community water system.

(3) For the purpose of this regulation, detected means: at or above the levels prescribed in R.61-58.5, Maximum Contaminant Levels in Drinking Water.

B. Effective Dates.

(1) Each existing community water system shall deliver its first report by October 19, 1999, its second report by July 1, 2000, and subsequent reports by July 1 annually thereafter. The first report shall contain data collected during, or prior to, calendar year 1998 as prescribed in Section C. below. Each report thereafter shall contain data collected during, or prior to, the previous calendar year.

(2) A new community water system shall deliver its first report by July 1 of the year after its first full calendar year in operation and annually thereafter.

(3) A community water system that sells water to another community water system shall deliver the applicable information required in Section C below, to the buyer system:

(a) No later than April 19, 1999, by April 1, 2000, and by April 1 annually thereafter or

(b) On a date mutually agreed upon by the seller and the purchaser, and specifically included in a contract between the parties.

C. Content of the Reports.

(1) Each community water system shall provide to its customers an annual report that contains the information specified in this section and Section D below.

(2) Information on the source of the water delivered:

(a) Each report shall identify the source(s) of the water delivered by the community water system by providing information on:

- (i) The type of the water: e.g., surface water, ground water; and
- (ii) The commonly used name (if any) and location of the body (or bodies) of water.

(b) If a source water assessment has been completed, the report shall notify consumers of the availability of this information and the means to obtain it. In addition, systems are encouraged to highlight in the report significant sources of contamination in the source water area if they have readily available information. Where a system has received a source water assessment from the Department, the report shall include a brief summary of the system's susceptibility to potential sources of contamination, using language provided by the Department or written by the operator.

(3) Definitions.

(a) Each report shall include the following definitions:

(i) Maximum Contaminant Level Goal or MCLG: The level of a contaminant in drinking water below which there is no known or expected risk to health. MCLGs allow for a margin of safety.

(ii) Maximum Contaminant Level or MCL: The highest level of a contaminant that is allowed in drinking water. MCLs are set as close to the MCLGs as feasible using the best available treatment technology.

(b) A report for a community water system operating under a variance or an exemption issued under R. 61-58.9, Variances and Exemptions, shall include the following definition: Variances and Exemptions: the Department or EPA permission not to meet an MCL or a treatment technique under certain conditions.

(c) A report which contains data contaminants that the Department regulates using any of the following terms must include the applicable definitions:

(i) Treatment Technique: A required process intended to reduce the level of a contaminant in drinking water.

(ii) Action Level: The concentration of a contaminant which, if exceeded, triggers treatment or other requirements which a water system shall follow.

(iii) Maximum residual disinfectant level goal or MRDLG: The level of a drinking water disinfectant below which there is no known or expected risk to health. MRDLGs do not reflect the benefits of the use of the disinfectants to control microbial contaminants.

(iv) Maximum residual disinfectant level or MRDL: The highest level of a disinfectant allowed in drinking water. There is convincing evidence that addition of a disinfectant is necessary for control of microbial contaminants.

(d) A report that contains information regarding a Level 1 or Level 2 Assessment required under R.61-58.17 must include the applicable definitions:

(i) Level 1 Assessment: A Level 1 Assessment is a study of the water system to identify potential problems and determine (if possible) why total coliform bacteria have been found in our water system.

(ii) Level 2 Assessment: A Level 2 Assessment is a very detailed study of the water system to identify potential problems and determine (if possible) why an E. coli MCL violation has occurred and/or why total coliform bacteria have been found in our water system on multiple occasions.

(4) Information on Detected Contaminants.

(a) This sub-section specifies the requirements for information to be included in each report for contaminants subject to mandatory monitoring (except Cryptosporidium). It applies to:

(i) Contaminants subject to an MCL, action level, maximum residual disinfectant level or treatment technique (regulated contaminants);

(ii) Contaminants for which monitoring is required by R.61-58.5.T, Special Monitoring for Inorganic and Organic Contaminants (unregulated contaminants); and

(iii) Disinfection by-products or microbial contaminants for which monitoring is required by Secs. 141.142 and 141.143 (Information Collection Rule for disinfection by-products (DBP) and

Microbials (ICR)), of the National Primary Drinking Water Regulations (NPDWR), and which are detected in the finished water.

(b) The data relating to these contaminants shall be displayed in one table or in several adjacent tables. Any additional monitoring results which a community water system chooses to include in its report shall be displayed separately.

(c) The data shall be derived from data collected to comply with EPA and Department monitoring and analytical requirements during calendar year 1998 for the first report and subsequent calendar years thereafter except that:

(i) Where a system is allowed to monitor for regulated contaminants less often than once a year, the table(s) shall include the date and results of the most recent sampling and the report shall include a brief statement indicating that the data presented in the report are from the most recent testing done in accordance with the regulations. No data older than 5 years need be included.

(ii) Results of monitoring in compliance with the ICR (Secs. 141.142 and 141.143 of the NPDWR), need only be included for 5 years from the date of last sample or until any of the detected contaminants becomes regulated and subject to routine monitoring requirements, whichever comes first.

(d) For detected regulated contaminants (listed in Appendix D to this regulation), the table(s) shall contain:

(i) The MCL for that contaminant expressed as a number equal to or greater than 1.0 (as provided in Appendix D to this regulation);

(ii) The MCLG for that contaminant expressed in the same units as the MCL;

(iii) If there is no MCL for a detected contaminant, the table shall indicate that there is a treatment technique, or specify the action level, applicable to that contaminant, and the report shall include the definitions for treatment technique and/or action level, as appropriate, specified in paragraph(3)(c) of this section;

(iv) For contaminants subject to an MCL, except turbidity, total coliforms, fecal coliform and E.coli, the highest contaminant level used to determine compliance with R.61-58.5, Maximum Contaminant Levels in Drinking Water, and the range of detected levels, as follows:

(A) When compliance with the MCL is determined annually or less frequently: The highest detected level at any sampling point and the range of detected levels expressed in the same units as the MCL.

(B) When compliance with the MCL is determined by calculating a running annual average of all samples taken at a monitoring location: the highest average of any of the monitoring locations and the range of all monitoring locations expressed in the same units as the MCL. For the MCLs for TTHM and HAA5 in R.61 58.5.P(2)(b), systems must include the highest locational running annual average for TTHM and HAA5 and the range of individual sample results for all monitoring locations expressed in the same units as the MCL. If more than one location exceeds the TTHM or HAA5 MCL, the system must include the locational running annual averages for all locations that exceed the MCL.

(C) When compliance with the MCL is determined on a system wide basis by calculating a running annual average of all samples at all monitoring locations: the average and range of detection expressed in the same units as the MCL. The system is required to include individual sample results for the IDSE conducted under R.61 58.14 when determining the range of TTHM and HAA5 results to be reported in the annual consumer confidence report for the calendar year that the IDSE samples were taken.

Note to paragraph (4)(d)(iv): When rounding of results to determine compliance with the MCL is allowed by the regulations, rounding should be done prior to multiplying the results by the factor listed in Appendix D of this regulation;

(v) For turbidity.

(A) When it is reported pursuant to the requirements of R.61-58.10.C, Filtration and Disinfection [criteria for avoiding filtration]: the highest monthly value. The report should include an explanation of the reasons for measuring turbidity.

(B) When it is reported pursuant to R.61–58.10.E, Filtration and Disinfection [filtration], or R.61–58.10.H(4): The highest single measurement and the lowest monthly percentage of samples meeting the turbidity limits specified in R.61–58.10.E, Filtration, or R.61–58.10.H(4); for the filtration technology being used. The report should include an explanation of the reasons for measuring turbidity;

(C) When it is reported pursuant to R.61–58.10.E or R.61–58.10.H(4) or R.61–58.10.I(6): the highest single measurement and the lowest monthly percentage of samples meeting the turbidity limits specified in R.61–58.10.E or R.61–58.10.H(4) or R.61–58.10.I(6) for the filtration technology being used. The report should include an explanation of the reasons for measuring turbidity.

(vi) For lead and copper: the 90th percentile concentration of the most recent round(s) of sampling, the number of sampling sites exceeding the action level, and the range of tap sampling results;

(vii) For total coliform analytical results until March 31, 2016:

(A) The highest monthly number of positive samples for systems collecting fewer than forty (40) samples per month; or

(B) The highest monthly percentage of positive samples for systems collecting at least forty (40) samples per month.

(viii) For fecal coliform and E.coli. until March 31, 2016: The total number of positive samples;

(ix) The likely source(s) of detected contaminants to the best of the operator's knowledge. Specific information regarding contaminants may be available in sanitary surveys and source water assessments, and should be used when available to the operator. If the operator lacks specific information on the likely source, the report shall include one or more of the typical sources for that contaminant listed in Appendix D to this regulation which are most applicable to the system;

(x) For E.coli analytical results under R.61–58.17: The total number of positive samples;

(xi) The report shall include a statement that a service line inventory (including inventories consisting only of a statement that there are no lead service lines) has been prepared and include instructions to access the service line inventory; and

(xii) The report shall notify consumers that complete lead tap sampling data are available for review and shall include information on how to access the data.

(5) If a community water system distributes water to its customers from multiple hydraulically independent distribution systems that are fed by different raw water sources, the table should contain a separate column for each service area and the report should identify each separate distribution system. Alternatively, systems could produce separate reports tailored to include data for each service area.

(6) The table(s) shall clearly identify any data indicating violations of MCLs or treatment techniques and the report shall contain a clear and readily understandable explanation of the violation including: the length of the violation, the potential adverse health effects, and actions taken by the system to address the violation. To describe the potential health effects, the system shall use the relevant language of Appendix D to this regulation.

(7) For detected unregulated contaminants for which monitoring is required (except *Cryptosporidium*), the table(s) shall contain the average and range at which the contaminant was detected. The report may include a brief explanation of the reasons for monitoring for unregulated contaminants.

(8) Information on *Cryptosporidium*, radon, and other contaminants:

(a) If the system has performed any monitoring for *Cryptosporidium*, including monitoring performed to satisfy the requirements of Sec. 141.143 (NPDWR Microbial Monitoring), which indicates that *Cryptosporidium* may be present in the source water or the finished water, the report shall include:

(i) A summary of the results of the monitoring; and

(ii) An explanation of the significance of the results.

(b) If the system has performed any monitoring for radon which indicates that radon may be present in the finished water, the report shall include:

- (i) The results of the monitoring; and
- (ii) An explanation of the significance of the results.

(c) If the system has performed additional monitoring which indicates the presence of other contaminants in the finished water, the Department strongly encourages systems to report any results which may indicate a health concern. To determine if results may indicate a health concern, the Department recommends that systems find out if EPA has proposed an NPDWR or issued a health advisory for that contaminant by calling the Safe Drinking Water Hotline (800-426-4791). EPA and the Department considers detects above a proposed MCL or health advisory level to indicate possible health concerns. For such contaminants, EPA and the Department recommends that the report include:

- (i) The results of the monitoring; and
- (ii) An explanation of the significance of the results noting the existence of a health advisory or a proposed regulation.

(9) Compliance with the State Primary Drinking Water Regulations (SPDWR). In addition to the requirements of this regulation, the report shall note any violation that occurred during the year covered by the report of a requirement listed below, and include a clear and readily understandable explanation of the violation, any potential adverse health effects, and the steps the system has taken to correct the violation:

(a) Monitoring and reporting of compliance data;

(b) Filtration and disinfection prescribed by R.61-58.10, Filtration and Disinfection. For systems which have failed to install adequate filtration or disinfection equipment or processes, or have had a failure of such equipment or process which constitutes a violation, the report shall include the following language as part of the explanation of potential adverse health effects: "Inadequately treated water may contain disease-causing organisms. These organisms include bacteria, viruses, and parasites which can cause symptoms such as nausea, cramps, diarrhea, and associated headaches;"

(c) Lead and copper control requirements prescribed by R.61-58.11, Lead and Copper. For systems which fail to take one or more actions prescribed by R.61-58.11.B(2) [Corrosion Control Treatment Requirements], R.61-58.11.C [Applicability of Corrosion Control Treatment Steps to Small, Medium-Size and Large Water Systems], R.61-58.11(D) [Description of Corrosion Control Treatment Requirements], R.61-58.11.E [Source Water Treatment Requirements], R.61-58.11.F [Lead Service Line Replacement Requirements], the report shall include the applicable language of Appendix D to this regulation for lead, copper, or both;

(d) Treatment techniques for Acrylamide and Epichlorohydrin prescribed by R.61-58.5.AA, Treatment Techniques. For systems which violate the requirements of R.61-58.5.AA, the report shall include the relevant language from Appendix D to this regulation;

(e) Recordkeeping of compliance data;

(f) Special monitoring requirements prescribed by R.61-58.5.T, Special Monitoring for Inorganic and Organic Contaminants, and R.61-58.5.U, Special Monitoring for Sodium; and

(g) Violation of the terms of a variance, an exemption, or an administrative or judicial order.

(10) Variances and Exemptions. If a system is operating under the terms of a variance or an exemption issued under R.61-58.9, Variances and Exemptions, the report shall contain:

(a) An explanation of the reasons for the variance or exemption;

(b) The date on which the variance or exemption was issued;

(c) A brief status report on the steps the system is taking to install treatment, find alternative sources of water, or otherwise comply with the terms and schedules of the variance or exemption; and

(d) A notice of any opportunity for public input in the review, or renewal, of the variance or exemption.

(11) Additional information:

(a) The report shall contain a brief explanation regarding contaminants which may reasonably be expected to be found in drinking water including bottled water. This explanation may include the

language of paragraphs (i) through (iii) below or systems may use their own comparable language. The report also shall include the language of paragraph (iv) below:

(i) "The sources of drinking water (both tap water and bottled water) include rivers, lakes, streams, ponds, reservoirs, springs, and wells. As water travels over the surface of the land or through the ground, it dissolves naturally-occurring minerals and, in some cases, radioactive material, and can pick up substances resulting from the presence of animals or from human activity."

(ii) "Contaminants that may be present in source water include:

(A) Microbial contaminants, such as viruses and bacteria, which may come from sewage treatment plants, septic systems, agricultural livestock operations, and wildlife.

(B) Inorganic contaminants, such as salts and metals, which can be naturally-occurring or result from urban stormwater runoff, industrial or domestic wastewater discharges, oil and gas production, mining, or farming.

(C) Pesticides and herbicides, which may come from a variety of sources such as agriculture, urban stormwater runoff, and residential uses.

(D) Organic chemical contaminants, including synthetic and volatile organic chemicals, which are by-products of industrial processes and petroleum production, and can also come from gas stations, urban stormwater runoff, and septic systems.

(E) Radioactive contaminants, which can be naturally-occurring or be the result of oil and gas production and mining activities.:

(iii) "In order to ensure that tap water is safe to drink, EPA and the Department prescribe regulations which limit the amount of certain contaminants in water provided by public water systems. FDA regulations establish limits for contaminants in bottled water which shall provide the same protection for public health."

(iv) "Drinking water, including bottled water, may reasonably be expected to contain at least small amounts of some contaminants. The presence of contaminants does not necessarily indicate that water poses a health risk. More information about contaminants and potential health effects can be obtained by calling the Environmental Protection Agency's Safe Drinking Water Hotline (800-426-4791)."

(b) The report shall include the telephone number of the owner, operator, or designee of the community water system as a source of additional information concerning the report.

(c) In communities with a large proportion of non-English speaking residents, as determined by the Department, the report shall contain information in the appropriate language(s) regarding the importance of the report or contain a telephone number or address where such residents may contact the system to obtain a translated copy of the report or assistance in the appropriate language.

(d) The report shall include information (e.g., time and place of regularly scheduled board meetings) about opportunities for public participation in decisions that may affect the quality of the water.

(e) The systems may include such additional information as they deem necessary for public education consistent with, and not detracting from, the purpose of the report.

(f) Systems required to comply with R.61-58.16.

(i) Any ground water system that receives notice from the Department of a significant deficiency or notice from a laboratory of a fecal indicator positive ground water source sample that is invalidated by the Department must inform its customers of any significant deficiency that is uncorrected at the time of the next report or of any fecal indicator positive ground water source sample in the next report. The system must continue to inform the public annually until the Department determines that particular significant deficiency is corrected or the fecal contamination in the ground water source is addressed under R.61-58.16.F(1). Each report must include the following elements.

(A) The nature of the particular significant deficiency or the source of the fecal contamination (if the source is known) and the date the significant deficiency was identified by the Department or the dates of the fecal indicator-positive ground water source samples.

(B) If the fecal contamination in the ground water source has been addressed under R.61-58.16.F(1) and the date of such action.

(C) For each significant deficiency or fecal contamination in the ground water source that has not been addressed under R.61-58.16.F(1), the Department approved plan and schedule for correction, including interim measures, progress to date, and any interim measures completed; and

(D) If the system receives notice of a fecal indicator positive ground water source sample that is not invalidated by the Department, the potential health effects using the health effects language of Appendix D of R.61-58.12.

(ii) If directed by the Department, a system with significant deficiencies that have been corrected before the next report is issued must inform its customers of the significant deficiency, how the deficiency was corrected, and the date of correction.

(g) Systems required to comply with R.61-58.17:

(i) Any system required to comply with the Level 1 assessment requirement or a Level 2 assessment requirement that is not due to an E. coli MCL violation must include in the report the text found in paragraph R.61-58.12.C(11)(g)(i)(A) and paragraphs R.61-58.12.C(11)(g)(i)(B) and R.61-58.12.C(11)(g)(i)(C) as appropriate, filling in the blanks accordingly and the text found in paragraphs R.61-58.12.C(11)(g)(i)(D)(1) and R.61-58.12.C(11)(g)(i)(D)(2) if appropriate.

(A) Coliforms are bacteria that are naturally present in the environment and are used as an indicator that other, potentially harmful, waterborne pathogens may be present or that a potential pathway exists through which contamination may enter the drinking water distribution system. We found coliforms indicating the need to look for potential problems in water treatment or distribution. When this occurs, we are required to conduct assessment(s) to identify problems and to correct any problems that were found during these assessments.

(B) During the past year we were required to conduct [INSERT NUMBER OF LEVEL 1 ASSESSMENTS] Level 1 assessment(s). [INSERT NUMBER OF LEVEL 1 ASSESSMENTS] Level 1 assessment(s) were completed. In addition, we were required to take [INSERT NUMBER OF CORRECTIVE ACTIONS] corrective actions and we completed [INSERT NUMBER OF CORRECTIVE ACTIONS] of these actions.

(C) During the past year [INSERT NUMBER OF LEVEL 2 ASSESSMENTS] Level 2 assessments were required to be completed for our water system. [INSERT NUMBER OF LEVEL 2 ASSESSMENTS] Level 2 assessments were completed. In addition, we were required to take [INSERT NUMBER OF CORRECTIVE ACTIONS] corrective actions and we completed [INSERT NUMBER OF CORRECTIVE ACTIONS] of these actions.

(D) Any system that has failed to complete all the required assessments or correct all identified sanitary defects, is in violation of the treatment technique requirement and must also include one or both of the following statements, as appropriate:

(1) During the past year we failed to conduct all of the required assessment(s).

(2) During the past year we failed to correct all identified defects that were found during the assessment.

(ii) Any system required to conduct a Level 2 assessment due to an E. coli MCL violation must include in the report the text found in paragraphs R.61-58.12.C(11)(g)(ii)(A) and R.61-58.12.C(11)(g)(ii)(B), filling in the blanks accordingly and the text found in paragraphs R.61-58.12.C(11)(g)(ii)(C)(1) and R.61-58.12.C(11)(g)(ii)(C)(2), if appropriate.

(A) E. coli are bacteria whose presence indicates that the water may be contaminated with human or animal wastes. Human pathogens in these wastes can cause short-term effects, such as diarrhea, cramps, nausea, headaches, or other symptoms. They may pose a greater health risk for infants, young children, the elderly, and people with severely compromised immune systems. We found E. coli bacteria, indicating the need to look for potential problems in water treatment or distribution. When this occurs, we are required to conduct assessment(s) to identify problems and to correct any problems that were found during these assessments.

(B) We were required to complete a Level 2 assessment because we found E. coli in our water system. In addition, we were required to take [INSERT NUMBER OF CORRECTIVE

ACTIONS] corrective actions and we completed [INSERT NUMBER OF CORRECTIVE ACTIONS] of these actions.

(C) Any system that has failed to complete the required assessment or correct all identified sanitary defects is in violation of the treatment technique requirement and must also include one or both of the following statements, as appropriate:

(1) We failed to conduct the required assessment.

(2) We failed to correct all sanitary defects that were identified during the assessment that we conducted.

(iii) If a system detects *E. coli* and has violated the *E. coli* MCL, in addition to completing the table as required in R.61-58.12.C(4)(d), the system must include one or more of the following statements to describe any noncompliance, as applicable:

(A) We had an *E. coli*-positive repeat sample following a total coliform-positive routine sample.

(B) We had a total coliform-positive repeat sample following an *E. coli*-positive routine sample.

(C) We failed to take all required repeat samples following an *E. coli*-positive routine sample.

(D) We failed to test for *E. coli* when any repeat sample tests positive for total coliform.

(iv) If a system detects *E. coli* and has not violated the *E. coli* MCL, in addition to completing the table as required in paragraph R.61-58.12.C(4)(d), the system may include a statement that explains that although they have detected *E. coli*, they are not in violation of the *E. coli* MCL.

D. Required Additional Health Information.

(1) All reports shall prominently display the following language: "Some people may be more vulnerable to contaminants in drinking water than the general population. Immuno-compromised persons such as persons with cancer undergoing chemotherapy, persons who have undergone organ transplants, people with HIV/AIDS or other immune system disorders, some elderly, and infants can be particularly at risk from infections. These people should seek advice about drinking water from their health care providers. EPA/CDC guidelines on appropriate means to lessen the risk of infection by *Cryptosporidium* and other microbial contaminants are available from the Safe Drinking Water Hotline (800-426-4791)."

(2) Ending in the report due by July 1, 2001, a system which detects arsenic at levels above 0.025 mg/L, but below the 0.05 mg/L, and beginning in the report due by July 1, 2002, a system that detects arsenic above 0.005 mg/L and up to and including 0.01 mg/L:

(a) Shall include in its report a short informational statement about arsenic, using language such as: While your drinking water meets State and Federal standards for arsenic, it does contain low levels of arsenic. The Federal standard balances the current understanding of arsenic's possible health effects against the cost of removing arsenic from drinking water. EPA continues to research health effects of low levels of arsenic, which is a mineral known to cause cancer in humans at high concentrations and is linked to other health effects such as skin damage and circulatory problems.

(b) May write its own educational statement, but only in consultation with the Department.

(3) A system which detects nitrate at levels above 5 mg/l, but below the MCL:

(a) Shall include a short informational statement about the impacts of nitrate on children using language such as: "Nitrate in drinking water at levels above 10 ppm is a health risk for infants of less than six months of age. High nitrate levels in drinking water can cause blue baby syndrome. Nitrate levels may rise quickly for short periods of time because of rainfall or agricultural activity. If you are caring for an infant you should ask advice from your health care provider."

(b) May write its own educational statement, but only in consultation with the Department.

(4) Every report must include the following lead-specific information:

(a) A short informational statement about lead in drinking water and its effects on children. The statement must include the following information: Lead can cause serious health problems, especially for pregnant women and young children. Lead in drinking water is primarily from materials and components associated with service lines and home plumbing. [NAME OF UTILITY] is responsible for providing high quality drinking water and removing lead pipes, but cannot control the variety of

materials used in plumbing components in your home. You share the responsibility for protecting yourself and your family from the lead in your home plumbing. You can take responsibility by identifying and removing lead materials within your home plumbing and taking steps to reduce your family's risk. Before drinking tap water, flush your pipes for several minutes by running your tap, taking a shower, doing laundry, or a load of dishes. You can also use a filter certified by an American National Standards Institute accredited certifier to reduce lead in drinking water. If you are concerned about lead in your water and wish to have your water tested, contact [NAME OF UTILITY and CONTACT INFORMATION]. Information on lead in drinking water, testing methods, and steps you can take to minimize exposure is available at <http://www.epa.gov/safewater/lead>.

(b) A system may write its own educational statement, but only in consultation with the Department.

(5) Community water systems that detect TTHM above 0.080 mg/l, but below the MCL in R.61-58.5.L, as an annual average, monitored and calculated under the provisions of R.61-58.5.M, must include health effects language prescribed by Appendix D to of this regulation.

(6) Beginning in the report due by July 1, 2002 and ending January 22, 2006, a community water system that detects arsenic above 0.01 mg/L and up to and including 0.05 mg/L must include the arsenic health effect language prescribed by Appendix D to this regulation.

E. Report Delivery and Recordkeeping.

(1) Except as provided in paragraph (7) below, each community water system shall mail or otherwise directly deliver one copy of the report to each customer.

(2) The system shall make a good faith effort to reach consumers who do not get water bills, using means recommended by the Department. The Department expects that an adequate good faith effort will be tailored to the consumers who are served by the system but are not bill-paying customers, such as renters or workers. A good faith effort to reach consumers would include a mix of methods appropriate to the particular system such as: Posting the reports on the Internet; mailing to postal patrons in metropolitan areas; advertising the availability of the report in the news media; publication in a local newspaper; posting in public places such as cafeterias or lunch rooms of public buildings; delivery of multiple copies for distribution by single-biller customers such as apartment buildings or large private employers; delivery to community organizations.

(3) No later than the date the system is required to distribute the report to its customers, each community water system shall mail a copy of the report to the Department, followed within 3 months by a certification that the report has been distributed to customers, and that the information is correct and consistent with the compliance monitoring data either provided by or submitted to the Department.

(4) No later than the date the system is required to distribute the report to its customers, each community water system shall deliver the report to any other agency or clearinghouse identified by the Department.

(5) Each community water system shall make its reports available to the public upon request.

(6) Each community water system serving 100,000 or more persons shall post its current year's report to a publicly-accessible site on the Internet.

(7) The Department can waive the requirement of paragraph (1) of this section for community water systems serving fewer than 10,000 persons.

(a) Such systems shall:

(i) Publish the reports in one or more local newspapers serving the area in which the system is located;

(ii) Inform the customers that the reports will not be mailed, either in the newspapers in which the reports are published or by other means approved by the Department; and

(iii) Make the reports available to the public upon request.

(b) Systems serving 500 or fewer persons may forego the requirements of paragraphs (7)(a)(i) above, if they provide notice at least once per year to their customers by mail, door-to-door delivery or by posting in an appropriate location that the report is available upon request.

(8) Any system subject to this regulation shall retain copies of its Consumer Confidence Report for no less than three (3) years.

HISTORY: Added by State Register Volume 23, Issue No. 2, eff February 26, 1999. Amended by State Register Volume 24, Issue No. 2, eff February 25, 2000; State Register Volume 25, Issue No. 9, eff September 28, 2001; State Register Volume 26, Issue No. 12, eff December 27, 2002; State Register Volume 30, Issue No. 10, eff October 27, 2006; State Register Volume 32, Issue No. 4, eff April 25, 2008; State Register Volume 33, Issue No. 8, eff August 28, 2009; State Register Volume 38, Issue No. 9, Doc. No. 4469, eff September 26, 2014; SCSR 46–12 Doc. No. 5135, eff December 23, 2022.

APPENDIXD. CONSUMER CONFIDENCE REPORTS: REGULATED CONTAMINANTS

Contaminant (units)	Traditional MCL in mg/L	To convert for CCR, multiply by	MCL in CCR units	MCLG	Major sources in drinking water	Health effects language
Microbiological contaminants:						
Total Coliform Bacteria †	MCL: (systems that collect ≥ 40 samples/month) 5% of monthly samples are positive; (systems that collect <40 samples/month) 1 positive monthly sample.		MCL: (systems that collect ≥40 samples/month) 5% of monthly samples are positive; (systems that collect <40 samples/month) 1 positive monthly sample.	0	Naturally present in the environment	Coliforms are bacteria that are naturally present in the and are used as an indicator that other, potentially harmful bacteria may be present. Coliforms were found in more samples than allowed and this was a warning of potential problems.
Total Coliform Bacteria ‡	TT			N/A	Naturally present in the environment	Use language in R.51–58.12. C(11)(g)(i)(A)
Fecal coliform and E. coli †	0		0	0	Human and animal fecal waste	Fecal coliforms and E. Coli are bacteria whose presence indicates that the water may be contaminated with human or animal wastes. Microbes in these wastes can cause short-term effects, such as diarrhea, cramps, nausea, headaches, or other symptoms. They may pose a special health risk for infants, young children, some of the elderly, and people with severely-compromised immune systems.
E. coli ‡	Routine and repeat samples are total coliform-positive and either is E. coli-positive or system fails to take repeat samples following E. coli-positive routine sample or system fails to analyze total coliform-positive repeat sample for E. coli		Routine and repeat samples are total coliform-positive and either is E. coli-positive or system fails to take repeat samples following E. coli-positive routine sample or system fails to analyze total coliform-positive repeat sample for E. coli	0	Human and animal fecal waste	E. coli are bacteria whose presence indicates that the water may be contaminated with human or animal wastes. Human pathogens in these wastes can cause short-term effects, such as diarrhea, cramps, nausea, headaches, or other symptoms. They may pose a greater health risk for infants, young children, the elderly, and people with severely-compro-

Contaminant (units)	Traditional MCL in mg/L	To convert for CCR, multiply by	MCL in CCR units	MCLG	Major sources in drinking water	Health effects language
Fecal Indicators (enterococci or coliphage).	TT		TT	N/A	Human animal waste. and fecal	mised immune systems. Fecal indicators are microbes whose presence indicates that the water may be contaminated with human or animal wastes. Microbes in these wastes can cause short-term health effects, such as diarrhea, cramps, nausea, headaches, or other symptoms. They may pose a special health risk for infants, young children, some of the elderly, and people with severely compromised immune systems.
Total organic carbon (ppm)	TT		TT	N/A	Naturally present	Total organic carbon (TOC) has no health effects. However, total organic carbon in the environment provides a medium for the formation of disinfection by-products. These byproducts include trihalomethanes (THMs) and haloacetic acids (HAAs). Drinking water containing these by-products in excess of the MCL may lead to adverse health effects, liver or kidney problems, or nervous system effects, and may lead to an increased risk of getting cancer.
Turbidity (NTU)	TT		TT	N/A	Soil runoff	Turbidity has no health effects. However, turbidity can interfere with disinfection and provide a medium for microbial growth. Turbidity may indicate the presence of disease-causing organisms. These organisms include bacteria, viruses, and parasites that can cause symptoms such as nausea, cramps, diarrhea and associated headaches.
Radioactive contaminants:						
Beta/photon emitters (mrem/yr)	4 mrem/yr		4	N/A	Decay of natural and man-made deposits.	Certain minerals are radioactive and may emit forms of radiation known as photons and beta radiation. Some

Contaminant (units)	Traditional MCL in mg/L	To convert for CCR, multiply by	MCL in CCR units	MCLG	Major sources in drinking water	Health effects language
Alpha emitters (pCi/L)	15 pCi/L		15	N/A	Erosion of natural deposits.	people who drink water containing beta and photon in excess of the MCL over many years may have an increased risk of getting cancer. Certain minerals are radioactive and may emit a form of radiation known as alpha radiation. Some people who drink water containing alpha emitters in excess of the MCL over many years may have an increased risk of getting cancer.
Combined radium (pCi/L)	5 pCi/L		5	N/A	Erosion of natural deposits.	Some people who drink water containing radium-226 or 228 in excess of the MCL over many years may have an increased risk of getting cancer.
Uranium (pCi/L)	30 µg/L		30	0	Erosion of natural deposits.	Some people who drink water containing uranium in excess of the MCL over many years may have an increased risk getting cancer and kidney toxicity.
Inorganic contaminants:						
Antimony (ppb)	.006	1000	6	6	Discharge from petroleum refineries; fire retardants; ceramics; electronics; solder.	Some people who drink water containing antimony well in excess of the MCL over many years could experience increases in blood cholesterol and decreases in blood sugar.
Arsenic (ppb)	10.010	1000	110.	10	Erosion of natural deposits; Runoff from orchards; Runoff from glass and electronics production wastes.	Some people who drink water containing arsenic in excess of the MCL over many years could experience skin damage or problems with their circulatory system, and may have an increased risk of getting cancer.
Asbestos (MFL)	7 MFL		7	7	Decay of asbestos cement water mains; production wastes; erosion of natural deposits.	Some people who drink water containing asbestos in excess of the MCL over many years may have an increased risk of developing benign intestinal polyps.
Barium (ppm)	2		2	2	Discharge of drilling wastes; Discharge from	Some people who drink water containing barium in excess of the MCL over

Contaminant (units)	Traditional MCL in mg/L	To convert for CCR, multiply by	MCL in CCR units	MCLG	Major sources in drinking water	Health effects language
Beryllium (ppb)	.004	1000	4	4	metal refineries; Erosion of natural deposits. Discharge from metal refineries and coal-burning factories; Discharge from electrical, aerospace, and defense industries	many years could experience an increase in their blood pressure. Some people who drink water containing beryllium well in excess of the MCL over many years could develop intestinal lesions
Bromate (ppb)	.010	1000	10	0	By-product of drinking water chlorination.	Some people who drink water containing bromate in excess of the MCL over many years may have an increased risk of getting cancer.
Cadmium (ppb)	.005	1000	5	5	Corrosion of galvanized pipes; Erosion of natural deposits; Discharge from metal refineries; Runoff from waste batteries and paints.	Some people who drink water containing cadmium in excess of the MCL over many years could experience kidney damage.
Chloramines (ppm)	MRDL = 4		MRDL = 4	MRDLG = 4	Water additive used to control microbes.	Some people who use water containing chloramines well in excess of the MRDL could experience irritating to their eyes and nose. Some people who drink water containing chloramines well in excess of the MRDL could experience stomach discomfort or anemia.
Chlorine (ppm)	MRDL = 4		MRDL = 4	MRDLG = 4	Water additive used to control microbes	Some people who use water containing chlorine well in excess of the MRDL could experience irritating effects to their eyes and nose. Some people who drink water containing chlorine well in excess of the MRDL could experience stomach discomfort.
Chlorine dioxide (ppb)	MRDL = .8	1000	MRDL = 800	MRDLG = 800	Water additive used to control microbes	Some infants and young children who drink water containing chlorine dioxide in excess of the MRDL could experience nervous system effects. Similar effects may occur in fetuses of pregnant women who drink water containing chlorine dioxide in excess of the MRDL. Some

Contaminant (units)	Traditional MCL in mg/L	To convert for CCR, multiply by	MCL in CCR units	MCLG	Major sources in drinking water	Health effects language
Chlorite (ppm)	1		1	0.8	By-product of drinking water chlorination.	people may experience anemia. Some infants and young children who drink water containing chlorite in excess of the MCL could experience nervous system effects. Similar effects may occur in fetuses of pregnant women who drink water containing chlorite in excess of the MCL. Some people may experience anemia.
Chromium (ppb)	.1	1000	100	100	Discharge from steel and pulp mills; Erosion of Natural deposits.	Some people who use water containing chromium well in excess of the MCL over many years could experience allergic dermatitis.
Copper (ppm)	AL=1.3		AL=1.3	1.3	Corrosion of household plumbing. Erosion of natural deposits.	Copper is an essential nutrient, but some people who drink water containing copper in excess of the action level over a relatively short amount of time could experience gastrointestinal distress. Some people who drink water containing copper in excess of the action level over many years could suffer liver or kidney damage. People with Wilson's Disease should consult their personal doctor.
Cyanide (ppb)	2	1000	200	200	Discharge from steel/metal factories; Discharge from plastic and fertilizer factories.	Some people who drink water containing cyanide well in excess of the MCL over many years could experience nerve damage or problems with their thyroid.
Fluoride (ppm)	4		4	4	Erosion of natural deposits; Water additive which promotes strong teeth Discharge from fertilizer and aluminum factories	Some people who drink water containing fluoride in excess of the MCL over many years could get bone disease, including pain and tenderness of the bones. Fluoride in drinking water at half the MCL or more may cause mottling of children's teeth, usually in children less than nine years old. Mottling, also known as dental fluorosis, may include brown staining and/or pitting

Contaminant (units)	Traditional MCL in mg/L	To convert for CCR, multiply by	MCL in CCR units	MCLG	Major sources in drinking water	Health effects language
Lead	AL=.015	1000	AL=15	0	Corrosion of household plumbing systems; Erosion of natural deposits	of the teeth, and occurs only in developing teeth before they erupt from the gums. Exposure to lead in drinking water can cause serious health effects in all age groups. Infants and children can have decreases in IQ and attention span. Lead exposure can lead to new learning and behavior problems or exacerbate existing learning and behavior problems. The children of women who are exposed to lead before or during pregnancy can have increased risk of these adverse health effects. Adults can have increased risks of heart disease, high blood pressure, kidney or nervous system problems.
Mercury [inorganic] (ppb)	.002	1000	2	2	Erosion of natural deposits; discharge from refineries and factories; Runoff from landfills; Runoff from cropland.	Some people who drink water containing inorganic mercury well in excess of the MCL over many years could experience kidney damage
Nitrate (ppm)	10		10	10	Runoff from fertilizer use; Leaching from septic tanks, sewage; Erosion of natural deposits.	Infants below the age of six months who drink water containing nitrate in excess of the MCL could become seriously ill and, if untreated, may die. Symptoms include shortness of breath and blue baby syndrome.
Nitrite (ppm)	1		1	1	Runoff from fertilizer use; Leaching from septic tanks sewage; Erosion of natural deposits	Infants below the age of six months who drink water containing nitrite in excess of the MCL could become seriously ill and, if untreated, may die. Symptoms include shortness of breath and blue baby syndrome.
Selenium (ppb)	.05	1000	50	50	Discharge from petroleum and metal refineries; Erosion of natural deposits; Discharge from mines.	Selenium is an essential nutrient. However, some people who drink water containing selenium in excess of the MCL over many years could experience hair or fingernail losses, numbness in fingers or toes, or

Contaminant (units)	Traditional MCL in mg/L	To convert for CCR, multiply by	MCL in CCR units	MCLG	Major sources in drinking water	Health effects language
Thallium (ppb)	.002	1000	2	0.5	Leaching from ore-processing sites; Discharge from electronics, glass, and drug factories.	problems with their circulation Some people who drink water containing thallium in excess of the MCL over many years could experience hair loss, changes in their blood, or problems with their kidneys, intestines, or liver.
Synthetic organic contaminants including pesticides and herbicides:						
2,4-D (ppb)	.07	1000	70	70	Runoff from herbicide used on row crops.	Some people who drink water containing the weed killer 2,4-D well in excess of the MCL over many years could experience problems with their kidneys, liver, or adrenal glands.
2,4,5-TP vex](ppb)	[Sil-.05	1000	50	50	Residue of banned herbicide	Some people who drink water containing silvex in excess of the MCL over many years could experience liver problems.
Acrylamide	TT		TT	0	Added to water during sewage/wastewater treatment.	Some people who drink water containing high levels of acrylamide over a long period of time could have problems with their nervous system or blood, and may have risk of getting cancer.
Alachlor (ppb)	.002	1000	2	0	Runoff from herbicide used on row crops.	Some people who drink water containing alachlor in excess of the MCL over many years could have problems with their eyes, liver, kidneys, or spleen, or experience anemia, and may have an increased risk of getting cancer.
Atrazine (ppb)	.003	1000	3	3	Runoff from herbicide used on row crops.	Some people who drink water containing atrazine well in excess of the MCL over many years could experience problems with their cardiovascular system or reproductive difficulties.
Benzo(a)pyrene [PAH] (nanograms/l).	.0002	1,000,000	200	0	Leaching from linings of water storage tanks distribution lines.	Some people who drink water containing benzo(a)pyrene in excess of the MCL over many years may experience reproductive difficulties and may have an in-

Contaminant (units)	Traditional MCL in mg/L	To convert for CCR, multiply by	MCL in CCR units	MCLG	Major sources in drinking water	Health effects language
Carbofuran (ppb)	.04	1000	40	40	Leaching of soil fumigant used on rice and alfalfa.	Increased risk of getting cancer. Some people who drink carbofuran in excess of the MCL over many years could experience problems with their blood, or nervous or reproductive systems.
Chlordane (ppb)	.002	1000	2	0	Residue of banned pesticide	Some people who drink water containing chlordane in excess of the MCL over many years could experience problems with their liver or nervous system, and may have an increased risk of getting cancer.
Dalapon (ppb)	.2	1000	200	200	Runoff from herbicide used on rights of way.	Some people who drink water containing dalapon well in excess of the MCL over many years could experience minor kidney changes.
Di(2-ethylhexyl) adipate (ppb).	.4	1000	400	400	Discharge from chemical factories.	Some people who drink water containing di(2-ethylhexyl) adipate well in excess of the MCL over many years could experience toxic effects such as weight loss, liver enlargement or possible reproductive difficulties.
Di(2-ethylhexyl) phthalate (ppb).	.006	1000	6	0	Discharge from rubber and chemical factories.	Some people who drink water containing di(2-ethylhexyl) phthalate well in excess of the MCL over many years may have problems with their liver, or experience reproductive difficulties, and may have an increased risk of getting cancer.
Dibromochloropropane (ppt)	.0002	1,000,000	200	0	Runoff/leaching from soil fumigant used on soybeans, cotton, pineapples, and orchards.	Some people who drink water containing DBCP in excess of the MCL over many years could experience reproductive problems and may have an increased risk of getting cancer.
Dinoseb (ppb)	.007	1000	7	7	Runoff from herbicide used on soybeans and vegetables.	Some people who drink water containing dinoseb well in excess of the MCL over many years could experience reproductive difficulties.
Diquat (ppb)	.02	1000	20	20	Runoff from herbicide use.	Some people who drink water containing diquat in

Contaminant (units)	Traditional MCL in mg/L	To convert for CCR, multiply by	MCL in CCR units	MCLG	Major sources in drinking water	Health effects language
Dioxin [2,3,7,8-TCDD] (ppq)	.00000003	1,000,000,000	30	0	Emissions from waste incineration and other combustion; Discharge from chemical factories.	excess of the MCL over many years could get cataracts. Some people who drink water containing dioxin in excess of the MCL over many years could experience reproductive difficulties and may have an increased risk of getting cancer.
Endothall (ppb)	.1	1000	100	100	Runoff from herbicide use.	Some people who drink water containing endothall in excess of the MCL over many years could experience problems with their stomach or intestines.
Endrin (ppb)	.002	1000	2	2	Residue of banned insecticide.	Some people who drink water containing endrin in excess of the MCL over many years could experience liver problems.
Epichlorohydrin.	TT		TT	0	Discharge from industrial chemical factories; An impurity of some water treatment chemicals.	Some people who drink water containing high levels of epichlorohydrin over a long period of time could experience stomach problems, and may have an increased risk of getting cancer.
Ethylene dibromide (ppt)	.00005	1,000,000	50	0	Discharge from petroleum refineries.	Some people who drink water containing ethylene dibromide in excess of the MCL over many years could experience problems with their liver, stomach, reproductive system, or kidneys, and may have an increased risk of getting cancer.
Glyphosate (ppb)	.7	1000	700	700	Runoff from herbicide use	Some people who drink water containing glyphosate in excess of the MCL over many years could experience problems with their kidneys or reproductive difficulties.
Heptachlor (ppt)	.0004	1,000,000	400	0	Residue of banned pesticide.	Some people who drink water containing heptachlor in excess of the MCL over many years could experience liver damage and may have an increased risk of getting cancer.
Heptachlor epoxide (ppt)	.0002	1,000,000	200	0	Breakdown of heptachlor.	Some people who drink water containing heptachlor

Contaminant (units)	Traditional MCL in mg/L	To convert for CCR, multiply by	MCL in CCR units	MCLG	Major sources in drinking water	Health effects language
Hexachlorobenzene (ppb)	.001	1000	1	0	Discharge from metal refineries and agricultural chemical factories.	epoxidein excess of the MCL over many years could experience liver damage, and may have an increased risk of getting cancer. Some people who drink water containing Hexachlorobenzene in excess of the MCL over many years could experience problems with their liver or kidneys, or adverse reproductive effects and may have an increased risk of getting cancer
Hexachlorocyclopentadiene (ppb)	.05	1000	50	50	Discharge from chemical factories	Some people who drink water containing hexachlorocyclopentadiene well in excess of the MCL over many years could experience problems with their kidneys or stomach.
Lindane (ppt)	.0002	1,000,000	200	200	Runoff/leaching from insecticide used on cattle, lumber, gardens.	Some people who drink water containing lindane in excess of the MCL over many years could experience problems with their kidneys or liver.
Methoxychlor (ppb)	.04	1000	40	40	Runoff/leaching from insecticide used on fruits, vegetables, alfalfa, livestock.	Some people who drink water containing methoxychlor in excess of the MCL over many years could experience reproductive difficulties
Oxamyl [Vydate] (ppb)	.2	1000	200	200	Runoff/leaching from insecticide used on apples potatoes and tomatoes.	Some people who drink water containing oxamyl in excess of the MCL over many years could experience slight nervous system effects.
PCBs [Polychlorinated biphenyls] (ppt).	.0005	1,000,000	500	0	Runoff from landfills Discharge of waste chemicals	Some people who drink water containing PCBs in excess of the MCL over many years could experience changes in their skin, problems with their thymus gland, immune deficiencies, or reproductive or nervous system difficulties, and may have an increased risk of getting cancer.
Pentachlorophenol (ppb)	.001	1000	1	0	Discharge from wood preserving factories	Some people who drink water containing pentachlorophenol in excess of the MCL over many years could

Contaminant (units)	Traditional MCL in mg/L	To convert for CCR, multiply by	MCL in CCR units	MCLG	Major sources in drinking water	Health effects language
Picloram (ppb)	.5	1000	500	500	Herbicide runoff	experience problems with their liver or kidneys, and may have an increased risk of getting cancer. Some people who drink water containing picloram in excess of the MCL over many years could experience problems with their liver.
Simazine (ppb)	.004	1000	4	4	Herbicide runoff	Some people who drink water containing simazine in excess of the MCL over many years could experience problems with their blood.
Toxaphene (ppb)	.003	1000	3	0	Runoff/leaching from insecticide used on cotton and cattle.	Some people who drink water containing toxaphene in excess of the MCL over many years could have problems with their kidneys, liver, or thyroid, and may have an increased risk of getting cancer.
Volatile organic contaminants:						
Benzene (ppb)	.005	1000	5	0	Discharge from factories; Leaching from gas storage tanks and landfills.	Some people who drink water containing benzene in excess of the MCL over many years could experience anemia or a decrease in blood platelets, and may have an increased risk of getting cancer.
Carbon tetrachloride (ppb)	.005	1000	5	0	Discharge from chemical plants and other industrial activities.	Some people who drink water containing carbon tetrachloride in excess of the MCL over many years could experience problems with their liver and may have an increased risk of getting cancer.
Chlorobenzene (ppb)	.1	1000	100	100	Discharge from chemical and agricultural chemical factories	Some people who drink water containing chlorobenzene in excess of the MCL over many years could experience problems with their liver or kidneys.
o-Dichlorobenzene (ppb)	.6	1000	600	600	Discharge from industrial chemical	Some people who drink water containing o-dichlorobenzene well in excess of the MCL over liver, kidneys, or circulatory systems.

Contaminant (units)	Traditional MCL in mg/L	To convert for CCR, multiply by	MCL in CCR units	MCLG	Major sources in drinking water	Health effects language
p-Dichlorobenzene (ppb)	.075	1000	75	75	Discharge from industrial chemical factories	Some people who drink water containing p-dichlorobenzene in excess of the MCL over many years could experience anemia, damage to their liver, kidneys, or spleen, or changes in their blood.
1,2-Dichloroethane (ppb)	.005	1000	5	0	Discharge from industrial chemical factories.	Some people who drink water containing 1,2-dichloroethane in excess of the MCL over many years may have an increased risk of getting cancer
1,1-Dichloroethylene (ppb)	.007	1000	7	7	Discharge from industrial chemical factories.	Some people who drink water containing 1,1-dichloroethylene in excess of the MCL over many years could experience problems with their liver.
cis-1,2-Dichloroethylene (ppb)	.07	1000	70	70	Discharge from industrial chemical factories.	Some people who drink water containing cis-1,2-dichloroethylene in excess of the MCL over many years could experience problems with their liver.
trans-1,2-Dichloroethylene (ppb).	.1	1000	100	10	Discharge from industrial chemical factories.	Some people who drink water containing trans-1,2-dichloroethylene well in excess of the MCL over many years could experience problems with their liver.
Dichloromethane (ppb)	.005	1000	5	0	Discharge from pharmaceutical and chemical factories	Some people who drink water containing dichloromethane in excess of the MCL over many years could have liver problems and may have an increase risk of getting cancer.
1,2-Dichloropropane (ppb)	.005	1000	5	0	Discharge from industrial chemical factories.	Some people who drink water containing 1,2-Dichloropropane excess of the MCL over many years may have an increased risk of getting cancer.
Ethylbenzene (ppb)	.7	1000	700	700	Discharge from petroleum refineries.	Some people who drink water containing ethylbenzene well in excess of the MCL over many years could experience problems with their liver or kidneys.
Haloacetic Acids (HAA) (ppb).	.060	1000	60	N/A	By-product of drinking water disinfection	Some people who drink water containing haloacetic

Contaminant (units)	Traditional MCL in mg/L	To convert for CCR, multiply by	MCL in CCR units	MCLG	Major sources in drinking water	Health effects language
Styrene (ppb)	.1	1000	100	100	Discharge from rubber and plastic factories and leaching from landfills.	acids in excess of the MCL over many years may have an increased risk of getting cancer. Some people who drink water containing styrene well in excess of the MCL over many years could have problems with their liver, kidneys or circulatory system.
Tetrachloroethylene (ppb)	.005	1000	5	0	Discharge from factories and dry cleaners.	Some people who drink water containing tetrachloroethylene in excess of the MCL over many years could have problems with their liver, and may have an increased risk of getting cancer.
1,2,4-Trichlorobenzene (ppb)	.07	1000	70	70	Discharge from textile-finishing factories.	Some people who drink water containing 1,2,4-trichlorobenzene well in excess of the MCL over many years could experience changes in their adrenal glands.
1,1,1-Trichloroethane (ppb)	.2	1000	200	200	Discharge from metal degreasing sites and other factories.	Some people who drink water containing 1,1,1-trichloroethane in excess of the MCL over many years could experience problems with their liver, nervous system, or circulatory system.
1,1,2-Trichloroethane (ppb).	.005	1000	5	3	Discharge from industrial chemical factories.	Some people who drink water containing 1,1,2-trichloroethane well in excess of the MCL over many years could have problems with their liver, kidneys, or immune systems.
Trichloroethylene (ppb)	.005	1000	5	0	Discharge from metal degreasing sites and other factories	Some people who drink water containing trichloroethylene in excess of the MCL over many years could experience problems with their liver and may have an increased risk of getting cancer.
TTHMs [Total trihalomethanes] (ppb)	0.10/.080	1000	100/80	N/A	By-product of drinking water disinfection.	Some people who drink water containing trihalomethanes in excess of the MCL over many years may experience problems with their liver, kidneys, or central nervous systems,

Contaminant (units)	Traditional MCL in mg/L	To convert for CCR, multiply by	MCL in CCR units	MCLG	Major sources in drinking water	Health effects language
Toluene (ppm)	1		1	1	Discharge from petroleum factories.	and may have an increased risk of getting cancer. Some people who drink water containing toluene well in excess of the MCL over many years could have problems with their nervous system, kidneys, or liver.
Vinyl Chloride (ppb)	.002	1000	2	0	Leaching from PVC piping; Discharge from plastics factories.	Some people who drink water containing vinyl chloride in excess of the MCL over many years may have an increased risk of getting cancer.
Xylenes (ppm)	10		10	10	Discharge from petroleum factories; Discharge from chemical factories.	Some people who drink water containing xylenes in excess of the MCL over many years could experience damage to their nervous system.

Key:

AL=Action Level

MCLG=Maximum Contaminant Level Goal

MRDL=Maximum Residual Disinfectant Level mrem/year=millirems per year (a measure of radiation absorbed by the body)

N/A=Not Applicable

pCi/l=picocuries per liter (a measure of radioactivity)

ppb=parts per billion, or micrograms per liter (µg/l)

ppq=parts per quadrillion, or picograms per liter

Appendix D to R.61-58.12 - endnotes

†These arsenic values are effective January 23, 2006. Until then, the MCL is 0.05 mg/L and there is no MCLG.

‡ Until March 31, 2016

‡ Beginning April 1, 2016

MCL=Maximum Contaminant Level

MFL=million fibers per liter

MRDLG=Maximum Residual Disinfectant Level Goal

NTU=Nephelometric Turbidity Units (a measure of water clarity)

ppm=parts per million, or milligrams per liter (mg/L)

ppt=parts per trillion, or nanograms per liter

TT=Treatment Technique

HISTORY: Added by State Register Volume 25, Issue No. 9, eff September 28, 2001. Amended by State Register Volume 26, Issue No. 12, eff December 27, 2002; State Register Volume 27, Issue No. 9, eff September 26, 2003; State Register Volume 32, Issue No. 4, eff April 25, 2008; State Register Volume 38, Issue No. 9, Doc. No. 4469, eff September 26, 2014; SCSR 46-12 Doc. No. 5135, eff December 23, 2022.

61-58.13. Disinfectant Residuals, Disinfection Byproducts, and Disinfection Byproduct Precursors (Stage 1 Disinfectants and Disinfection Byproducts Rule).

A. Applicability.

This regulation establishes criteria and requirements for the control of disinfectants, disinfection byproducts and disinfection byproduct precursors for community water systems (CWSs) and non-transient, non-community water systems (NTNCWSs) which add a chemical disinfectant to the water in any part of the drinking water treatment process. In addition, this regulation establishes criteria and requirements for the control of chlorine dioxide for non-community water systems (NCWSs) that use chlorine dioxide as a disinfectant or oxidant in any part of the drinking water treatment process.

B. General Requirements

(1) The requirements of this regulation constitute national primary drinking water regulations. This regulation establishes criteria under which community water systems (CWSs) and non-transient, non-community water systems (NTNCWSs) which add a chemical disinfectant to the water in any part of the drinking water treatment process must modify their practices to meet MCLs and MRDLs in R.61-58.5.P and R.61-58.5.Q, respectively, and must meet the treatment technique requirements for disinfection byproduct precursors in Section F of this regulation.

In addition, this regulation establishes criteria under which transient non-community water systems (NCWSs) that use chlorine dioxide as a disinfectant or oxidant must modify their practices to meet the MRDL for chlorine dioxide in R.61-58.5.Q.

(2) Compliance Dates—Unless otherwise noted, systems must comply with the requirements of this regulation as follows:

(a) CWSs and NTNCWSs that use a surface water source or a ground water source under the influence of surface water which serve 10,000 or more persons must comply with this regulation beginning January 1, 2002. CWSs and NTNCWSs that use a surface water source or a ground water source under the influence of surface water which serve fewer than 10,000 persons and systems using only ground water not under the direct influence of surface water must comply with this regulation beginning January 1, 2004.

(b) Transient NCWSs that use a surface water source or a ground water source under the influence of surface water which serve 10,000 or more persons and using chlorine dioxide as a disinfectant or oxidant must comply with any requirements for chlorine dioxide and chlorite in this regulation beginning January 1, 2002. Transient NCWSs that use a surface water source or a ground water source under the influence of surface water which serve fewer than 10,000 persons and use chlorine dioxide as a disinfectant or oxidant and systems that use only ground water not under the direct influence of surface water and use chlorine dioxide as a disinfectant or oxidant must comply with any requirements for chlorine dioxide and chlorite in this regulation beginning January 1, 2004.

(3) Each CWSs and NTNCWSs regulated under paragraph (1) of this section must be operated by a certified operator of appropriate grade.

(4) Control of Disinfectant Residuals—Notwithstanding the MRDLs in R.61-58.5.Q, systems may increase residual disinfectant levels in the distribution system of chlorine or chloramines (but not chlorine dioxide) to a level and for a time necessary to protect public health, to address specific microbiological contamination problems caused by circumstances such as, but not limited to, distribution line breaks, storm run-off events, source water contamination events, or cross-connection events.

(5) Analytical Methods—Analyses used to determine compliance under this regulation shall be conducted using EPA-approved methods and adhering to EPA approved procedures and minimum reporting levels listed in 40 CFR 141.131.

(6) Certified Laboratory—Analyses under this regulation for disinfection byproducts must be conducted by a certified laboratory, except as specified in paragraph (7) of this section.

(7) A party approved by the Department must measure daily chlorite samples at the entrance to the distribution system.

(8) Disinfection Residuals—A party approved by the Department must measure residual disinfectant concentration.

(9) Additional Analyses—A party approved by the Department must measure the following parameters where required for compliance with this regulation:

- (a) Alkalinity
- (b) Bromide
- (c) Total Organic Carbon
- (d) Specific Ultraviolet Absorbance (SUVA)
- (e) pH

C. Monitoring Requirements.

(1) General Requirements

(a) Systems must take all samples during normal operating conditions.

(b) Systems may consider multiple wells drawing water from a single aquifer as one treatment plant for determining the minimum number of TTHM and HAA5 samples required, with Department approval in accordance with criteria developed by the Department and agreed to by the Administrator.

(c) Failure to monitor in accordance with the monitoring plan required under paragraph (6) of this section is a monitoring violation.

(d) Failure to monitor will be treated as a violation for the entire period covered by the annual average where compliance is based on a running annual average of monthly or quarterly samples or averages and the system's failure to monitor makes it impossible to determine compliance with MCLs or MRDLs.

(e) Systems may use only data collected under the provisions of this regulation to qualify for reduced monitoring.

(2) Monitoring Requirements for Disinfection Byproducts.

(a) TTHMs and HAA5—At least twenty-five (25) percent of all samples collected each quarter shall be at locations representing maximum residence time in the distribution system. Remaining samples shall be collected from locations representative of at least average residence time in the distribution systems and representing the entire distribution system, taking into account number of persons served, different sources of water and different treatment methods. The minimum number of samples required shall be determined based on the source of supply and the populations served by a public water system.

(i) CWSs and NTNCWSs that use a surface water source or a ground water source under the influence of surface water which serve 10,000 or more persons must collect samples as follows:

(A) Routine Monitoring—A minimum of four (4) water samples per treatment plant per quarter in accordance with paragraph (2)(a) of this section.

(B) Reduced Monitoring—If the system has a source water annual average TOC level, before any treatment, less than 4.0 mg/l and a TTHM annual average less than 0.040 mg/l and HAA5 annual average less than 0.030 mg/l, then the minimum number of samples required may be reduced to one (1) sample per treatment plant per quarter at a distribution system location reflecting maximum residence time.

(C) Systems on a reduced monitoring schedule may remain on that reduced schedule as long as the average of all samples taken in the year (for systems which must monitor quarterly) or the result of the sample (for systems which must monitor no more frequently than annually) is no more than 0.060 mg/L and 0.045 mg/L for TTHMs and HAA5, respectively. Systems that do not meet these levels must resume monitoring at the frequency identified in paragraph (2)(a)(i)(A) of this section in the quarter immediately following the monitoring period in which the system exceeds 0.060 mg/L and 0.045 mg/L for TTHMs and HAA5, respectively.

(D) The system may be returned to routine monitoring at any time at the Department's discretion.

(ii) CWSs and NTNCWSs that use a surface water source or a ground water source under the influence of surface water which serve from 500 to 9,999 persons must collect samples as follows:

(A) Routine Monitoring—A minimum of one (1) water sample per treatment plant per quarter at a location representing maximum residence time in the distribution system.

(B) Reduced Monitoring—If the system has a source water annual average TOC level, before any treatment, less than 4.0 mg/l and a TTHM annual average less than 0.040 mg/l and HAA5 annual average less than 0.030 mg/l, then the minimum number of samples required may be reduced to one (1) sample per treatment plant per year during a month of warmest water temperature at a distribution system location reflecting maximum residence time.

(C) Systems on a reduced monitoring schedule may remain on that reduced schedule as long as the average of all samples taken in the year (for systems which must monitor quarterly) or the result of the sample (for systems which must monitor no more frequently than annually) is no more than 0.060 mg/L and 0.045 mg/L for TTHMs and HAA5, respectively. Systems that do not meet these levels must resume monitoring at the frequency identified in paragraph (2)(a)(ii)(A) of this section in the quarter immediately following the monitoring period in which the system exceeds 0.060 mg/L and 0.045 mg/L for TTHMs and HAA5, respectively.

(D) The system may be returned to routine monitoring at any time at the Department's discretion.

(iii) CWSs and NTNCWSs that use a surface water source or a ground water source under the influence of surface water which serve less than 500 persons must collect samples as follows:

(A) Routine Monitoring—A minimum of one water sample per treatment plant per year during a month of warmest water temperature at a location representing maximum residence time in the distribution system.

(B) Reduced Monitoring—There is no reduced monitoring allowed for these systems

(C) Increased Monitoring—If the sample (or average of annual samples, if more than one is taken) exceeds the MCL, the system must increase monitoring to one sample per treatment plant per quarter, taken at a point reflecting the maximum residence time in the distribution system, until the system meets criteria in paragraph (2)(a)(iii)(D) of this section.

(D) Systems on increased monitoring may return to routine monitoring if, after at least one year of monitoring their TTHM annual average is less than or equal to 0.060 mg/L and their HAA5 annual average is less than or equal to 0.045 mg/L.

(iv) CWSs and NTNCWSs that use only ground water not under the influence of surface water which serve 10,000 or more persons and use a chemical disinfectant must collect samples as follows:

(A) Routine Monitoring—A minimum of one water sample per treatment plant per quarter at a location representing maximum residence time in the distribution system.

(B) Reduced Monitoring—If the system has a TTHM annual average less than 0.040 mg/l and HAA5 annual average less than 0.030 mg/l, then the minimum number of samples required may be reduced to one (1) sample per treatment plant per year during a month of warmest water temperature at a distribution system location reflecting maximum residence time.

(C) Systems on a reduced monitoring schedule may remain on that reduced schedule as long as the average of all samples taken in the year (for systems which must monitor quarterly) or the result of the sample (for systems which must monitor no more frequently than annually) is no more than 0.060 mg/L and 0.045 mg/L for TTHMs and HAA5, respectively. Systems that do not meet these levels must resume monitoring at the frequency identified in paragraph (2)(a)(iv)(A) of this section in the quarter immediately following the monitoring period in which the system exceeds 0.060 mg/L and 0.045 mg/L for TTHMs and HAA5, respectively.

(D) The system may be returned to routine monitoring at any time at the Department's discretion.

(v) CWSs and NTNCWSs that use only ground water not under the influence of surface water which serve less than 10,000 persons and use a chemical disinfectant must collect samples as follows:

(A) Routine Monitoring—A minimum of one (1) water sample per treatment plant per year during a month of warmest water temperature at a location representing maximum residence time in the distribution system.

(B) Increased Monitoring—If the sample taken, or average of annual samples if more than one (1) sample is taken, exceeds the MCL, the system must increase monitoring to one sample per treatment plant per quarter, taken at a location representing the maximum residence time in the distribution system, until the system meets the criteria in paragraph (2)(a)(v)(F) of this section for reduced monitoring.

(C) Reduced Monitoring—If the system has a TTHM annual average less than 0.040 mg/l and HAA5 annual average less than 0.030 mg/l for two (2) consecutive years, or a TTHM annual average less than 0.020 mg/l and HAA5 annual average less than 0.015 mg/l for one (1) year, then the minimum number of samples required may be reduced to one sample per treatment plant per three (3) year cycle taken during a month of warmest water temperature at a distribution system location reflecting maximum residence time, with the three (3) year cycle beginning on January 1 following the quarter in which the system qualifies for reduced monitoring.

(D) Systems on a reduced monitoring schedule may remain on that reduced schedule as long as the average of all samples taken in the year is no more than 0.060 mg/L and 0.045 mg/L for TTHMs and HAA5, respectively. Systems that do not meet these levels must resume monitor-

ing at the frequency identified in paragraph (v)(A) of this section in the quarter immediately following the monitoring period in which the system exceeds 0.060 mg/L and 0.045 mg/L for TTHMs and HAA5, respectively. If either the TTHM annual average is greater than 0.080 mg/L or the HAA5 annual average is greater than 0.060 mg/L, the system must go to the increased monitoring identified in paragraph (v)(B) of this section in the quarter immediately following the monitoring period in which the system exceeds the 0.080 mg/L or 0.060 mg/L for TTHMs or HAA5 respectively.

(E) The system may be returned to routine monitoring at any time at the Department's discretion.

(F) Systems on increased monitoring may return to routine monitoring if, after at least one (1) year of monitoring their TTHM annual average is less than or equal to 0.060 mg/L and their HAA5 annual average is less than or equal to 0.045 mg/L.

(vi) Monitoring requirements for source water TOC.

In order to qualify for reduced monitoring for TTHM and HAA5 under paragraph C(2)(a)(i)(B) or C(2)(a)(ii)(B) of this section, Subpart H systems not monitoring under the provisions of paragraph C(4) of this section must take monthly TOC samples every 30 days at a location prior to any treatment, beginning April 1, 2008 or earlier, if specified by the Department. In addition to meeting other criteria for reduced monitoring in paragraph C(2)(a)(i)(B) or C(2)(a)(ii)(B) of this section, the source water TOC running annual average must be less than or equal to 4.0 mg/L (based on the most recent four quarters of monitoring) on a continuing basis at each treatment plant to reduce or remain on reduced monitoring for TTHM and HAA5. Once qualified for reduced monitoring for TTHM and HAA5 under paragraph C(2)(a)(i)(B) or C(2)(a)(ii)(B) of this section, a system may reduce source water TOC monitoring to quarterly TOC samples taken every 90 days at a location prior to any treatment.

(b) Chlorite. Community and non-transient, non-community water systems using chlorine dioxide, for disinfection or oxidation, must conduct monitoring for chlorite.

(i) Routine Monitoring.

(A) Daily monitoring. Systems must take daily samples at the entrance to the distribution system. For any daily sample that exceeds the chlorite MCL, the system must take additional samples in the distribution system the following day at the locations required by R.61-58.13.C(2)(b)(ii) in addition to the sample required at the entrance to the distribution system.

(B) Monthly monitoring. Systems must take a three-sample set each month in the distribution system. The system must take one sample at each of the following locations: near the first customer, at a location representative of average residence time, and at a location reflecting the maximum residence time in the distribution system. Any additional routine sampling must be conducted in the same manner (as three-sample sets, at the specified locations). The system may use the results of additional monitoring conducted under R.61-58.13.C(2)(b)(ii) to meet the requirement for this monitoring.

(ii) Additional monitoring. On each day following a routine sample monitoring result that exceeds the chlorite MCL at the entrance to the distribution system, the system is required to take three chlorite distribution system samples at the following locations: as close to the first customer as possible, in a location representative of average residence time, and as close to the end of the distribution system as possible (reflecting maximum residence time in the distribution system).

(iii) Reduced monitoring.

(A) Chlorite monitoring at the entrance to the distribution system required by R.61-58.13.C(2)(b)(i)(A) may not be reduced.

(B) Chlorite monitoring in the distribution system required by R.61-58.13.C(2)(b)(i)(B) may be reduced to one three-sample set per quarter after one year of monitoring where no individual chlorite sample taken in the distribution system under R.61-58.13.C(2)(b)(i)(B) has exceeded the chlorite MCL and the system has not been required to conduct monitoring under R.61-58.13.C(2)(b)(ii). The system may remain on the reduced monitoring schedule until either of the three individual chlorite samples taken quarterly in the distribution system under

R.61-58.13.C(2)(b)(i)(B) exceeds the chlorite MCL or the system is required to conduct monitoring under R.61-58.13.C(2)(b)(ii), at which time, the system must revert to routine monitoring.

(c) Bromate

(i) Routine monitoring. Community and non-transient, non-community systems using ozone, for disinfection or oxidation, must take one sample per month for each treatment plant in the system using ozone. Systems must take samples monthly at the entrance to the distribution system while the ozonation system is operating under normal conditions.

(ii) Reduced Monitoring

(A) Until March 31, 2009, Systems required to analyze for bromate may reduce monitoring from monthly to once per quarter, if the system demonstrates that the average source water bromide concentration is less than 0.05 mg/L based upon representative monthly bromide measurements for one year. The system may remain on reduced bromate monitoring until the running annual average source water bromide concentration, computed quarterly, is equal to or greater than 0.05 mg/L based upon representative monthly measurements. If the running annual average source water bromide concentration is greater than or equal to 0.05 mg/L, the system must resume routine monitoring required by R.61-58.13.C(2)(c)(i).

(B) Beginning April 1, 2009, systems may no longer use the provisions of R.61-58.C(2)(c)(ii)(A) to qualify for reduced monitoring. A system required to analyze for bromate may reduce monitoring from monthly to quarterly, if the system's running annual average bromate concentration is less than or equal to 0.0025 mg/L based on monthly bromate measurements under R.61-58.13.C(2)(c)(i) for the most recent four quarters, with samples analyzed using analytical methods identified in 40 CFR 141.132 (b)(3)(ii)(B) (1-04-06 edition). If a system has qualified for reduced bromate monitoring under R.61-58.13.C(2)(c)(ii)(A), that system may remain on reduced monitoring as long as the running annual average of quarterly bromate samples is less than or equal to 0.0025 mg/L based on samples analyzed using analytical methods identified in 40 CFR 141.132 (b)(3)(ii)(B) (1-04-06 edition). If the running annual average bromate concentration is greater than 0.0025 mg/L, the system must resume routine monitoring required by R.61-58.13.C(2)(c)(i).

(3) Monitoring requirements for disinfectant residuals.

(a) Chlorine and Chloramines.

(i) Routine Monitoring—Until March 31, 2016, community and non-transient non-community water systems that use chlorine or chloramines must measure the residual disinfectant level in the distribution system at the same point in the distribution system and at the same time as total coliforms are sampled, as specified in R.61-58.5.G. Beginning April 1, 2016, community and non-transient non-community water systems that use chlorine or chloramines must measure the residual disinfectant level in the distribution system at the same point in the distribution system and at the same time as total coliforms are sampled, as specified in R.61-58.17.E through R.61-68.17.I. Systems that use a surface water source or a ground water source under the influence of surface water may use the results of residual disinfectant concentration sampling conducted under R.61-58.10.F(2)(f) for unfiltered systems or R.61-58.10.F(3)(c) for systems which filter, in lieu of taking separate samples.

(ii) Reduced Monitoring—Monitoring may not be reduced.

(b) Chlorine Dioxide.

(i) Routine Monitoring—CWSs, NTNCWSs, and TNCWSs that use chlorine dioxide for disinfection or oxidation must take daily samples at the entrance to the distribution system. For any daily sample that exceeds the MRDL, the system must take samples in the distribution system the following day at the locations required by paragraph (3)(b)(ii) of this section, in addition to the sample required at the entrance to the distribution system.

(ii) Additional Monitoring—On each day following a routine sample monitoring result that exceeds the MRDL, the system is required to take three chlorine dioxide distribution system samples. If chlorine dioxide or chloramines are used to maintain a disinfectant residual in the distribution system, or if chlorine is used to maintain a disinfectant residual in the distribution system and there are no disinfection addition points after the entrance to the distribution system (i.e., no booster chlorination), the system must take three samples as close to the first customer as

possible, at intervals of at least six hours. If chlorine is used to maintain a disinfectant residual in the distribution system and there are one or more disinfection addition points after the entrance to the distribution system (i.e., booster chlorination), the system must take one sample at each of the following locations; as close to the first customer as possible, in a location representative of average residence time, and as close to the end of the distribution system as possible (reflecting maximum residence time in the distribution system).

(iii) Reduced Monitoring—Chlorine dioxide monitoring may not be reduced.

(4) Monitoring Requirements for Disinfection Byproduct Precursors (DBPP).

(a) Routine Monitoring—Surface water systems and ground water systems under the influence of surface water which use conventional filtration treatment must monitor each treatment plant for Total Organic Carbon (TOC) no later than the point of combined filter effluent turbidity monitoring and representative of the treated water. All systems required to monitor under this paragraph must also monitor for TOC in the source water prior to any treatment at the same time as monitoring for TOC in the treated water. These samples (source water and treated water) are referred to as paired samples. At the same time as the source water sample is taken, systems must monitor for alkalinity in the source water prior to any treatment. Systems must take one paired sample and one source water alkalinity sample per month per plant at a time representative of normal operating conditions and influent water quality.

(b) Reduced Monitoring—Surface water systems and ground water systems under the influence of surface water with an average treated water TOC of less than 2.0 mg/L for two consecutive years, or less than 1.0 mg/L for one year, may reduce monitoring for both TOC and alkalinity to one paired sample and one source water alkalinity sample per plant per quarter. The system must revert to routine monitoring in the month following the quarter when the annual average treated water TOC ≥ 2.0 mg/L.

(5) Bromide—Systems required to analyze for bromate may reduce bromate monitoring from monthly to once per quarter, if the system demonstrates that the average source water bromide concentration is less than 0.05 mg/L based upon representative monthly measurements for one year. The system must continue bromide monitoring to remain on reduced bromate monitoring.

(6) Monitoring Plans—Each system required to monitor under this regulation must develop and implement a monitoring plan. The system must maintain the plan and make it available for inspection by the Department and the general public no later than 30 days following the applicable compliance dates in R.61–58.13(B)(2). All surface water systems and ground water systems under the influence of surface water serving more than 3300 people must submit a copy of the monitoring plan to the Department no later than the date of the first report required under R.61–58.13(E). The Department may also require the plan to be submitted by any other system. After review, the Department may require changes in any plan elements. The plan must include at least the following elements.

(a) Specific locations and schedules for collecting samples for any parameters included in this regulation.

(b) How the system will calculate compliance with MCLs, MRDLs, and treatment techniques.

(c) If approved for monitoring as a consecutive system, or if providing water to a consecutive system, under the provisions of R.61–58.5(X), the sampling plan must reflect the entire distribution system.

D. Compliance Requirements.

(1) General Requirements.

(a) Where compliance is based on a running annual average of monthly or quarterly samples or averages and the system fails to monitor for TTHM, HAA5, or bromate, this failure to monitor will be treated as a monitoring violation for the entire period covered by the annual average. Where compliance is based on a running annual average of monthly or quarterly samples or averages and the system's failure to monitor makes it impossible to determine compliance with MRDLs for chlorine and chloramines, this failure to monitor will be treated as a monitoring violation for the entire period covered by the annual average.

(b) All samples taken and analyzed under the provisions of this regulation must be included in determining compliance, even if that number is greater than the minimum required.

(c) If, during the first year of monitoring under R.61-58.13(C), any individual quarter's average will cause the running annual average of that system to exceed the MCL, the system is out of compliance at the end of that quarter.

(2) Compliance Requirements.

(a) TTHMs and HAA5.

(i) For systems monitoring quarterly, compliance with MCLs in R.61-58.5.P must be based on a running annual arithmetic average, computed quarterly, of quarterly arithmetic averages of all samples collected by the system as prescribed in Section C(2)(a) above.

(ii) For systems monitoring less frequently than quarterly, systems demonstrate MCL compliance if the average of samples taken that year under the provisions of Section C(2)(a) above, does not exceed the MCLs in R.61-58.5(P). If the average of these samples exceeds the MCL, the system must increase monitoring to once per quarter per treatment plant and such a system is not in violation of the MCL until it has completed one year of quarterly monitoring, unless the result of fewer than four (4) quarters of monitoring will cause the running annual average to exceed the MCL, in which case the system is in violation at the end of that quarter. Systems required to increase monitoring frequency to quarterly monitoring must calculate compliance by including the sample which triggered the increased monitoring plus the following three (3) quarters of monitoring.

(iii) If the running annual arithmetic average of quarterly averages covering any consecutive four (4) quarter period exceeds the MCL, the system is in violation of the MCL and must notify the public pursuant to R.61-58.6 in addition to reporting to the Department pursuant to Section E above.

(iv) If a PWS fails to complete four (4) consecutive quarters of monitoring, compliance with the MCL for the last four (4) quarter compliance period must be based on an average of the available data.

(b) Bromate

Compliance must be based on a running annual arithmetic average, computed quarterly, of monthly samples (or, for months in which the system takes more than one sample, the average of all samples taken during the month) collected by the system as prescribed by R.61-58.13(C)(2)(c). If the average of samples covering any consecutive four-quarter period exceeds the MCL, the system is in violation of the MCL and must notify the public pursuant to R.61-58.6, in addition to reporting to the Department pursuant to R.61-58.13(E). If a PWS fails to complete 12 consecutive months' monitoring, compliance with the MCL for the last four-quarter compliance period must be based on an average of the available data.

(c) Chlorite.

Compliance must be based on an arithmetic average of each three sample set taken in the distribution system as prescribed by R.61-58.13(C)(2)(b)(i)(B) and R.61-58.13(C)(2)(b)(ii). If the arithmetic average of any three sample set exceeds the MCL, the system is in violation of the MCL and must notify the public pursuant to R.61-58.6, in addition to reporting to the Department pursuant to R.61-58.13(E).

(3) Disinfectant Residuals

(a) Chlorine and Chloramines.

(i) Compliance must be based on a running annual arithmetic average, computed quarterly, of monthly averages of all samples collected by the system under Section C(3)(a) above. If the average covering any consecutive four (4) quarter period exceeds the MRDL, the system is in violation of the MRDL and must notify the public pursuant to R.61-58.6, in addition to reporting to the Department pursuant to Section E below.

(ii) In cases where systems switch between the use of chlorine and chloramines for residual disinfection during the year, compliance must be determined by including together all monitoring results of both chlorine and chloramines in calculating compliance. Reports submitted pursuant to Section E below must clearly indicate which residual disinfectant was analyzed for each sample.

(b) Chlorine Dioxide.

(i) Acute Violations - Compliance must be based on consecutive daily samples collected by the system under Section C(3)(b) above. If any daily sample taken at the entrance to the distribution system exceeds the MRDL, and on the following day one (or more) of the three (3) samples taken in the distribution system exceed the MRDL, the system is in violation of the MRDL and must take immediate corrective action to lower the level of chlorine dioxide below the MRDL and must notify the public pursuant to the procedures for acute health risks in R.61-58.6.E in addition to reporting to the Department pursuant to Section E(3) below. Failure to take samples in the distribution system the day following an exceedance of the chlorine dioxide MRDL at the entrance to the distribution system will also be considered an MRDL violation and the system must notify the public of the violation in accordance with the provisions for acute violations under R.61-58.6.E in addition to reporting to the Department pursuant to Section E(3) below.

(ii) Non-acute Violations - Compliance must be based on consecutive daily samples collected by the system under Section C(3)(b) above. If any two (2) consecutive daily samples taken at the entrance to the distribution system exceed the MRDL and all distribution system samples taken are below the MRDL, the system is in violation of the MRDL and must take corrective action to lower the level of chlorine dioxide below the MRDL at the point of sampling and will notify the public pursuant to the procedures for Non-acute health risks in R.61-58.6.E in addition to reporting to the Department pursuant to Section E(3) below. Failure to monitor at the entrance to the distribution system the day following an exceedance of the chlorine dioxide MRDL at the entrance to the distribution system is also an MRDL violation and the system must notify the public of the violation in accordance with the provisions for Non-acute violations under R.61-58.6.E in addition to reporting to the Department pursuant to Section E(3) below.

(4) Disinfection Byproduct Precursors - Compliance must be determined as specified by Section F(3) below. Systems may begin monitoring to determine whether Step 1 TOC removals can be met twelve (12) months prior to the compliance date for the system. This monitoring is not required and failure to monitor during this period is not a violation. However, any system that does not monitor during this period, and then determines in the first twelve (12) months after the compliance date that it is not able to meet the Step 1 requirements in Section F(2)(b) below and must therefore apply for alternate minimum TOC removal (Step 2) requirements, is not eligible for retroactive approval of alternate minimum TOC removal (Step 2) requirements as allowed pursuant to Section F(2)(c) below and is in violation. Systems may apply for alternate minimum TOC removal (Step 2) requirements any time after the compliance date. For systems required to meet Step 1 TOC removals, if the value calculated under Section F(3)(a)(iv) below, is less than 1.00, the system is in violation of the treatment technique requirements and must notify the public pursuant to R.61-58.6.E, in addition to reporting to the Department pursuant to R.61-58.13.E(4).

E. Reporting and Recordkeeping Requirements

(1) Systems required to sample quarterly or more frequently must report to the Department within 10 days after the end of each quarter in which samples were collected, notwithstanding the provisions of R.61-58.6. Systems required to sample less frequently than quarterly must report to the Department within 10 days after the end of each monitoring period in which samples were collected.

(2) Disinfection Byproducts - Systems must report the following information:

(a) Systems monitoring for TTHM and HAA5 under the requirements of R.61-58.13.C(2) on a quarterly or more frequent basis must report:

(i) The number of samples taken during the last quarter.

(ii) The location, date, and result of each sample taken during the last quarter.

(iii) The arithmetic average of all samples taken in the last quarter.

(iv) The annual arithmetic average of the quarterly arithmetic averages of this section for the last four (4) quarters.

(v) Whether, based on Section D(2)(a) above, the MCL was violated.

(b) Systems monitoring for TTHMs and HAA5 under the requirements of R.61-58.13.C(2) less frequently than quarterly (but at least annually) must report

(i) The number of samples taken during the last year.

(ii) The location, date, and result of each sample taken during the last monitoring period.

- (iii) The arithmetic average of all samples taken over the last year.
 - (iv) Whether, based on Section D(2)(a) above, the MCL was violated.
- (c) Systems monitoring for TTHMs and HAA5 under the requirements of R.61-58.13.C(2) less frequently than annually must report:
 - (i) The location, date, and result of each sample taken.
 - (ii) Whether, based on Section D(2)(a) above, the MCL was violated.
- (d) Systems monitoring for chlorite under the requirements of R.61-58.13.C(2) must report:
 - (i) The number of entry point samples taken each month for the last three (3) months.
 - (ii) The location, date, and result of each sample (both entry point and distribution system) taken during the last quarter.
 - (iii) For each month in the reporting period, the arithmetic average of all samples taken in each three (3) samples set taken in the distribution system.
 - (iv) Whether, based on Section D(2)(c) above, the MCL was violated, and in which month, and how many times it was violated each month.
- (e) System monitoring for bromate under the requirements of R.61-58.13.C(2) must report:
 - (i) The number of samples taken during the last quarter.
 - (ii) The location, date, and result of each sample taken during the last quarter.
 - (iii) The arithmetic average of the monthly arithmetic averages of all samples taken in the last year.
 - (iv) Whether, based on Section D(2)(b) above, the MCL was violated.
- (3) Disinfectants - Systems must report the following information:
 - (a) Systems monitoring for chlorine or chloramines under the requirements of R.61-58.13.C(3) must report:
 - (i) The number of samples taken during each month of the last quarter.
 - (ii) The monthly arithmetic average of all samples taken in each month for the last twelve (12) months.
 - (iii) The arithmetic average of all monthly averages for the last twelve (12) months.
 - (iv) Whether, based on Section D(3)(a) above, the MRDL was violated.
 - (b) Systems monitoring for chlorine dioxide under the requirements of R.61-58.13.C(3) must report:
 - (i) The dates, results, and locations of samples taken during the last quarter.
 - (ii) Whether, based on Section D(3)(b) above, the MRDL was violated.
 - (iii) Whether the MRDL was exceeded in any two (2) consecutive daily samples and whether the resulting violation was acute or Non-acute.
- (4) Disinfection byproduct precursors and enhanced coagulation or enhanced softening - Systems must report the following information:
 - (a) System monitoring monthly or quarterly for TOC under the requirements of R.61-58.13.C(4) and required to meet the enhanced coagulation or enhanced softening requirements in R.61-58.13.F(2)(b) or (c) must report:
 - (i) The number of paired (source water and treated water) samples taken during the last quarter.
 - (ii) The location, date, and results of each paired sample and associated alkalinity taken during the last quarter.
 - (iii) For each month in the reporting period that paired samples were taken, the arithmetic average of the percent reduction of TOC for each paired sample and the required TOC percent removal.
 - (iv) Calculations for determining compliance with the TOC percent removal requirements, as provided in R.61-58.13.F(3)(a).

(v) Whether the system is in compliance with the enhanced coagulation or enhanced softening percent removal requirements in R.61-58.13.F(2) for the last four (4) quarters.

(b) System monitoring monthly or quarterly for TOC under the requirements of R.61-58.13(C)(4) and meeting one or more of the alternative compliance criteria in R.61-58.13(F)(1)(a) or (b) must report:

(i) The alternative compliance criterion that the system is using.

(ii) The number of paired samples taken during the last quarter.

(iii) The location, date, and result of each paired sample and associated alkalinity taken during the last quarter.

(iv) The running annual arithmetic average based on monthly averages (or quarterly samples) of source water TOC for systems meeting a criterion in R.61-58.13(F)(1)(a)(i) or (iii) or of treated water TOC for systems meeting the criterion in R.61-58.13(F)(1)(a)(ii).

(v) The running annual arithmetic average based on monthly averages (or quarterly samples) of source water SUVA for systems meeting the criterion in R.61-58.13.F(1)(a)(v) or of treated water SUVA for systems meeting the criterion in R.61-58.13.F(1)(a)(vi).

(vi) The running annual average of source water alkalinity for systems meeting the criterion in R.61-58.13.F(1)(a)(iii) and of treated water alkalinity for systems meeting the criterion in R.61-58.13.F(1)(b)(i).

(vii) The running annual average for both TTHM and HAA5 for systems meeting the criterion in R.61-58.13.F(1)(a)(iii) or (iv).

(viii) The running annual average of the amount of magnesium hardness removal (as CaCO_3 , in mg/L) for systems meeting the criterion in R.61-58.13.F(1)(b)(ii).

(ix) Whether the system is in compliance with the particular alternative compliance criterion in R.61-58.13(F)(1)(a) or (b).

(5) The Department may choose to perform calculations and determine whether the treatment technique was met, in lieu of having the system report that information.

F. Treatment technique for control of disinfection byproduct (DBP) precursors.

(1) Systems using surface water or a ground water under the influence of surface water which utilize conventional filtration treatment must operate with enhanced coagulation or enhanced softening to achieve the TOC percent removal levels specified in paragraph (2) of this section unless the system meets at least one of the alternative compliance criteria listed in paragraph (1)(a) or (1)(b) of this section.

(a) Alternative Compliance Criteria for Enhanced Coagulation and Enhanced Softening Systems - Systems using surface water or a ground water under the influence of surface water which utilize conventional filtration treatment may use the alternative compliance criteria in paragraphs (1)(a)(i) through (vi) of this section to comply with this section in lieu of complying with paragraph (2) of this section. Systems must still comply with monitoring requirements in R.61-58.13.C(4).

(i) The system's source water TOC level, measured according to EPA approved methods specified in 40 CFR 141.131(d)(3), is less than 2.0 mg/L, calculated quarterly as a running annual average.

(ii) The system's treated water TOC level, measured according to EPA approved methods specified in 40 CFR 141.131(d)(3), is less than 2.0 mg/L, calculated quarterly as a running annual average.

(iii) The system's source water TOC level, measured as according to EPA approved methods specified in 40 CFR 141.131(d)(3), is less than 4.0 mg/L, calculated quarterly as a running annual average; the source water alkalinity, measured according to EPA approved methods specified in 40 CFR 141.131(d)(1), is greater than 60 mg/L (as CaCO_3), calculated quarterly as a running annual average; and either the TTHM and HAA5 running annual averages are no greater than 0.040 mg/L and 0.030 mg/L, respectively; or prior to the effective date for compliance in Section B(2) above, the system has made a clear and irrevocable financial commitment not later than the effective date for compliance in Section B(2) above, to use of technologies that will limit the levels of TTHMs and HAA5 to no more than 0.040 mg/L and 0.030 mg/L, respectively. Systems must

submit evidence of a clear and irrevocable financial commitment, in addition to a schedule containing milestones and periodic progress reports for installation and operation of appropriate technologies, to the Department for approval not later than the effective date for compliance in Section B(2) above. These technologies must be installed and operating not later than June 30, 2005. Failure to install and operate these technologies by the date in the approved schedule will constitute a violation of National Primary Drinking Water Regulations.

(iv) The TTHM and HAA5 running annual averages are no greater than 0.040 mg/L and 0.030 mg/L, respectively, and the system uses only chlorine for primary disinfection and maintenance of a residual in the distribution system.

(v) The system's source water SUVA, prior to any treatment and measured monthly according to EPA approved methods specified in 40 CFR 141.131(d)(4), is less than or equal to 2.0 L/mg-m, calculated quarterly as a running annual average.

(vi) The system's finished water SUVA, measured monthly according to EPA approved methods specified in 40 CFR 141.131(d)(4), is less than or equal to 2.0 L/mg-m, calculated quarterly as a running annual average.

(b) Additional alternative compliance criteria for softening systems. Systems practicing enhanced softening that cannot achieve the TOC removals required by paragraph (2)(b) of this section may use the alternative compliance criteria in paragraphs (1)(b)(i) and (ii) of this section in lieu of complying with paragraph (2) of this section. Systems must still comply with monitoring requirements in R.61-58.13(C)(4).

(i) Softening that results in lowering the treated water alkalinity to less than 60 mg/L (as CaCO₃), measured monthly according to EPA approved methods specified in 40 CFR § 141.131(d)(1) and calculated quarterly as a running annual average.

(ii) Softening that results in removing at least 10 mg/L of magnesium hardness (as CaCO₃), measured monthly according to 40 CFR 141.131(d)(6) and calculated quarterly as a running annual average.

(2) Enhanced coagulation and enhanced softening performance requirements.

(a) Systems must achieve the percent reduction of TOC specified in paragraph (2)(b) of this section between the source water and the combined filter effluent, unless the Department approves a system's request for alternate minimum TOC removal (Step 2) requirements under paragraph (2)(c) of this section.

(b) Required Step 1 TOC reductions, indicated in the following table, are based upon specified source water parameters measured in accordance with EPA approved methods specified in 40 CFR 141.131(d). Systems practicing softening are required to meet the Step 1 TOC reductions in the far-right column (Source water alkalinity greater than 120 mg/L) for the specified source water TOC:

STEP 1 REQUIRED REMOVAL OF TOC BY ENHANCED COAGULATION AND ENHANCED SOFTENING FOR SURFACE WATER SYSTEMS OR GROUND WATER SYSTEMS UNDER THE INFLUENCE OF SURFACE WATER USING CONVENTIONAL TREATMENT^{a b}

Source-Water TOC, mg/L	Source-Water Alkalinity, mg/L as CaCO ₃		
	0-60	>60-120	>120 ^c
>2.0-4.0	35.0%	25.0%	15.0%
>4.0-8.0	45.0%	35.0%	25.0%
>8.0	50.0%	40.0%	30.0%

^a Systems meeting at least one of the conditions in paragraphs (1)(a)(i) through (vi) of this section are not required to operate with enhanced coagulation.

^b Softening systems meeting one of the alternative compliance criteria in paragraph (1)(b) of this section are not required to operate with enhanced softening.

^c Systems practicing softening must meet the TOC removal requirements in this column.

(c) Systems using surface water or a ground water under the influence of surface water which utilize conventional filtration treatment that cannot achieve the Step 1 TOC removals required by

paragraph (2)(b) of this section due to water quality parameters or operational constraints must apply to the Department, within three (3) months of failure to achieve the TOC removals required by paragraph (2)(b) of this section, for approval of alternative minimum TOC (Step 2) removal requirements submitted by the system. If the Department approves the alternative minimum TOC removal (Step 2) requirements, the Department may make those requirements retroactive for the purposes of determining compliance. Until the Department approves the alternate minimum TOC removal (Step 2) requirements, the system must meet the Step 1 TOC removals contained in paragraph (2)(b) of this section.

(d) Alternate minimum TOC removal (Step 2) requirements. Applications made to the Department by enhanced coagulation systems for approval of alternative minimum TOC removal (Step 2) requirements under paragraph (2)(c) of this section must include, as a minimum, results of bench- or pilot-scale testing conducted under paragraph (2)(d)(i) of this section. The submitted bench-or-pilot scale testing must be used to determine the alternate enhanced coagulation level.

(i) Alternate enhanced coagulation level is defined as: Coagulation at a coagulant dose and pH as determined by the method described in paragraphs (2)(d)(i) through (v) of this section such that an incremental addition of 10 mg/L of alum (or equivalent amount of ferric salt) results in a TOC removal of greater than or equal to 0.3 mg/L. The percent removal of TOC at this point on the “TOC removal versus coagulant dose” curve is then defined as the minimum TOC removal required for the system. Once approved by the Department, this minimum requirement supersedes the minimum TOC removal required by the table in paragraph (2)(b) of this section. This requirement will be effective until such time as the Department approves a new value based on the results of a new bench- or pilot-scale test. Failure to achieve Department-set alternative minimum TOC removal levels is a violation of National Primary Drinking Water Regulations.

(ii) Bench- or pilot-scale testing of enhanced coagulation must be conducted by using representative water samples and adding 10 mg/L increments of alum (or equivalent amounts of ferric salt) until the pH is reduced to a level less than or equal to the enhanced coagulation Step 2 target pH shown in the following table:

ENHANCED COAGULATION STEP 2 TARGET pH

ALKALINITY (mg/L as CaCO ₃)	TARGET pH
0–60	5.5
>60–120	6.3
>120–240	7.0
>240	7.5

(iii) For waters with alkalinities of less than 60 mg/L for which addition of small amounts of alum or equivalent addition of iron coagulant drives the pH below 5.5 before significant TOC removal occurs, the system must add necessary chemicals to maintain the pH between 5.3 and 5.7 in samples until the TOC removal of 0.3 mg/L per 10 mg/L alum added (or equivalent addition of iron coagulant) is reached.

(iv) The system may operate at any coagulant dose or pH necessary (consistent with other NPDWRs) to achieve the minimum TOC percent removal approved under paragraph (2)(c) of this section.

(v) If the TOC removal is consistently less than 0.3 mg/L of TOC per 10 mg/L of incremental alum dose at all dosages of alum (or equivalent addition of iron coagulant), the water is deemed to contain TOC not amenable to enhanced coagulation. The system may then apply to the Department for a waiver of enhanced coagulation requirements.

(3) Compliance Calculations.

(a) Systems using surface water or a ground water under the influence of surface water other than those identified in paragraph (1)(a) or (1)(b) of this section must comply with requirements contained in R.61–58.13.F(2)(b) or (c). Systems must calculate compliance quarterly, beginning after

the system has collected 12 months of data, by determining an annual average using the following method:

(i) Determine actual monthly TOC percent removal, equal to:

$$(1 - (\text{treated water TOC}/\text{source water TOC})) \times 100.$$

(ii) Determine the required monthly TOC percent removal (from either the table in paragraph (2)(b) or from paragraph (2)(c) of this section).

(iii) Divide the value in paragraph (3)(a)(i) of this section by the value in paragraph (3)(a)(ii) of this section.

(iv) Add together the results of paragraph (3)(a)(iii) of this section for the last twelve (12) months and divide by twelve (12).

(v) If the value calculated in paragraph (3)(a)(iv) of this section is less than 1.00, the system is not in compliance with the TOC percent removal requirements.

(b) Systems may use the provisions in paragraphs (3)(b)(i) through (v) of this section in lieu of the calculations in paragraph (3)(a)(i) through (v) of this section to determine compliance with TOC percent removal requirements.

(i) In any month that the system's treated or source water TOC level, measured according to EPA approved methods specified in 40 CFR 141.131(d)(3), is less than 2.0 mg/L, the system may assign a monthly value of 1.0 (in lieu of the value calculated in paragraph (3)(a)(iii) of this section) when calculating compliance under the provisions of paragraph (3)(a) of this section.

(ii) In any month that a system practicing softening removes at least 10 mg/L of magnesium hardness (as CaCO₃), the system may assign a monthly value of 1.0 (in lieu of the value calculated in paragraph (3)(a)(iii) of this section) when calculating compliance under the provisions of paragraph (3)(a) of this section.

(iii) In any month that the system's source water SUVA, prior to any treatment and measured according to EPA approved methods specified in 40 CFR 141.131(d)(4), is less than or equal to 2.0 L/mg-m, the system may assign a monthly value of 1.0 (in lieu of the value calculated in paragraph (3)(a)(iii) of this section) when calculating compliance under the provisions of paragraph (3)(a) of this section.

(iv) In any month that the system's finished water SUVA, measured according to EPA approved methods specified in 40 CFR 141.131(d)(4) (11-8-2006 edition), is less than or equal to 2.0 L/mg-m, the system may assign a monthly value of 1.0 (in lieu of the value calculated in paragraph (3)(a)(iii) of this section) when calculating compliance under the provisions of paragraph (3)(a) of this section.

(v) In any month that a system practicing enhanced softening lowers alkalinity below 60 mg/L (as CaCO₃), the system may assign a monthly value of 1.0 (in lieu of the value calculated in paragraph (3)(a)(iii) of this section) when calculating compliance under the provisions of paragraph (3)(a) of this section.

(c) Systems using surface water or a ground water under the influence of surface water which utilize conventional treatment may also comply with the requirements of this section by meeting the criteria in paragraph (1)(a) or (1)(b) of this section.

(4) Treatment Technique Requirements for DBP Precursors. The Administrator identifies the following as treatment techniques to control the level of disinfection byproduct precursors in drinking water treatment and distribution systems: For Systems using surface water or a ground water under the influence of surface water which utilize conventional treatment, enhanced coagulation or enhanced softening.

HISTORY: Added by State Register Volume 24, Issue No. 2, eff February 25, 2000. Amended by State Register Volume 25, Issue No. 9, eff September 28, 2001; State Register Volume 30, Issue No. 10, eff October 27, 2006; State Register Volume 32, Issue No. 4, eff April 25, 2008; State Register Volume 38, Issue No. 9, Doc. No. 4469, eff September 26, 2014.

61-58.14. Initial Distribution System Evaluations.

A. Applicability.

This part R.61–58.14 applies to community water systems that use a primary or residual disinfectant other than ultraviolet light or delivers water that has been treated with a primary or residual disinfectant other than ultraviolet light. This part also applies to non-transient non-community water systems that serve at least 10,000 people and use a primary or residual disinfectant other than ultraviolet light or delivers water that has been treated with a primary or residual disinfectant other than ultraviolet light.

B. General Requirements.

(1) The requirements of this part R.61–58.14 constitute national primary drinking water regulations. The regulations in this part establish monitoring and other requirements for identifying compliance monitoring locations specified in R.61–58.15 for determining compliance with maximum contaminant levels for total trihalomethanes (TTHM) and haloacetic acids (five)(HAA5). Public water systems must use an Initial Distribution System Evaluation (IDSE) to determine locations with representative high TTHM and HAA5 concentrations throughout their distribution system. IDSEs are used in conjunction with, but separate from, R.61–58.13 compliance monitoring, to identify and select R.61–58.15 compliance monitoring locations.

(2) Schedule - Systems subject to this part must comply with the requirements of this part on the following schedule:

(a) For systems that are not part of a combined distribution system and systems that serve the largest population in the combined distribution system and serve 100,000 people or greater:

(i) The standard monitoring plan or system specific study or 40/30 certification must be submitted to the Department by October 1, 2006.

(ii) The standard monitoring or system specific study must be completed by September 30, 2008.

(iii) The IDSE report must be submitted to the Department by January 1, 2009.

(iv) If, within 12 months after the date identified in paragraph 2(a)(i) of this section, the Department does not approve the submitted plan or notify the system that it has not yet completed its review, the submitted plan may be considered approved and the system must complete standard monitoring or a system specific study no later than the date identified in paragraph 2(a)(ii) of this section.

(v) If, within 3 months after the date identified in R.61–58.14.(2)(a)(iii), the Department does not approve the submitted IDSE report or notify the system that it has not yet completed its review, the submitted report may be considered approved and the system must implement the IDSE recommended monitoring in accordance with R.61–58.15.

(vi) If a system chooses to submit a 40/30 certification, it must be in accordance with R.61-58.14.E.

(b) For systems that are not part of a combined distribution system and systems that serve the largest population in the combined distribution system and serve between 50,000 and 99,999 people:

(i) The standard monitoring plan or system specific study or a 40/30 certification must be submitted to the Department by April 1, 2007.

(ii) The standard monitoring or system specific study must be completed by March 31, 2009.

(iii) The IDSE report must be submitted to the Department by July 1, 2009.

(iv) If, within 12 months after the date identified in paragraph 2(b)(i) of this section, the Department does not approve the submitted plan or notify the system that it has not yet completed its review, the submitted plan may be considered approved and the system must complete standard monitoring or a system specific study no later than the date identified in paragraph 2(b)(ii) of this section.

(v) If, within 3 months after the date identified in R.61–58.14.B(2)(b)(iii), the Department does not approve the submitted IDSE report or notify the system that it has not yet completed its review, the submitted report may be considered approved and the system must implement the IDSE recommended monitoring in accordance with R.61–58.15.

(vi) If a system chooses to submit a 40/30 certification, it must be in accordance with R.61-58.14.E.

(c) For systems that are not part of a combined distribution system and systems that serve the largest population in the combined distribution system and serve between 10,000 and 49,999 people:

(i) The standard monitoring plan or system specific study or 40/30 certification must be submitted to the Department by October 1, 2007.

(ii) The standard monitoring or system specific study must be completed by September 30, 2009.

(iii) The IDSE report must be submitted to the Department by January 1, 2010.

(iv) If, within 12 months after the date identified in paragraph 2(c)(i) of this section, the Department does not approve the submitted plan or notify the system that it has not yet completed its review, the submitted plan may be considered approved and the system must complete standard monitoring or a system specific study no later than the date identified in paragraph 2(c)(ii) of this section.

(v) If, within 9 months after the date identified in R.61-58.14.B(2)(c)(iii), the Department does not approve the submitted IDSE report or notify the system that it has not yet completed its review, the submitted report may be considered approved and the system must implement the IDSE recommended monitoring in accordance with R.61-58.15.

(vi) If a system chooses to submit a 40/30 certification, it must be in accordance with R.61-58.14.E.

(d) For systems that are not part of a combined distribution system and systems that serve the largest population in the combined distribution system and serve less than 10,000 people:

(i) The standard monitoring plan or system specific study or 40/30 certification must be submitted to the Department by April 1, 2008 or a very small system waiver must be granted by the Department by April 1, 2008.

(ii) The standard monitoring or system specific study must be completed by March 31, 2010.

(iii) The IDSE report must be submitted to the Department by July 1, 2010.

(iv) If, within 12 months after the date identified in paragraph 2(d)(i) of this section, the Department does not approve the submitted plan or notify the system that it has not yet completed its review, the submitted plan may be considered approved and the system must complete standard monitoring or a system specific study no later than the date identified in paragraph 2(d)(ii) of this section.

(v) If, within 3 months after the date identified in R.61-58.14.B(2)(d)(iii), the Department does not approve the submitted IDSE report or notify the system that it has not yet completed its review, the submitted report may be considered approved and the system must implement the IDSE recommended monitoring in accordance with R.61-58.15.

(vi) If a system chooses to submit a 40/30 certification, it must be in accordance with R.61-58.14.E.

(e) For systems that are part of a combined distribution system

(i) The standard monitoring plan or system specific study or 40/30 certification must be submitted to the Department at the same time as the system in the combined distribution system with the earliest compliance date.

(ii) The standard monitoring or system specific study must be completed at the same time as the system in the combined distribution system with the earliest compliance date.

(iii) The IDSE report must be submitted to the Department at the same time as the system in the combined distribution system with the earliest compliance date.

(iv) If, within 12 months after the date which is determined by the criteria specified in paragraph 2(e)(i) of this section, the Department does not approve the submitted plan or notify the system that it has not yet completed its review, the submitted plan may be considered approved and the system must complete standard monitoring or a system specific study no later than the date which is determined by the criteria specified in paragraph 2(e)(ii) of this section.

(v) If, within 3 months after the date identified in R.61-58.14.B(2)(e)(iii), the Department does not approve the submitted IDSE report or notify the system that it has not yet completed its

review, the submitted report may be considered approved and the system must implement the IDSE recommended monitoring in accordance with R.61-58.15.

(vi) If a system chooses to submit a 40/30 certification, it must be in accordance with R.61-58.14.E.

(3) For the purpose of the schedule in this section, the Department may determine that the combined distribution system does not include certain consecutive systems based on factors such as receiving water from a wholesale system only on an emergency basis or receiving only a small percentage and small volume of water from a wholesale system. The Department may also determine that the combined distribution system does not include certain wholesale systems based on factors such as delivering water to a consecutive system only on an emergency basis or delivering only a small percentage and small volume of water to a consecutive system.

(4) Systems must conduct standard monitoring that meets the requirements in R.61-58.14.C, or a system specific study that meets the requirements in R.61-58.14.D, or certify to the Department that the system meets 40/30 certification criteria under R.61-58.14.E, or qualify for a very small system waiver under R.61-58.14.F.

(a) Systems must have taken the full complement of TTHM and HAA5 compliance samples required under R.61-58.13 during the period specified in R.61-58.14.E(1) to meet the 40/30 certification criteria in R.61-58.14.E. The system must have taken TTHM and HAA5 samples under R.61-58.13 to be eligible for the very small system waiver in R.61-58.14.F.

(b) Systems that have not taken the required samples must conduct standard monitoring that meets the requirements in R.61-58.14.C, or a system specific study that meets the requirements in R.61-58.14.D.

(5) All analyses used to determine compliance with the requirements in R.61-58.14 must be conducted using only the analytical methods specified in 40 CFR 141.131, or otherwise approved by EPA for monitoring under 40 CFR 141 subpart U.

(6) IDSE results will not be used for the purpose of determining compliance with MCLs in R.61-58.5.P.

C. Standard Monitoring

(1) Standard Monitoring Plan.

For systems that choose to conduct standard monitoring, the standard monitoring plan must comply with paragraphs (1)(a) through (1)(d) of this section. The standard monitoring plan must be prepared and submitted to the Department according to the schedule in section B of this part.

(a) The standard monitoring plan must include a schematic of the system's distribution system (including distribution system entry points and their sources, and storage facilities), with notes indicating locations and dates of all projected standard monitoring, and all projected R.61-58.13 compliance monitoring.

(b) The standard monitoring plan must include justification of standard monitoring location selection and a summary of data relied upon to justify standard monitoring location selection.

(c) The standard monitoring plan must specify the population served and system type (subpart H or ground water).

(d) The system must retain a complete copy of the standard monitoring plan submitted under this section C, including any Department modification of the standard monitoring plan, for as long as the system is required to retain the IDSE report under R.61-58.14.C(3)(d).

(2) Standard Monitoring.

(a) Systems conducting standard monitoring must monitor as indicated in this paragraph (2)(a). Systems must collect dual sample sets at each monitoring location. One sample in the dual sample set must be analyzed for TTHM. The other sample in the dual sample set must be analyzed for HAA5. Systems must collect one monitoring period during the peak historical month for TTHM levels or HAA5 levels or the month of warmest water temperature. Systems must review available compliance, study, or operational data to determine the peak historical month for TTHM or HAA5 levels or warmest water temperature.

(i) Consecutive systems receiving water from a Subpart H source and serving less than 500 people must collect two (2) dual sample sets taken during the peak historical month for TTHM or HAA5 levels or the during the month of warmest water temperature at the following locations:

- (A) One (1) dual sample set near the entry point to the distribution system.
- (B) One (1) dual sample set at a high TTHM location.

(ii) Non-consecutive systems utilizing a Subpart H source and serving less than 500 people must collect two (2) dual sample sets taken during the peak historical month for TTHM or HAA5 levels or the during the month of warmest water temperature at the following locations:

- (A) One (1) dual sample set at a high TTHM location.
- (B) One (1) dual sample set at a high HAA5 location.

(iii) Consecutive systems receiving water from a Subpart H source and serving between 500 and 3,300 people must collect two (2) dual sample sets every 90 days for four (4) consecutive monitoring periods at the following locations:

- (A) One (1) dual sample set near the entry point to the distribution system.
- (B) One (1) dual sample set at a high TTHM location.

(iv) Non-consecutive systems utilizing a Subpart H source and serving between 500 and 3,300 people must collect two (2) dual sample sets every 90 days for four (4) consecutive monitoring periods at the following locations:

- (A) One (1) dual sample set at a high TTHM location.
- (B) One (1) dual sample set at a high HAA5 location.

(v) Consecutive systems receiving water from a Subpart H source or non-consecutive systems utilizing a Subpart H source and serving between 3,301 and 9,999 people must collect four (4) dual sample sets every 90 days for four (4) consecutive monitoring periods at the following locations:

- (A) One (1) dual sample set at the average residence time.
- (B) Two (2) dual sample sets at high TTHM locations.
- (C) One (1) dual sample set at a high HAA5 location.

(vi) Consecutive systems receiving water from a Subpart H source or non-consecutive systems utilizing a Subpart H source and serving between 10,000 and 49,999 people must collect eight (8) dual sample sets every 60 days for six (6) consecutive monitoring periods at the following locations:

- (A) One (1) dual sample set near the entry point to the distribution system.
- (B) Two (2) dual sample sets at average residence time.
- (C) Three (3) dual sample sets at high TTHM locations.
- (D) Two (2) dual sample sets at high HAA5 locations.

(vii) Consecutive systems receiving water from a Subpart H source or non-consecutive systems utilizing a Subpart H source and serving between 50,000 and 249,999 people must collect sixteen (16) dual sample sets every 60 days for six (6) consecutive monitoring periods at the following locations:

- (A) Three (3) dual sample sets near entry points to the distribution system.
- (B) Four (4) dual sample sets at average residence time.
- (C) Five (5) dual sample sets at high TTHM locations.
- (D) Four (4) dual sample sets at high HAA5 locations.

(viii) Consecutive systems receiving water from a Subpart H source or non-consecutive systems utilizing a Subpart H source and serving between 250,000 and 999,999 people must collect twenty-four (24) dual sample sets every 60 days for six (6) consecutive monitoring periods at the following locations:

- (A) Four (4) dual sample sets near entry points to the distribution system.
- (B) Six (6) dual sample sets at average residence time.

(C) Eight (8) dual sample sets at high TTHM locations.

(D) Six (6) dual sample sets at high HAA5 locations.

(ix) Consecutive systems receiving water from a Subpart H source or non-consecutive systems utilizing a Subpart H source and serving between 1,000,000 and 4,999,999 people must collect thirty-two (32) dual sample sets every 60 days for six (6) consecutive monitoring periods at the following locations:

(A) Six (6) dual sample sets near entry points to the distribution system.

(B) Eight (8) dual sample sets at average residence time.

(C) Ten (10) dual sample sets at high TTHM locations.

(D) Eight (8) dual sample sets at high HAA5 locations.

(x) Consecutive systems receiving water from a Subpart H source or non-consecutive systems utilizing a Subpart H source and serving 5,000,000 or more people must collect forty (40) dual sample sets every 60 days for six (6) consecutive monitoring periods at the following locations:

(A) Eight (8) dual sample sets near entry points to the distribution system.

(B) Ten (10) dual sample sets at average residence time.

(C) Twelve (12) dual sample sets at high TTHM locations.

(D) Ten (10) dual sample sets at high HAA5 locations.

(xi) Consecutive systems receiving water from a ground water source and serving less than 500 people must collect two (2) dual sample sets taken during the peak historical month for TTHM or HAA5 levels or the during the month of warmest water temperature at the following locations:

(A) One (1) dual sample set near the entry point to the distribution system.

(B) One (1) dual sample set at a high TTHM location.

(xii) Non-consecutive systems utilizing a ground water source and serving less than 500 people must collect two (2) dual sample sets taken during the peak historical month for TTHM or HAA5 levels or the during the month of warmest water temperature at the following locations:

(A) One (1) dual sample set at a high TTHM location.

(B) One (1) dual sample set at a high HAA5 location.

(xiii) Consecutive systems receiving water from a ground water source or non-consecutive systems utilizing a ground water source and serving between 500 and 9,999 people must collect two (2) dual sample sets every 90 days for four (4) consecutive monitoring periods at the following locations:

(A) One (1) dual sample set at a high TTHM location.

(B) One (1) dual sample set at a high HAA5 location.

(xiv) Consecutive systems receiving water from a ground water source or non-consecutive systems utilizing a ground water source and serving between 10,000 and 99,999 people must collect six (6) dual sample sets every 90 days for four (4) consecutive monitoring periods at the following locations:

(A) One (1) dual sample set near the entry point to the distribution system.

(B) One (1) dual sample set at average residence time.

(C) Two (2) dual sample sets at high TTHM locations.

(D) Two (2) dual sample sets at high HAA5 locations.

(xv) Consecutive systems receiving water from a ground water source or non-consecutive systems utilizing a ground water source and serving between 100,000 and 499,999 people must collect eight (8) dual sample sets every 90 days for four (4) consecutive monitoring periods at the following locations:

(A) One (1) dual sample set near the entry point to the distribution system.

(B) One (1) dual sample set at average residence time.

(C) Three (3) dual sample sets at high TTHM locations.

(D) Three (3) dual sample sets at high HAA5 locations.

(xvi) Consecutive systems receiving water from a ground water source or non-consecutive systems utilizing a ground water source and serving 500,000 or more people must collect twelve (12) dual sample sets every 90 days for four (4) consecutive monitoring periods at the following locations:

(A) Two (2) dual sample sets near entry points to the distribution system.

(B) Two (2) dual sample sets at average residence time.

(C) Four (4) dual sample sets at high TTHM locations.

(D) Four (4) dual sample sets at high HAA5 locations.

(b) Samples must be taken at locations other than the existing monitoring locations utilized for compliance with R.61-58.13. Monitoring locations must be distributed throughout the distribution system.

(c) If the number of entry points to the distribution system is fewer than the specified number of entry point monitoring locations, excess entry point samples must be replaced equally at high TTHM and HAA5 locations. If there is an odd extra location number, the system must take a sample at a high TTHM location. If the number of entry points to the distribution system is more than the specified number of entry point monitoring locations, the system must take samples at entry points to the distribution system having the highest annual water flows.

(d) Monitoring under this section C may not be reduced.

(3) IDSE Report

The IDSE report must include the elements required in paragraphs (3)(a) through (3)(d) of this section C. The system must submit their IDSE report to the Department according to the schedule in R61-58.14.B(2).

(a) The IDSE report must include all TTHM and HAA5 analytical results from R.61-58.13 compliance monitoring and all standard monitoring conducted during the period of the IDSE as individual analytical results and LRAAs presented in a tabular or spreadsheet format acceptable to the Department. If changed from the standard monitoring plan submitted under paragraph (1) of this section C, the report must also include a schematic of the distribution system, the population served, and system type (subpart H or ground water).

(b) The IDSE report must include an explanation of any deviations from the approved standard monitoring plan.

(c) The IDSE report must recommend and justify compliance monitoring locations for compliance with R.61-58.15 and timing based on the protocol in R.61-58.14.G.

(d) Systems must retain a complete copy of the IDSE report submitted under this section for 10 years after the date that the report is submitted. If the Department modifies the monitoring requirements for compliance with R.51-58.15 that is recommended in the IDSE report or if the Department approves alternative monitoring locations, systems must keep a copy of the Department's notification on file for 10 years after the date of the Department's notification. Systems must make the IDSE report and any Department notification available for review by the Department or the public.

D. System Specific Studies

(1) System Specific Study Plan. For systems that choose to conduct a system specific study, the system specific study plan must be based on either existing monitoring results as required under paragraph (1)(a) of this section or modeling as required under paragraph (1)(b) of this section. The system specific study plan must be prepared and submitted to the Department according to the schedule in section B of this part.

(a) Existing monitoring results. Systems may comply by submitting monitoring results collected before they are required to begin monitoring under section B of this part. The monitoring results and analysis must meet the criteria in paragraphs (1)(a)(i) and (1)(a)(ii) of this section.

(i) Minimum requirements.

(A) TTHM and HAA5 results must be based on samples collected and analyzed in accordance with 40 CFR 141.131. Samples must be collected no earlier than five years prior to the study plan submission date.

(B) The monitoring locations and frequency must meet the conditions identified in this paragraph (1)(a)(i)(B). Each location must be sampled once during the peak historical month for TTHM levels or HAA5 levels or the month of warmest water temperature for every 12 months of data submitted for that location. Monitoring results must include all R.61-58.13 compliance monitoring results plus additional monitoring results as necessary to meet minimum sample requirements.

System Type	Population size category	Number of monitoring locations	Number of TTHM samples	Number of HAA5 samples
Subpart H	Less than 500	3	3	3
Subpart H	500 - 3,300	3	9	9
Subpart H	3,301 - 9,999	6	36	36
Subpart H	10,000 - 49,999	12	72	72
Subpart H	50,000 - 249,999	24	144	144
Subpart H	250,000 - 999,999	36	216	216
Subpart H	1,000,000 - 4,999,999	48	288	288
Subpart H	5,000,000 or greater	60	360	360
Ground Water	Less than 500	3	3	3
Ground Water	500 - 9,999	3	9	9
Ground Water	10,000 - 99,999	12	48	48
Ground Water	100,000 - 499,999	18	72	72
Ground Water	500,000 or greater	24	96	96

(ii) Reporting monitoring results. The information in this paragraph (1)(a)(ii) must be reported.

(A) Systems must report previously collected monitoring results and certify that the reported monitoring results include all compliance and non-compliance results generated during the time period beginning with the first reported result and ending with the most recent results of samples taken for compliance with R.61-58.13.

(B) Systems must certify that the samples were representative of the entire distribution system and that treatment, and distribution system have not changed significantly since the samples were collected.

(C) The system specific study monitoring plan must include a schematic of the distribution system (including distribution system entry points and their sources, and storage facilities), with notes indicating the locations and dates of all completed or planned system specific study monitoring.

(D) The system specific study plan must specify the population served and system type (subpart H or ground water).

(E) The system must retain a complete copy of the specific study plan submitted under this paragraph (1)(a), including any EPA or Department modification of the system specific study plan, for as long as they are required to retain the IDSE report under paragraph 2(g) of this section.

(F) If previously collected data that fully meet the number of samples required under paragraph (1)(a)(i)(B) of this section is submitted by the system and the Department rejects some of the data, the system must either conduct additional monitoring to replace rejected data on a schedule the Department approves or conduct standard monitoring under section R.61-58.14.C.

(b) Modeling. Systems may comply through analysis of an extended period simulation hydraulic model. The extended period simulation hydraulic model and analysis must meet the criteria in this paragraph (1)(b).

(i) Minimum requirements.

(A) The model must simulate 24-hour variation in demand and show a consistently repeating 24-hour pattern of residence time.

(B) The model must represent the criteria listed in paragraphs (1)(b)(i)(B)(1) through (1)(b)(i)(B)(9) of this section.

(1) 75% of pipe volume;

(2) 50% of pipe length;

(3) All pressure zones;

(4) All 12-inch diameter and larger pipes;

(5) All 8-inch and larger pipes that connect pressure zones, influence zones from different sources, storage facilities, major demand areas, pumps, and control valves, or are known or expected to be significant conveyors of water;

(6) All 6-inch and larger pipes that connect remote areas of a distribution system to the main portion of the system;

(7) All storage facilities with standard operations represented in the model;

(8) All active pump stations with controls represented in the model; and

(9) All active control valves.

(C) The model must be calibrated, or have calibration plans, for the current configuration of the distribution system during the period of high TTHM formation potential. All storage facilities must be evaluated as part of the calibration process. All required calibration must be completed no later than 12 months after plan submission.

(ii) Reporting modeling. The system specific study plan must include the information in this paragraph (1)(b)(ii).

(A) Tabular or spreadsheet data demonstrating that the model meets requirements in paragraph (1)(b)(i)(B) of this section.

(B) A description of all calibration activities undertaken, and if calibration is complete, a graph of predicted tank levels versus measured tank levels for the storage facility with the highest residence time in each pressure zone, and a time series graph of the residence time at the longest residence time storage facility in the distribution system showing the predictions for the entire simulation period (i.e., from time zero until the time it takes to for the model to reach a consistently repeating pattern of residence time).

(C) Model output showing preliminary 24-hour average residence time predictions throughout the distribution system.

(D) Timing and number of samples representative of the distribution system planned for at least one monitoring period of TTHM and HAA5 dual sample monitoring at a number of locations no less than would be required for the system under standard monitoring in section R.61-58.14.C during the historical month of high TTHM. These samples must be taken at locations other than existing R.61-58.13 compliance monitoring locations.

(E) Description of how all requirements will be completed no later than 12 months after the system submits their system specific study plan.

(F) Schematic of the distribution system (including distribution system entry points and their sources, and storage facilities), with notes indicating the locations and dates of all completed system specific study monitoring (if calibration is complete) and all R.61-58.13 compliance monitoring.

(G) Population served and system type (subpart H or ground water).

(H) Systems must retain a complete copy of their system specific study plan submitted under this paragraph (1)(b), including any EPA or Department modification of their system specific study plan, for as long as they are required to retain their IDSE report under paragraph (2)(g) of this section.

(iii) Systems that submit a model that does not fully meet the requirements under paragraph (1)(b) of this section, must correct the deficiencies and respond to EPA's or the Department's inquiries concerning the model. If the system fails to correct deficiencies or respond to inquiries to the Department's satisfaction, the system must conduct standard monitoring under R.61-58.14.C

(2) IDSE report.

The IDSE report must include the elements required in paragraphs (2)(a) through (2)(f) of this section. Systems must submit their IDSE report according to the schedule in R.61-58.14.B(2).

(a) The IDSE report must include all TTHM and HAA5 analytical results from R.61-58.13 compliance monitoring and all system specific study monitoring conducted during the period of the system specific study presented in a tabular or spreadsheet format acceptable to the Department. If changed from the system specific study plan submitted under paragraph (1) of this section, the IDSE report must also include a schematic of the distribution system, the population served, and system type (subpart H or ground water).

(b) If the system used the modeling provision under paragraph (1)(b) of this section, they must include final information for the elements described in paragraph (1)(b)(ii) of this section, and a 24-hour time series graph of residence time for each R.61-58.15 compliance monitoring location selected.

(c) The IDSE report must recommend and justify R.61-58.15 compliance monitoring locations and timing based on the protocol in R.61-58.14.G

(d) The IDSE report must include an explanation of any deviations from the system's approved system specific study plan.

(e) The IDSE report must include the basis (analytical and modeling results) and justification used to select the recommended R.61-58.15 monitoring locations.

(f) Systems may submit their IDSE report in lieu of a system specific study plan on the schedule identified in R.61-58.14.B(2) for submission of the system specific study plan if the system believes that it has the necessary information by the time that the system specific study plan is due. If the system elects this approach, their IDSE report must also include all information required under paragraph (1) of this section.

(g) Systems must retain a complete copy of the IDSE report submitted under this section for 10 years after the date that the IDSE report is submitted. If the Department modifies the monitoring requirements for compliance with R.51-58.15 that are recommended in the IDSE report or if the Department approves alternative monitoring locations, water systems must keep a copy of the Department's notification on file for 10 years after the date of the Department's notification. Systems must make the IDSE report and any Department notification available for review by the Department or the public.

E. 40/30 Certification

(1) Eligibility

Systems are eligible for 40/30 certification if they had no TTHM or HAA5 monitoring violations under R.61-58.13 and no individual sample exceeded 0.040 mg/L for TTHM or 0.030 mg/L for HAA5 during an eight consecutive calendar quarter period beginning no earlier than the date specified in this paragraph (1).

(a) If 40/30 certification is due October 1, 2006, then eligibility for 40/30 certification is based on eight consecutive calendar quarters of results of monitoring for compliance with R.61-58.13 beginning no earlier than January 2004.

(b) If 40/30 certification is due April 1, 2007, then eligibility for 40/30 certification is based on eight consecutive calendar quarters of results of monitoring for compliance with R.61-58.13 beginning no earlier than January 2004.

(c) If 40/30 certification is due October 1, 2007, then eligibility for 40/30 certification is based on eight consecutive calendar quarters of results of monitoring for compliance with R.61-58.13 beginning no earlier than January 2005.

(d) If 40/30 certification is due April 1, 2008, then eligibility for 40/30 certification is based on eight consecutive calendar quarters of results of monitoring for compliance with R.61-58.13 beginning no earlier than January 2005.

(e) If a system is on reduced monitoring under R.61-58.13 and was not required to monitor during the specified monitoring period, eligibility is based on compliance samples taken during the 12 months preceding the specified period.

(2) 40/30 Certification

(a) Systems applying for 40/30 certification must certify to the Department that every individual compliance sample taken under R.61-58.13 during the periods specified in paragraph (1) of this section were less than or equal to 0.040 mg/L for TTHM and less than or equal to 0.030 mg/L for HAA5, and that no TTHM or HAA5 monitoring violations were incurred during the period specified in paragraph (1) of this section.

(b) The Department may require that systems applying for 40/30 certification submit compliance monitoring results, distribution system schematics, and/or recommended R.61-58.15 compliance monitoring locations in addition to their certification. If the system fails to submit the requested information, the Department may require standard monitoring under R.61-58.14.C or a system specific study under R.61-58.14.D

(c) The Department may still require standard monitoring under R.61-58.14.C or a system specific study under R.61-58.14.D even if a system meets the criteria in paragraph (1) of this section.

(d) Systems must retain a complete copy of the 40/30 certification submitted under this section for 10 years after the date that the certification is submitted. Systems must make the certification, all data upon which the certification is based, and any Department notification available for review by the Department or the public.

F. Very Small System Waivers

(1) If a system serves fewer than 500 people and has taken TTHM and HAA5 samples under R.61-58.13, the system is not required to comply with this part R.61-58.14 unless the Department notifies the system that it must conduct standard monitoring under R.61-58.14.C or a system specific study under R.61-58.14.D.

(2) If a system has not taken TTHM and HAA5 samples under R.61-58.13 or if the Department notifies the system that they must comply with the part R.61-58.14, the system must conduct standard monitoring under R.61-58.14.C or a system specific study under R.61-58.14.D.

G. Stage 2 Disinfection Byproducts Rule Compliance Monitoring Location Recommendations.

(1) The IDSE report must include recommendations and justification for where and during what month(s) TTHM and HAA5 monitoring for compliance with requirements of R.61-58.15 should be conducted. Recommendations must be based on the criteria in paragraphs (2) through (5) of this section.

(2) Systems must select the number of monitoring locations specified in the table in this paragraph (2). These recommended locations will be used as R.61-58.15 (Stage 2 Disinfection Byproducts Requirements) routine compliance monitoring locations, unless the Department requires different or additional locations. Monitoring locations should be distributed throughout the distribution system to the extent possible.

Source Water Type	Population size category	Monitoring frequency	Total monitoring locations per monitoring period	Highest TTHM monitoring locations	Highest HAA5 monitoring locations	Existing R.61-58.13 compliance monitoring locations
Subpart H	Less than 500	per year	2	1	1	-
Subpart H	500 - 3,300	per quarter	2	1	1	-
Subpart H	3,301 - 9,999	per quarter	2	1	1	-
Subpart H	10,000 - 49,999	per quarter	4	2	1	1
Subpart H	50,000 - 249,999	per quarter	8	3	3	2
Subpart H	250,000 - 999,999	per quarter	12	5	4	3

Subpart H	1,000,000 - 4,999,999	per quarter	16	6	6	4
Subpart H	5,000,000 or greater	per quarter	20	8	7	5
Ground Water	Less than 500	per year	2	1	1	-
Ground Water	500 - 9,999	per year	2	1	1	-
Ground Water	10,000 - 99,999	per quarter	4	2	1	1
Ground Water	100,000 - 499,999	per quarter	6	3	2	1
Ground Water	500,000 or greater	per quarter	8	3	3	2

(a) All systems must monitor during the month of highest disinfection byproduct (DBP) concentrations.

(b) Systems on quarterly monitoring must take dual sample sets every 90 days at each monitoring location, except for subpart H systems serving 500–3,300. Systems on annual monitoring and subpart H systems serving 500–3,300 are required to take individual TTHM and HAA5 samples (instead of a dual sample set) at the locations with the highest TTHM and HAA5 concentrations, respectively. Only one location with a dual sample set per monitoring period is needed if highest TTHM and HAA5 concentrations occur at the same location, and month, if monitored annually.

(3) Systems must recommend R.61–58.15 compliance monitoring locations based on standard monitoring results, system specific study results, and R.61–58.13 compliance monitoring results. Systems must follow the protocol in paragraphs (3)(a) through (3)(h) of this section. If required to monitor at more than eight locations, a system must repeat the protocol as necessary. If a system does not have existing R.61–58.13 compliance monitoring results or if they do not have enough existing R.61–58.13 compliance monitoring results, they must repeat the protocol, skipping the provisions of paragraphs (3)(c) and (3)(g) of this section as necessary, until the required total number of monitoring locations have been identified.

(a) Location with the highest TTHM LRAA not previously selected as an R.61–58.15 monitoring location.

(b) Location with the highest HAA5 LRAA not previously selected as an R.61–58.15 monitoring location.

(c) Existing R.61–58.13 average residence time compliance monitoring location (maximum residence time compliance monitoring location for ground water systems) with the highest HAA5 LRAA not previously selected as an R.61–58.15 monitoring location.

(d) Location with the highest TTHM LRAA not previously selected as an R.61–58.15 monitoring location.

(e) Location with the highest TTHM LRAA not previously selected as an R.61–58.15 monitoring location.

(f) Location with the highest HAA5 LRAA not previously selected as an R.61–58.15 monitoring location.

(g) Existing R.61–58.13 average residence time compliance monitoring location (maximum residence time compliance monitoring location for ground water systems) with the highest TTHM LRAA not previously selected as a R.61–58.15 monitoring location.

(h) Location with the highest HAA5 LRAA not previously selected as an R.61–58.15 monitoring location.

(4) A system may recommend locations other than those specified in paragraph (3) of this section if they include a rationale for selecting other locations. If the Department approves the alternate locations, the system must monitor at these locations to determine compliance under R.61–58.15.

(5) The recommended schedule must include R.61–58.15 monitoring during the peak historical month for TTHM and HAA5 concentration, unless the Department approves another month. Once the peak historical month has been identified, and if the system is required to conduct routine monitoring at least quarterly, the system must schedule R.61–58.15 compliance monitoring at a regular frequency of every 90 days or fewer.

HISTORY: Added by State Register Volume 30, Issue No. 10, eff October 27, 2006. Amended by State Register Volume 32, Issue No. 4, eff April 25, 2008.

61-58.15. Stage 2 Disinfection Byproducts Requirements.

A. Applicability.

This part R.61-58.15 applies to community water systems and non-transient non-community water systems that uses a primary or residual disinfectant other than ultraviolet light or delivers water that has been treated with a primary or residual disinfectant other than ultraviolet light.

B. General Requirements.

(1) The requirements of this part R.61-58.15 constitute national primary drinking water regulations. The regulations in this part establish monitoring and other requirements for achieving compliance with maximum contaminant levels based on locational running annual averages (LRAA) for total trihalomethanes (TTHM) and haloacetic acids (five)(HAA5), and for achieving compliance with maximum residual disinfectant levels for chlorine and chloramine for certain consecutive systems.

(2) Schedule - Systems subject to this part R.61-58.15 must comply with the requirements of this part on the following schedule:

(a) Systems that are not part of a combined distribution system and systems that serve the largest population in the combined distribution system and serve 100,000 people or greater must comply with this part R.61-58.15 by April 1, 2012.

(b) Systems that are not part of a combined distribution system and systems that serve the largest population in the combined distribution system and serve between 50,000 and 99,999 people must comply with this part R.61-58.15 by October 1, 2012.

(c) Systems that are not part of a combined distribution system and systems that serve the largest population in the combined distribution system and serve between 10,000 and 49,999 people must comply with this part R.61-58.15 by October 1, 2013.

(d) Systems that are not part of a combined distribution system and systems that serve the largest population in the combined distribution system and serve less than 10,000 must comply with this part R.61-58.15 by October 1, 2013 if no *Cryptosporidium* monitoring is required under R.61-58.10.K(2)(a)(iv), or by October 1, 2014 if *Cryptosporidium* monitoring is required under R.61-58.10.K(2)(a)(iv).

(e) Systems that are part of a combined distribution system must comply with this part R.61-58.15 at the same time as the system with the earliest compliance date in the combined distribution system.

(f) The Department may grant systems up to an additional 24 months from the specified date for compliance with MCLs and operational evaluation levels if capital improvements are required to comply with an MCL.

(g) Systems monitoring frequency is specified in R.61-58.15.C(1)(b)

(i) If systems are required to conduct quarterly monitoring, then they must begin monitoring in the first full calendar quarter that includes the compliance date in this paragraph (2).

(ii) If systems are required to conduct monitoring at a frequency that is less than quarterly, then they must begin monitoring in the calendar month recommended in the IDSE report prepared under R.61-58.14.C or R.61-58.14.D or the calendar month identified in the monitoring plan developed under R.61-58.15.D no later than 12 months after the compliance date in this paragraph (2).

(h) If systems are required to conduct quarterly monitoring, then they must make compliance calculations at the end of the fourth calendar quarter that follows the compliance date and at the end of each subsequent quarter (or earlier if the LRAA calculated based on fewer than four quarters of data would cause the MCL to be exceeded regardless of the monitoring results of subsequent quarters). If systems are required to conduct monitoring at a frequency that is less than quarterly, then they must make compliance calculations beginning with the first compliance sample taken after the compliance date.

(i) [Reserved]

(j) For the purpose of the schedule in this paragraph (2), the Department may determine that the combined distribution system does not include certain consecutive systems based on factors such as receiving water from a wholesale system only on an emergency basis or receiving only a small percentage and small volume of water from a wholesale system. The Department may also

determine that the combined distribution system does not include certain wholesale systems based on factors such as delivering water to a consecutive system only on an emergency basis or delivering only a small percentage and small volume of water to a consecutive system.

(3) Monitoring and compliance.

(a) In order for systems that are required to monitor quarterly to comply with MCLs in R.61-58.5.P(2)(b), they must calculate LRAAs for TTHM and HAA5 using monitoring results collected under this part R.61-58.15 and determine that each LRAA does not exceed the MCL. If the system fails to complete four consecutive quarters of monitoring, they must calculate compliance with the MCL based on the average of the available data from the most recent four quarters. If the system takes more than one sample per quarter at a monitoring location, they must average all samples taken in the quarter at that location to determine a quarterly average to be used in the LRAA calculation.

(b) In order for systems required to monitor yearly or less frequently to determine compliance with MCLs in R.61-58.5.P(2)(b), they must determine that each sample taken is less than the MCL. If any sample exceeds the MCL, the system must comply with the requirements of section R.61-58.15.G. If no sample exceeds the MCL, the sample result for each monitoring location is considered the LRAA for that monitoring location.

(4) Systems are in violation of the monitoring requirements for each quarter that a monitoring result would be used in calculating an LRAA if they fail to monitor.

C. Routine Monitoring

(1) Monitoring

(a) If a system submitted an IDSE report, they must begin monitoring at the locations and months recommended in the IDSE report submitted under section R.61-58.14.G following the schedule in R.61-58.15.B(2), unless the Department requires other locations or additional locations after its review. If the system submitted a 40/30 certification under section R.61-58.14.E or they qualified for a very small system waiver under section R.61-58.14.F or they are a non-transient non-community water system serving less than 10,000 people, they must monitor at the location(s) and dates identified in their monitoring plan in R.61-58.13.C(6), updated as required by section R.61-58.15.D.

(b) Systems must monitor at no fewer than the number of locations identified in this paragraph (1)(b).

Source water type	Population size category	Monitoring frequency	Distribution system monitoring locations per monitoring period
Subpart H	Less than 500	per year	2
Subpart H	500 - 3,300	per quarter	2
Subpart H	3,301 - 9,999	per quarter	2
Subpart H	10,000 - 49,999	per quarter	4
Subpart H	50,000 - 249,999	per quarter	8
Subpart H	250,000 - 999,999	per quarter	12
Subpart H	1,000,000 - 4,999,999	per quarter	16
Subpart H	5,000,000 or greater	per quarter	20
Ground water	Less than 500	per year	2
Ground water	500 - 9,999	per year	2
Ground water	10,000 - 99,999	per quarter	4
Ground water	100,000 - 499,999	per quarter	6
Ground water	500,000 or greater	per quarter	8

(i) All systems must monitor during month of highest DBP concentrations.

(ii) Systems on quarterly monitoring must take dual sample sets every 90 days at each monitoring location, except for subpart H systems serving 500-3,300. Systems on annual monitoring and subpart H systems serving 500-3,300 are required to take individual TTHM and

HAA5 samples (instead of a dual sample set) at the locations with the highest TTHM and HAA5 concentrations, respectively. Only one location with a dual sample set per monitoring period is needed if highest TTHM and HAA5 concentrations occur at the same location (and month, if monitored annually).

(c) Undisinfected systems that begin using a disinfectant other than UV light after the dates in R.61-58.14 for complying with the Initial Distribution System Evaluation requirements must consult with the Department to identify compliance monitoring locations for this part R.61-58.15. The systems must then develop a monitoring plan under R.61-58.15.D that includes those monitoring locations.

(2) Analytical Methods - Analyses used to determine compliance with this part R.61-58.15 must be conducted using an approved method listed in 40 CFR 141.131 for TTHM and HAA5 analyses.

(3) Certified Laboratory - Analyses under this part R.61-58.15 for disinfection byproducts must be conducted by a certified laboratory.

D. Stage 2 DBP Monitoring Plans.

(1) Monitoring Plan Development.

(a) Systems must develop and implement a monitoring plan to be kept on file for Department and public review. The monitoring plan must contain the elements in paragraphs (1)(a)(i) through (1)(a)(iv) of this section and be complete no later than the date the system conducts initial monitoring under this part R.61-58.15.

(i) Monitoring locations;

(ii) Monitoring dates;

(iii) Compliance calculation procedures; and.

(iv) Monitoring plans for any other systems in the combined distribution system if the Department has reduced monitoring requirements under the authority granted in 40 CFR 142.16(m).

(b) For systems that were not required to submit an IDSE report under either section R.61-58.14.C or section 61-58.14.D, and do not have sufficient R.61-58.13 monitoring locations to identify the required number of R.61-58.15 compliance monitoring locations indicated in R.61-58.14.G(2), they must identify additional locations by alternating selection of locations representing high TTHM levels and high HAA5 levels until the required number of compliance monitoring locations have been identified. Systems must also provide the rationale for identifying the locations as having high levels of TTHM or HAA5. If a system has more R.61-58.13 monitoring locations than required for R.61-58.15 compliance monitoring in R.61-58.14.G(2), they must identify which locations they will use for R.61-58.15 compliance monitoring by alternating selection of locations representing high TTHM levels and high HAA5 levels until the required number of R.61-58.15 compliance monitoring locations have been identified.

(2) Subpart H systems serving > 3,300 people must submit a copy of the monitoring plan required under this section to the Department prior to the date the system begins initial monitoring under this part R.61-58.15, unless the IDSE report submitted under R.61-58.14 contains all the information required by this section.

(3) Systems may revise their monitoring plan to reflect changes in treatment, distribution system operations and layout (including new service areas), or other factors that may affect TTHM or HAA5 formation, or for Department approved reasons, after consultation with the Department regarding the need for changes and the appropriateness of changes. If a system changes monitoring locations, they must replace existing compliance monitoring locations that have the lowest LRAA with new locations that reflect the current distribution system locations with expected high TTHM or HAA5 levels. The Department may also require modifications in the monitoring plan. Subpart H systems serving > 3,300 people, must submit a copy of their modified monitoring plan to the Department prior to the date they are required to comply with the revised monitoring plan.

E. Reduced Monitoring

(1) Systems may reduce monitoring to the level specified in this paragraph (1) any time the LRAA is less than or equal to 0.040 mg/L for TTHM and less than or equal to 0.030 mg/L for HAA5 at all monitoring locations. Only data collected under the provisions of R.61-58.15 or R.61-58.13 may be used to qualify for reduced monitoring. In addition, the source water annual average TOC level,

before any treatment, must be less than or equal to 4.0 mg/L at each treatment plant treating surface water or ground water under the direct influence of surface water, based on monitoring conducted under either R.61-58.13.C(2)(a)(vi) or R.61-58.13.C(4). Systems on reduced monitoring under this section that are required to monitor quarterly must take dual sample sets every 90 days.

(a) Subpart H systems serving less than 500 people may not reduce monitoring.

(b) Subpart H systems serving between 500 and 3,300 people and meeting the criteria in this paragraph (1) may reduce monitoring to one (1) TTHM sample per year taken at the location and during the quarter with the highest TTHM single measurement, and one (1) HAA5 sample per year taken at the location and during the quarter with the highest HAA5 single measurement. One (1) dual sample set per year may be taken if the highest TTHM and HAA5 measurements occurred at the same location during the same quarter.

(c) Subpart H systems serving between 3,301 and 9,999 people and meeting the criteria in this paragraph (1) may reduce monitoring to one (1) dual sample set per year taken at the location and during the quarter with the highest TTHM single measurement, and one (1) dual sample set per year taken at the location and during the quarter with the highest HAA5 single measurement.

(d) Subpart H systems serving between 10,000 and 49,999 people and meeting the criteria in this paragraph (1) may reduce monitoring to two (2) dual sample sets per quarter taken at the locations with the highest TTHM and HAA5 LRAAs.

(e) Subpart H systems serving between 50,000 and 249,999 people and meeting the criteria in this paragraph (1) may reduce monitoring to four (4) dual sample sets per quarter taken at the locations with the two highest TTHM and two highest HAA5 LRAAs.

(f) Subpart H systems serving between 250,000 and 999,999 people and meeting the criteria in this paragraph (1) may reduce monitoring to six (6) dual sample sets per quarter taken at the locations with the three highest TTHM and three highest HAA5 LRAAs.

(g) Subpart H systems serving between 1,000,000 and 4,999,999 people and meeting the criteria in this paragraph (1) may reduce monitoring to eight (8) dual sample sets per quarter taken at the locations with the four highest TTHM and four highest HAA5 LRAAs.

(h) Subpart H systems serving 5,000,000 or more people and meeting the criteria in this paragraph (1) may reduce monitoring to ten (10) dual sample sets per quarter taken at the locations with the five highest TTHM and five highest HAA5 LRAAs.

(i) Ground water systems serving less than 500 people and meeting the criteria in this paragraph (1) may reduce monitoring to one (1) TTHM sample every third year taken at the location and during the quarter with the highest TTHM single measurement, and one (1) HAA5 sample every third year taken at the location and during the quarter with the highest HAA5 single measurement. One (1) dual sample set every third year may be taken if the highest TTHM and HAA5 measurements occurred at the same location during the same quarter.

(j) Ground water systems serving between 500 and 9,999 people and meeting the criteria in this paragraph (1) may reduce monitoring to one (1) TTHM sample per year taken at the location and during the quarter with the highest TTHM single measurement, and one (1) HAA5 sample per year taken at the location and during the quarter with the highest HAA5 single measurement. One (1) dual sample set per year may be taken if the highest TTHM and HAA5 measurements occurred at the same location during the same quarter.

(k) Ground water systems serving between 10,000 and 99,999 people and meeting the criteria in this paragraph (1) may reduce monitoring to one (1) dual sample set per year taken at the location and during the quarter with the highest TTHM single measurement and one (1) dual sample set per year taken at the location and during the quarter with the highest HAA5 single measurement.

(l) Ground water systems serving between 100,000 and 499,999 people and meeting the criteria in this paragraph (1) may reduce monitoring to two (2) dual sample sets per quarter taken at the locations with the highest TTHM and HAA5 LRAAs.

(m) Ground water systems serving 500,000 or more people and meeting the criteria in this paragraph (1) may reduce monitoring to four (4) dual sample sets per quarter taken at the locations with the two highest TTHM and two highest HAA5 LRAAs.

(2) Systems on reduced monitoring may remain on reduced monitoring as long as the TTHM LRAA is less than or equal to 0.040 mg/L and the HAA5 LRAA is less than or equal to 0.030 mg/L at each monitoring location (for systems with quarterly reduced monitoring) or each TTHM sample is less than or equal to 0.060 mg/L and each HAA5 sample is less than or equal to 0.045 mg/L (for systems with annual or less frequent monitoring). In addition, the source water annual average TOC level, before any treatment, must be less than or equal to 4.0 mg/L at each treatment plant treating surface water or ground water under the direct influence of surface water, based on monitoring conducted under either R.61–58.13.C(2)(a)(vi) or R.61–58.13.C(4).

(3) If the LRAA based on quarterly monitoring at any monitoring location exceeds either 0.040 mg/L for TTHM or 0.030 mg/L for HAA5 or if the annual (or less frequent) sample at any location exceeds either 0.060 mg/L for TTHM or 0.045 mg/L for HAA5, or if the source water annual average TOC level, before any treatment, is greater than 4.0 mg/L at any treatment plant treating surface water or ground water under the direct influence of surface water, the system must resume routine monitoring under R.61-58.15.C or begin increased monitoring if R.61-58.15.G applies.

(4) Systems may be returned to routine monitoring at the Department's discretion.

F. Additional Requirements for Consecutive Systems.

A consecutive system that does not add a disinfectant but delivers water that has been treated with a primary or residual disinfectant other than ultraviolet light, must comply with analytical and monitoring requirements for chlorine and chloramines in R.61–58.13.B and R.61–58.13.C(3)(a) and the compliance requirements in R.61–58.13.D(3)(a) beginning April 1, 2009, unless required earlier by the Department, and report monitoring results under R.61–58.13.E(3).

G. Conditions Requiring Increased Monitoring

(1) If a system is required to monitor at a particular location annually or less frequently than annually under R.61–58.15.C or R.61–58.15.E, they must increase monitoring to dual sample sets once per quarter (taken every 90 days) at all locations if a TTHM sample is greater than 0.080 mg/L or a HAA5 sample is greater than 0.060 mg/L at any location.

(2) A system is in violation of the MCL when the LRAA exceeds the R.61–58.15 MCLs in R.61–58.5.P, calculated based on four consecutive quarters of monitoring (or the LRAA calculated based on fewer than four quarters of data if the MCL would be exceeded regardless of the monitoring results of subsequent quarters). A system is in violation of the monitoring requirements for each quarter that a monitoring result would be used in calculating an LRAA if they fail to monitor.

(3) A system may return to routine monitoring once they have conducted increased monitoring for at least four consecutive quarters and the LRAA for every monitoring location is less than or equal to 0.060 mg/L for TTHM and less than or equal to 0.045 mg/L for HAA5.

H. Operational Evaluation Levels.

(1) A system has exceeded the operational evaluation level at any monitoring location where the sum of the two previous quarters' TTHM results plus twice the current quarter's TTHM result, divided by 4 to determine an average, exceeds 0.080 mg/L, or where the sum of the two previous quarters' HAA5 results plus twice the current quarter's HAA5 result, divided by 4 to determine an average, exceeds 0.060 mg/L.

(2) Operational Evaluations

(a) If a system exceeds the operational evaluation level, they must conduct an operational evaluation and submit a written report of the evaluation to the Department no later than 90 days after being notified of the analytical result that causes them to exceed the operational evaluation level. The written report must be made available to the public upon request.

(b) The operational evaluation must include an examination of system treatment and distribution operational practices, including storage tank operations, excess storage capacity, distribution system flushing, changes in sources or source water quality, and treatment changes or problems that may contribute to TTHM and HAA5 formation and what steps could be considered to minimize future exceedences.

(i) A system may request and the Department may allow them to limit the scope of their evaluation if they are able to identify the cause of the operational evaluation level exceedance.

(ii) A request to limit the scope of the evaluation does not extend the schedule in paragraph (2)(a) of this section for submitting the written report. The Department must approve this limited scope of evaluation in writing and the system must keep that approval with the completed report.

I. Requirements for Remaining on Reduced TTHM and HAA5 Monitoring Based on R.61-58.13 Results.

A system on reduced monitoring under R.61-58.13 may remain on reduced monitoring after the dates identified in R.61-58.15.B for compliance with this subpart only if they qualify for a 40/30 certification under R.61-58.14.E or have received a very small system waiver under R.61-58.14.F, plus they meet the reduced monitoring criteria in R.61-58.15.E(1), and they do not change or add monitoring locations from those used for compliance monitoring under R.61-58.13. If the system's monitoring locations under this part R.61-58.15 differ from the monitoring locations under R.61-58.13, the system may not remain on reduced monitoring after the dates identified R.61-58.15.B for compliance with this part R.61-58.15.

J. Requirements for Remaining on Increased TTHM and HAA5 Monitoring Based on R.61-58.13 Results.

If a system was on increased monitoring under R.61-58.13.C(2)(a), they must remain on increased monitoring until they qualify for a return to routine monitoring under R.61-58.15.G(3). The system must conduct increased monitoring under R.61-58.15.G at the monitoring locations in the monitoring plan developed under R.61-58.15.D beginning at the date identified in R.61-58.15.B for compliance with this part and remain on increased monitoring until they qualify for a return to routine monitoring under R.61-58.15.G(3).

K. Reporting and Recordkeeping Requirements.

(1) Reporting

(a) Systems must report the following information for each monitoring location to the Department within 10 days of the end of any quarter in which monitoring is required:

(i) Number of samples taken during the last quarter.

(ii) Date and results of each sample taken during the last quarter.

(iii) Arithmetic average of quarterly results for the last four quarters for each monitoring location (LRAA), beginning at the end of the fourth calendar quarter that follows the compliance date and at the end of each subsequent quarter. If the LRAA calculated based on fewer than four quarters of data would cause the MCL to be exceeded regardless of the monitoring results of subsequent quarters, the system must report this information to the Department as part of the first report due following the compliance date or anytime thereafter that this determination is made. If a system is required to conduct monitoring at a frequency that is less than quarterly, they must make compliance calculations beginning with the first compliance sample taken after the compliance date, unless they are required to conduct increased monitoring under R.61-58.15.G.

(iv) Whether, based on R.61-58.5.P(2)(b) and this part R.61-58.15, the MCL was violated at any monitoring location.

(v) Any operational evaluation levels that were exceeded during the quarter and, if so, the location and date, and the calculated TTHM and HAA5 levels.

(b) Subpart H systems seeking to qualify for or remain on reduced TTHM/HAA5 monitoring, must report the following source water TOC information for each treatment plant that treats surface water or ground water under the direct influence of surface water to the Department within 10 days of the end of any quarter in which monitoring is required:

(i) The number of source water TOC samples taken each month during last quarter.

(ii) The date and result of each sample taken during last quarter.

(iii) The quarterly average of monthly samples taken during last quarter or the result of the quarterly sample.

(iv) The running annual average (RAA) of quarterly averages from the past four quarters.

(v) Whether the RAA exceeded 4.0 mg/L.

(c) The Department may choose to perform calculations and determine whether the MCL was exceeded or the system is eligible for reduced monitoring in lieu of having the system report that information.

(2) Recordkeeping.

Systems must retain any R.61–58.15 monitoring plans and monitoring results as required by R.61–58.6.D.

HISTORY: Added by State Register Volume 30, Issue No. 10, eff October 27, 2006.

61–58.16. Ground Water Rule.

A. Applicability.

This part R.61–58.16 applies to all public water systems that use ground water except that it does not apply to public water systems that combine all of their ground water with surface water or with ground water under the direct influence of surface water prior to treatment under 40 CFR 141, Subpart H. For the purposes of this part, “ground water system” is defined as any public water system meeting this applicability statement, including consecutive systems receiving finished ground water.

B. General Requirements.

The requirements of R.61–58.16 constitute national primary drinking water regulations. Systems subject to this part must comply with the following requirements:

(1) Sanitary survey information requirements for all ground water systems as described in R.61–58.16.D.

(2) Microbial source water monitoring requirements for ground water systems that do not treat all of their ground water to at least 99.99 percent (4-log) treatment of viruses (using inactivation, removal, or a Department-approved combination of 4-log virus inactivation and removal) before or at the first customer as described in R.61–58.16.E.

(3) Treatment technique requirements, described in R.61–58.16.F, that apply to ground water systems that have fecally contaminated source waters, as determined by source water monitoring conducted under R.61–58.16.E, or that have significant deficiencies that are identified by the Department or that are identified by EPA under the Safe Drinking Water Act section 1445. A ground water system with fecally contaminated source water or with significant deficiencies subject to the treatment technique requirements of R.61–58.16.F must implement one or more of the following corrective action options: correct all significant deficiencies; provide an alternate source of water; eliminate the source of contamination; or provide treatment that reliably achieves at least 4-log treatment of viruses (using inactivation, removal, or a Department-approved combination of 4-log virus inactivation and removal) before or at the first customer.

(4) Ground water systems that provide at least 4-log treatment of viruses (using inactivation, removal, or a Department-approved combination of 4-log virus inactivation and removal) before or at the first customer are required to conduct compliance monitoring to demonstrate treatment effectiveness, as described in R.61–58.16.F(2).

(5) If requested by the Department, ground water systems must provide the Department with any existing information that will enable the Department to perform a hydrogeologic sensitivity assessment. For the purposes of this part R.61–58.16, “hydrogeologic sensitivity assessment” is a determination of whether ground water systems obtain water from hydrogeologically sensitive settings.

C. Compliance Date.

Ground water systems must comply, unless otherwise noted, with the requirements of R.61–58.16 beginning December 1, 2009.

D. Sanitary Surveys For Ground Water Systems.

(1) Ground water systems must provide the Department, at the Department’s request, any existing information that will enable the Department to conduct a sanitary survey.

(2) For the purposes of R.61–58.16, a “sanitary survey,” as conducted by the Department, includes, but is not limited to, an onsite review of the water source(s) (identifying sources of contamination by using results of source water assessments or other relevant information where available), facilities,

equipment, operation, maintenance, and monitoring compliance of a public water system to evaluate the adequacy of the system, its sources and operations and the distribution of safe drinking water.

(3) The sanitary survey must include an evaluation of the applicable components listed in paragraphs R.61-58.16.D(3)(a) through (h).

- (a) Source.
- (b) Treatment including corrosion control treatment and water quality parameters as applicable.
- (c) Distribution system.
- (d) Finished water storage.
- (e) Pumps, pump facilities, and controls.
- (f) Monitoring, reporting, and data verification.
- (g) System management and operation.
- (h) Operator compliance with Department requirements.

E. Ground Water Source Microbial Monitoring and Analytical Methods.

(1) Triggered source water monitoring.

(a) General Requirement. A ground water system must conduct triggered source water monitoring if the conditions identified in paragraphs (1)(a)(i) and either (1)(a)(ii) or 1(a)(iii) of this section exist.

(i) The system does not provide at least 4-log treatment of viruses (using inactivation, removal, or a Department-approved combination of 4-log virus inactivation and removal) before or at the first customer for each ground water source; and either

(ii) The system is notified that a sample collected under R.61-58.5.G(1) is total coliform-positive and the sample is not invalidated under R.61-58.5.G(3) until March 31, 2016, or

(iii) The system is notified that a sample collected under R.61-58.17.E through R.61-58.17.H is total coliform-positive and the sample is not invalidated under R.61-58.17.D(3) beginning April 1, 2016.

(b) Sampling Requirements. A ground water system must collect, within 24 hours of notification of the total coliform-positive sample, at least one ground water source sample from each ground water source in use at the time the total coliform-positive sample was collected under R.61-58.5.G(1) until March 31, 2016, or collected under R.61-58.17.E through R.61-58.17.H beginning April 1, 2016, except as provided in R.61-58.16.E(1)(b)(ii).

(i) The Department may extend the 24-hour time limit on a case-by-case basis if the system cannot collect the ground water source sample within 24 hours due to circumstances beyond its control. In the case of an extension, the Department must specify how much time the system has to collect the sample.

(ii) If approved by the Department, systems with more than one ground water source may meet the requirements of R.61-58.16.E(1)(b) by sampling a representative ground water source or sources. If directed by the Department, systems must submit a triggered source water monitoring plan for Department approval that identifies one or more ground water sources that are representative of each monitoring site in the system's sample siting plan under R.61-58.5.G(1) until March 31, 2016, or under R.61-58.17.D beginning April 1, 2016, and that the system intends to use for representative sampling under this paragraph.

(iii) Until, March 31, 2016, a ground water system serving 1,000 or fewer people may use a repeat sample collected from a ground water source to meet both the requirements of R.61-58.5.G(2) and to satisfy the monitoring requirements of R.61-58.16.E(1)(b) for that ground water source only if the Department approves the use of E.coli as a fecal indicator for source water monitoring under R.61-58.16.E(1). If the repeat sample collected from the ground water source is E.coli-positive, the system must comply with R.61-58.16.E(1)(c).

(iv) Beginning April 1, 2016, a ground water system serving 1,000 or fewer people may use a repeat sample collected from a ground water source to meet both the requirements of R.61-58.17 and to satisfy the monitoring requirements of R.61-58.16.E(1)(b) for that ground water source only if the Department approves the use of E. coli as a fecal indicator for source water monitoring

under R.61-58.16.E(1) and approves the use of a single sample for meeting both the triggered source water monitoring requirements in R.61-58.16.E(1) and the repeat monitoring requirements in R.61-58.17.I. If the repeat sample collected from the ground water source is E. coli-positive, the system must comply with R.61-58.16.E(1)(c).

(c) Additional Requirements. If the Department does not require corrective action under R.61-58.16.F(1)(b) for a fecal indicator positive source water sample collected under R.61-58.16.E(1)(b) that is not invalidated under R.61-58.16.E(4), the system must collect five additional source water samples from the same source within 24 hours of being notified of the fecal indicator positive sample.

(d) Consecutive and wholesale systems.

(i) In addition to the other requirements of R.61-58.16.E(1), a consecutive ground water system that has a total coliform-positive sample collected under R.61-58.5.G(1) until March 31, 2016, or under R.61-58.17.E through R.61-58.17.H beginning April 1, 2016 must notify the wholesale system(s) within 24 hours of being notified of the total coliform-positive sample.

(ii) In addition to the other requirements of R.61-58.16.E(1), a wholesale ground water system must comply with R.61-58.16.E(1)(d)(ii)(A) and R.61-58.16.E(1)(d)(ii)(B).

(A) A wholesale ground water system that receives notice from a consecutive system it serves that a sample collected under R.61-58.5.G(1) until March 31, 2016, or collected under R.61-58.17.E through R.61-58.17.H beginning April 1, 2016, is total coliform-positive must, within 24 hours of being notified, collect a sample from its ground water source(s) under R.61-58.16.E(1)(b) and analyze it for a fecal indicator under R.61-58.16.E(3).

(B) If the sample collected under R.61-58.16.E(1)(d)(ii)(A) is fecal indicator positive, the wholesale ground water system must notify all consecutive systems served by that ground water source of the fecal indicator positive sample within 24 hours of being notified of the ground water source sample_monitoring result and must meet the requirements of R.61-58.16.E(1)(c).

(e) Exceptions to the triggered source water monitoring requirements. A ground water system is not required to comply with the source water monitoring requirements of R.61-58.16.E(1) if either one of the following conditions exists:

(i) The Department determines, and documents in writing, that the total coliform-positive sample collected under R.61-58.5(G)(1) until March 31, 2016, or under R.61-58.17.E through R.61-58.17.H beginning April 1, 2016, is caused by a distribution system deficiency; or

(ii) The total coliform-positive sample collected under R.61-58.5(G)(1) until March 31, 2016, or under R.61-58.17.E through R.61-58.17.H beginning April 1, 2016, is collected at a location that meets Department criteria for distribution system conditions that will cause total coliform-positive samples.

(2) Assessment source water monitoring. If directed by the Department, ground water systems must conduct assessment source water monitoring that meets Department-determined requirements for such monitoring. A ground water system conducting assessment source water monitoring may use a triggered source water sample collected under R.61-58.16.E(1)(b) to meet the requirements of R.61-58.16.E(2). Department-determined assessment source water monitoring may include, but not be limited to the following:

(a) Collection of a total of 12 ground water source samples that represent each month the system provides ground water to the public.

(b) Collection of samples from each well unless the system obtains written Department approval to conduct monitoring at one or more wells within the ground water system that are representative of multiple wells used by that system and that draw water from the same hydrogeologic setting.

(c) Collection of a standard sample volume of at least 100 mL for fecal indicator analysis regardless of the fecal indicator or analytical method used.

(d) Analysis of all ground water source samples using one of the analytical methods listed in R.61-58.16.E(3) for the presence of E. coli, enterococci, or coliphage.

(e) Collection of ground water source samples at a location prior to any treatment of the ground water source unless the Department approves a sampling location after treatment.

(f) Collection of ground water source samples at the well itself unless the system's configuration does not allow for sampling at the well itself and the Department approves an alternate sampling location that is representative of the water quality of that well.

(3) Analytical methods.

(a) A ground water system subject to the source water monitoring requirements of R.61-58.16.E(1) must collect a standard sample volume of at least 100 ml for fecal indicator analysis regardless of the fecal indicator or analytical method used.

(b) A ground water system must analyze all ground water source samples collected under R.61-58.16.E(1) for E.coli, enterococci, or coliphage using EPA-approved methods listed in 40 CFR 141.402(c)(2) (Federal Register 11-8-2006 edition).

(4) Invalidation of a fecal indicator positive ground water source sample.

(a) A ground water system may obtain Department invalidation of a fecal indicator positive ground water source sample collected under R.61-58.16.E(1) only under the conditions specified as follows:

(i) The system provides the Department with written notice from the laboratory that improper sample analysis occurred.

(ii) The Department determines and documents in writing that there is substantial evidence that a fecal indicator positive ground water source sample is not related to source water quality.

(b) If the Department invalidates a fecal indicator positive ground water source sample, the ground water system must collect another source water sample under R.61-58.16.E(1) within 24 hours of being notified by the Department of its invalidation decision and have it analyzed for the same fecal indicator using the analytical methods listed in 40 CFR 141.402(c)(2) (Federal Register 11-8-2006 edition). The Department may extend the 24-hour time limit on a case-by-case basis if the system cannot collect the source water sample within 24 hours due to circumstances beyond its control. In the case of an extension, the Department will specify how much time the system has to collect the sample.

(5) Sampling location.

(a) Any ground water source sample required under R.61-58.16.E(1) must be collected at a location prior to any treatment of the groundwater source unless the Department approves a sampling location after treatment.

(b) If the system's configuration does not allow for sampling at the well itself, the system may collect a sample at a Department-approved location to meet the requirements under R.61-58.16.E(1) if the sample is representative of the water quality of that well.

(6) New sources. If directed by the Department, a ground water system that places a new ground water source into service after November 30, 2009, must conduct assessment source water monitoring under R.61-58.16.E(2). If directed by the Department, the system must begin monitoring before the ground water source is used to provide water to the public.

(7) Public notification. A ground water system with a ground water source sample collected under R.61-58.16.E(1) or (2) that is fecal indicator positive and that is not invalidated under R.61-58.16.E(4), including consecutive systems served by the ground water source, must conduct public notification under R.61-58.6.E(2).

(8) Monitoring violations. Failure to meet the requirements of R.61-58.16.E(1) through (6) is a monitoring violation and requires the ground water system to provide public notification under R.61-58.6.E(4).

F. Treatment Technique Requirements For Ground Water Systems.

(1) Ground water systems with significant deficiencies or source water fecal contamination.

(a) The treatment technique requirements of R.61-58.16.F must be met by ground water systems when a significant deficiency is identified or when a ground water source sample collected under R.61-58.16.E(1)(c) is fecal indicator positive.

(b) If directed by the Department, a ground water system with a ground water source sample collected under R.61-58.16.E(1)(b), R.61-58.16.E(1)(d), or R.61-58.16.E(2) that is fecal indicator positive must comply with the treatment technique requirements of R.61-58.16.F.

(c) When a significant deficiency is identified at a Subpart H public water system that uses both ground water and surface water or GWUDI, the system must comply with R.61–58.16.F except in cases where the Department determines that the significant deficiency is in a portion of the distribution system that is served solely by surface water or GWUDI.

(d) Unless the Department directs the ground water system to implement a specific corrective action, the ground water system must consult with the Department regarding the appropriate corrective action within 30 days of receiving written notice from the Department of a significant deficiency, written notice from a laboratory that a ground water source sample collected under R.61–58.16.E(1)(c) was found to be fecal indicator positive, or direction from the Department that a fecal indicator positive sample collected under R.61–58.16.E(1)(b), R.61–58.16.E(1)(d), or R.61–58.16.E(2) requires corrective action. For the purposes of R.61–58.16, significant deficiencies include, but are not limited to, defects in design, operation, or maintenance, or a failure or malfunction of the sources, treatment, storage, or distribution system that the Department determines to be causing, or have the potential for causing, the introduction of contamination into the water delivered to consumers.

(e) Within 120 days, or earlier if directed by the Department, of receiving written notification from the Department of a significant deficiency, written notice from a laboratory that a ground water source sample collected under R.61–58.16.E(1)(c) was found to be fecal indicator positive, or direction from the Department that a fecal indicator positive sample collected under R.61–58.16.E(1)(b), R.61–58.16.E(1)(d), or R.61–58.16.E(2) requires corrective action, the ground water system must either:

(i) Have completed corrective action in accordance with applicable Department plan review processes or other Department guidance or direction, if any, including Department-specified interim measures; or

(ii) Be in compliance with a Department-approved corrective action plan and schedule subject to the following conditions:

(A) Any subsequent modifications to a Department-approved corrective action plan and schedule must also be approved by the Department.

(B) If the Department specifies interim measures for the protection of public health pending Department approval of the corrective action plan and schedule or pending completion of the corrective action plan, the system must comply with these interim measures as well as with any schedule specified by the Department.

(f) Corrective action alternatives. Ground water systems that meet the conditions of R.61–58.16.F(1)(a) or (b) must implement one or more of the following corrective action alternatives:

(i) Correct all significant deficiencies.

(ii) Provide an alternate source of water.

(iii) Eliminate the source of contamination.

(iv) Provide treatment that reliably achieves at least 4-log treatment of viruses (using inactivation, removal, or a Department-approved combination of 4-log virus inactivation and removal) before or at the first customer for the ground water source.

(g) Special notice to the public of significant deficiencies or source water fecal contamination.

(i) In addition to the applicable public notification requirements of R.61–58.6.E(2), a community ground water system that receives notice from the Department of a significant deficiency or notification of a fecal indicator positive ground water source sample that is not invalidated by the Department must inform the public served by the water system under R.61–58.12.C(11)(f) of the fecal indicator positive source sample or of any significant deficiency that has not been corrected. The system must continue to inform the public annually until the significant deficiency is corrected or the fecal contamination in the ground water source is determined by the Department to be corrected under R.61–58.16.F(1)(e).

(ii) In addition to the applicable public notification requirements of R.61–58.6.E(2), a non-community ground water system that receives notice from the Department of a significant deficiency must inform the public served by the water system in a manner approved by the Department of any significant deficiency that has not been corrected within 12 months of being

notified by the Department, or earlier if directed by the Department. The system must continue to inform the public annually until the significant deficiency is corrected. The information must include:

(A) The nature of the significant deficiency and the date the significant deficiency was identified by the Department.

(B) The Department-approved plan and schedule for correction of the significant deficiency, including interim measures, progress to date, and any interim measures completed.

(C) For systems with a large proportion of non-English speaking consumers, as determined by the Department, information in the appropriate language(s) regarding the importance of the notice or a telephone number or address where consumers may contact the system to obtain a translated copy of the notice or assistance in the appropriate language.

(iii) If directed by the Department, a non-community water system with significant deficiencies that have been corrected must inform its customers of the significant deficiencies, how the deficiencies were corrected, and the dates of correction under R.61-58.16.F(1)(g)(ii).

(2) Compliance monitoring.

(a) Existing ground water sources. A ground water system that is not required to meet the source water monitoring requirements of R.61-58.16 because it provides at least 4-log treatment of viruses (using inactivation, removal, or a Department-approved combination of 4-log virus inactivation and removal) before or at the first customer for any ground water source before December 1, 2009, must notify the Department in writing that it provides at least 4-log treatment of viruses (using inactivation, removal, or a Department-approved combination of 4-log virus inactivation and removal) before or at the first customer for the specified ground water source and begin compliance monitoring in accordance with R.61-58.16.F(2)(c) by December 1, 2009. Notification to the Department must include engineering, operational, or other information that the Department requests to evaluate the submission. If the system subsequently discontinues 4-log treatment of viruses (using inactivation, removal, or a Department-approved combination of 4-log virus inactivation and removal) before or at the first customer for a ground water source, the system must conduct ground water source monitoring as required under R.61-58.16.E.

(b) New ground water sources. A ground water system that places a ground water source in service after November 30, 2009, that is not required to meet the source water monitoring requirements of R.61-58.16 because the system provides at least 4-log treatment of viruses (using inactivation, removal, or a Department-approved combination of 4-log virus inactivation and removal) before or at the first customer for the ground water source must comply with all of the requirements of R.61-58.16.F(2)(b)(i) to (iii).

(i) The system must notify the Department in writing that it provides at least 4-log treatment of viruses (using inactivation, removal, or a Department-approved combination of 4-log virus inactivation and removal) before or at the first customer for the ground water source. Notification to the Department must include engineering, operational, or other information that the Department requests to evaluate the submission.

(ii) The system must conduct compliance monitoring under R.61-58.16.F(2)(c) within 30 days of placing the source in service.

(iii) The system must conduct ground water source monitoring under R.61-58.16.E if the system subsequently discontinues 4-log treatment of viruses (using inactivation, removal, or a Department-approved combination of 4-log virus inactivation and removal) before or at the first customer for the ground water source.

(c) Monitoring requirements. A ground water system subject to the requirements of R.61-58.16.F(1), R.61-58.16.F(2)(a), or R.61-58.16.F(2)(b) must monitor the effectiveness and reliability of treatment for that ground water source before or at the first customer as follows:

(i) Chemical disinfection.

(A) A ground water system that serves greater than 3,300 people must continuously monitor the residual disinfectant concentration using analytical methods specified in 40 CFR 141.74(a)(2) at a location approved by the Department and must record the lowest residual disinfectant concentration each day that the water from the ground water source is served to the public.

The ground water system must maintain the Department-determined residual disinfectant concentration every day the ground water system serves the water from the ground water source to the public. If there is a failure in the continuous monitoring equipment, the ground water system must conduct grab sampling every four hours until the continuous monitoring equipment is returned to service. The system must resume continuous residual disinfectant monitoring within 14 days.

(B) A ground water system that serves 3,300 or fewer people must monitor the residual disinfectant concentration using analytical methods specified in 40 CFR 141.74(a)(2) at a location approved by the Department and record the residual disinfection concentration each day that the water from the ground water source is served to the public. The ground water system must maintain the Department-determined residual disinfectant concentration every day the ground water system serves water from the ground water source to the public. The ground water system must take a daily grab sample during the hour of peak flow or at another time specified by the Department. If any daily grab sample measurement falls below the Department-determined residual disinfectant concentration, the ground water system must take follow up samples every four hours until the residual disinfectant concentration is restored to the Department-determined level. Alternatively, a ground water system that serves 3,300 or fewer people may monitor continuously and meet the requirements of R.61-58.16.F.(2)(c)(i)(A).

(ii) Membrane filtration. A ground water system that uses membrane filtration to meet the requirements of R.61-58.16 must monitor the membrane filtration process in accordance with all Department-specified monitoring requirements and must operate the membrane filtration in accordance with all Department-specified compliance requirements. A ground water system that uses membrane filtration is in compliance with the requirement to achieve at least 4-log removal of viruses when the following conditions are met:

(A) The membrane has an absolute molecular weight cut-off or an alternate parameter that describes the exclusion characteristics of the membrane that can reliably achieve at least 4-log removal of viruses.

(B) The membrane process is operated in accordance with Department-specified compliance requirements.

(C) The integrity of the membrane is intact.

(iii) Alternative treatment. A ground water system that uses a Department-approved alternative treatment to meet the requirements of R.61-58.16 by providing at least 4-log treatment of viruses (using inactivation, removal, or a Department-approved combination of 4-log virus inactivation and removal) before or at the first customer must:

(A) Monitor the alternative treatment in accordance with all Department-specified monitoring requirements.

(B) Operate the alternative treatment in accordance with all compliance requirements that the Department determines to be necessary to achieve at least 4-log treatment of viruses.

(3) A ground water system may discontinue 4-log treatment of viruses (using inactivation, removal, or a Department-approved combination of 4-log virus inactivation and removal) before or at the first customer for a ground water source if the Department determines and documents in writing that 4-log treatment of viruses is no longer necessary for that ground water source. A system that discontinues 4-log treatment of viruses is subject to the source water monitoring and analytical methods requirements of R.61-58.16.E.

(4) Failure to meet the monitoring requirements of R.61-58.16.F(2) is a monitoring violation and requires the ground water system to provide public notification under R.61-58.6.E(4).

G. Treatment Technique Violations For Ground Water Systems.

(1) A ground water system with a significant deficiency is in violation of the treatment technique requirement if, within 120 days (or earlier if directed by the Department) of receiving written notice from the Department of the significant deficiency, the system:

(a) Does not complete corrective action in accordance with any applicable Department plan review processes or other Department guidance and direction, including Department specified interim actions and measures; or

(b) Is not in compliance with a Department-approved corrective action plan and schedule.

(2) Unless the Department invalidates a fecal indicator positive ground water source sample under R.61-58.16.E(4), a ground water system is in violation of the treatment technique requirement if, within 120 days (or earlier if directed by the Department) of meeting the conditions of R.61-58.16.F(1)(a) or R.61-58.16.F(1)(b), the system:

(a) Does not complete corrective action in accordance with any applicable Department plan review processes or other Department guidance and direction, including Department-specified interim measures; or

(b) Is not in compliance with a Department-approved corrective action plan and schedule.

(3) A ground water system subject to the requirements of R.61-58.16.F(2)(c) that fails to maintain at least 4-log treatment of viruses (using inactivation, removal, or a Department-approved combination of 4-log virus inactivation and removal) before or at the first customer for a ground water source is in violation of the treatment technique requirement if the failure is not corrected within four hours of determining the system is not maintaining at least 4-log treatment of viruses before or at the first customer.

(4) Ground water systems must give public notification under R.61-58.6.E(3) for the treatment technique violations specified in R.61-58.16.G(1), G(2), and G(3).

H. Reporting and Recordkeeping For Ground Water Systems.

(1) Reporting. In addition to the requirements of R.61-58.6.B, a ground water system regulated under R.61-58.16 must provide the following information to the Department:

(a) A ground water system conducting compliance monitoring under R.61-58.16.F(2) must notify the Department any time the system fails to meet any Department-specified requirements including, but not limited to, minimum residual disinfectant concentration, membrane operating criteria or membrane integrity, and alternative treatment operating criteria, if operation in accordance with the criteria or requirements is not restored within four hours. The ground water system must notify the Department as soon as possible, but in no case later than the end of the next business day.

(b) After completing any corrective action under R.61-58.16.F(1), a ground water system must notify the Department within 30 days of completion of the corrective action.

(c) If a ground water system subject to the requirements of R.61-58.16.E(1) does not conduct source water monitoring under R.61-58.16.E(1)(e)(ii), the system must provide documentation to the Department within 30 days of the total coliform positive sample that it met the Department criteria.

(2) Recordkeeping. In addition to the requirements of R.61-58.6.D, a ground water system regulated under R.61-58.16 must maintain the following information in its records:

(a) Documentation of corrective actions shall be kept for a period of not less than ten years.

(b) Documentation of notice to the public as required under R.61-58.16.F(1)(g) shall be kept for a period of not less than three years.

(c) Records of decisions under R.61-58.16.E(1)(e)(ii) and records of invalidation of fecal indicator positive ground water source samples under R.61-58.16.E(4) shall be kept for a period of not less than five years.

(d) For consecutive systems, documentation of notification to the wholesale system(s) of total coliform-positive samples that are not invalidated under R.61-58.5.G(3) until April 1, 2016, or under R.61-58.17.D beginning April 1, 2016, shall be kept for a period of not less than five years.

(e) For systems, including wholesale systems, that are required to perform compliance monitoring under R.61-58.16.F(2):

(i) Records of the Department-specified minimum disinfectant residual shall be kept for a period of not less than ten years.

(ii) Records of the lowest daily residual disinfectant concentration and records of the date and duration of any failure to maintain the Department-specified minimum residual disinfectant concentration for a period of more than four hours shall be kept for a period of not less than five years.

(iii) Records of Department-specified compliance requirements for membrane filtration and of parameters specified by the Department for Department-approved alternative treatment and

records of the date and duration of any failure to meet the membrane operating, membrane integrity, or alternative treatment operating requirements for more than four hours shall be kept for a period of not less than five years.

HISTORY: Added by State Register Volume 32, Issue No. 4, eff April 25, 2008; Amended by State Register Volume 38, Issue No. 9, Doc. No. 4469, eff September 26, 2014; SCSR 46-12 Doc. No. 5135, eff December 23, 2022.

61-58.17. Revised Total Coliform Rule.

A. Applicability. The provisions of R.61-58.17 apply to all community and non-community public water systems.

B. General Requirements.

(1) General.

The provisions of R.61-58.17 include both maximum contaminant level and treatment technique requirements.

(2) Compliance date.

Systems must comply with the provisions of R.61-58.17 beginning April 1, 2016, unless otherwise specified in R.61-58.17.

(3) Violations of State Primary Drinking Water Regulations. Failure to comply with the applicable requirements of this regulation R.61-58.17 shall constitute a violation of the State Primary Drinking Water Regulations.

C. Analytical Methods and Laboratory Certification

(1) Analytical methodology.

(a) The standard sample volume required for analysis, regardless of analytical method used, is 100 ml.

(b) Systems need only determine the presence or absence of total coliforms and E. coli; a determination of density is not required.

(c) The time from sample collection to initiation of test medium incubation may not exceed 30 hours. Systems are encouraged but not required to hold samples below 10 deg. C during transit.

(d) If water having residual chlorine (measured as free, combined, or total chlorine) is to be analyzed, sufficient sodium thiosulfate (Na₂S₂O₃) must be added to the sample bottle before sterilization to neutralize any residual chlorine in the water sample. Dechlorination procedures are addressed in Section 9060A.2 of Standard Methods for the Examination of Water and Wastewater (20th and 21st editions).

(e) Systems must conduct total coliform and E. coli analyses in accordance with one of the analytical methods in 40 CFR 141.852 or one of the alternative methods listed in Appendix A to subpart C of CFR 141.

(2) Laboratory Certification.

Systems must have all compliance samples required under R.61-58.17 analyzed by a laboratory certified by the EPA or the Department to analyze drinking water samples. The laboratory used by the system must be certified for each method (and associated contaminant(s)) used for compliance monitoring analyses under this rule.

D. General Monitoring Requirements for All Public Water Systems.

(1) Sample siting plans.

(a) Systems must develop a written sample siting plan that identifies sampling sites and a sample collection schedule that are representative of water throughout the distribution system not later than March 31, 2016. These plans are subject to Department review and revision. Systems must collect total coliform samples according to the written sample siting plan. Monitoring required by R.61-58.17.E through R.61-58.17.I may take place at a customer's premise, dedicated sampling station, or other designated compliance sampling location. Routine and repeat sample sites and any sampling points necessary to meet the requirements of R.61-58.16 must be reflected in the sampling plan.

(b) Systems must collect samples at regular time intervals throughout the month, except that systems that use only ground water and serve 4,900 or fewer people may collect all required samples on a single day if they are taken from different sites.

(c) Systems must take at least the minimum number of required samples even if the system has had an E. coli MCL violation or has exceeded the coliform treatment technique triggers in R.61-58.17.J(1).

(d) A system may conduct more compliance monitoring than is required by R.61-58.17 to investigate potential problems in the distribution system and use monitoring as a tool to assist in uncovering problems. A system may take more than the minimum number of required routine samples and must include the results in calculating whether the coliform treatment technique trigger in R.61-58.17.J(1)(a)(i) and (ii) has been exceeded only if the samples are taken in accordance with the existing sample siting plan and are representative of water throughout the distribution system.

(e) Systems must identify repeat monitoring locations in the sample siting plan. Unless the provisions of R.61-58.17.D(1)(e)(i) or (1)(e)(ii) are met, the system must collect at least one repeat sample from the sampling tap where the original total coliform-positive sample was taken, and at least one repeat sample at a tap within five service connections upstream and at least one repeat sample at a tap within five service connections downstream of the original sampling site. If a total coliform-positive sample is at the end of the distribution system, or one service connection away from the end of the distribution system, the system must still take all required repeat samples. However, the Department may allow an alternative sampling location in lieu of the requirement to collect at least one repeat sample upstream or downstream of the original sampling site. Except as provided for in R.61-58.17.D(1)(e)(ii), systems required to conduct triggered source water monitoring under R.61-58.16.E(1) must take ground water source sample(s) in addition to repeat samples required under R.61-58.17.

(i) Systems may propose repeat monitoring locations to the Department that the system believes to be representative of a pathway for contamination of the distribution system. A system may elect to specify either alternative fixed locations or criteria for selecting repeat sampling sites on a situational basis in a standard operating procedure (SOP) in its sample siting plan. The system must design its SOP to focus the repeat samples at locations that best verify and determine the extent of potential contamination of the distribution system area based on specific situations. The Department may modify the SOP or require alternative monitoring locations as needed.

(ii) Ground water systems serving 1,000 or fewer people may propose repeat sampling locations to the Department that differentiate potential source water and distribution system contamination (e.g., by sampling at entry points to the distribution system). A ground water system with a single well required to conduct triggered source water monitoring may, with written Department approval, take one of its repeat samples at the monitoring location required for triggered source water monitoring under R.61-58.16.E(1) if the system demonstrates to the Department's satisfaction that the sample siting plan remains representative of water quality in the distribution system. If approved by the Department, the system may use that sample result to meet the monitoring requirements in both R.61-58.16.E(1) and this section R.61-58.17.D.

(A) If a repeat sample taken at the monitoring location required for triggered source water monitoring is E. coli-positive, the system has violated the E. coli MCL and must also comply with R.61-58.16.E(1)(c). If a system takes more than one repeat sample at the monitoring location required for triggered source water monitoring, the system may reduce the number of additional source water samples required under R.61-58.16.E(1)(c) by the number of repeat samples taken at that location that were not E. coli-positive.

(B) If a system takes more than one repeat sample at the monitoring location required for triggered source water monitoring under R.61-58.16.E(1), and more than one repeat sample is E. coli-positive, the system has violated the E. coli MCL and must also comply with R.61-58.16.F(1)(a).

(C) If all repeat samples taken at the monitoring location required for triggered source water monitoring are E. coli-negative and a repeat sample taken at a monitoring location other than the one required for triggered source water monitoring is E. coli-positive, the system has violated the E. coli MCL, but is not required to comply with R.61-58.16.E(1)(c).

(f) The Department may review, revise, and approve, as appropriate, repeat sampling proposed by systems under R.61-58.17.D(1)(e)(i) and (ii). The system must demonstrate that the sample siting plan remains representative of the water quality in the distribution system. The Department may determine that monitoring at the entry point to the distribution system (especially for undisinfecting ground water systems) is effective to differentiate between potential source water and distribution system problems.

(2) Special purpose samples.

Special purpose samples, such as those taken to determine whether disinfection practices are sufficient following pipe placement, replacement, or repair, must not be used to determine whether the coliform treatment technique trigger has been exceeded. Repeat samples taken pursuant to R.61-58.17.I are not considered special purpose samples, and must be used to determine whether the coliform treatment technique trigger has been exceeded.

(3) Invalidation of total coliform samples.

A total coliform-positive sample invalidated under R.61-58.17.D(3) does not count toward meeting the minimum monitoring requirements of this R.61-58.17.

(a) The Department may invalidate a total coliform-positive sample only if the conditions of R.61-58.17.D(3)(a)(i), (ii), or (iii) are met.

(i) The laboratory establishes that improper sample analysis caused the total coliform-positive result.

(ii) The Department, on the basis of the results of repeat samples collected as required under R.61-58.17.I(1), determines that the total coliform-positive sample resulted from a domestic or other non-distribution system plumbing problem. The Department cannot invalidate a sample on the basis of repeat sample results unless all repeat sample(s) collected at the same tap as the original total coliform-positive sample are also total coliform-positive, and all repeat samples collected at a location other than the original tap are total coliform negative (e.g., the Department cannot invalidate a total coliform-positive sample on the basis of repeat samples if all the repeat samples are total coliform negative, or if the system has only one service connection).

(iii) The Department has substantial grounds to believe that a total coliform-positive result is due to a circumstance or condition that does not reflect water quality in the distribution system. In this case, the system must still collect all repeat samples required under R.61-58.17.I(1), and use them to determine whether a coliform treatment technique trigger in R.61-58.17.J has been exceeded. To invalidate a total coliform-positive sample under this paragraph, the decision and supporting rationale must be documented in writing, and approved and signed by the supervisor of the Department official who recommended the decision. The Department must make this document available to EPA and the public. The written documentation must state the specific cause of the total coliform-positive sample, and what action the system has taken, or will take, to correct this problem. The Department may not invalidate a total coliform-positive sample solely on the grounds that all repeat samples are total coliform negative.

(b) A laboratory must invalidate a total coliform sample (unless total coliforms are detected) if the sample produces a turbid culture in the absence of gas production using an analytical method where gas formation is examined (e.g., the Multiple-Tube Fermentation Technique), produces a turbid culture in the absence of an acid reaction in the Presence-Absence (P-A) Coliform Test, or exhibits confluent growth or produces colonies too numerous to count with an analytical method using a membrane filter (e.g., Membrane Filter Technique). If a laboratory invalidates a sample because of such interference, the system must collect another sample from the same location as the original sample within 24 hours of being notified of the interference problem, and have it analyzed for the presence of total coliforms. The system must continue to re-sample within 24 hours and have the samples analyzed until it obtains a valid result. The Department may waive the 24-hour time limit on a case-by-case basis. Alternatively, the Department may implement criteria for waiving the 24-hour sampling time limit to use in lieu of case-by-case extensions.

E. Routine monitoring requirements for non-community water systems serving 1,000 or fewer people using only ground water.

(1) General.

(a) The provisions of this section apply to non-community water systems using only ground water (except ground water under the direct influence of surface water, as defined in R.61-58.B - Definitions) and serving 1,000 or fewer people.

(b) Following any total coliform-positive sample taken under the provisions of this section, systems must comply with the repeat monitoring requirements and E. coli analytical requirements in R.61-58.17.I.

(c) Once all monitoring required by this section R.61-58.17.E and R.61-58.17.I for a calendar month has been completed, systems must determine whether any coliform treatment technique triggers specified in R.61-58.17.J have been exceeded. If any trigger has been exceeded, systems must complete assessments as required by R.61-58.17.J.

(d) For the purpose of determining eligibility for remaining on or qualifying for quarterly monitoring under the provisions of R.61-58.17.E(6)(d) and (7)(b), respectively, of this section R.61-58.17.E for transient non-community water systems, the Department may elect to not count monitoring violations under R.61-58.17.K(3)(a) if the missed sample is collected no later than the end of the monitoring period following the monitoring period in which the sample was missed. The system must collect the make-up sample in a different week than the routine sample for that monitoring period and should collect the sample as soon as possible during the monitoring period. The Department may not use this provision under R.61-58.17.E(8). This authority does not affect the provisions of R.61-58.17.K(3)(a) and R.61-58.17.L(1)(d).

(2) Monitoring frequency for total coliforms.

Systems must monitor each calendar quarter that the system provides water to the public, except for seasonal systems or as provided under R.61-58.17.E(3) through R.61-58.17.E(8) and R.61-58.17.E(10). Seasonal systems must meet the monitoring requirements of R.61-58.17.E(9).

(3) Transition to R.61-58.17 - Revised Total Coliform Rule.

(a) Systems, including seasonal systems, must continue to monitor according to the total coliform monitoring schedules under R.61-58.5.G(1) that were in effect on March 31, 2016, unless any of the conditions for increased monitoring in R.61-58.17.E(6) are triggered on or after April 1, 2016, or unless otherwise directed by the Department.

(b) Beginning April 1, 2016, the Department must perform a special monitoring evaluation during each sanitary survey to review the status of the system, including the distribution system, to determine whether the system is on an appropriate monitoring schedule. After the Department has performed the special monitoring evaluation during each sanitary survey, the Department may modify the system's monitoring schedule, as necessary, or it may allow the system to stay on its existing monitoring schedule, consistent with the provisions of R.61-58.17.E. The Department may not allow systems to begin less frequent monitoring under the special monitoring evaluation unless the system has already met the applicable criteria for less frequent monitoring in R.61-58.17.E. For seasonal systems on quarterly or annual monitoring, this evaluation must include review of the approved sample siting plan, which must designate the time period(s) for monitoring based on site-specific considerations (e.g., during periods of highest demand or highest vulnerability to contamination). The seasonal system must collect compliance samples during these time periods.

(4) Annual site visits.

Beginning no later than calendar year 2017, systems on annual monitoring, including seasonal systems, must have an initial and recurring annual site visit by the Department that is equivalent to a Level 2 assessment or an annual voluntary Level 2 assessment that meets the criteria in R.61-58.17.J(2) to remain on annual monitoring. The periodic required sanitary survey may be used to meet the requirement for an annual site visit for the year in which the sanitary survey was completed.

(5) Criteria for annual monitoring. Beginning April 1, 2016, the Department may reduce the monitoring frequency for a well-operated ground water system from quarterly routine monitoring to no less than annual monitoring, if the system demonstrates that it meets the criteria for reduced monitoring in R.61-58.17.E(5)(a) through (5)(c), except for a system that has been on increased monitoring under the provisions of R.61-58.17.E(6). A system on increased monitoring under R.61-58.17.E(6) must meet the provisions of R.61-58.17.E(7) to go to quarterly monitoring and must meet the provisions of R.61-58.17.E(8) to go to annual monitoring.

(a) The system has a clean compliance history for a minimum of 12 months;

(b) The most recent sanitary survey shows that the system is free of sanitary defects or has corrected all identified sanitary defects, has a protected water source, and meets approved construction standards; and

(c) The Department has conducted an annual site visit within the last 12 months and the system has corrected all identified sanitary defects. The system may substitute a Level 2 assessment that meets the criteria in R.61-58.17.J(2) for the Department annual site visit.

(6) Increased Monitoring Requirements for systems on quarterly or annual monitoring.

A system on quarterly or annual monitoring that experiences any of the events identified in R.61-58.17.E(6)(a) through (6)(d) must begin monthly monitoring the month following the event. A system on annual monitoring that experiences the event identified in R.61-58.17.E(6)(e) must begin quarterly monitoring the quarter following the event. The system must continue monthly or quarterly monitoring until the requirements in R.61-58.17.E(7) for quarterly monitoring or R.61-58.17.E(8) for annual monitoring are met. A system on monthly monitoring for reasons other than those identified in R.61-58.17.E(6)(a) through (6)(d) is not considered to be on increased monitoring for the purposes of R.61-58.17.E(7) and (8).

(a) The system triggers a Level 2 assessment or two Level 1 assessments under the provisions of R.61-58.17.J in a rolling 12-month period.

(b) The system has an E. coli MCL violation.

(c) The system has a coliform treatment technique violation.

(d) The system has two monitoring violations under R.61-58.17 or one monitoring violation under R.61-58.17 and one Level 1 assessment under the provisions of R.61-58.17.J in a rolling 12-month period for a system on quarterly monitoring.

(e) The system has one monitoring violation under R.61-58.17 for a system on annual monitoring.

(7) Requirements for returning to quarterly monitoring.

The Department may reduce the monitoring frequency for a system on monthly monitoring triggered under R.61-58.17.E(6) to quarterly monitoring if the system meets the criteria in R.61-58.17.E(7)(a) and (7)(b).

(a) Within the last 12 months, the system must have a completed sanitary survey or a site visit by the Department or a voluntary Level 2 assessment by a party approved by the Department, be free of sanitary defects, and have a protected water source; and

(b) The system must have a clean compliance history for a minimum of 12 months.

(8) Requirements for systems on increased monitoring to qualify for annual monitoring.

The Department may reduce the monitoring frequency for a system on increased monitoring under R.61-58.17.E(6) if the system meets the criteria in R.61-58.17.E(7) plus the criteria in R.61-58.17.E(8)(a) and (8)(b).

(a) An annual site visit by the Department and correction of all identified sanitary defects. The system may substitute a voluntary Level 2 assessment by a party approved by the Department for the Department annual site visit in any given year.

(b) The system must have in place or adopt one or more additional enhancements to the water system barriers to contamination in R.61-58.17.E(8)(b)(i) through (8)(b)(v).

(i) Cross connection control, as approved by the Department.

(ii) An operator certified by the South Carolina Department of Labor, Licensing and Regulation - Environmental Certification Board or regular visits by a circuit rider certified by an appropriate State certification program.

(iii) Continuous disinfection entering the distribution system and a residual in the distribution system in accordance with criteria specified by the Department.

(iv) Demonstration of maintenance of at least a 4-log removal or inactivation of viruses as provided for under R.61-58.16.F(2)(c).

(v) Other equivalent enhancements to water system barriers as approved by the Department.

(9) Seasonal systems.

(a) Beginning April 1, 2016, all seasonal systems must demonstrate completion of a Department-approved start-up procedure, which may include a requirement for startup sampling prior to serving water to the public.

(b) A seasonal system must monitor every month that it is in operation unless it meets the criteria in R.61-58.17.E(9)(b)(i) through (iii) to be eligible for monitoring less frequently than monthly beginning April 1, 2016, except as provided under R.61-58.17.E(3).

(i) Seasonal systems monitoring less frequently than monthly must have an approved sample siting plan that designates the time period for monitoring based on site-specific considerations (e.g., during periods of highest demand or highest vulnerability to contamination). Seasonal systems must collect compliance samples during this time period.

(ii) To be eligible for quarterly monitoring, the system must meet the criteria in R.61-58.17.E(7).

(iii) To be eligible for annual monitoring, the system must meet the criteria under R.61-58.17.E(8).

(c) The Department may exempt any seasonal system from some or all of the requirements for seasonal systems if the entire distribution system remains pressurized during the entire period that the system is not operating, except that systems that monitor less frequently than monthly must still monitor during the vulnerable period designated by the Department.

(10) Additional routine monitoring the month following a total coliform-positive sample.

Systems collecting samples on a quarterly or annual frequency must conduct additional routine monitoring the month following one or more total coliform-positive samples (with or without a Level 1 treatment technique trigger). Systems must collect at least three routine samples during the next month, except that the Department may waive this requirement if the conditions of R.61-58.17.E(10)(a), (b), or (c) are met. Systems may either collect samples at regular time intervals throughout the month or may collect all required routine samples on a single day if samples are taken from different sites. Systems must use the results of additional routine samples in coliform treatment technique trigger calculations under R.61-58.17.J(1).

(a) The Department may waive the requirement to collect three routine samples the next month in which the system provides water to the public if the Department, or an agent approved by the Department, performs a site visit before the end of the next month in which the system provides water to the public. Although a sanitary survey need not be performed, the site visit must be sufficiently detailed to allow the Department to determine whether additional monitoring and/or any corrective action is needed. The Department cannot approve an employee of the system to perform this site visit, even if the employee is an agent approved by the Department to perform sanitary surveys.

(b) The Department may waive the requirement to collect three routine samples the next month in which the system provides water to the public if the Department has determined why the sample was total coliform-positive and has established that the system has corrected the problem or will correct the problem before the end of the next month in which the system serves water to the public. In this case, the Department must document this decision to waive the following month's additional monitoring requirement in writing, have it approved and signed by the supervisor of the Department official who recommends such a decision, and make this document available to the EPA and public. The written documentation must describe the specific cause of the total coliform-positive sample and what action the system has taken and/or will take to correct this problem.

(c) The Department may not waive the requirement to collect three additional routine samples the next month in which the system provides water to the public solely on the grounds that all repeat samples are total coliform negative. If the Department determines that the system has corrected the contamination problem before the system takes the set of repeat samples required in R.61-58.17.I, and all repeat samples were total coliform negative, the Department may waive the requirement for additional routine monitoring the next month.

F. Routine monitoring requirements for community water systems serving 1,000 or fewer people using only ground water.

(1) General.

(a) The provisions of this section apply to community water systems using only ground water (except ground water under the direct influence of surface water, as defined in R.61-58.B - Definitions) and serving 1,000 or fewer people.

(b) Following any total coliform-positive sample taken under the provisions of this section, systems must comply with the repeat monitoring requirements and E. coli analytical requirements in R.61-58.17.I.

(c) Once all monitoring required by this section and R.61-58.17.I for a calendar month has been completed, systems must determine whether any coliform treatment technique triggers specified in R.61-58.17.J have been exceeded. If any trigger has been exceeded, systems must complete assessments as required by R.61-58.17.J.

(2) Monitoring frequency for total coliforms.

The monitoring frequency for total coliforms is one sample per month, except as provided for under R.61-58.17.F(3) through (6).

(3) Transition to R.61-58.17 - Revised Total Coliform Rule.

(a) All systems must continue to monitor according to the total coliform monitoring schedules under R.61-58.5.G that were in effect on March 31, 2016, unless any of the conditions in R.61-58.17.F(5) are triggered on or after April 1, 2016, or unless otherwise directed by the Department.

(b) Beginning April 1, 2016, the Department must perform a special monitoring evaluation during each sanitary survey to review the status of the system, including the distribution system, to determine whether the system is on an appropriate monitoring schedule. After the Department has performed the special monitoring evaluation during each sanitary survey, the Department may modify the system's monitoring schedule, as necessary, or it may allow the system to stay on its existing monitoring schedule, consistent with the provisions of R.61-58.17.F. The Department may not allow systems to begin less frequent monitoring under the special monitoring evaluation unless the system has already met the applicable criteria for less frequent monitoring in R.61-58.17.F.

(4) Criteria for reduced monitoring.

(a) The Department may reduce the monitoring frequency from monthly monitoring to no less than quarterly monitoring if the system is in compliance with Department-certified operator provisions and demonstrates that it meets the criteria in R.61-58.17.F(4)(a)(i) through (4)(a)(iii). A system that loses its certified operator must return to monthly monitoring the month following that loss.

(i) The system has a clean compliance history for a minimum of 12 months.

(ii) The most recent sanitary survey shows the system is free of sanitary defects (or has an approved plan and schedule to correct them and is in compliance with the plan and the schedule), has a protected water source and meets approved construction standards.

(iii) The system meets at least one of the following criteria:

(A) An annual site visit by the Department that is equivalent to a Level 2 assessment or an annual Level 2 assessment by a party approved by the Department and correction of all identified sanitary defects (or an approved plan and schedule to correct them and is in compliance with the plan and schedule).

(B) Cross connection control, as approved by the Department.

(C) Continuous disinfection entering the distribution system and a residual in the distribution system in accordance with criteria specified by the Department.

(D) Demonstration of maintenance of at least a 4-log removal or inactivation of viruses as provided for under R.61-58.16.F(2)(c).

(E) Other equivalent enhancements to water system barriers as approved by the Department.

(b) Reserved

(5) Return to routine monthly monitoring requirements.

Systems on quarterly monitoring that experience any of the events in R.61-58.17.F(5)(a) through (5)(d) must begin monthly monitoring the month following the event. The system must continue monthly monitoring until it meets the reduced monitoring requirements in R.61-58.17.F(4).

- (a) The system triggers a Level 2 assessment or triggers two Level 1 assessments in a rolling 12-month period.
- (b) The system has an E. coli MCL violation.
- (c) The system has a coliform treatment technique violation.
- (d) The system has two monitoring violations under R.61-58.17 in a rolling 12-month period.
- (6) Additional routine monitoring the month following a total coliform-positive sample.

Systems collecting samples on a quarterly frequency must conduct additional routine monitoring the month following one or more total coliform-positive samples (with or without a Level 1 treatment technique trigger). Systems must collect at least three routine samples during the next month, except that the Department may waive this requirement if the conditions of R.61-58.17.F(6)(a), (b), or (c) are met. Systems may either collect samples at regular time intervals throughout the month or may collect all required routine samples on a single day if samples are taken from different sites. Systems must use the results of additional routine samples in coliform treatment technique trigger calculations.

- (a) The Department may waive the requirement to collect three routine samples the next month in which the system provides water to the public if the Department, or an agent approved by the Department, performs a site visit before the end of the next month in which the system provides water to the public. Although a sanitary survey need not be performed, the site visit must be sufficiently detailed to allow the Department to determine whether additional monitoring and/or any corrective action is needed. The Department cannot approve an employee of the system to perform this site visit, even if the employee is an agent approved by the Department to perform sanitary surveys.
- (b) The Department may waive the requirement to collect three routine samples the next month in which the system provides water to the public if the Department has determined why the sample was total coliform-positive and has established that the system has corrected the problem or will correct the problem before the end of the next month in which the system serves water to the public. In this case, the Department must document this decision to waive the following month's additional monitoring requirement in writing, have it approved and signed by the supervisor of the Department official who recommends such a decision, and make this document available to the EPA and the public. The written documentation must describe the specific cause of the total coliform-positive sample and what action the system has taken and/or will take to correct this problem.
- (c) The Department may not waive the requirement to collect three additional routine samples the next month in which the system provides water to the public solely on the grounds that all repeat samples are total coliform negative. If the Department determines that the system has corrected the contamination problem before the system takes the set of repeat samples required in R.61-58.17.I, and all repeat samples were total coliform negative, the Department may waive the requirement for additional routine monitoring the next month.

G. Routine monitoring requirements for subpart H public water systems serving 1,000 or fewer people.

(1) General.

- (a) The provisions of this section apply to subpart H public water systems serving 1,000 or fewer people.
- (b) Following any total coliform-positive sample taken under the provisions of R.61-58.17.G, systems must comply with the repeat monitoring requirements and E. coli analytical requirements in R.61-58.17.I.
- (c) Once all monitoring required by this section and R.61-58.17.I for a calendar month has been completed, systems must determine whether any coliform treatment technique triggers specified in R.61-58.17.J have been exceeded. If any trigger has been exceeded, systems must complete assessments as required by R.61-58.17.J.
- (d) Seasonal systems.

(i) Beginning April 1, 2016, all seasonal systems must demonstrate completion of a Department-approved start-up procedure, which may include a requirement for start-up sampling prior to serving water to the public.

(ii) The Department may exempt any seasonal system from some or all of the requirements for seasonal systems if the entire distribution system remains pressurized during the entire period that the system is not operating.

(2) Routine monitoring frequency for total coliforms.

Subpart H systems (including consecutive systems) must monitor monthly. Systems may not reduce monitoring.

(3) Unfiltered subpart H systems.

A subpart H system that does not practice filtration in compliance with R.61-58.10 must collect at least one total coliform sample near the first service connection each day the turbidity level of the source water, measured as specified in R.61-58.10.F(2)(b), exceeds 1 NTU. When one or more turbidity measurements in any day exceed 1 NTU, the system must collect this coliform sample within 24 hours of the first exceedance, unless the Department determines that the system, for logistical reasons outside the system's control, cannot have the sample analyzed within 30 hours of collection and identifies an alternative sample collection schedule. Sample results from this coliform monitoring must be included in determining whether the coliform treatment technique trigger in R.61-58.17.J has been exceeded.

H. Routine monitoring requirements for public water systems serving more than 1,000 people.

(1) General.

(a) The provisions of R.61-58.17.H apply to public water systems serving more than 1,000 persons.

(b) Following any total coliform-positive sample taken under the provisions of R.61-58.17.H, systems must comply with the repeat monitoring requirements and E. coli analytical requirements in R.61-58.17.I.

(c) Once all monitoring required by this section and R.61-58.17.I for a calendar month has been completed, systems must determine whether any coliform treatment technique triggers specified in R.61-58.17.J have been exceeded. If any trigger has been exceeded, systems must complete assessments as required by R.61-58.17.J.

(d) Seasonal systems.

(i) Beginning April 1, 2016, all seasonal systems must demonstrate completion of a Department-approved start-up procedure, which may include a requirement for start-up sampling prior to serving water to the public.

(ii) The Department may exempt any seasonal system from some or all of the requirements for seasonal systems if the entire distribution system remains pressurized during the entire period that the system is not operating.

(2) Monitoring frequency for total coliforms.

The monitoring frequency for total coliforms is based on the population served by the system, as follows:

MINIMUM NUMBER OF POPULATION SERVED	MINIMUM NUMBER OF SAMPLES PER MONTH
1,001 to 2,500	2
2,501 to 3,300	3
3,301 to 4,100	4
4,101 to 4,900	5
4,901 to 5,800	6
5,801 to 6,700	7
6,701 to 7,600	8
7,601 to 8,500	9

8,501 to 12,900	10
12,901 to 17,200	15
17,201 to 21,500	20
21,501 to 25,000	25
25,001 to 33,000	30
33,001 to 41,000	40
41,001 to 50,000	50
50,001 to 59,000	60
59,001 to 70,000	70
70,001 to 83,000	80
83,001 to 96,000	90
96,001 to 130,000	100
130,001 to 220,000	120
220,001 to 320,000	150
320,001 to 450,000	180
450,001 to 600,000	210
600,001 to 780,000	240
780,001 to 970,000	270
970,001 to 1,230,000	300
1,230,001 to 1,520,000	330
1,520,001 to 1,850,000	360
1,850,001 to 2,270,000	390
2,270,001 to 3,020,000	420
3,020,001 to 3,960,000	450
3,960,001 or more	480

(3) Unfiltered subpart H systems.

A subpart H system that does not practice filtration in compliance with R.61-58.10 must collect at least one total coliform sample near the first service connection each day the turbidity level of the source water, measured as specified in R.61-58.10.F(2)(b), exceeds 1 NTU. When one or more turbidity measurements in any day exceed 1 NTU, the system must collect this coliform sample within 24 hours of the first exceedance, unless the Department determines that the system, for logistical reasons outside the system's control, cannot have the sample analyzed within 30 hours of collection and identifies an alternative sample collection schedule. Sample results from this coliform monitoring must be included in determining whether the coliform treatment technique trigger in R.61-58.17.J has been exceeded.

(4) Reduced monitoring.

Systems may not reduce monitoring, except for non-community water systems using only ground water (and not ground water under the direct influence of surface water) serving 1,000 or fewer people in some months and more than 1,000 persons in other months. In months when more than 1,000 persons are served, the systems must monitor at the frequency specified in paragraph R.61-58.17.H(2). In months when 1,000 or fewer people are served, the Department may reduce the monitoring frequency, in writing, to a frequency allowed under R.61-58.17.E for a similarly situated system that always serves 1,000 or fewer people, taking into account the provisions in R.61-58.17.E(5) through (7).

I. Repeat monitoring and E. coli requirements.

(1) Repeat monitoring.

(a) If a sample taken under R.61-58.17.E though R.61-58.17.H is total coliform-positive, the system must collect a set of repeat samples within 24 hours of being notified of the positive result. The system must collect no fewer than three repeat samples for each total coliform-positive sample found. The Department may extend the 24-hour limit on a case-by-case basis if the system has a logistical problem in collecting the repeat samples within 24 hours that is beyond its control. Alternatively, the Department may implement criteria for the system to use in lieu of case-by-case

extensions. In the case of an extension, the Department must specify how much time the system has to collect the repeat samples. The Department cannot waive the requirement for a system to collect repeat samples in R.61-58.17.I(1)(a) through (1)(c).

(b) The system must collect all repeat samples on the same day, except that the Department may allow a system with a single service connection to collect the required set of repeat samples over a three-day period or to collect a larger volume repeat sample(s) in one or more sample containers of any size, as long as the total volume collected is at least 300 ml.

(c) The system must collect an additional set of repeat samples in the manner specified in R.61-58.17.I(1)(a) through (1)(c) if one or more repeat samples in the current set of repeat samples is total coliform-positive. The system must collect the additional set of repeat samples within 24 hours of being notified of the positive result, unless the Department extends the limit as provided in R.61-58.17.I(1)(a). The system must continue to collect additional sets of repeat samples until either total coliforms are not detected in one complete set of repeat samples or the system determines that a coliform treatment technique trigger specified in R.61-58.17.J(1) has been exceeded as a result of a repeat sample being total coliform-positive and notifies the Department. If a trigger identified in R.61-58.17.J is exceeded as a result of a routine sample being total coliform-positive, systems are required to conduct only one round of repeat monitoring for each total coliform-positive routine sample.

(d) After a system collects a routine sample and before it learns the results of the analysis of that sample, if it collects another routine sample(s) from within five adjacent service connections of the initial sample, and the initial sample, after analysis, is found to contain total coliforms, then the system may count the subsequent sample(s) as a repeat sample instead of as a routine sample.

(e) Results of all routine and repeat samples taken under R.61-58.17.E through R.61-58.17.I not invalidated by the Department must be used to determine whether a coliform treatment technique trigger specified in R.61-58.17.J has been exceeded.

(2) *Escherichia coli* (*E. coli*) testing.

(a) If any routine or repeat sample is total coliform-positive, the system must analyze that total coliform-positive culture medium to determine if *E. coli* are present. If *E. coli* are present, the system must notify the Department by the end of the day when the system is notified of the test result, unless the system is notified of the result after the Department office is closed and the Department does not have either an after-hours phone line or an alternative notification procedure, in which case the system must notify the Department before the end of the next business day.

(b) The Department has the discretion to allow a system, on a case-by-case basis, to forgo *E. coli* testing on a total coliform-positive sample if that system assumes that the total coliform-positive sample is *E. coli*-positive. Accordingly, the system must notify the Department as specified in R.61-58.17.I(2)(a) and the provisions of R.61-58.5.F(3) apply.

J. Coliform treatment technique triggers and assessment requirements for protection against potential fecal contamination.

(1) Treatment technique triggers.

Systems must conduct assessments in accordance with R.61-58.17.J(2) of this section after exceeding treatment technique triggers in R.61-58.17.J(1)(a) and (1)(b).

(a) Level 1 treatment technique triggers.

(i) For systems taking 40 or more samples per month, the system exceeds 5.0% total coliform-positive samples for the month.

(ii) For systems taking fewer than 40 samples per month, the system has two or more total coliform-positive samples in the same month.

(iii) The system fails to take every required repeat sample after any single total coliform-positive sample.

(b) Level 2 treatment technique triggers.

(i) An *E. coli* MCL violation, as specified in R.61-58.17.K(1).

(ii) A second Level 1 trigger as defined in R.61-58.17.J(1)(a), within a rolling 12-month period, unless the Department has determined a likely reason that the samples that caused the first Level

1 treatment technique trigger were total coliform-positive and has established that the system has corrected the problem.

(iii) For systems with approved annual monitoring, a Level 1 trigger in two consecutive years.

(2) Requirements for assessments.

(a) Systems must ensure that Level 1 and 2 assessments are conducted in order to identify the possible presence of sanitary defects and defects in distribution system coliform monitoring practices. Level 2 assessments must be conducted by parties approved by the Department.

(b) When conducting assessments, systems must ensure that the assessor evaluates minimum elements that include review and identification of inadequacies in sample sites; sampling protocol; sample processing; atypical events that could affect distributed water quality or indicate that distributed water quality was impaired; changes in distribution system maintenance and operation that could affect distributed water quality (including water storage); source and treatment considerations that bear on distributed water quality, where appropriate (e.g., small ground water systems); and existing water quality monitoring data. The system must conduct the assessment consistent with any Department directives that tailor specific assessment elements with respect to the size and type of the system and the size, type, and characteristics of the distribution system.

(c) Level 1 Assessments.

A system must conduct a Level 1 assessment consistent with Department requirements if the system exceeds one of the treatment technique triggers in R.61-58.17.J(1)(a).

(i) The system must complete a Level 1 assessment as soon as practical after any trigger in R.61-58.17.J(1)(a). In the completed assessment form, the system must describe sanitary defects detected, corrective actions completed, and a proposed timetable for any corrective actions not already completed. The assessment form may also note that no sanitary defects were identified. The system must submit the completed Level 1 assessment form to the Department within 30 days after the system learns that it has exceeded a trigger.

(ii) If the Department reviews the completed Level 1 assessment and determines that the assessment is not sufficient (including any proposed timetable for any corrective actions not already completed), the Department must consult with the system. If the Department requires revisions after consultation, the system must submit a revised assessment form to the Department on an agreed-upon schedule not to exceed 30 days from the date of the consultation.

(iii) Upon completion and submission of the assessment form by the system, the Department must determine if the system has identified a likely cause for the Level 1 trigger and, if so, establish that the system has corrected the problem, or has included a schedule acceptable to the Department for correcting the problem.

(d) Level 2 Assessments.

A system must ensure that a Level 2 assessment consistent with Department requirements is conducted if the system exceeds one of the treatment technique triggers in R.61-58.17.J(1)(b). The system must comply with any expedited actions or additional actions required by the Department in the case of an E. coli MCL violation.

(i) The system must ensure that a Level 2 assessment is completed by the Department or by a party approved by the Department as soon as practical after any trigger in R.61-58.17.J(1)(b). The system must submit a completed Level 2 assessment form to the Department within 30 days after the system learns that it has exceeded a trigger. The assessment form must describe sanitary defects detected, corrective actions completed, and a proposed timetable for any corrective actions not already completed. The assessment form may also note that no sanitary defects were identified.

(ii) The system may conduct Level 2 assessments if the system has staff or management with the certification or qualifications specified by the Department unless otherwise directed by the Department.

(iii) If the Department reviews the completed Level 2 assessment and determines that the assessment is not sufficient (including any proposed timetable for any corrective actions not already completed), the Department must consult with the system. If the Department requires

revisions after consultation, the system must submit a revised assessment form to the Department on an agreed-upon schedule not to exceed 30 days.

(iv) Upon completion and submission of the assessment form by the system, the Department must determine if the system has identified a likely cause for the Level 2 trigger and determine whether the system has corrected the problem, or has included a schedule acceptable to the Department for correcting the problem.

(3) Corrective Action.

Systems must correct sanitary defects found through either Level 1 or 2 assessments conducted under R.61-58.17.J(2). For corrections not completed by the time of submission of the assessment form, the system must complete the corrective action(s) in compliance with a timetable approved by the Department in consultation with the system. The system must notify the Department when each scheduled corrective action is completed.

(4) Consultation.

At any time during the assessment or corrective action phase, either the water system or the Department may request a consultation with the other party to determine the appropriate actions to be taken. The system may consult with the Department on all relevant information that may impact on its ability to comply with a requirement of R.61-58.17, including the method of accomplishment, an appropriate timeframe, and other relevant information.

K. Violations

(1) E. coli MCL Violation.

A system is in violation of the MCL for E. coli when any of the conditions identified in R.61-58.17.K(1)(a) through (1)(d) occur.

(a) The system has an E. coli-positive repeat sample following a total coliform-positive routine sample.

(b) The system has a total coliform-positive repeat sample following an E. coli-positive routine sample.

(c) The system fails to take all required repeat samples following an E. coli-positive routine sample.

(d) The system fails to test for E. coli when any repeat sample tests positive for total coliform.

(2) Treatment technique violation.

(a) A treatment technique violation occurs when a system exceeds a treatment technique trigger specified in R.61-58.17.J(1) and then fails to conduct the required assessment or corrective actions within the timeframe specified in R.61-58.17.J(2) and (3).

(b) A treatment technique violation occurs when a seasonal system fails to complete a Department-approved start-up procedure prior to serving water to the public.

(3) Monitoring violations.

(a) Failure to take every required routine or additional routine sample in a compliance period is a monitoring violation.

(b) Failure to analyze for E. coli following a total coliform-positive routine sample is a monitoring violation.

(4) Reporting violations.

(a) Failure to submit a monitoring report or completed assessment form after a system properly conducts monitoring or assessment in a timely manner is a reporting violation.

(b) Failure to notify the Department following an E. coli-positive sample as required by R.61-58.17.I(2)(a) in a timely manner is a reporting violation.

(c) Failure to submit certification of completion of Department-approved start-up procedure by a seasonal system is a reporting violation.

L. Reporting and recordkeeping.

(1) Reporting.

(a) E. coli.

(i) A system must notify the Department by the end of the day when the system learns of an E. coli MCL violation, unless the system learns of the violation after the Department office is closed and the Department does not have either an after-hours phone line or an alternative notification procedure, in which case the system must notify the Department before the end of the next business day, and notify the public in accordance with R.61-58.6.

(ii) A system must notify the Department by the end of the day when the system is notified of an E. coli-positive routine sample, unless the system is notified of the result after the Department office is closed and the Department does not have either an after-hours phone line or an alternative notification procedure, in which case the system must notify the Department before the end of the next business day.

(b) A system that has violated the treatment technique for coliforms in R.61-58.17.J must report the violation to the Department no later than the end of the next business day after it learns of the violation, and notify the public in accordance with R.61-58.6.

(c) A system required to conduct an assessment under the provisions of R.61-58.17.J must submit the assessment report within 30 days. The system must notify the Department in accordance with R.61-58.17.J(3) when each scheduled corrective action is completed for corrections not completed by the time of submission of the assessment form.

(d) A system that has failed to comply with a coliform monitoring requirement must report the monitoring violation to the Department within 10 days after the system discovers the violation, and notify the public in accordance with R.61-58.6.

(e) A seasonal system must certify, prior to serving water to the public, that it has complied with the Department-approved start-up procedure.

(2) Recordkeeping.

(a) The system must maintain any assessment form, regardless of who conducts the assessment, and documentation of corrective actions completed as a result of those assessments, or other available summary documentation of the sanitary defects and corrective actions taken under R.61-58.17.J for Department review. This record must be maintained by the system for a period not less than five years after completion of the assessment or corrective action.

(b) The system must maintain a record of any repeat sample taken that meets Department criteria for an extension of the 24-hour period for collecting repeat samples as provided for under R.61-58.17.I(1)(a).

HISTORY: Added by State Register Volume 38, Issue No. 9, Doc. No. 4469, eff September 26, 2014.